

THIS FILE IS MADE AVAILABLE THROUGH THE DECLASSIFICATION EFFORTS AND RESEARCH OF:

THE BLACK VAULT

THE BLACK VAULT IS THE LARGEST ONLINE FREEDOM OF INFORMATION ACT / GOVERNMENT RECORD CLEARING HOUSE IN THE WORLD. THE RESEARCH EFFORTS HERE ARE RESPONSIBLE FOR THE DECLASSIFICATION OF THOUSANDS OF DOCUMENTS THROUGHOUT THE U.S. GOVERNMENT, AND ALL CAN BE DOWNLOADED BY VISITING:

[HTTP://WWW.BLACKVAULT.COM](http://www.blackvault.com)

YOU ARE ENCOURAGED TO FORWARD THIS DOCUMENT TO YOUR FRIENDS, BUT PLEASE KEEP THIS IDENTIFYING IMAGE AT THE TOP OF THE .PDF SO OTHERS CAN DOWNLOAD MORE!

On 12 February 2004, a team of officers, directed by Major General Antonio Taguba, conducted the following interview. Major General Taguba was appointed as an Investigating Officer under the provisions of Army Regulation 15-6, by Lieutenant General David D. McKiernan, Commanding General of the Coalition Forces Land Component Command (CFLCC), to look into allegations of maltreatment of detainees, detainee escapes and accountability lapses, at Abu Gharib, also known as the Baghdad Central Confinement Facility (BCCF). The panel also inquired into training, standards, employment, command policies, and internal policies, concerning the detainees held at Abu Gharib prison. Finally, the panel looked into the command climate and the command and supervisory presence.

The following persons were present.

COL [REDACTED] MP, CFLCC – PMO, Interviewer
LTC [REDACTED] JA, CFLCC – SJA, Interviewer
LTC [REDACTED] 705th MP Battalion, Interviewer
SFC [REDACTED] 372nd MP Company, Interviewee
SSG [REDACTED] 27D30, CFLCC – SJA, Recorder

The interview is summarized as follows:

My name is [REDACTED]. My social security number is [REDACTED]. I am a Sergeant First Class. I am currently with the 372nd Military Police Company, at Abu Gharib BCCF. I am Reserve.

My unit moved here from Al Hila, Iraq. Our mission there was law and order and combat support operations. About the middle of September 2003 we moved back to Kuwait for unit reorganization and resupply. In the beginning October 2003 we moved to the prison.

At the MOB station we trained on all combat support, to include battlefield circulation control, MSR control, Base defense, and a little bit of law and order. We didn't receive any training on our current mission.

I am the NCOIC of the hard site. The duties of personnel working there are to safeguard prisoners, make sure inmates receive meals on time, supervise Iraqi corrections officers (ICO's), and man the different wings of the prison.

Our day-to-day activities are governed by the Rules of Engagement (ROE). Our Rules of Engagement are can't shoot until prisoner reaches final barrier, shout, show, shoot, and use of minimum force necessary. We received a briefing at the MOB site on the Geneva Hague Convention, and customs of the country. The rules are not posted. I've tried to get some kind of policies from the Military Intelligence (MI), for MP's who work in the MI wing on what they expect the MP's to do. I've asked CPT [REDACTED] Chief [REDACTED] and CPT [REDACTED] the Jag officer who works with MI. I've asked months ago. CPT [REDACTED]

promised it to me, but then she went on leave and I assumed she forgot and I was never able to catch up with her.

MI issued the rules we followed, specifically for the MI wing. We received guidance from MI on altered diets, turning on and off of radio, and sleep management. At first we didn't keep documentation and then we started getting everything in writing signed by LTC [REDACTED] or Chief [REDACTED]. The requests were all laid out with times to do everything. It became a problem for us because it took away from normal health and welfare for the inmates. We were trying to get someone from MI to take care of the MI wing business, so that we could do our regular MP duties. I assumed they refused, but I never asked

The request were kept in the individual detainees folder, we have a folder for each cell. I don't know if they're still there or not because I have not been there for over a month. It is possible that MI could have taken the request, because they just sit in an MRE box on that wing. The MP NCOIC of the wing is in charge of the documents.

My role is to walk around visiting the soldiers making sure they are all right. I see if they needed a break or anything, if so I would take their spot until they got back. I would sit with the shift NCOIC to see if he needed anything, and would help him out. At the beginning we didn't have a computer in the office, so I did a lot of work in my office at the LSA typing up a spreadsheet listing the prisoners and what cells they were in.

I chose to alter my shift so that I could work with my day shift and my night shift. At times it got to be pretty rough as far as manning the prison with limited personnel. We made a request for more personnel through our company, CPT [REDACTED] he went up through the Battalion. As far as I know it went all the way up to the Brigade, and we got no help. We finally did get our second platoon up from Al Hila, they just came up maybe a week ago.

The battalion commander is LTC [REDACTED]. He comes down maybe 2 or 3 times a week, not necessarily in the prison but on the grounds. In the MI section we keep a log on as to who comes in and speaks to certain detainees. As far as the other sections we didn't keep a log, if there were a visitor coming in they were either escorted by CPT [REDACTED], CPT [REDACTED] or someone else from the Battalion.

I am aware of the allegations of the abuse of the detainees. Four of the soldiers involved belonged to my platoon. Only MP's worked the hard site. There was a mechanic involved who was doing maintenance to the generator and an admin clerk who worked for the battalion, who should have never been in there. It was a violation to let these individuals in.

I am not positive if MI asked the guards to do any of those things that occurred that night. Since this investigation we have been here so I am not exactly sure if anything has been done as far as mitigating so this doesn't happen again.

A few people did some things they knew they shouldn't have done. Posted or not, what I heard is not against Geneva Convention, it just against command policy. I don't care if it's written or not they should have none not to do that

There were conflicts between the MP's and MI. MI wanted to know why we wanted everything in writing. We needed everything in writing to keep everything flowing to make sure we didn't miss something. After a while we got to the point that we were almost being taken advantage of. They wanted us to do this and that, to escort the prisoners to their interrogation area, and to stand in on the interrogation. We didn't have enough personnel to do that, so we convinced them that they were going to have to escort their own detainees, and use their own people for interrogation.

I have never heard the term "softening up" used; I assume it means breaking down. I've heard MI saying that we have to break them down. I assume the term means break them down mentally to get them to speak free. It is my understanding that the orders MI handed down were legal. We tried to get limitations from MI on what we could and could not do, but we never received any.

We brought problems up to LTC [REDACTED] he said he would do the best he could. He was able to resolve a few problems such as power, we had a big problem with power and the reekyards, we were running four tiers running through 2 reekyards, so then they finally got a contract to get more reekyards.

We never got any SOP's from brigade. We never seen the Brigade Commander, the first time I seen her is when I got here and had to report to her. I don't know when she took over the brigade. I was transferred back to the 372nd back in February 2002. I've only seen her one time since the change of command back in June 2003. Her name is General Karpinski. The first time I seen the Brigade Sergeant Major is when I had to report to the general. I didn't know there was a change in SGM's, I didn't know the first SGM. There was a lack of Brigade presence at the facility. I don't know for sure, but I feel the Brigade had a lot to do with the problems associated with getting issues resolved at the prison.

I am a USAR soldier.

I am an electrician in my civilian career.

The MI wing is wing 1, where the security detainees are held, Wing 2,3,4,5, and 6 are regular inmate wings.

CPT [REDACTED] is the MI company commander, CPT [REDACTED] is the Judge Advocate for MI.

I submitted some operations matters to MAJ [REDACTED] who is with the MI unit under COL [REDACTED] specifically to get MI people into wing 1, 24 hours so that they could handle MI business.

I have known SPC [REDACTED] since February of 2003, but didn't know him very well, In October 2003 he was assigned to my platoon. He worked with SFC [REDACTED] who gave him a very good recommendation.

Weapons weren't allowed into 1A and 1B, until there was a serious force protection issue. We were receiving intelligence from Camp Vigilance and Camp Ganci about a plot to overthrow the guards at the prison.

The detainees were allowed 1 hour of recreation per day. CPA and ICO came up with the idea. It was only for wings 1-4, wing 1 didn't get any recreation time.

I chose to work a modified shift so that I can work with all my soldiers. I wanted to be able to interact with my night shift and my day shift.

CPT [REDACTED] was in charge of 1A and 1B until mid-December, he basically was the OIC of the hard site, and I was the NCOIC of the hard site. I lead the shift NCO's. I would be there for support if they needed anything. I visited 1A and 1B on a regular basis. When CPT [REDACTED] left CPT [REDACTED] asked me to keep an eye on 1A and 1B.

Orders came from LTC [REDACTED], but if I had a problem I would go through my operations or the company commander depending on the situation, then up the chain to MAJ [REDACTED] then to LTC [REDACTED].

The panel gave SFC [REDACTED] a list of items, to be addressed, and be written on a Sworn Statement.

SWORN STATEMENT

For use of this form, see AR 190-45; the proponent agency is ODCSOPS

PRIVACY ACT STATEMENT

AUTHORITY: Title 10 USC Section 301, Title 5 USC Section 2951; E.O 9397 dated November 22, 1943 (SSN)
PRINCIPAL PURPOSE To provide commanders and law enforcement officials with means by which information may be accurately
ROUTINE USES Your social security number is used as an additional/alternate means of identification to facilitate filing and
DISCLOSURE Disclosure of your social security number is voluntary

1 LOCATION CAMP VICTORY, IRAQ	2 DATE (YYYYMMDD) 2004/2/12 2004/2/12	3 TIME	4 FILE NUMBER
5 LAST NAME FIRST NAME MIDDLE NAME	6 SSN	7 GRADE/STATUS E7	
8 ORGANIZATION OR ADDRESS			

9 I, _____, WANT TO MAKE THE FOLLOWING STATEMENT UNDER OATH

Q WHO WAS IN CHARGE OF THE HARD SITE?
A CPT _____ WAS IN OIC OF THE HARD SITE AND CAMP VIGILANT THE CPA WAS ULTIMATELY IN CHARGE OF THE HARDSITE

Q DESCRIBE THE RELATIONSHIP BETWEEN MI AND MP IN WINGS 1A AND 1B WHO'S ORDERS TOOK PRECEDENCE?
A THE RELATIONSHIP BETWEEN MI AND MP WAS A VERY GOOD WORKING RELATIONSHIP FOR THE FIRST TWO MONTHS MI WAS VERY PLEASED WITH THE MP'S PERFORMANCE THEN MI PERSONNEL BEGAN TO EXPECT THE MP'S TO DO MORE AND MORE FOR EXAMPLE ENFORCEMENT OF FOUR DIFFERENT SLEEP MANAGEMENT PLANS FOR FOUR DIFFERENT DETAINEES, PLUS TAKING SPECIAL CARE OF TWO DETAINEES THAT WERE ON MI'S "GOOD GUY" LIST THE MP'S STARTING REQUESTING THAT ALL INSTRUCTIONS BE PUT INTO WRITING, WHICH SEEMED TO FRUSTRATE SOME OF THE MI PERSONNEL ORDERS FROM THE 320TH MP BN TOOK PRECEDENCE FOR THE MP'S WORKING IN WING 1. THERE WERE A FEW CONFLICTS OF INTEREST, WHEN THIS OCCURRED THE MP'S WOULD HAVE THE MI OPERATIONS CHIEF CONTACT THE 320TH SO THAT THE TWO COMMANDS COULD WORK OUT THE SITUATION

Q DESCRIBE THE ORDERS, HOW WERE THEY RECEIVED, WHO SIGNED THEM, WHERE WERE THEY KEPT
A THE ORDERS THAT WE RECEIVED, PRIMARILY SLEEP MANAGEMENT SCHEDULES, WERE HAND CARRIED TO WING 1 BY A SOLDIER FROM MI, USUALLY THE DETAINEES HANDLER THAT THE SCHEDULE WAS FOR IT WOULD INCLUDE TIMES THAT THE DETAINEE WAS TO BE AWAKE, WHEN HE WAS TO SLEEP, WHEN HE WAS TO BE GIVEN A MEAL AND WHEN THE MEAL WAS TO BE TAKEN AWAY THESE WRITTEN ORDERS WERE SIGNED BY EITHER COL PAPAS OR CHIEF _____. THEY WERE AND, IF THE DETAINEE IS STILL BEING HELD THERE, SHOULD STILL BE WITH THE DETAINEES FILE ON WING 1

Q DID MI GIVE ANY ORDERS, WRITTEN OR ORAL AGAINST THE GENEVA CONVENTION?
A YES, AN ORAL ORDER WAS GIVEN TO ONE OF THE MP'S BY AN MI SOLDIER TO "STRIP THE CELL" OF A SPECIFIC DETAINEE THIS WAS TO INCLUDE CLOTHING AND BEDDING WHEN THIS WAS BROUGHT TO THE ATTENTION OF CHIEF RIVAS HE IMMEDIATELY HAD IT CHANGED

Q DID MI GIVE ORDERS TO USE PHYSICAL VIOLENCE?
A NOT TO MY KNOWLEDGE

Q DESCRIBE SUPERVISORY CLIMATE WHO ELSE WOULD VISIT WING 1
A LTC _____ AND/OR CHIEF _____ WOULD VISIT WING 1 ALMOST DAILY AT RANDOM TIMES. CPT _____ ALSO VISITED DAILY AT RANDOM TIMES LTC _____ CPT _____ SGM _____ CSM _____, 1ST SGT _____ ALSO VISITED QUITE OFTEN CSM _____ FROM MI CAME IN WITH LTC _____ ON SEVERAL OCCASIONS AND COL _____ RECENTLY BEGAN TO VISIT MORE OFTEN

10 EXHIBIT	11 INITIALS OF PERSON MAKING STATEMENT	PAGE 1 OF 2 PAGES
------------	--	-------------------

ADDITIONAL PAGES MUST CONTAIN THE HEADING "STATEMENT _____ TAKEN AT _____ DATED _____
THE BOTTOM OF EACH ADDITIONAL PAGE MUST BEAR THE INITIALS OF THE PERSON MAKING THE STATEMENT AND PAGE NUMBER MUST BE BE INDICATED

STATEMENT OF

[REDACTED]

TAKEN AT CAMP VICTORY

DATED 2004/02/12

9 STATEMENT (Continued)

Q: DESCRIBE ACTIONS TAKEN TO ELIMINATE SOME PROBLEMS

A: AFTER THE SHOOTING INCIDENT IN WING 1/A THE REQUEST WAS SUBMITTED THROUGH THE CHAIN OF COMMAND TO HAVE THE UPPER WINDOWS BOARDED UP IT WAS FOUND THROUGH INVESTIGATION THAT THE PISTOL AND KNIVES WERE RECEIVED BY THE DETAINEE FROM AN ICO THROUGH THE TOP TIER WINDOW THE WINDOWS WERE SOON COVERED THIS ALSO HELPED FOR COMFORT OF THE DETAINEES BECAUSE THERE IS NO HEAT IN THE HARDSITE AFTER AN ESCAPE OF TWO INMATES FROM WING 3/A THROUGH A WINDOW AND UNFENCED AREA, MORE PRESSURE WAS PUT ON THE IRAQI CONTRACTOR FROM THE COMPANY AND BATTALION TO INSTALL MORE FENCING WHICH INCLUDED ADDITION RECREATION YARDS. THE REQUEST FOR THE RECREATION YARDS HAD BEEN SUBMITTED SEVERAL TIMES TO THE CPA, THERE WERE FOUR WINGS OF INMATES (APPROXIMATELY 600 DETAINEES) TO CYCLE THROUGH TWO REC YARDS EACH DAY DURING A POWER OUTAGE AT NIGHT A REQUEST WAS PUT IN TO THE BATTALION FOR OUTDOOR LIGHTING PORTABLE LIGHTING WAS BROUGHT IN WITHIN 30 MINUTES WHEN DETAINEE SUPPLIES BECAME EXTREMELY LOW BECAUSE THE CPA WASN'T ABLE TO, OR JUST DIDN'T SUPPLY THE HARDSITE WITH THE BASIC NEED ITEMS, I ASKED, THROUGH CPT REESE, THE BATTALION FOR SOME SUPPLIES THE BATTALION USED THEIR SUPPLY SYSTEM WHICH SUPPLIED CAMP VIGILANT AND CAMP GANCI, TO SUPPLEMENT THE HARDSITE UNTIL THE CPA WAS ABLE TO COME THROUGH WITH THOSE NEEDED ITEMS ////////////////END OF STATEMENT//////////

AFFIDAVIT

I, [REDACTED], HAVE READ OR HAVE HAD READ TO ME THIS STATEMENT WHICH BEGINS ON PAGE 1, AND ENDS ON PAGE 2. I FULLY UNDERSTAND THE CONTENTS OF THE ENTIRE STATEMENT MADE BY ME. THE STATEMENT IS TRUE. I HAVE INITIALED ALL CORRECTIONS AND HAVE INITIALED THE BOTTOM OF EACH PAGE CONTAINING THE STATEMENT. I HAVE MADE THIS STATEMENT FREELY WITHOUT HOPE OF BENEFIT OR REWARD WITHOUT THREAT OF PUNISHMENT, AND WITHOUT COERCION, UNLAWFUL INFLUENCE, OR UNLAWFUL INDUCEMENT.

[REDACTED]

(Signature of Person Making Statement)

WITNESSES

Subscribed and sworn to before me, a person authorized by law administer oaths, this 12 day of FEB, 2004 at CAMP VICTORY, IRAQ

[REDACTED]

(Signature of Person Administering Oath)

ORGANIZATION OR ADDRESS

(Typed Name of Person Administering Oath)

PLT 136 UMI

(Authority To Administer Oaths)

ORGANIZATION OR ADDRESS

INITIALS OF PERSON MAKING STATEMENT

[REDACTED]

PAGE 2 OF 2 PAGES

On 9 February 2004, a team of officers, directed by Major General Antonio Taguba, conducted the following interview. Major General Taguba was appointed as an Investigating Officer under the provisions of Army Regulation 15-6, by Lieutenant General David D. McKiernan, Commanding General of the Coalition Forces Land Component Command (CFLCC), to look into allegations of maltreatment of detainees, detainee escapes and accountability lapses, at Abu Gharib, also known as the Baghdad Central Confinement Facility (BCCF). The panel also inquired into training, standards, employment, command policies, and internal policies, concerning the detainees held at Abu Gharib prison. Finally, the panel looked into the command climate and the command and supervisory presence.

The following persons were present:

COL [REDACTED] MP, CFCC – PMO, **Interviewer**
LTC [REDACTED] JA, CFLCC – SJA, **Interviewer**
LTC [REDACTED] 705th MP Battalion, **Interviewer**
SFC [REDACTED] 372nd MP Company, **Respondent**
SSG [REDACTED] 27D30, CFLCC – SJA, **Recorder**

The interview is summarized as follows:

My name is [REDACTED] Sergeant First Class, acting First Sergeant, 372nd Military Police Company, United States Army Reserve, 23 years, social security number, [REDACTED]. I've been with the 372nd for 20 years, acting First Sergeant for 2 weeks. I've been placed in this position, due to the fact that the First Sergeant has been suspended from duties, pending the outcome of the investigation into allegations of prisoner abuse at Baghdad Correctional Facility.

My assessment is that morale is stable. We have 54 days left, before we re-deploy to Kuwait, so people are upbeat. There's a lot of negativity in the Command Climate, because people feel that the Commander, and SFC [REDACTED] are being made sacrificial lambs for something they had no control over. Other than that we're proceeding on with the mission, doing the job and getting it done.

We've had a sensing session with the Chaplain, and the Sergeant Major's come out, sat down and talked to people. The problem is with the shifts – you can't get everybody out with the odd hours. We've tried. Combat Stress Team has been out, to talk to the unit. I give everybody the opportunity to talk to me, at anytime, and they know that.

We're writing the SOP's, which in my personal opinion, is totally wrong. SOP's should be handed down to us. We are a Combat Support MP Company. We're not I/R. We're not EPW. As far as our training, we pick them up off the battlefield. We take them to a holding area. We drop them off. An Escort Guard Company comes, and they take them back to the holding area. I don't feel, that we are qualified, to write SOP's on how to handle civilian detainees.

At the MOB Station, we basically did our Combat Support Training – running MSR patrols, route re-cons, and area security. I had no idea that we would be doing the mission we're doing now. The EPW training, you deal with handcuffing, transporting detainees, and dropping them off. But, other than that, it's very limited.

A new soldier in Tier 1A would receive about 2 days worth of training from the NCOIC of the Tier, before he would be allowed to be there by himself. Even at that time, because Tier 1A is an MI Hold section. There are always 3 people on duty. The training is OJT. They go up there, they work, they observe, they see how things operate.

We're meeting the minimum manpower requirements right now. At the hard site, it's all MP's. At Camp Vigilant, I have one cook out there. She mans the tower. She has no direct contact with the detainees. She received training from the NCOIC of Vigilant, SFC [REDACTED]. Before he lets anybody go to work, he makes sure they receive training on how to deal with the detainees that are in his site, and that includes other MP's. I know there are other units that are very short, because of REFRAD's.

I check my soldiers everyday and every night.

I understand that there was a CD Rom dropped off at CID, with photographs on it, and that's how this whole thing started. I know the boy who did it. I don't blame him for doing it. I just wish he went to his chain of command. Apparently, the individuals who are under investigation for this matter decided to pass CD's around.

If it were brought to my attention, and I have some knowledge of what's on the pictures, because I saw them, during the first investigation, there's no doubt in my mind that those people would be relieved and facing charges, just like they are now.

Most of the escapes or attempted escapes, about 99%, have been at the hard site. At the hard site, you're dealing with the ICO's. We've had an incident where an ICO actually smuggled a weapon in. He shot an MP. Just the other day, we had an ICO smuggling in clothes to a prisoner, to try and help him escape. We had, just this week, 3 attempted escapes.

When an inmate is caught, trying to escape, he is put in isolation, the Tier is locked down, and he gets no cigarettes, no privileges for a week. There have been no coordinated escape attempts.

I feel that these were individual actions. If individuals choose not to do the right thing, I can stand there and harp all day, if they don't want to do that, it's not going to change their attitude. From what I've seen, and what I've heard, this was a failure of human decency.

The Geneva Hague Convention is part of your yearly mandatory training. You have to have 100% signed in. I don't know why it's not posted at the facility. It should be

We had, what I thought, was a very good relationship with the MI people that were running 1A, 1B. There were a lot of things that were done by word of mouth. That has changed. My MPs have been instructed, they will not do anything, unless it's in writing. From what I was told it would have to be approved by the O6 from the MI. They had us doing their sleep deprivation, and I have no problem doing that, but you will put it in writing. My soldiers have been instructed, as far as that's concerned, that would be as much as walking by their cells, telling them to wake up. They're not touching anybody. After everything that has come down, my soldiers will question.

I believe people just took it to a level they wanted to. There's no doubt in my mind, that if somebody told me to do the things purported to have been done, it's definitely an illegal order. It's definitely an immoral order.

To get right? First of all, the hard site is a CPA function. The CPA needs to be doing their job. We are beating our heads against the wall, with ICO's, who have gone through a 2-week course. That disturbance, yesterday, Tier 5, we have 7 CPA guys out there, telling us what we should do, and it's not us who should be doing it. It's the CPA's facility, the ICO's facility. The Iraqis should be the one who are doing it, but when push comes to shove, it's thrust upon us to do. One day we're not going to be there. These people need to start picking up the ball, and doing their jobs.

Number 2, this REFRAD crap, I understand it's the law, but it's tearing units apart. You're winding up with units that are short of personnel. We're lucky right now. We have enough people to get the job done. I have 5 REFRADs scheduled this month. There's another 5 MP's, that I'm gonna lose, and eventually it's going to get to the point where I'm not going to have a choice - I'll wind up having to pull a mechanic or a cook. They won't be in direct contact with inmates, but they're going to work somewhere else.

These REFRAD's are for the 22 - 24 month rule. They've been on active duty 2 years, because of Homeland Defense Measures. I realized Congress passed the law, but we need to look at getting that straightened out. It's hurting, not just my unit, but a whole lot of other units. There needs to be systems like the active army - you lose somebody, you can get somebody. I have prior service people sitting back in the states, that could have possibly been pulled over to fill slots that are vacant, but there's no mechanism to do that. In the Reserves you deploy with what you have, and when they're gone, there's no replacement.

I have seen General Karpinski 2 or 3 times. She was hanging her hat, here at Victory. I'm an old school guy. I believe you lead from the front, not from the back. I have seen the new commander, COL [REDACTED] about four times already, and the Sergeant Major Butler is out, constantly. He's only been here a few weeks. There's a major difference in the support we're getting. They volunteer to find a way to fix things.

The biggest issue, logistics – getting the basic things for our soldiers, boots and uniforms, has turned into such an ordeal. If you can't get soldiers what they need to survive, you're failing them.

Unfortunately Sir, most our logistical support I did. The only place you can get anything, it seems, is Arifjan. If you move S4 forward, then you run into the problem of them having to go down and get things for you, and it turns into a nightmare. Right now, because of doing a little horse-trading, and the companies pooling assets, our vehicle readiness is about 90 – 92%, which is outstanding in the conditions we're in. But, it took a lot of pooling to get it that way. Everybody's been out working their own side deals, so the soldiers are getting what they need, but working it through the normal channels doesn't work. It was the same in Desert Storm. You have to "wheel and deal." This time it's been deplorable this time.

CSM [REDACTED] I saw quite a bit. He was always there, and very much a troops-oriented person.

The panel stopped, to discuss SFC [REDACTED] statements.

Finished with their discussion, the panel gave SFC [REDACTED] a list of items, to be addressed, and brought back on a Sworn Statement.

SWORN STATEMENT

For use of this form, see AR 180-45, the proponent agency is ODCSOPS

PRIVACY ACT STATEMENT

AUTHORITY Title 10 USC Section 301, Title 5 USC Section 2951, E.O. 9397 dated November 22, 1943 (SSN)
PRINCIPAL PURPOSE To provide commanders and law enforcement officials with means by which information may be accurately identified
ROUTINE USES Your social security number is used as an additional/alternate means of identification to facilitate filing and retrieval
DISCLOSURE Disclosure of your social security number is voluntary

1 LOCATION Camp Victory Iraq
2 DATE (YYYYMMDD) 2004/02/09
3 TIME
4 FILE NUMBER
5 LAST NAME, FIRST NAME, MIDDLE NAME
6 SSN
7 GRADE/STATUS E7 Active
8 ORGANIZATION OR ADDRESS 372nd Military Police Company Abu Gurab Iraq

9 I, [redacted] WANT TO MAKE THE FOLLOWING STATEMENT UNDER OATH
Q What kind of training did unit receive at home station?
A Unit training is based on MTP 19-313-30 and MTP 19-313-10 for Combat support MP companies
Q What kind of training did unit receive at Mob Station?
A Units training was based on combat support Military Police taskings MSR security, Area Security, Dealing with displaced persons civilian refugee
Q What kind of training has unit received in theater?
A Unit received left seat right side training from 72nd MP CO when we relieved them ROE training less lethal training, Riot control, cell extraction
Q How is unit making minimum manpower requirements?
A Soldiers are working 12hr shifts with limited time off HQ personnel are being tasked with escort missions when MP assets are not available Have non MP soldiers in Towers that do not have direct detainee contact There are no NON 31B soldiers at the hardsite
Q If supervisors performed random checks at irregular hours how did Acts occur?
A People picked their times apparently stopped when people came around and continued actions once they left
Q How did MI Break New detainees?
A Detainees were brought in subject to sleep deprivation, cold showers every 30 mins cuffed and forced to stand for long periods of time and PT ie push-ups side straddle hops etc
Q What was the relationship between MI and MPs?
A We had a very good working relationship MI brought detainees in and handled interrogations and punishments MP s maintained custody and control and tried to assist when needed
Q Was direction on how to deal with detainees given either verbally or in writing?
A Very little was ever put in writing until recently when it was requested mostly verbally
Q What types of disciplinary actions have been conducted by the unit?
A As of this date 14 Article 15's 4 of which are suspended 3 pending Counseling statements are numerous Corrective training to not being in proper uniform ie helmet etc Has been done
Q Is there a conception in the Unit that misconduct will be tolerated?
A With the article 15's and the other actions that have taken place I think the majority of the unit knows action will be taken

[redacted] NOT USED [redacted]

10 EXHIBIT
11 INITIALS OF PERSON MAKING STATEMENT
PAGE 1 OF 1 PAGES

ADDITIONAL PAGES MUST CONTAIN THE HEADING "STATEMENT OF [redacted] TAKEN AT [redacted] DATED [redacted]
THE BOTTOM OF EACH ADDITIONAL PAGE MUST BEAR THE INITIALS OF THE PERSON MAKING THE STATEMENT AND PAGE NUMBER MUST BE INDICATED

STATEMENT OF [REDACTED] TAKEN AT Camp Victory DATED 10/26/17

9 STATEMENT (Continued)

NOT USED

AFFIDAVIT

I, [REDACTED] HAVE READ OR HAVE HAD READ TO ME THIS STATEMENT WHICH BEGINS ON PAGE 1 AND ENDS ON PAGE 1 I FULLY UNDERSTAND THE CONTENTS OF THE ENTIRE STATEMENT MADE BY ME THE STATEMENT IS TRUE I HAVE INITIALED ALL CORRECTIONS AND HAVE INITIALED THE BOTTOM OF EACH PAGE CONTAINING THE STATEMENT I HAVE MADE THIS STATEMENT FREELY WITHOUT HOPE OF BENEFIT OR REWARD WITHOUT THREAT OF PUNISHMENT AND WITHOUT COERCION UNLAWFUL INFLUENCE OR UNLAWFUL INDUCEMENT

[REDACTED]
(Signature of Person Making Statement)

WITNESSES

Subscribed and sworn to before me a person authorized by law to administer oaths this 10th day of February 2017 at Victory Camp

[REDACTED]
CFAC-CT-OSD

[REDACTED]
(Signature of Person Administering Oath)

ORGANIZATION OR ADDRESS

[REDACTED]
(Typed Name of Person Administering Oath)

ORGANIZATION OR ADDRESS

[REDACTED]
(Authority To Administer Oaths)

INITIALS OF PERSON MAKING STATEMENT

PAGE 0 PAGES

On 12 February 2004, a team of officers, directed by Major General Antonio Taguba, conducted the following interview. Major General Taguba was appointed as an Investigating Officer under the provisions of Army Regulation 15-6, by Lieutenant General David D. McKiernan, Commanding General of the Coalition Forces Land Component Command (CFLCC), to look into allegations of maltreatment of detainees, detainee escapes and accountability lapses, at Abu Ghraib, also known as the Baghdad Central Confinement Facility (BCCF). The panel also inquired into training, standards, employment, command policies, and internal policies, concerning the detainees held at Abu Ghraib prison. Finally, the panel looked into the command climate and the command and supervisory presence.

The following persons were present:

COL [REDACTED], MP, CFLCC - PMO, Interviewer
LTC [REDACTED], JA, CFLCC - SJA, Interviewer
LTC [REDACTED], 705th MP Battalion, Interviewer
SSG [REDACTED], HC, 320th MP Battalion, Interviewee

The interview is summarized as follows:

My name is Staff [REDACTED]. My social security number is [REDACTED]. I am currently in 372nd Military Police Company out of Fort Meade, MA. I am Reserve. My unit currently works at the Abu Ghraib Prison. I have served with this unit 2 years. I am Squad Leader in the unit and I have been in that position since September 2003.

My role as a Squad Leader and Assistant NCOIC is to keep accountability of inmates, maintain account board, receive new prisoners, the in processing and out processing of inmates, recording information to log into system, report prison security and maintenance problems, and all other transactions regarding prisoners.

I have personnel that work for me at the prison. I worked out of the office and my personnel worked at various sites throughout the prison. I have personnel that worked on the night shift back in December who are involved in the allegations of prisoner abuse. The personnel are Staff Sergeant [REDACTED], Specialist [REDACTED], Specialist [REDACTED], and Specialist [REDACTED]. The guards post are the Military Intelligence Hold, Medical Section, and Common Criminals Section.

The unit had a general overall SOP, but not a specific SOP regarding handling and disciplining inmates. We have had the Geneva Convention briefing before we left home station back in April 2003. Military Intelligence had separate policies regarding treatment of prisoners.

If Military Intelligence gave us orders to perform certain acts (sleep deprivation, playing radio all night, have inmate stand up all night) towards inmates, I requested that it be put in writing. If we were ever questioned why we were doing certain acts to the inmates we would always have the letter from Military Intelligence. We would interrupt the

performed acts if the inmate had immediate needs in regards to the Geneva Convention Act. The letters we received from Military Intelligence regarding acts performed on inmates can be found at their Tier 1A section, SGT [REDACTED] is the point of contact.

I work in a different section now, I was moved due to the investigation. I didn't have a problem being moved, because if I were under investigation I'd rather not work in that same section. I feel if I were still working that section my judgment would be affected, because I would always be thinking about the investigation.

I am not familiar with the ROE interrogation card, I believe I've seen a briefing or memorandum, but never trained on it. Before this mission we did a Law and Order mission in which we did a great job, we are a combat support unit we have done peacekeeping in Bosnia, so we have had experience in maintaining law and order. We were put in the rear to handle this mission, but we are not corrections officers. We haven't had any corrections training. That is still no excuses for what happened.

I was not around when the allegations happened. I was very offended to have my name mentioned in the allegation. I've never conducted myself in that manner or even been involved in anything that comes close to this. When I was involved in the shooting incident, when the prisoner stopped shooting, I stopped shooting. I then made sure a Medivac was called in for the inmate that I had wounded.

We have worked hard to maintain our prison. We have a couple of incident reports we have pulled so you look at to see what we have been doing to make the prison a better place. The biggest problem we have with the prison is the CPA, they have hired 5 or 6 Iraqi corrections officers who after investigation were found out to be Fedayeen. We have Fedayeen working in the jail cells, that's a hiring and screening issue. The hired Iraqi corrections officers have no training, not even the basics. I have stressed the importance of searching inmates properly, it's a daily process that we have to go through. CPA has never once come down to visit the prison. We have asked for support as for as equipment, uniforms, and cleaning supplies. I had to go out on the economy to buy cleaning supplies for the first three months.

The ICO's were never trained. Most of them are corrupt. We had to detain 41 of them during the shooting incident. We had to change everything around after the incident. They don't communicate, they don't have accountability, it just a mess.

We have had some support from our higher. We had an issue with inmates not going to court, we brought it up with JAG, specifically CPT [REDACTED] and then a lot of the inmates started to see the judge and started getting released. Then we had another breakdown of people not moving, not getting to court, I think it was due to units leaving, transport issues around November through December, but then it got fixed.

I don't know the Battalion Commander's involvement in the process of getting supplies, equipment, and support. I just know when we asked for supplies we didn't get them. I

don't know what was done or what wasn't done, so it wouldn't be fair for me to comment. It would be something my OIC would know more about

Our chain of command did come to visit, I would see MAJ [REDACTED] Chief [REDACTED] COL [REDACTED], almost daily. There were also Military Intelligence officers that would come down

We used our dogs to sniff out grenades, we had reports of grenades getting in the facility. Then after the shooting we had them search for bombs. Some of the inmates would tell us about grenades getting into the hard site. The dogs were also used as a show of force. I did hear about an interpreter getting bit, I think MI used the dogs for interviewing purposes

When MAJ [REDACTED] came to the facility I would be busy. He would come to talk to us, but he would usually talk with the platoon sergeants.

Our correction training was basically OJT since day one. We have three personnel who worked corrections before who are Staff Sergeant [REDACTED], Corporal [REDACTED], and Staff Sergeant [REDACTED]. I never worked in corrections. We referred to SSG [REDACTED] a lot he was very knowledgeable

There were no SOP's from higher or we never seen them. We basically got guidance from the unit we took over for. We were just picking up from the way that they did things

We knew things were not supposed to be the way they were, like having juveniles and females in the military holds. We also fought all the time with MI and Battalion about common criminals being in the military hold areas. We were stuck in the middle. That battle went on for months, we knew there were guidelines, but it was above our pay grades we just did as we were told

MAJ [REDACTED] would say we run the prison not MI. I knew that you should not have common criminals in the MI hold, because the common criminals would soon be released and they could tell who they saw in the MI holds. I would advise MAJ Dinenna of this. There was room in the facility to properly categorize the inmates

We worked for Battalion the Battalion owned the facility. I don't know how MI fitted in to the scheme, I didn't know the chain of authority. It was a unique situation we had, the MI Colonel who we took orders from and we had the Battalion who we took orders from it just depended who was around at the time. It was my job to carry out the orders, not to second guess them

Sometimes we had problems with prisoners being released that weren't suppose to be released. We would have to double check with MI to see if they still needed the prisoners that were scheduled for release

The panel stopped, to discuss SSG ██████ statements

The panel reconvened

Weapons were allowed in 1A and 1B, before the shooting incident we did weapons, but after the incident weapons were allowed. Also, after that we had a threat from the Iraqi corrections officers, who we received info that the ICO's were planning an attack on the prison involving guns and explosives

Also access control was a problem in 1A and 1B, there wasn't a roster. We would ask for identification if we didn't recognize the person who was trying to enter, but most of the time they would be with MI

We couldn't do anything we wanted to do the detainees, but there wasn't anything listed as far as limitations. We just used common sense

I was never asked to do anything that would violate the Geneva Hague Conventions, I can't speak for my soldiers, but no of them never came to me about anything out of the way

I think the incidents had to do with the individuals, sometime you have personnel that in the unit that have behavioral problems. There were no previous disciplinary incidents on the individuals who were involved, that I am aware of, I thought they were chosen because of their corrections officer experience

I can't remember the Battalion Commander's name at this time

I would like to reiterate on the support issue. Some officers from Battalion did support us. CPT Avery, and another CPT. They would listen to us, now that was good; I would talk to anyone who would listen. I just wanted to make sure that it was noted that some people did take some interest in the situation

Finished with their discussion, the panel gave SSG Elliott a list of items, to be addressed, and brought back on a Sworn Statement

On 12 February 2004, a team of officers, directed by Major General Antonio Taguba, conducted the following interview. Major General Taguba was appointed as an Investigating Officer under the provisions of Army Regulation 15-6, by Lieutenant General David D. McKiernan, Commanding General of the Coalition Forces Land Component Command (CFLCC), to look into allegations of maltreatment of detainees, detainee escapes and accountability lapses, at Abu Ghraib, also known as the Baghdad Central Confinement Facility (BCCF). The panel also inquired into training, standards, employment, command policies, and internal policies, concerning the detainees held at Abu Ghraib prison. Finally, the panel looked into the command climate and the command and supervisory presence.

The following persons were present:

COL [REDACTED], MP, CFLCC – PMO, Interviewer
LTC [REDACTED], JA, CFLCC – SJA, Interviewer
LTC [REDACTED], 705th MP Battalion, Interviewer
SGT [REDACTED], 320th MP Company, Interviewee
SSG [REDACTED], 27D30, CFLCC – SJA, Recorder

The interview is summarized as follows:

My name is [REDACTED]. My social security number is [REDACTED]. I am a Sergeant. I am currently with the 320th Military Police Company, at Abu Ghraib BCCF. I am Active Duty.

My job here is to help secure all the compounds and I also help out the 82nd with providing over watch and support. I arrived here at the facility around Mid-November 2003. I worked at the Camp Doha customs facility before I arrived here at Abu Ghraib.

We use AR 190-12 for the performance of our duties. The regulation covers the training of military working dogs. I'm not sure what policy covers use of force for military working dogs.

I haven't been trained on Geneva Hague Convention. I know it is the rules governing the law of warfare. Basically it covers treating people with respect and dignity, I can't recall where I heard about it at.

My duties with the hard site are to patrol, provide security, and search cells whenever needed. We mainly patrol Camp Ganai. We are hardly ever used at the hard site. There is no need for to be in the hard site, and I've tried to explain that before. The SOP originally didn't have much guidance for the dog handlers. The SOP changed to have dog handlers in the hard site when I was put under investigation a couple of weeks ago.

I am in charge of the Army dogs here. We also have Navy dogs here. There isn't a NCOIC for the dogs program as a whole, because the Army and the Navy perform different duties. The navy dogs work ECP's and they work with the IRF. MA1 [REDACTED]

is the senior dog handler. There is no link between the navy and us. Our chain of command is in Baghdad. I don't think we should be used together, because there are too many difference in the way we do things. Only time we work together is for escapes, but it is not the norm that we work together.

The navy supposedly works for MI, but that is the problem since we been here nobody knows who's in charge of what. The people who are in charge try to tell you how to do your job, even though they're not trained in dog handling.

We work for the S-3, MAJ [REDACTED]. We fall under him, but we know that our mission is to patrol the compounds everyday. We have no set schedule, we base our work times based on how the dogs feel.

We no longer work the hard site because of the investigation. I made a statement to CID regarding my involvement in the abuse and maltreatment of detainees. In December 2003 my dog bite a detainee. I talked to CID and I'd rather not discuss the incident.

We were at the site because it is a patrol area, we were on patrol when the incident happened. LTC [REDACTED] signed an SOP stating that we are suppose to be a physical and psychological deterrent in the hard site and the rest of the compounds.

I expressed to CPT [REDACTED] and MAJ [REDACTED] that the dogs shouldn't be used in the hard site, right after the SOP came out. CPT [REDACTED] is the assistant S-3. They told me that it is a patrol area and SOP directs it. I told them nothing good is going to come out of dogs being in a hard site.

I was not ordered to release my dog, I can't explain the incident because it is an ongoing investigation.

When we arrived we were having problems with electricity, lights, and our heating system. We haven't had much support if any on our request.

I told the S-3 officers that I would write some changes down that needed to be made. We need a vehicle because the weather is getting hotter, we need a kennel for all the dogs, and we need a veterinarian here. I've expressed my concerns to SGM [REDACTED], CPT [REDACTED], MAJ [REDACTED], and my kennel master in Baghdad, SSG [REDACTED].

I was involved in one escape. We scoured the fields, but we didn't find the detainee. We figured where he got out of the cell. We saw that he escaped by jumping from one of the guard's towers. No improvements have been made since the last escape in January. I think the escape that it was from the hard site. Rumor has it that the escapee was one of the IP's cousins.

One of the things that bothers me is that I have saw the detainees get hired here as an interpreter and things happen here all the time like that. Contractors are allowed to go anywhere they want without escorts. We've had problems with contractors stealing from

the soldiers. Another thing that bothers me is that when you go into the Ganci compound you are not allowed to carry weapons.

The detainees run this place we don't, they pretty much do what they want. Soldiers have to bribe the detainees with cigarettes to get them to come out of their tents in the morning. The detainees make shanks and knives and threatened to use them. They have radios, they told us that Saddam was captured.

For hostage situations they have an IRF, but I don't think they are trained or have any plan that they would follow.

I don't know of any other MOS's working in Tier 1A and 1B. I think MP's were the only personnel around when I had the biting incident with my dog.

I have no confidence in the abilities of my leadership, because I don't think I could trust half of these people to take care of me in a combat situation. I feel this way based on the lack of support that we have had, and people trying to tell us how to do our job without having a clue what our job consist of.

My blood type is B negative. I am assigned to HHC, 320th MP Company.

AR 190-12 covers military working dogs. I am not familiar with AR 190-14. I am a 31B. I am not familiar with AR 190-8.

My dog's name is Duko, I have been with Duko for two years. I've been a dog handler since 2001.

We have ROE concerning our dogs. The ROE that covers the use of dogs is in the SOP.

We do shakedown inspections, but I couldn't tell you how often we do them.

I have one other soldier that works with me.

I purchased my own body Armour, because I was issued a flak vest from Fort Bragg. I was given body Armour in Arifjan, but I gave it to my soldier because he was issued a flak vest also.

Finished with their discussion, the panel gave SGT [REDACTED] a list of items, to be addressed and brought back on a Sworn Statement.

The use of military police dogs is governed by AR 190-12, the utilization of military working dogs, training, general purpose, and requiring of The kennel master is SSG [REDACTED], he is the senior member for army dogs.

The use of force is governed under AR 190-12, the use of force is the last force used with either escape or before death of force Tier 1A and 1B are our patrol areas; the policies are the same throughout the prison When we are in Tier 1A and 1B we fall under SSG [REDACTED] we MI needs something done, they talk to me, then I take it to SSG [REDACTED] Sometimes we patrol the halls in teams, or we patrol the halls separately.

When we patrol separately and have to make split decisions, every dog handler has a certain responsibility to comprehend the situation and make the necessary decision. No one tells me how to use my dog when I am in Tier 1A and 1B, I control the area I can't talk about the requests by MI, because it is currently under a CID investigation

I have worked with MI before with interrogation, but I cannot state any specific times or dates I've been told there is a policy besides AR 190-12 governing dog handling, but I've been told it's classified by MI, I don't know which policy it is I haven't seen the policy, I didn't know I had to see anything in writing

I have seen no maltreatment on unsafe acts toward prisoners since I've been here. I use common sense to determine limitations on the employment of my dog I've never had any training or seen anything in writing regarding employment of my dog when working with MI I received a briefing before I came here on the Geneva Convention The Geneva Convention covers legal laws of land and warfare, what to do and what not to do

The treatment of prisoner is covered in AR 190-8 I didn't get too much into how you treat prisoners, when I get called in it is pretty much a last resort, usually a riot or something grotesque is about to happen If someone asks me to execute an unsafe act or perform a violation, it would depend on if I knew the act was a violation, but if it seemed wrong I wouldn't do it If I knew it was violation I would come straight out and tell that NCO or Officer that I'm not going to do it I would report the violation to SSG [REDACTED] and he would take care of it

We have dog handlers out of BIAP who are the kennel masters up here, a new E-6 just took over for SSG [REDACTED] his name is SSG [REDACTED] I've seen my chain of command three times in two and a half months I don't know where they reside, but their number is [REDACTED] I knew they lived in this area, but exactly where I didn't know

The dogs are trained for the mission here Our dogs are narcotic patrol dogs. I keep a utilization log to track when the dogs are used It's hard to do training out here because when we go out in an open field area we get pop shots taken at us, it's more of a

safety/life or death situation I have used empty parts of the jail before to conduct training

We haven't received any support from the unit that is suppose to be taking care of us, that unit is 320th MP Battalion We eventually after a few weeks received most of the things we need after arrival here, but we have been requesting an SUV The reason we need an SUV is as the weather gets hotter, the dogs will not be a to survive the heat riding around in a Humvee For the first five days after we arrived here we had no electricity, after the first week we got electricity, after two weeks we got heat. We have four lights, all of them are broken except one, and one of our air conditions has been down and it is still broken We have submitted request to R&U and 1SG [REDACTED] HHC, 320TH MP Battalion They said that they lost the contract for the air condition and light reparamen, and they are waiting for the new contractors to take over

We are properly staffed to do our required work We are utilized properly. We have other dogs to compliment our mission, we have naval dogs to compliment us. We didn't know that they already had naval dogs working at the compound We originally planned to bring three dogs up but we told the other dog handler he didn't have to come up because the navy already had three dogs at the compound The navy works the ECP because they have explosive dogs SSG [REDACTED] and myself work the compound because our dogs aren't ECP trained

We tried working the compound together with the navy, but it didn't work because or training and policies are too different Even though we train at the same school, the navy babies tends to baby their dogs, as we use our dogs more as equipment. Navy regulation doesn't allow pinch collars on navy dogs whereas the army allows pinch collars as a correction tool for the dog The navy dogs aren't combat trained for missions, they sometimes go out on missions but they shouldn't I think things run fine the way they do with us working the compound and the navy working the ECP The naval dogs are assigned to MI but they work with the MP's

I was advised of my rights on 23 January 2004 I am not sure of the Articles, but CID advised me that I was being charged with, failure to obey a lawful order and cruelty and maltreatment of detainees

I am stationed at Fort Riley, Kansas My unit is 523rd Military Police Detachment I don't have nametags on any of my uniforms because I rather not have the prisoners no my name I know that my uniform is out of regulation

My dog is a Belgium Shepard We were decertified by the program manager that came of a took over for the outgoing program manager I believe in September 2003 Control certification we are good on because we were making our training hours every month, however, being that it's a deployment my certification ended in September 2003. I have been a dog handler almost two years This is my fifth do in almost two years.

My role in regard to detainees was to be a psychological and physical deterrent. I fulfilled that role by patrolling, that patrolling consisted of walking the tiers. My dog was on a short safety when I walked the tier. We normally don't use short safeties outside of the schoolhouse.

The 320th Military Police Battalion is in charge of the hard site. The Battalion Commander is LTC [REDACTED].

The panel stopped, to discuss SGT [REDACTED]'s statements.

The panel called SGT [REDACTED] back in.

The military working dog SOP established the hard site as a patrolling area, to include 1A and 1B. The SOP was put out in December. To the best of my knowledge we did not patrol the hard site prior to December.

I was not trained on AR 190-8, but I seen it laying in our hooch yesterday so I picked it up and looked at it. It belonged to SSG [REDACTED].

No one talked to me about the process of this interview.

CID informed me that I am no longer considered to be a suspect in the charges I stated earlier as of now.

I would rather not discuss how MI at the hard site used us.

We helped MI get their interrogations done. After working at the prison for so long the dogs came not to like the Iraqi detainees. They didn't like the Iraqi culture, smell, sound, skin tone, hair color, or anything about them. So, naturally the dogs became aggressive. It's a learned behavior, a learned behavior from working around the prisoners. If a prisoner is always antagonizing a dog, the dog is going to learn not to like them. The dog notices shapes, different shades of gray, they know when they are being antagonized.

A normal day for me would consist of me letting the NCOIC know that I was here. I would walk the tiers. I would have to get someone to let me in the hard site. I walk the hard site. My dogs never went in the cells. Sometimes if prisoners are outside their cells, I would walk near to them with my dog.

I would recommend that when we walk the tiers that they keep the prisoners out of the way. Also that there be different times set to clean the floors. Seems like every time we patrol 1A and 1B they are cleaning the floors, it is bad for the dog's legs because the chemicals can get absorbed through their feet.

MI would ask me to use my dog as a psychological and physical deterrent. It would consist of a dog walking up to a prisoner and the dog barking at a prisoner. The dogs would bark at prisoners unprovoked.

If I were given an order I would carry it out, depending on the order I wouldn't carry out any order or regulations that would get me in trouble or anyone else in trouble

When I would assist in interrogating a prisoner sometimes the cells would be open, but the dog or myself never went into the cell Sometimes they would pull the detainee out of the cell and depending on the situation I would come within less than two feet of the prisoner I always felt comfortable that I had positive control of the dog

The panel stopped, to discuss SGT [REDACTED]'s statements

The panel called SGT [REDACTED] back in The panel addressed some issues with SGT [REDACTED]

On 13 February 2004, SGT [REDACTED] returned for a follow-up interview

The following persons were present

COL [REDACTED] MP, CFLCC – PMO, Interviewer
CPT [REDACTED], CFLCC – SJA, Interviewer
SFC [REDACTED], U.S. Army MP School, Interviewer
SGT [REDACTED] CFLCC-PMO, Respondent

To questions posed by the panel, SGT [REDACTED] answered, as follows:

I patrol the compounds, go out with QRF (the 82nd) CPT [REDACTED], Sir, makes the SOP. I fall under SFC [REDACTED], and we work for MAJ [REDACTED]. They let us work on our own. There is a DA-6 done, to make sure we are always on a compound. We don't go out a set times. We go out randomly.

Dogs are used at the last level, before deadly force, to prevent escape. I've never had to use my dog in my uses of force. It's not by influence from me, the prisoner antagonizes it. The dog reacts to the prisoners, because, whether you believe me or not, the dog mostly does that on his own, because they are fearful of a trained working dog, and they become animated.

They don't like us to use dogs for crowd control, unless the commander responsible permits it, because dogs can incite riots. They will have working dogs out of site of the crowd, and then if they have to extract somebody from the crowd, then they bring the dogs back, and they will search the person, and the dogs can pull security for them.

A short leash is preferred, if you don't know if the dog is going to break away from you. It's not a type of leash, but a way you carry your leash. Most handlers will have their thumb through the eyelet hole, and over grasp the leash with the right hand. The dog is always on the left, that's a training leash. A short leash is when you take near the clasp, and wrap it around your hand, that way you can control your dog, if it gets agitated. Or, if there are a lot of people around, you can keep your dog by your side. The only time we allow our dogs free reign is when they're taking a break.

I've been in the Army 4 ½ years. I'm stationed at Fort Riley, Kansas, with the 523rd MP Detachment. We have a new Battalion Commander. I don't know who that is. Our Command Sergeant Major is CSM [REDACTED]. I've been here almost 10 months with my dog. Before Abu Gharib, I was a week, at Camp Arifjan, preparing to go to Abu Gharib. Before that, I was at a month at Bucca. Before that I was 2 ½ months at Wolf. And prior to that, I spent the whole time at Camp Arifjan.

We did scouting training. For instance, if a prisoner escapes, which we've had at Abu Gharib and Bucca, we'll scout a field. Building search, if they escape into a building we can also search for that. They are trained in controlled aggression. They're trained to

attack on command, or by any sudden or aggressive movements that a person might make toward our dog, or us or any other person. As far as EPW training, I did not receive any.

My tour has been extended. They're looking at getting us out of here in about 3 weeks.

I remember receiving Geneva Convention training in AIT, but not here. I don't know the classification of the personnel locked up at Abu Gharib. I know that I'm supposed to check in with the NCOIC, when I enter the hard site. I didn't read the part of the SOP, which says I'm supposed to have an escort. CSM [REDACTED] has come through our living area, and he's seen how we live.

I know AR 190-12. I do know how regulate my dog's diet. Military working dogs are fed Science Diet. My dog, specifically, is on Active or Adult Active, whatever we have, Science Diet. A Vet last saw my dog in January. We're required to conduct training with our dogs 4 hours a week patrol training, and 4 hours a week detection training. I don't do detector training. We are not certified as detector dogs. We do get our training, as far as on-leash obedience and off-leash obedience. If we don't get 4 hours in a week, we normally make our 16 hours through the month. I don't maintain a DA Form 2807-R, so I maintain my records in a green notebook.

If a prisoner were escaping, I would release my dog on that person, if he didn't stop, after I commanded him to stop 3 times. Other than that, I would not release my dog, unless there was immediate danger to my life or another soldier's life.

The guards have asked me to walk through the cells, to perform narcotics searches. I informed them that I am de-certified. I've walked through the cells, just to humor them, because, a dog will still recognize an order. 30 days off an odor will de-certify a narcotics dog, or detection dog.

I've never searched a detainee with my dog. Searching personnel with a patrol working dog is not authorized.

I don't believe my dog is certified with DEA. I'm not aware that they are required to be certified with the DEA.

I was a narcotics custodian stateside, but from what I am told, overseas you need a host nation agreement, to actually receive narcotics. I understand that some was ordered, but I have not seen it. I don't remember his name, but there was a Sergeant First Class, who came through and said that all narcotics dogs are no longer certified to do searches.

I can successfully find a prisoner that has escaped, using scout, but not man-tracking, because I don't know how to do that. Since being here, through trial and error, I would like to learn.

Someone from MI gave me a list of cells, for me to go see, and pretty much have my dog bark at them. He said that they were getting good results when we patrolled the prison.

They do react to skin color, hair, and odor, also. He leaves the list at the hard site. He's the tall gentleman that was here yesterday. He has black hair, goatee, and moustache.

My dog has not bitten anyone, since I've been here. SFC [REDACTED] dog has. My dog has never been inside a cell with a prisoner. My dog has never been in a room with an interrogator. Someone has taken a picture of my dog working. I don't know who took the picture. There is a picture on the computer of one of the females, there. It's in the office between 1A and 1B.

I've been asked to search for an escaped prisoner, once. I didn't find him, but I found where he went out. We found his footprints in the mud, in the tower, and sliding tracks on the wall.

We have muzzles. I use them, when we go out with 82nd, or to the Vet. My dogs are aggressive towards gunfire, and I don't want them biting the 82nd guys, who are trying to protect us. I don't regularly use the muzzles inside the compound.

I haven't seen the CJTF-7 policy, regarding the utilization of dogs in conjunction with interrogation procedures.

SFC [REDACTED] presents the policy to SGT [REDACTED] and asks him to read aloud the following:

"Should military working dogs be present, during interrogations, they will be muzzled and under control of the handler at all times, to ensure safety."

I was aware of that. I was briefed by COL Pappas of that. From what I was told, we weren't doing interrogations. Having the dogs bark at detainees was psychologically breaking them down for their interrogation purposes. SFC [REDACTED] dog does the same thing. We were asked. I don't know if we had authority. I didn't have training to do that. I was told that the dog had to be muzzled, if he was in a room with a detainee, and I did clear that with COL Pappas.

From what I was told, weapons are allowed in the hard site. I was told that, when we first went into the hard site. I was last at the hard site on 14 January.

Finished with their questioning, COL [REDACTED] advises SGT [REDACTED] to be mindful of the Creed of the Noncommissioned Officer, and to be mindful of the example he sets for others to follow.

In departing, SGT [REDACTED] states that he had his dog bark at the detainees, at the request of the interrogators, and that this was producing good results.

SGT [REDACTED] was then dismissed.

On 12 February 2004, a team of officers, directed by Major General Antonio Taguba, conducted the following interview. Major General Taguba was appointed as an Investigating Officer under the provisions of Army Regulation 15-6, by Lieutenant General David D. McKiernan, Commanding General of the Coalition Forces Land Component Command (CFLCC), to look into allegations of maltreatment of detainees, detainee escapes and accountability lapses, at Abu Ghraib, also known as the Baghdad Central Confinement Facility (BCCF). The panel also inquired into training, standards, employment, command policies, and internal policies, concerning the detainees held at Abu Ghraib prison. Finally, the panel looked into the command climate and the command and supervisory presence.

The following persons were present:

COL [REDACTED] MP, CFLCC – PMO, Interviewer
LTC [REDACTED] SJA, CFLCC – SJA, Interviewer
LTC [REDACTED] 705th MP Battalion, Interviewer
SGT [REDACTED], CFLCC-PMO, Interviewee
SSG [REDACTED] 27D30, CFLCC – SJA, Recorder

The interview is summarized as follows:

My name is [REDACTED]. My social security number is [REDACTED]. I am a Sergeant. I am currently with the CFLCC Provost Marshall's Office, at Abu Ghraib BCCF. I am Active Duty.

I work at the Abu Ghraib prison. I patrol the facilities, I got outside the wire with the 82nd Airborne and QRF, and I do either house raids or TCP's.

The use of military police dogs is governed by AR 190-12, the utilization of military working dogs, training, general purpose, and requiring of [REDACTED]. The kennel master is SSG [REDACTED]. He is the senior member for army dogs.

The use of force is governed under AR 190-12, the use of force is the last force used with either escape or before death of force. Tier 1A and 1B are our patrol areas, the policies are the same throughout the prison. When we are in Tier 1A and 1B we fall under SSG [REDACTED]. We MI needs something done, they talk to me, then I take it to SSG [REDACTED]. Sometimes we patrol the halls in teams, or we patrol the halls separately.

When we patrol separately and have to make split decisions, every dog handler has a certain responsibility to comprehend the situation and make the necessary decision. No one tells me how to use my dog when I am in Tier 1A and 1B, I control the area. I can't talk about the requests by MI, because it is currently under a CID investigation.

I have worked with MI before with interrogation, but I cannot state any specific times or dates. I've been told there is a policy besides AR 190-12 governing dog handling, but

I've been told it's classified by MI, I don't know which policy it is I haven't seen the policy; I didn't know I had to see anything in writing

I have seen no maltreatment on unsafe acts toward prisoners since I've been here I use common sense to determine limitations on the employment of my dog I've never had any training or seen anything in writing regarding employment of my dog when working with MI I received a briefing before I came here on the Geneva Convention The Geneva Convention covers legal laws of land and warfare, what to do and what not to do

The treatment of prisoner is covered in AR 190-8 I didn't get too much into how you treat prisoners, when I get called in it is pretty much a last resort, usually a riot or something grotesque is about to happen If someone asks me to execute an unsafe act or perform a violation, it would depend on if I knew the act was a violation, but if it seemed wrong I wouldn't do it If I knew it was violation I would come straight out and tell that NCO or Officer that I'm not going to do it I would report the violation to SSG [REDACTED] and he would take care of it

We have dog handlers out of BIAP who are the kennel masters up here, a new E-6 just took over for SSG [REDACTED], his name is SSG [REDACTED] I've seen my chain of command three times in two and a half months I don't know where they reside, but their number is [REDACTED] I knew they lived in this area. but exactly where I didn't know

The dogs are trained for the mission here Our dogs are narcotic patrol dogs I keep a utilization log to track when the dogs are used It's hard to do training out here because when we go out in an open field area we get pop shots taken at us, it's more of a safety/life or death situation I have used empty parts of the jail before to conduct training.

We haven't received any support from the unit that is suppose to be taking care of us, that unit is 320th MP Battalion We eventually after a few weeks received most of the things we need after arrival here, but we have been requesting an SUV The reason we need an SUV is as the weather gets hotter, the dogs will not be a to survive the heat riding around in a Humvee For the first five days after we arrived here we had no electricity, after the first week we got electricity, after two weeks we got heat We have four lights, all of them are broken except one, and one of our air conditions has been down and it is still broken We have submitted request to R&U and 1SG [REDACTED] of HHC, 320TH MP Battalion They said that they lost the contract for the air condition and light repairmen, and they are waiting for the new contractors to take over

We are properly staffed to do our required work We are utilized properly We have other dogs to compliment our mission. we have naval dogs to compliment us We didn't know that they already had naval dogs working at the compound We originally planned to bring three dogs up but we told the other dog handler he didn't have to come up because the navy already had three dogs at the compound The navy works the ECP because they have explosive dogs SSG [REDACTED] and myself work the compound because our dogs aren't ECP trained

We tried working the compound together with the navy, but it didn't work because our training and policies are too different. Even though we train at the same school, the navy babies tend to baby their dogs, as we use our dogs more as equipment. Navy regulation doesn't allow pinch collars on navy dogs whereas the army allows pinch collars as a correction tool for the dog. The navy dogs aren't combat trained for missions, they sometimes go out on missions but they shouldn't. I think things run fine the way they do with us working the compound and the navy working the ECP. The naval dogs are assigned to MI but they work with the MP's.

I was advised of my rights on 23 January 2004. I am not sure of the Articles, but CID advised me that I was being charged with, failure to obey a lawful order and cruelty and maltreatment of detainees.

I am stationed at Fort Riley, Kansas. My unit is 523rd Military Police Detachment. I don't have nametags on any of my uniforms because I rather not have the prisoners know my name. I know that my uniform is out of regulation.

My dog is a Belgium Shepard. We were decertified by the program manager that came of a took over for the outgoing program manager I believe in September 2003. Control certification we are good on because we were making our training hours every month, however, being that it's a deployment my certification ended in September 2003. I have been a dog handler almost two years. This is my fifth dog in almost two years.

My role in regard to detainees was to be a psychological and physical deterrent. I fulfilled that role by patrolling, that patrolling consisted of walking the tiers. My dog was on a short safety when I walked the tier. We normally don't use short safeties outside of the schoolhouse.

The 320th Military Police Battalion is in charge of the hard site. The Battalion Commander is LTC [REDACTED].

The panel stopped, to discuss SGT [REDACTED]'s statements.

The panel called SGT [REDACTED] back in.

The military working dog SOP established the hard site as a patrolling area, to include 1A and 1B. The SOP was put out in December. To the best of my knowledge we did not patrol the hard site prior to December.

I was not trained on AR 190-8, but I seen it laying in our hooch yesterday so I picked it up and looked at it. It belonged to SSG [REDACTED].

No one talked to me about the process of this interview.

CID informed me that I am no longer considered to be a suspect in the charges I stated earlier as of now

I would rather not discuss how MI at the hard site used us

We helped MI get their interrogations done After working at the prison for so long the dogs came not to like the Iraqi detainees They didn't like the Iraqi culture, smell, sound, skin tone, hair color, or anything about them So, naturally the dogs became aggressive It's a learned behavior, a learned behavior from working around the prisoners If a prisoner is always antagonizing a dog, the dog is going to learn not to like them The dog notices shapes, different shades of gray, they know when they are being antagonized

A normal day for me would consist of me letting the NCOIC know that I was here I would walk the tiers I would have to get someone to let me in the hard site I walk the hard site My dogs never went in the cells Sometimes if prisoners are outside their cells, I would walk near to them with my dog

I would recommend that when we walk the tiers that they keep the prisoners out of the way Also that their be different times set to clean the floors Seems like every time we patrol 1A and 1B they are cleaning the floors, it is bad for the dog's legs because the chemicals can get absorbed through their feet

MI would ask me to use my dog as a psychological and physical deterrent It would consist of a dog walking up to a prisoner and the dog barking at a prisoner The dogs would bark at prisoners unprovoked

If I were given an order I would carry it out, depending on the order I wouldn't carry out any order or regulations that would get me in trouble or anyone else in trouble

When I would assist in interrogating a prisoner sometimes the cells would be open, but the dog or myself never went into the cell Sometimes they would pull the detainee out of the cell and depending on the situation I would come within less than two feet of the prisoner I always felt comfortable that I had positive control of the dog

The panel stopped, to discuss [REDACTED]'s statements

The panel called [REDACTED] back in The panel addressed some issues with [REDACTED]

On 11 February 2004, a team of officers, directed by Major General Antonio Taguba, conducted the following interview. Major General Taguba was appointed as an Investigating Officer under the provisions of Army Regulation 15-6, by Lieutenant General David D. McKiernan, Commanding General of the Coalition Forces Land Component Command (CFLCC), to look into allegations of maltreatment of detainees, detainee escapes and accountability lapses, at Abu Ghraib, also known as the Baghdad Central Confinement Facility (BCCF). The panel also inquired into training, standards, employment, command policies, and internal policies, concerning the detainees held at Abu Gharib prison. Finally, the panel looked into the command climate and the command and supervisory presence.

The following persons were present:

MG Antonio M. Taguba [REDACTED], DCG-CFLCC, Interviewer
COL [REDACTED] MP, CFLCC – PMO, Interviewer
LTC [REDACTED] JA, CFLCC – SJA, Interviewer
LTC [REDACTED], 705th MP Battalion, Interviewer
MAJ [REDACTED], NAS Signal and Canine Unit, U.S. Navy,
Interviewee
SSG [REDACTED], Jr., [REDACTED] 27D30, CFLCC – SJA, Recorder

The interview is summarized as follows:

My name is MAJ [REDACTED]. I am in the U.S. Navy. My social security number is [REDACTED]. I am assigned to the NAS Signal and Canine Unit. I can be addressed as Petty Officer or MAJ.

I received a verbal order from my Chief back at NAS signal saying that there was a mission coming up at that I may receive it. Time passed and I was told that I would be the one to take the mission here. I am a dog handler. I came here with two other individuals from the same region, but different basis. We arrived here on 18 November 2003. We were given no specific instructions before our arrival here. We reported to the 320th TOC when we arrived, prior to coming to the prison we met with MAJ [REDACTED] and he told us he was the POC.

As far as I knew we were to support the prison with canine support. I had never worked in a prison environment before. We did a one-day training period on scout and search for escape prisoners back at my unit. No one wanted to claim us when we arrived here so the 229th Military Police Company picked us up. It was just us navy dog handlers that got picked up by the 229th MP CO, the army dog handlers arrived a day or two later. We had a total of five dogs here. There were three navy dogs and two army dogs.

We usually worked with the Internal Reactionary Force (IRF). We would go out with the IRF when they received a call from the 320th TOC. I believe CPT Jones to be the commander of the 299th MP Company. We never received any orientation on what was

expected out of our canine unit, we just used common sense. I am the NCOIC for the navy dog handlers, and SSG Cordona is the NCOIC for the army dog handlers.

We usually stayed in close contact with CPT [REDACTED] and MAJ [REDACTED]. Upon arrival we began working with the IRF on a daily basis, then about a week later we took over the Entry Control Point East (ECP) for vehicle searches as well as working with the earth. I went over a work schedule with CPT [REDACTED] regarding a rotation for covering the ECP and the IRF. We had one dog at the ECP, and the other two on standby with the IRF.

We never received any instruction on the use of force in the compound. We raised question on what we could and could not do in this environment, but we never received a straight answer. I briefed my team to use common sense, and use your escalation of use of force as the situation dictates. Based on the escalation of use of force, a dog cannot be employed on a prisoner if that prisoner is not posing a threat.

I have a Belgium Melon. He is a control explosive dog. My dog had never been in a prison environment. The dogs didn't have to be retrained we used the same commands.

On the night of 24 NOV 03 we were with the IRF when we received a call to search the hard site for explosives. We had heard also that a prisoner had someone had been shot. All 5 dogs were there that night. The army dogs were for security while our dogs searched for explosives. We went to specific Tier, I couldn't tell you the name, but I could show you if I were in the facility. We searched the cells for explosives, none of the dogs responded. We were preparing to leave when we were told we needed to search another cell. I decided to conduct the search. I reentered the Tier and saw two individuals who were dressed in green BDU's. They instructed me to search the cell and as I approached the cell I heard a lot of shouting and screaming. I looked around and noticed that there was no one else up there, that no other cells were occupied.

I peaked my head in the cell and noticed four individuals, three males and one female. One male was in the corner, two males were crouching, and the female was next to the rack. I was having a hard time controlling my dog because of the noise, and the actions that were happening. I finally got my dog under control when one of the MI guys told one of the detainees, "If you don't tell me what I want to know I'm gonna get this dog on you". or words to that effect. I realized that it wasn't a search and they actually wanted my services for interrogation. I exited the cell, but my dog would break the plan of the cell. The two individuals and the female, which I know now to be an interpreter, reentered the cell and went back in a started yelling and screaming at this guy again.

With all the yelling and screaming going on my dog breaks my control and charges the cell. The cell was very dark, the only illumination was a pin light. I see the female wincing, and I notice my dog on her arm. I immediately call my dog off of her, and my dog comes back to the heel. I ask the female to come out so I can check her. She comes out of the cell and I constantly ask her, "Are you alright, did he bite you?" She says she is ok and that she wasn't bit. I looked at her arm no bite mark, no blood, and her DCU uniform wasn't torn. I once again ask her if she is ok, and does she need medical.

attention. At that point I see SGT [REDACTED], and I ask what's going on, and he responded by saying he didn't know. Once I realized what was going on I left, I didn't want any part of what was going on. As I was leaving, SGT [REDACTED] followed and then I heard someone say, "where's the dog, where's the dog?"

No names were said but I know one of the individuals was about 6'4", short black hair, slender build, brown eyes, wearing civilian clothes. The interpreter was about 5'7", medium black hair, and I believe she wore glasses. I couldn't tell you what the other two looked like.

When I arrived at the cell I let the personnel know I was there for the search. I never had a discussion with the MI about my dog being used in interrogation. It was a male's voice asking where the dog was. The other navy handler's were called and they actually refused the call because of my incident. They were called once more and then again they refused.

When a search is conducted the detainee should be removed, leave everything in the same condition, give the command for the dog to search the room, let the dog search the room, and then exit the room. On 24 NOV 2003 we were called to the compound to conduct the explosive search. I have never been called to Camp Ganci or Camp Vigilance without the IRF. We keep paperwork on the dogs; the form is a 5585/3-detection/utilization form. We turn in a copy each month. I don't have a record for the incident on 24 NOV 2003, because we only keep track of active searches.

We were never instructed on the Geneva Hague Convention, I just try to treat people with respect. There has been occasions where we have let the IRF commander, 1LT [REDACTED] know we have refused to go to the compound. We were never told not to comply with MI and MP's when they request us to assist them. We never received any guidance on what was authorized and not authorized. The interrogators never approached us individually about us assisting them at the compound. I don't know if the Army dog handlers were ever approached.

SSG [REDACTED] set up a wall between the Army dog handlers and us. SSG [REDACTED] stated that the Navy was basically dipping into his Kool-Aid. I sit down with SSG [REDACTED] to try to work as one team, but SSG [REDACTED] didn't want to work as a team. We work for the IRF commander, and the Army dogs work for the compound.

I have heard rumors that there are videotapes and pictures of detainee abuse, and I heard there was a videotape of a rape. We have a SOP that was written up by CPT [REDACTED] and containing input and guidance from myself. The SOP basically states that the navy handlers are not to be used for anything except for what we were trained for.

SSG [REDACTED] and myself shared lessons learned. If anything came up on a professional level we would share it with each other. I honestly believe that dogs are under utilized here, I don't think there is a need for dogs here other than the ECP and for any escape attempts.

We once went out with the 82nd on a mission outside of the compound. We provided security for their team, and also searched fields for weapon caches. I recommended that there be only one canine unit team assigned to this compound.

The SOP that CPT [REDACTED] and myself worked on was finished in December. I know CPT [REDACTED] tried making the Army Handlers follow the SOP and I personally gave SSG [REDACTED] two copies of the SOP, but like I said before SSG [REDACTED] didn't want to be part of a team.

I received my dog handling training at the 341st Training Squadron, Lackland Air Force Base, San Antonio, TX. My next assignment was with Southwest Regional Canine Unit, San Diego, CA.

The panel stopped, to discuss MAJ [REDACTED] statements.

The panel reconvened.

There were two male personnel dressed in civilian clothes inside the cell that I assumed to be MI. There were two personnel dressed in BDU's were outside across from the cell.

The Tier had lights on but the cell was dark.

That was my first time in the hard site.

I was outside the hard site when I received the call about a dog being needed. I assumed when the call was placed for a dog, that I was needed to conduct a search. I realized once the interrogator threatened the detainee with the dog, that it was not for a search.

When my dog lounged, I came forward about three or four seconds and regained control of my dog and pulled him back. My dog's leash is about six feet, it did not extend all the way. They started back yelling and screaming and that is when I lost control of my dog again. My leash extended almost all of the six feet. I couldn't tell the detainees reaction because it was so dark, at that time I was trying to regain control of my dog.

We would train with the IRF from time-to-time. We would rehearse in an open area near the compound. When we got called out for a search, the compound supervisor would let us know it was clear to enter. Next the IRF takes a line formation in front of the "pen". Once the line is set we take someone from the IRF and we start to search the tents, as they hold the line. Once we done searching the tents we position ourselves behind the line. When we search the cells, it's just the dog handler and the dog.

5585 2 B is the Navy military working dog manual. I haven't seen or reviewed any Army Manuals regarding military dogs.

Finished with their discussion, the panel briefed MA1 [REDACTED] and then they dismissed him

1 [REDACTED] civilian, was interviewed on 12 February
2 2004, as follows:]

3 Q Has anybody informed you as to the nature of your
4 presence here with us this morning?

5 A No

6 Q I'm amazed. Okay, so you were basically told to just
7 show up?

8 A It's the extension of a 15-6 and I'm not Army, so I'm
9 not familiar with the extent of what a 15-6 is.

10 Q That's fair. Let me go ahead then and inform you of
the nature of this interview. I'm Major General Taguba, the
12 Deputy Commanding General of the Coalition Land Forces Component
13 Command, headquartered at Camp Doha, Kuwait. My Commanding
14 General, Lieutenant General David McKiernan, appointed me as the
15 investigating officer under the provisions of Army Regulation
16 15-6, which gives us the authority to conduct the investigation,
17 and also the direction of General John Abizaid, the Commander of
18 CENTCOM, Central Command. This investigation is to gather all
19 relevant facts and circumstances surrounding the recent
20 allegations of maltreatment of detainees at the Abu Ghurayb,
21 also known as the Baghdad Central Confinement Facility, as well
22 as detainee escapes and accountability lapses as reported to
23 CJTF-7. Now, we were also directed to investigate the training

1 standards, employment, command policies and internal policies
2 concerning the detainees held at Abu Ghurayb Prison. And we're
3 also to assess the command climate and the supervisory presence
4 of the 800th Military Police Brigade Chain of command.

5 I also want to advise you that the course of our
6 interview will be recorded so we can capture the accuracy of the
7 questions and the responses for the record. So, do you have any
8 questions before we continue?

9 A [Negative response.]

10 Q Sir, for the record, would you please state your full
11 name, your social security number, your job position and of
12 course your unit of assignment.

13 A Sure My name is [REDACTED]
14 [REDACTED] I am [REDACTED],
15 as well an interrogator, who is employed by CJTF-7, to support
16 operations, KMI operations throughout theater, specifically, Abu
17 Ghurayb

18 Q Thank you When were you assigned to conduct your
19 present duty assignment?

20 A I arrived in country, in Iraq, on 5 October 2003, and
21 on 5 October, we arrived at the prison, as well

1 Q Prior to that, were you informed of the--I would
2 assume, back in the United States, as to the nature of your duty
3 assignment?

4 A To the extent of....

5 Q What you were going to be----

6 A Yes, I was informed that I was going to be an
7 interrogator, possibly at Abu Ghurayb or other facilities in
8 country

9 Q What was your job position back in the United States
10 prior to being informed that you were coming to Iraq?

11 A For 6 months, I was off, roughly 6 months, prior to
12 that, I was off. And prior to that, I was mobilized from
13 November 01 until March of '03

14 Q Doing what?

15 A I'm a Navy intelligence specialist. I was working
16 with DIA, Defense Attache System

17 Q But you're no longer associated with the Navy, or are
18 you still on----

19 A I'm on Inactive Ready Reserve status, so I could come
20 out here on this deployment

21 Q Was your background pretty much on Navy intelligence,
22 HUMINT?

1 A My last, basically 2 years, have been involved on the
2 HUMINT side. And prior to that, between intel analyst, as well
3 as imagery.

4 Q Now, did you have a previous assignment that's
5 coincidental, even relative to what you're conducting today,
6 like a GTMO or Bagram or anyplace else?

7 A You mean interrogation assignment?

8 Q Yes.

9 A In a military setting, no, but my commercial training,
10 if that's what you're alluding to, has come from what I've done,
11 International Recruitment, similar training from my DIA
12 counterpart, I was a case officer, running sources, do business
13 development is the same thing as dividing and gathering your
14 networks, interviewing your possible staff that you might hire
15 or hire for other companies. It's the same hiring and
16 questioning process that you would through, an interrogation,
17 questioning or screening series

18 Q Training, that sort of thing?

19 A Yes.

20 Q Did you have any experience whatsoever being directly
21 involved with interrogation of a detainee?

22 A When I was operational, or provided operations and
23 supervision support out of the USDA [inaudible].

1 Q So you're out here on the 5th of October, on or about,
2 there about, and you were directly assigned to the Abu Ghurayb
3 confinement facility.

4 A Yes

5 Q Who was your supervisor at that time, if you recall?

6 A Within the JDIC Ice operations?

7 Q Sure

8 A The...who was the NCOIC.. I can't recall the NCOIC's
9 name They were part of the--when we were arriving, there was a
10 turnover there. So he was only there for about a week. From
11 that point, Chief [REDACTED] was the secondary OIC, and
12 then Captain Carolyn [REDACTED] was the OIC

13 Q Now, the JDIC did not exist at that time, or did it
14 exist when you arrived?

15 A From my understanding, it did exist.

16 Q All right, to your understanding. Did you receive any
17 in-briefs or set of instructions on the operating environment
18 and what the nature of the, specific nature of your duties would
19 be?

20 A Yes, sir

21 Q Who gave you that instruction?

22 A Captain [REDACTED]

1 Q Captain [REDACTED] did? Did that set of instructions
2 include any familiarity at all or refresher training on the
3 Geneva Convention?

4 A No.

5 Q No? Did you, since you were in that particular set of
6 experiences previously as a Naval officer in the Reserves, in
7 the context of other training that you conducted prior to your
8 assignment here, did you have any knowledge whatsoever or
9 training, interaction with detainees or through interrogative
10 means or detention include some knowledge or familiarity with
11 the Geneva Convention?

12 A Yes, I have. In fact, I read up on that on my own, as
13 well as provided the--recently, I've used them again to refresh
14 and provide guidance for a friend of mine.

15 Q But when you arrived here, there was nothing...

16 A There was nothing formal in place pertaining to the
17 Geneva Convention, that's correct.

18 Q But you were informed or at least had knowledge of the
19 contents of the provisions of .

20 A Yeah.

21 Q Did you have any assumption at all or any knowledge
22 that you, being a civilian contractor, also could be held liable

1 for any violations that might be consistent with the Geneva
2 Convention?

3 A. Absolutely. That was one of the first questions prior
4 to my arrival. And once I did arrive in country within our
5 organization, as well as within the military setting what
6 statutes the civilians fall under versus military members, which
7 are punishable by the UCMJ. Civilians are punishable, from my
8 understanding, under the Federal court system.

9 Q Did you inquire as to what your status would be while
10 you're in a combat operating area, that your status, if you were
11 ever captured by anti-coalition forces, did you inquire into the
12 nature of what your status will be if you were captured or
13 detained?

14 A From my understanding, since we are contracted, I just
15 assumed, because on my CAC card, it says we're covered under the
16 Geneva Conventions.

17 Q But nothing beyond that.

18 A No.

19 Q So in a case where you may be held or detained or
20 killed or wounded in a combat area, it was never stipulated to
21 you in any clear terms?

22 A No, not at all.

1 Q Okay, all right. Let me move forward You've been
2 there since the 5th of October.

3 A. Yes

4 Q And conducting interrogations or whatever you're being
5 directed to do, I'm not asking you--let me preface this, not
6 asking you the contents of any interrogation, but could you
7 elaborate a little bit on the typical operation of an
8 interrogation? I mean, when do you--is there a plan of sorts
9 that you discuss previously with a translator? Is there a plan
10 of sorts that you discuss with anybody from the MPs that are
' holding the detainee, time, that sort of thing?

12 A All the interrogators are assigned to teams, Alpha
13 through Charlie, through Echo We're given--we'll just start
14 with a new case file

15 Q Sure

16 A Find the assessment, let's see where the detained has
17 derived from, what the circumstances of capture are. As the
18 interrogator, you sit down with your analyst. You go through,
19 find out as much information about the detainee as possible, the
20 capturing unit, check with the magistrate's office, review what
21 they have on file, collect whatever you need from to put in your
22 file to build up the foundation At that point in time, you
23 schedule with your section chief as to the time of

1 interrogation. In most of the cases I work in, I usually have
2 an analyst there with me, so I brief the analyst prior to going
3 into the interrogation. To what depth and what extent, that
4 will vary with what the interpreter will receive. And also,
5 it's a matter of comfort and level of trust with the
6 interpreter, as well. Some, we use specifically as just--if you
7 want an umbilical cord of the interrogator. Others can become
8 more in depth who are assigned to more of your high value
9 targets who will become more actively involved and read up on
10 reports, etceteras

1 Q Basically, do you typically work with the same
12 interpreter, or do you change around based on the nature of----

13 A Recently, I've worked with the same interpreter due to
14 the significance of the case and the level of his expertise
15 But prior to that, I had used a reasonable amount of the
16 interpreters.

17 Q Is there an established or a set schedule, written or
18 otherwise, that says, "These are the detainees I want to
19 interview today?"

20 A Depending on your case load, you work with your
21 section chief and you're organizing your schedule throughout the
22 time period

1 Q Let me be a little bit more specific. The detainees
2 that are held at Tier 1 A, they're held there for a specific
3 purpose that you're familiar with. In your interaction with the
4 MPs that are holding, or at least a company or a unit that is
5 holding that particular detainee, when you have a set schedule,
6 is that schedule articulated to them verbally or is it
7 articulated to them in a written form?

8 A It's not articulated to them at all.

9 Q So how does that happen?

10 A In terms--you do your prep and planning. Depending on
11 the reaction and the information received or not received from
12 the previous interrogation is how you'll schedule and time your
13 next interrogation. In some cases, it could be late at night
14 due to the fact that the detainee is less alert and is apt to
15 get more information because all they want to do is go back to
16 bed

17 Q Sure.

18 A Versus a midday one when they're nice and relaxed and
19 had a good night's sleep. They're more responsive and are able
20 to countermeasure us and etceteras. So, in terms of putting
21 those efforts, they're done within the operations section. I'm
22 not outside with the MPs

1 Q And is that an established or a standard operating
2 procedure that's provided and approved by----

3 A. That has been the operating procedure that's been
4 presented to us upon my arrival and I've assumed to be the norm
5 since then

6 Q. And that was briefed to you by whom?

7 A It wasn't briefed, that's just what was.

8 Q What was, so that was your understanding. Was that in
9 a written form or common practice?

10 A. Common practice, nothing written.

11 Q. Nothing written; so that was basically left to your
12 approach or a common approach within----

13 A As well as the coordination with your section chief.

14 Q So that was an approved process. So there's no
15 question in your mind that that was the approved process?

16 A For setting a time period for coordinating
17 interrogations in isolation--or segregation, as it's referred to
18 now

19 Q. Sure

20 A [Affirmative response.]

21 Q Was there ever a requirement in the unit or the
22 battalion that you belonged to, that you were associated with,
23 which is I believe at that time, the 165th MI Battalion.

1 A Prior to that, it was the 519th.

2 Q Was it the 519th MI Detachment?

3 A Right.

4 Q Was there a requirement to put an interrogation plan
5 in writing?

6 A Yes, you have to have a double-sided interrogation
7 plan, what your approach is, whether or not the detainee's
8 information has been researched, whether it needs national
9 agency check and background check etceteras, exploitation, any
10 type of requirements that are outstanding for collection against
11 HCRs, things along that nature Then you turn it over and you
12 write out an interrogation plan The one currently being used
13 now is an evolutionist one that was being used previously. So
14 it's been an ongoing living document That's how they've been
15 documenting the process

16 Q Who approved that plan?

17 A Section chief reviews it Then it goes to either the
18 NCOIC or the OIC

19 Q What governs that interrogation plan?

20 A The rules of engagement

21 Q The rules of engagement How long has that rules of
22 engagement been published?

23 A As far as I know, since the time I've arrived.

1 Q It's been posted?

2 A Yes

3 Q Do you recall that being briefed to you when you first
4 arrived?

5 A We were given a--everybody, from a Khaki perspective,
6 and any people we bring in on board are given the rules of
7 engagement brief. We have to sign that. Now, we've signed
8 multiple variations since we've arrived, but everybody has had
9 to read them and re-sign them

10 Q Does that interrogation plan look anything--I'm sorry,
11 rules of engagement, look something similar to that [while
12 showing document to Mr ██████████

13 A This is the copy that was posted in the ISO.

14 Q Okay It was posted in October when you first
15 arrived?

16 A No, this was posted--I'm not quite sure when they
17 posted it They've had an 8 1/2 by 11 piece of paper up on a
18 bulletin board And then recently, I think it was in December,
19 I can't remember the actual time, it was early December, end of
20 February--November, when you go out through the doorway, there's
21 a bunch of pieces of..

22 Q This particular interrogation rules of engagement was
23 posted, I believe, after Colonel Tom Pappas assumed command of

1 the Forward Operating Base Abu Ghurayb. And this particular
2 interrogation rules of engagement was approved by General
3 Sanchez because of differing and inconsistent practices done
4 during interrogation. Was that explained to you?

5 A No.

6 Q So you just took it at face value that this was
7 revised due to other things that had occurred. Have you had any
8 knowledge of interrogators being disciplined for going beyond
9 the bounds of their authority?

10 A Just recently.

11 Q Which one was that?

12 A Just seen members, I'm not sure from where--I was told
13 right when we arrived, there was an incident in the segregation
14 section where a soldier was----

15 Q Segregation in the hard site?

16 A Yeah, alpha section. It used to be isolation, but now
17 the new term is "segregation," the hard site. And they came in
18 for their final, I guess, I wasn't sure if it's Article 15 or
19 what the procedure was, and people I had seen when I first
20 arrived were coming back in and reintroducing. . .

21 Q Based on those infractions, do you recall the
22 Battalion Commander, Detachment Commander, the Brigade Commander

1 gathering all the interrogators and amplifying any kind of
2 corrective actions to be taken?

3 A You mean right after this----

4 Q Right.

5 A I mean, nothing strikes the mind. We've had recent
6 refreshers on rules of engagement. But citing, "Hey, this, X, Y
7 and Z happened. Do not do this. Do not repeat the behaviors,"
8 are lessons learned from it? No

9 Q So you don't recall any of that. Moving a little
10 faster here. You made a statement that was dated the 22d of
11 January of the events or the 20th of December. It was you,
12 Sergeant Eckron, you also mentioned John Israel in there, of
13 remanding or returning a prisoner back to the custody of the
14 MPs I believe you mentioned Sergeant [REDACTED] and Staff
15 Sergeant [REDACTED] if I'm not mistaken. Can you describe for us
16 the events, what was going on?

17 A After conducting our interrogation that evening, which
18 at that point in time, common practice was, we were afforded the
19 option to interrogate in the upstairs shower facilities or a
20 rear stairwell down in the far left corner of the isolation,
21 Alpha wing. When we had concluded our interrogation, we had
22 handed off the detainee to the MPs who came back to the
23 stairwell to receive the detainee. We proceeded forward. The

1 MP and the detainee were behind us, handcuffed, restrained,
2 walked him back to what we call the hole, which is a complete
3 segregative cell, no walls, there's no wires. The MPs placed
4 the detainee in the room. As we were getting ready to walk up
5 the steps, heard suspicious sounds. They were suspicious. I
6 didn't see anything. We heard something suspicious enough that
7 we confronted the MPs.

8 Q What kind of sounds? Yelling? Choking?

9 A Not a yelling, not a choking sound, an "Umph." You
10 know, say if--the only way I can equate it to is if you're--and
11 you're getting in you're getting in a fist fight and somebody
12 hits you in the stomach, and "Umph," and they knock the wind out
13 of you.

14 Q Now, the MPs would not have weapons on them at any
15 time, a baton or firearms or anything that you observed?

16 A Batons, no, I've never seen an MP with a baton in that
17 wing at all. The MPs, it was common practice for an MP to carry
18 a weapon. They would have weapons in there in their staging
19 area.

20 Q Although firearms are not included [inaudible] SOP on
21 allowing firearms in there while they're handling a detainee,
22 but there are other items that could be construed as a weapon.

3 A Yes.

1 Q A knife....

2 A. Everybody--my rules are, meaning MI, no knives, no
3 Gerbers, nothing.

4 Q None of that

5 A So we are sanitized And that's strictly enforced on
6 a regular basis Everybody's checked. I've gotten to the point
7 I don't even carry a Gerber anymore because it's not worth the
8 problem of taking it on and off throughout the day. So if they
9 were wearing one, you actually couldn't see if they were or not.
10 At the finish, when we had walked, went upstairs and we signed
11 the detainee in the log, from that point, when the MPs were
12 standing around waiting for them to come back up, we confronted
13 them, "What was that all about?" They weren't happy or
14 comfortable with the fact that we questioned them on that. Once
15 that was done, we presented that to them, we went back into the
16 operations area. I spoke directly to Chief [REDACTED] and
17 then we also----

18 Q [REDACTED] was your ICE there?

19 A Yes, he was the OIC at the time Captain [REDACTED] was
20 gone She has been redeployed Chief [REDACTED] was the OIC for
21 the evening, and presented it to him, as well as we went with
22 that to Chief [REDACTED] who was in operations, and we presented it
23 to both of them

-

1 Q That was a verbal report to them.

2 A Yes

3 Q Do you have any knowledge, whatsoever, of the use of
4 dogs in interrogation or in the detainees' cells?

5 A In the detainees--for interrogation purposes?

6 Q Right, to intimidate the detainee or other than for
7 what the purpose is to search?

8 A I know, just the searching aspect, I have not used
9 them as part of--using dogs to intimidate----

10 Q Not you, per se, but rumors or anything of that sort,
11 but the use of military working dogs----

12 A The only thing I've been a part of is walking down and
13 seeing the dogs doing the searches and in that capacity.

14 Q Did you physically observe that, or did you just have
15 knowledge of it?

16 A Had knowledge of it and one instance where I did
17 observe, was in one of my written statements, which I indicated
18 when I came down, my detainee was on three sessions of a managed
19 program. So given that, he was then under medical supervision,
20 trying to determine if the doc was in yet for the psychological
21 supervision. It was right around the time when then the
22 psychologist came on board. So we had been monitoring all the
23 different facets, mental, physical well-being. And he had

1 problems with his feet swelling up, so I went down to check on
2 him, check his condition. And at that instance is when they
3 were doing the cell checks, the detainee was not in his cell.
4 The detainee was still in the hole at that point. He was in
5 between the sleep management program in which he was put into
6 his isolation cell, or I should say, in the hole. And from
7 there, the MPs were going to check him, the hole, and that's
8 where I seen the dogs. They were barking at him; they went in
9 and checked his area. The dog continued to bark. And given a
10 normal operating environment, seeing--since he was my detainee,
11 I did go ask the detainee two or three questions pertaining
12 particularly to the operation as to why we were checking the
13 detainee. And from that point, walked out, the MPs, the dog was
14 still working, barking and going through. So I don't know--I've
15 never gone through and seen what they do when they search his
16 cell and what have not. And once that pretty much finished, sit
17 around and watch for a little while longer, and then I went up
18 to my area.

19 Q Just for clarification, where in that hole then, the
20 detainee was in his cell with the dogs in his cell?

21 A The only time that the detainee was in the hole with
22 the dog was for about a brief 8 to 10 seconds. The detainee was

1 on the back side of the wall. The dog was being held on a short
2 leash.

3 Q But then, in other words, you assumed or at least were
4 informed that a search was being conducted?

5 A Yes.

6 Q Did you know that when they do a search of a
7 particular cell or particular area that the detainee is not
8 supposed to be in his cell with the dog present?

9 A That I did not know.

10 Q Because that could be construed as using a military
11 dog as part of the search, or could be construed as part of the
12 interrogation process.

13 The night there was some shooting incidents in there,
14 riots that you may have known about or have direct or indirect
15 knowledge about, were you asked to at least participate or react
16 to that particular shooting incident that happened on or about
17 the 24th of November?

18 A I was down there for a brief time, a short time span.
19 The night of the shooting, I wasn't there for the shooting. I
20 was working in the JDIC, the ICE. They called the majority of
21 the interrogators down, with "they," meaning the command, that
22 was Colonel [REDACTED] and Chief [REDACTED]. They requested a large
23 number of interrogators to go down because they just did a

1 shakedown of the Iraqi police and they were suspected of
2 arresting seven, eight Saddam Fedayeen members, and they were
3 doing on-the-spot interrogations in the passageway that leads
4 down toward the segregation section.

5 Q. There is a gate there that separates the rest of the
6 hard site, I believe, with the tier. Was the inspection being
7 done there?

8 A. Yes, from that section all the way up to the--you come
9 in from the Alpha, Bravo section, that tier, from where that
10 gate is up until the Iraqi police, first tier there.

11 Q. So they mobilized all the interrogators. Were you
12 inside Tier 1?

13 A. No.

14 Q. Not at all.

15 A. The only time I went in was, shoot, I don't know if it
16 was the next day or that night, because I wanted to see where
17 the shooting was.

18 Q. Sure.

19 A. That's also a detainee that I had been working on from
20 the time in which he was brought in.

21 Q. The guy who got shot.

22 A. Yes. And actually, I was supposed to go in and
23 interrogate that night with that person.

1 Q But somebody else interrogated him

2 A No, not from my understanding

3 Q Comments were made by MPs that there were two civilian

4 interrogators who were inside his cell, that one was a female

5 translator, along with a military working dog detachment. Were

6 you aware of that?

7 A No, I'm not

8 Q Were you ever informed that that existed during that

9 period of time?

10 A [Negative response.]

11 Q Were you aware that Colonel ██████████ was there at the

12 time, as well?

13 A For that interrogation? No

14 Q Let me go back to locations of interrogations. Where

15 are the authorized sites for interrogations normally conducted?

16 A As of today?

17 Q As of then?

18 A As of then? I believe we had the steel site, which

19 was located right outside Camp Vigilant, the wood site, which is

20 behind the isolation--segregation section. And then three

21 locations within segregation, itself, two showers on the upper

22 floors, and then the stairwell in the back corner of the first

23 floor

1 Q Those sites are outside, those are separate and
2 distinct from the cell area, themselves.

3 A Well, separate in what way? Separate in they're not--
4 --

5 Q. Separate from the immediate location----

6 A Yeah, separate from the cell, itself, yes.

7 Q Is it common practice or a practice as far as a matter
8 of expediency to do any kind of interrogation immediately in
9 their cell?

10 A From my understanding--oh, actually, yeah, that's the
11 other one. It's been common practice to go in and question a
12 detainee in his cell, yes.

13 Q In his cell

14 A Yeah

15 Q Typically, who is present in the cell?

16 A Your interpreter, interrogator, analyst.

17 Q That's a standard operating procedure in the absence
18 of other guidance? Well, let me rephrase that. Those times
19 when they were being interrogated, the detainees were being
20 interrogated in those sites you just described, I believe the
21 facility at Abu Ghurayb just experienced mortar shelling. And
22 those that I interviewed, was the reason why those sites were

1 being used, utilized for interrogation was both to protect the
2 interrogators, and this is for safety requirements.

3 A Right.

4 Q But let me understand then, but is it an approved,
5 established procedure in your experience as an interrogator that
6 interrogations are done in the cells, themselves. There's no
7 prohibition, whatsoever----

8 A No, it wasn't prohibited. It wasn't in writing
9 saying, "Do not go in there and do that " That was presented
10 from when I arrived as, that's an area in which you could go in
' and interrogate the detainee

12 Q In terms of training though, were you experiencing
13 that or at least folks knew it was common practice of doing an
14 interrogation immediately in the cell?

15 A We reviewed our plan as to where the detainee would
16 sit or stand. So in terms of other than like personal knowledge
17 of self defense and knowing that my number one protection of the
18 team that goes in with me is the protection of my interpreter,
19 which is always closest to the doorway for safety reasons,
20 followed by the analyst, if you have a supporting analyst there,
21 and then myself, or the interrogator last. In that term, when I
22 have utilized doing an interrogation in the cell, the detainee
23 would sit down and you would be standing, so to make it not a--

1 at least you have a partial advantage if there were something to
2 go awry

3 Q Well, it's pretty confining in that particular area.

4 A Yes

5 Q Are the doors typically closed when the interrogations
6 are being conducted?

7 A When the segregation section was full and you had say,
8 for an example, four people brought in, you know, suspicious or
9 caught in the act of placing IEDs. They have personnel that had
10 been in segregation that were customarily in the same general
11 area. So, you would close the door to try and muffle some of
12 the sounds of the interrogation because once it goes out,
13 everybody talks and there's so much cross-chatter as far as the
14 environment of the interrogation. Because at that point in
15 time, we didn't have a hard site so----

16 Q Exactly, that's my point

17 A Yeah

18 Q You were pretty much in a common area, regardless of
19 the situation

20 A Yes

21 Q And we visited the JDIC, the interrogation room is
22 rather confined there, as well. In other words, contents and
23 other individuals are viewable on the other side of the tier are

1 pretty much held in strict conference. So I'm rather curious as
2 to why the practice, whether common or not, of doing the
3 interrogation in the site themselves, where exchanges, questions
4 and answers could potentially be heard by the other detainees,
5 in that regard.

6 A My feeling was, it was a push for operations, keep
7 operations going.

8 Q But at the same time though, it's also safeguarding
9 information. So I convey that to you because the contents of
10 your interrogation and the contents of the information that you
11 gather are of a sensitive nature. Is that right?

12 A Yes.

13 Q Is there a practice today about conducting
14 interrogations in the cell?

15 A. I would say short of going up and asking questions,
16 not for interrogations as previous. Like it's not uncommon for
17 me to go in and visit my detainee. I would report to the
18 detainee. I'd go in and ask common questions. I don't ask
19 tactical or strategic questions. So, once we've been afforded
20 the opportunity to expand our interrogation setting, the
21 sensitive questions are dealt with in that environment, the
22 general familiarities and rapport building are what the focus
23 is, and only the focus.

1 Q Post-interrogation, you've concluded the interrogation
2 of a particular detainee, and then the additional information is
3 conveyed to the MPs in terms of a sleep management, meal plan or
4 terms of isolation, segregation, that sort of thing. How is
5 that conveyed and to whom is that conveyed to?

6 A Post-interrogation, you conclude, you go back, you
7 return the detainee to the possession of the MPs. Regardless if
8 things went well or unwell, say, a lot of times the MPs will--
9 you don't discuss the details of the interrogation.

10 Q Sure

11 A What they will ask, you know, "Was he cooperative?
12 Was he not?" "He was all right, so, so," whatever. And
13 pertaining to the meal management, because, at least in my
14 situation, I've been in the visibility of the detainees, I've
15 had to continue to be diligent as to what we do. I brief the
16 MPs as to, "Okay, what's the reaction been when you check on the
17 detainee," as to the common characteristics. "Has he been
18 responsive? Has he been staying awake? What's the response
19 been to, you know, on an approved plan where he gets 20 minutes
20 of sleep? A few hours later, he gets a 50-minute block of
21 sleep. And we want to know how he's responding. Is he staying
22 awake? Is he fighting, resisting? Trying to get feedback and

1 go either way. So that, in terms of debriefing, and that's what
2 we're doing, we want to make sure.

3 Q In your statement, you mentioned that, you described a
4 sleep management, meal plan, that the instructions are given to
5 the MPs, that this particular detainee would get only 4 hours of
6 sleep over a 24-hour period.

7 A That's correct.

8 Q You stated that that's provided to them in written
9 form----

10 A That is provided--yes, that's provided to them in a
11 written format that has to be approved. I write it up, it goes
12 to the CID. From there, it goes to Colonel Pappas. As long as
13 everything is within the rules of engagement, which he's
14 approved to sign off on, then signed back to me. They do look
15 at the schedule of what the hours are, when it starts, when it
16 finishes and when the detainee will get sleep. We calculate the
17 minutes and make sure it's 240 minutes every 24-hour period of
18 time

19 Q Total

20 A Total And as well as, after 72 hours of the sleep
21 management program, or sleep, meal management program, then they
22 get 12 uninterrupted hours of sleep. And then they can resume
23 the program again

1 Q. One more time. And then it's given back to you, do
2 you give that to the MP guard or do you give that to their
3 supervisor?

4 A. From when I've joined him--when I first started doing
5 it, it was handed to the Alpha/Bravo NCO who was located there.
6 And that's just been a customary practice, is to give it to them
7 and they verbally hand it over when the shift changes.

8 Q. And they execute it

9 A. Right.

10 Q. The only reason why I say that is because, you give it
11 to a guard, a guard during the day, let's just say for example,
12 is that his understanding may not be conveyed to the next guard
13 relieving him on the shift. And if it's understood that it's 4
14 hours is every 24 hours and not counting for all the minutes to
15 accumulate to 240 minutes, you know, don't you think--curiosity,
16 or do you care whether that's being conducted properly or do you
17 monitor that or do you leave that to the conveyance of the guard
18 that's executing that set of instructions?

19 A. My experience has been when I've given it to the
20 NCOIC, they've reflected that they are the one in charge and
21 that it was their responsibility to hand it over to the next
22 shift, except they do shift briefs. So when that's conveyed to

1 me, and that was the operating procedure from what I understood
2 from a VOCCO, verbal, that's the language that I proceeded----

3 Q Did they show you any kind of record of all that they
4 are--10 minutes here, 20 minutes there? Did they show that to
5 you?

6 A Given that it's on the schedule, they have--you know,
7 when I go down and ask, "How's everything going? How's the
8 program going?" They say, "Yup, fine, things are going fine "
9 Some MFs check off the times, making sure they go through and do
10 it Others, I've never seen a logbook of them monitoring and
11 managing, that sort of thing

12 Q Provided it's conveyed to you that you've accomplished
13 the mission What about isolation and segregation? Two
14 different things, is it isolation and segregation, or just
15 isolation----

16 A I've been informed that the new word for Alpha wing is
17 "segregation " We don't use "isolation" in our terminology.

18 Q When were you informed of that, the new terminology?

19 A The last couple weeks

20 Q Just the last couple of weeks? But the distinction
21 wasn't made then, it's just one terminology----

22 A One terminology for Alpha Wing, Alpha/Bravo Wing,
23 that's isolation.

1 Q But in terms of isolation though, I'm sure you're
2 involved with providing that type of a recommendation, approve,
3 whatever the case may be, as part of the post-interrogation
4 process. When you gave that sort of instruction, did you
5 stipulate anything of a special treatment, especially in the
6 sense of a negative as a matter of punishment?

7 A In terms of a punishment in a special treatment, as I
8 clarified in my written statement earlier, my definition of a
9 special treatment was to--I have one particular detainee I've
10 been working for a good reasonable amount of time. The detainee
11 didn't like getting a shower. There was no reason why the
12 detainee couldn't have a shower in a reasonable, timely fashion
13 and made sure he had well grooming standards. The reason was
14 for that was because the way in which the detainee was at the
15 point of capture and significance of the facial hair, the hair,
16 in and of itself on the being, and what that represented as part
17 of the approached plan. So, to neutralize that in the setting
18 of the interrogation was why that was recommended.

19 Q To isolate him

20 A His special treatment was, I had quite often said,
21 "Please make sure his beard is shaved. Please make sure his
22 head is shaved. Please make sure he gets a shower. Please make
23 sure he takes care and brushes his teeth, because he has really

-

1 bad oral hygiene." When you're close and interrogating in a
2 small room, it's rather pungent. So, that is what my definition
3 of special treatment is and was very well defined.

4 Q In terms of isolation, have you ever given
5 instructions to the MPs that isolation is required for a
6 specific detainee or any detainee for that matter, to be
7 interrogated?

8 A You mean, throw him in the hole?

9 Q Right.

10 A Only if had that, you know, if it's part of my plan.

11 Q If it's part of your plan.

12 A Yeah.

13 Q Let me ask you this, in your experience as both in the
14 military and civilian. What is your understanding of isolation
15 and for how long would you isolate----

16 A A detainee, in terms of this environment, through my
17 experience has been according to our rules of engagement, is 30
18 consecutive days. After that, it needs a written statement,
19 memorandum for the record. It needs to go up to General Sanchez
20 asking for an extension for an additional 30 days.

21 Q Is there any understanding whatsoever of the
22 requirements of checking a detainee every so often within a
23 period of 30 days?

-

1 A You mean have I ever left a detainee down there just
2 for 30 days and not check on them?

3 Q Not you, per se, but the MPs.

4 A No----

5 Q Because you're the experience one and all the MPs are
6 going to do is follow your instructions as approved by competent
7 authority. A detainee is placed in the hole, as you call it,
8 for 30 days. Is it common understanding or your assumption that
9 the MP is supposed to check on them every 15 minutes----

10 A If you're talking about "the hole," the MPs are
11 supposed to--the MPs have informed me verbally that they take
12 the detainee out for regular bathroom breaks. They make sure
13 the detainee is fed, unless it's specifically requested by an
14 interrogator as something, for an approach, that they have the
15 appropriate amenities that go with them in the hole, such as
16 water, food, they are fed. They're not to remove that unless
17 it's part of an approach where they're on bread and water or
18 something along that line. I've never seen--I've seen extreme
19 cases, but I've never encountered that.

20 Q You've never encountered that at all.

21 A No.

1 Q Have you ever given a set of instructions to the MP to
2 put anybody in isolation during the course of your employment
3 here from the 5th of October until now?

4 A Not without my approval plans, not that I can recall.

5 Q Since you have access to Tier One A and Tier One B,
6 are you familiar with the guards and their guarding those
7 detainees in those cells? I'm not interested in---

8 A No, I mean, when I go down there, I say "Hi," and see
9 their faces and things along that level.

10 Q Could you name some of those guards that were guarding
11 those detainees in those cells?

12 A Given the nature, I rarely use my name down there, and
13 only probably four of the MPs, I only use their surname.
14 Because of security reasons, I don't want anybody to know my
15 name down there. So, I know Sergeant [REDACTED] he's one of the
16 strong tier leaders, Sergeant [REDACTED] who works the other shift,
17 excellent strong tier leader, Sergeant [REDACTED] and
18 there's I can't remember the name of the other one. Then I'm
19 familiar with the faces of other people down there and I can
20 point them out and say, "Yup, I know the guy may have worked
21 this shift," or "I've seen him on this shift."

22 Q Is it a common practice for you as approved by the
23 chair of command not to reveal your identity?

1 A. It's a common practice to use a pseudo name, if you
2 need to, especially in that environment. At least that's been
3 verbally portrayed to me.

4 Q Portrayed to you as approved by the chain of command?

5 A If it's in writing, that I don't know.

6 Q Did you ever ask?

7 A No, I have not.

8 Q Have you used that technique before?

9 A I only go by my name in Arabic, is [REDACTED] and that's
10 my proper name

11 Q Well, you're a pretty imposing individual, large
12 individual, could be construed as very intimidating and you have
13 been named by some of the people as [REDACTED] and there are other
14 [REDACTED], I believe, that are also interrogators in that regard
15 Was it to your self protection not to be identified? I think
16 you also wear civilian clothes.

17 A Yes, I do.

18 Q It's a common practice?

19 A Yes.

20 Q And you don't think, or you do not know whether that
21 particular practice is approved by your chain of command.

22 A To use a pseudo name?

23 Q To use a name, to use your real name.

1 A It's something I've never addressed I've just known
2 other people to use other names, other interrogators, military
3 and civilian. I like to use different names when I go in a
4 booth

5 Q. But you're not CIA or DIA, you're a civilian
6 contractor

7 A That's correct.

8 Q The reason why I ask that is because I've asked
9 commanders if that was common practice, and they said it was not
10 a common practice.

11 A It's very different amongst the troops then

12 Q This is going to be one of my recommendations, that
13 there be a standard operating procedure because the MPs that you
14 know that you're interacting with, you know them, or at least
15 their rank because they're wearing----

16 A Their uniform.

17 Q Within the context of those MPs, in the performance of
18 their duties, do not know who you are They commonly refer to
19 you as an MI interrogator They think Mr Israel, for that
20 matter, is an interrogator, when in fact, he is not. He is part
21 of the interrogation team And for that matter, he's not
22 involved with your plan other than what you brief him on. So, I
23 think it's rather unusual that it's commonly practiced here,

1 especially in the context of what we call "detainee operations,"
2 Mr [REDACTED] especially in the context of your understanding
3 of the Geneva Convention, and without checking into the legal
4 implications of that particular context, you could be held
5 liable for anything as an employee of the United States
6 Government. Protection, obviously, is okay, but this being a
7 common practice, and my recommendation would be that it be made
8 a common practice to govern and protect the interest of the
9 United States Government inasmuch as we protect the interest of
10 the detainee.

Have there been any changes--I'm sorry, let me go
12 back. Are you aware of all the allegations that were made or at
13 least the investigation that was conducted by the Criminal
14 Investigation Division of allegations of detainee abuses by
15 guards that you know of that were associated with performing
16 their duties in Tier One A?

17 A No, I'm not, only by rumor.

18 Q Only by rumor.

19 A Yes.

20 Q So you don't know what Corporal [REDACTED] did or what
21 Sergeant [REDACTED] did?

22 A No.

23 Q Or Sergeant [REDACTED] did, none of that?

1 A No.

2 Q. What was those rumors? What did you hear?

3 A. The rumor I've heard is that videos and pictures were
4 taken of detainees, some performing illicit sex acts, or some
5 other type of act, and it was filmed.

6 Q It was filmed?

7 A Yes

8 Q Other than taking photographs of detainees for
9 identification, have there been instances of detainees being
10 photographed for other than identification purposes that you
' know of?

12 A That I know of, no

13 Q Not any videotape or not in the conduct of an
14 interrogation?

15 A No, because at this point, we don't do--other than
16 when they first come in screening, that's their only picture.

17 Q Not at all

18 A No

19 Q Okay, based on what you heard through rumor of
20 detainee allegations--I'm sorry, detainee abuses and
21 maltreatment, was it conveyed throughout the command, 205th or
22 whoever else that you were placed under, of any changes

1 whatsoever to be made with regards to detainee and interrogation
2 operations?

3 A From that, we were no longer would conduct
4 interrogations in segregation, Alpha/Bravo. There was no formal
5 command gathering and saying, "These are what the allegations
6 are These are the things that are happening." It felt like a
7 type of non-discussion

8 Q Were those changes conveyed in a written form or a
9 formation of sort or a briefing by the commander or chain of
10 command?

11 A The--I was told by the section sergeant that we are no
12 longer doing interrogations in segregation.

13 Q When you first were informed of that, were you in a
14 meeting of some sort?

15 A No, I was with my sergeant--my section chief.

16 Q Provided you that information that you were no longer,
17 as a matter of practice----

18 A That's correct.

19 [The interview paused at 1217, 12 February 2004, and reconvened
20 at 1225, 12 February 2004]

21 Q We just want to refer back to a previous question I
22 asked you with regards to the implementation of the treatment
23 plan, what I'll refer to as a treatment plan after an

1 interrogation, that would be in the context of a sleep
2 management, meal plan, SMMP, or placing somebody in the hole, as
3 you referred to. But before I do that, what exactly is "the
4 hole"?

5 A It's the--when you went into the Alpha wing, just
6 say.

7 Q Bottom floor, top floor?

8 A Bottom floor, first cell on the right-hand side, steel
9 door--or a metal door, and it's just a room in the wall, a
10 concrete room

11 Q A concrete room, no light, it would be just a bare-
12 sided wall with a steel door. Is there any other access to that
13 like besides the door, itself, that you recall?

14 A You can't--I don't think you can lift it up, because
15 they've always opened it up to check in on the detainee. I
16 don't know if----

17 Q Is there a little peephole----

18 A Yeah, I don't know if that works. I've never seen
19 anybody use it. I actually think it's welded shut.

20 Q Okay. So, it's welded shut today. Was it welded shut
21 before?

22 A As long as I know, that hasn't worked. A lot of the
23 mechanical components in certain areas haven't worked.

1 Q But it was typically referred as "the hole," or
2 "throw in the hole."

3 A Right.

4 Q Do you know if anybody else, any of your
5 interrogators, associates referred to it as--or even intimated
6 to an MP to place somebody in there?

7 A I mean, it's commonly used. I mean, I've known, like
8 the MPs, they've had a detainee who stuffed their toilet full of
9 a whole mattress that they tear up into pieces, they will take
10 the detainee out, and then as a form of punishment, will throw
11 the detainee in the hole

12 Q All right, so it's not exclusively just the
13 interrogators

14 A No, I mean, it's been for behavioral discipline,
15 people from Ganci, detainees coming over from Ganci who--and
16 things along that nature

17 Q Let me ensure, for a point of clarity here, that when
18 you gave a set of instructions to an MP to implement the sleep
19 management meal plan or whatever other set of instruction, you
20 mentioned that you conveyed that to the guard once it's approved
21 by the chain of command, typically a warrant officer or
22 [inaudible], up until that time, it was only approved up to
23 whom, Colonel Pappas?

1 A If it was within the--like the sleep--like staying in
2 segregation for more than 30 days, everybody knows that goes to
3 General Sanchez.

4 Q But before.

5 A That has been the whole case Colonel Pappas, you get
6 your--you fill out the request to put the detainee in
7 segregation You put the detainee in segregation--well, you'd
8 send forward your request, give it to the chain of command. And
9 when it came back, then you'd put the detainee in segregation.

10 Q But your understanding was that General Sanchez was to
11 approve that.

12 A Right.

13 Q But before then, has it always been like that since
14 you arrived----

15 A There's been circumstances where they've been able to
16 put the--they said, "It's okay, go ahead and put the detainee
17 in----"

18 Q Pending approval?

19 A Right So that, I have seen in the past

20 Q Because Colonel Pappas was not there until after the
21 19th of November.

22 A Right

1 Q So typically, then, the--would approve such a
2 practice, or at least give authority----

3 A. It would be Colonel [REDACTED]

4 Q So, that's provided, given to the MPs, assuming it was
5 done properly. Then you mentioned that then he would rely then,
6 without your interaction on that being executed with the
7 intention----

8 A Uhm hum

9 Q And there's no checks by you whatsoever.

10 A Other than on our own accord to go down and look after
11 our----

12 Q Checks

13 A I mean, there are no other--no, there isn't a regular
14 schedule to go down and make sure the detainee has received
15 this I mean, it's the initiative of the team or the operation,
16 itself

17 Q So, that procedure is where a set of instructions
18 identifying the term, provided to the MP for execution with
19 a ..how would you call it, precise supervision other than what
20 the MP understood his instructions to be. In other words,
21 everything is relegated to the MP to execute that term.

22 A Yes

1 Q And that's common practice, I take it. But do you
2 feel that kind of strange that I'm giving my own set of
3 instructions for somebody else to execute, that in the case
4 where something happened to that detainee and that MP is then
5 held liable for that set of instructions?

6 A. I feel it strange that when I've asked for rules of
7 engagement for the MPs and standard operating procedures for the
8 MPs, that they requested one, the people who work the hard side
9 requested one from the chain of command and they didn't have one
10 to provide myself.

11 Q The MPs

12 A Yes

13 Q You requested what their detention rules of engagement
14 were?

15 A Exactly Yes, I find it curious, and I have asked.
16 Have I written it up? No, but I have asked on numerous times as
17 to the specifics in detail for the rules of engagement other
18 than what is on the rules of engagement in the signature block
19 that we go through.

20 Q I would find it curious, as well.

21 A As you should

22 Q. You're providing a set of instructions to someone to
23 execute, and if something ever happened to that detainee, you

1 would find it curious, as well, and interesting that you would
2 be held liable for that. Of course, a lot of that could be
3 either misinterpreted or misunderstood or just easily
4 understood

5 Now, the rules of engagement here today that you said
6 were not the same, were somewhat revised based on things that
7 have happened in the past. The improved interrogation
8 operations and operation procedures, were those the same ones or
9 somewhat adjusted to meet the current operating environment?

10 A I guess these are the ones we use now or the ones we
11 use back then

12 Q Before Colonel Pappas showed up.

13 A I can't answer the question because we've had at least
14 five iterations that I've signed on rules of engagement changes.

15 Q Just your best

16 A I think they're pretty much the same. Actually no, I
17 think those are the one--Colonel Pappas came on board, these
18 came on. I mean, the intent was there, they're just written on
19 a different format. This, like I said, this didn't come out
20 until.

21 Q After he showed up.

22 A Right

1 Q Notice in the right-hand column there, there are two
2 things that come to mind right now, the use of military working
3 dogs, you made a statement that said basically that you
4 commented on that you noticed dogs that were either conducting a
5 search or just their presence, that indicate on here, the use of
6 military dogs today must receive CG's approval. So your
7 understanding was, the presence of military dogs was a common
8 practice at that point in time, whether they're being held or
9 being used for searches or for other purposes?

10 A My interpretation was, if you were going to be in a
11 formal interrogation setting in the booth with a planned
12 interrogation procedure, that's where that approval needs to be
13 met. In terms of, if you're in the environment of whether it's
14 in Vigilant, Ganci, we used to be--in the civilian population
15 until they modified our access for safety reasons. We're not
16 allowed to go into Ganci or Vigilant, that presence of military
17 working dogs was a normal occurrence. That was my
18 understanding.

19 Q That's your understanding. Relative to that, there
20 was Ganci, Vigilant----

21 A As well as isolation, meaning all the detention
22 facilities.

1 Q The process that which just the operating environment
2 there today, Ganci is pretty much an open environment, even
3 though you had Camp Vigilant exposed, so is Vigilant for that
4 matter So the only ones that are confined in the term of this
5 particular environment was that at JDIC where you hold the
6 interrogation, or even the hard site was exclusively separated,
7 confined, and not exposed. Do you agree with that?

8 A That it's an exclusively confined space?

9 Q Right, you're not exposed to any observation
10 whatsoever because you're not conducting, at least that we're
11 aware of, including interrogation inside of Ganci or Vigilant,
12 because any interrogations, the detainee is removed from that
13 particular site to another site

14 A At one point, you could conduct an interrogation at
15 Ganci

16 Q Is there a facility at Ganci to---

17 A Each Ganci compound, I think, I don't know if there's
18 more than eight now, I know it's grown a lot since it's been off
19 limits---

20 Q It's a big compound

21 A Each compound has its own command tent. And within
22 the command tent, you could probably fit three or four, you
23 know, in a living space. You know, a couple tables and you

1 could sit in there and ask the detainee questions and
2 interrogate the detainee there.

3 Q. But in the same environment as that, you would find
4 the JDIC. In other words, they're confined----

5 A. You can find---

6 Q. ----enclosed so nobody else could hear comments or
7 answers or responses to the questioning associated with that
8 particular interrogation?

9 A. I mean, let me make sure I didn't--yes, they're
10 completely,

11 Q. Just so I understand, have you ever done any
12 interrogations in Ganca or Vigilant?

13 A. Yes, I have.

14 Q. But not in a setting where people could hear the
15 questioning and the responses.

16 A. In the back of the tents right there, it's right next
17 to the compound and the detainees are walking around. I mean,
18 they're only 10 feet away. You ask the MPs to keep the
19 detainees away and they pretty much just go about their
20 business.

21 Q. So that's kind of a common practice, an established
22 practice.

23 A. Right.

1 Q. So in all of the guards now, based on your
2 understanding today on these current rules of engagement, things
3 like change of scenery, dietary manipulation, sleep adjustment,
4 isolation for longer than 30 days, sleep management, 72 hours
5 max, sensory deprivation, 72 hours max, must be approved by the
6 Commanding General, as you know it today. This is how you
7 understand it? Since it's posted in the common area----

8 A Right, yeah. I mean, sleep management. .

9 Q In excess of----

10 A In excess of 72 hours.

11 Q Right.

12 A And any of the ones I've done, they're never in excess
13 of 72 hours They've always mandated--I've always made sure
14 they have actually had more time than the 12-hour minimum And
15 usually, it's been, on average, one day.

16 Q During our tour of the facility, you mentioned that
17 instructions are given to the guards. In one particular
18 document that we saw that was signed by a warrant officer
19 basically said, prisoner isolation, segregation, dated the 4th
20 of February. You mention it is now, the terminology that is now
21 used, "segregation " This particular memo, we saw "segregation"
22 and "isolation" signed by the warrant officer. Now, you said
23 that they might approved by the chain of command. In this

1 particular memo, it didn't stipulate how long for isolation or
2 how long for segregation. Are you aware of maybe perhaps there
3 is still a misunderstanding of sorts common to the chain of
4 command that establish procedures when they have not been
5 clearly understood?

6 A Yes. And the reason--when that was clarified to me it
7 was by the JAG officer, Captain [REDACTED] who specifically--
8 when I worked with him. More recently, prior to his departure,
9 was "No, the proper terminology is 'segregation'."

10 Q Not both.

11 A No, it was spelled out very clearly to me. We don't
12 use that word, it doesn't exist. It is segregation. I've even--
13 the way in which I wrote my notes and everything, it comes out
14 "segregation."

15 Q All right, I just want to confirm the commonality of
16 consistency

17 Well, I don't have any more comments, sir. So, I'd
18 like to ask you though, your recommendations to improve the
19 environment with regards to detention operations. I mention to
20 you that detention operations is not an isolated operation
21 There is a purpose to why those people are being detained, and
22 that's, of course, your role in that matter of collecting
23 information, collecting intelligence whereby it is a useful set

1 of circumstance for them.... So what will be your
2 recommendation now that you've been here for 4 months?

3 A The MP mission, whether that remains an MP mission or
4 becomes commercialized, the MI operation, they need to
5 amalgamate in one form or another.

6 Q One centralized .

7 A The MPs, if they're going to be running it, as far as
8 I know today, there is not a JAG officer on site to advise the
9 MPs I asked, "Do you have a JAG officer? Where's your JAG
10 officer?" Because we refer to ours, if needed. And she said,
11 "We don't have one on-site " So, they didn't have access to
12 their tools Having them meet an operating procedure that works
13 for both and everybody's clear on it, everybody's briefed on it.
14 And a continuous, no verbal deviations of the rules of
15 engagement That's--why have the rules of engagement if you're
16 going to verbally change something or approve something or to
17 approve something verbally It totally throws your rules of
18 engagement off and makes them void, in my eyes Having a
19 liaison rep that works and dedicated if they're going to
20 maintain a large presence of people in segregation, that they
21 are coordinating with the MPs, they're coordinating with MI, and
22 they are briefing the teams If that thing does happen, that
23 they brief the whole section The International Red Cross just

1 came through not that long ago Not one brief, and I've asked
2 all the way up to the JAG, from the MI, "Please give us a brief
3 so the troops and everybody else can learn what the value of the
4 Red Cross visit was. They're not bad guys They're good guys."
5 And they're saying "Yes, yes, we'll do one." Well, they're
6 gone Nobody knows why the Red Cross was here. The 202d is in
7 now They will not gain any value from the Red Cross visit
8 other than the command who, what was transferred over to them,
9 but the troops won't The information is not flowing down. You
10 do a formation They do them two, three times a week for the
11 military members They could do a better job of disseminating
12 information from a strong command presence, not necessarily just
13 from an MCIC or OIC of the operation.

14 I think the training that, you know, techniques,
15 things from Huachuca for interrogation, analyst skills, the
16 development skills are coming along really well. There's a lot
17 of self-initiated programs, so I give him hats off for that.
18 But maintaining with what we are protecting our assets and
19 protecting the detainees, we really, continuously need to
20 reemphasize And you know, I offered and have helped
21 participate in providing that, you know, going into the
22 direction If you have a complaint, you need to muster up and
23 have a solution if you're going to jump in and do it. So, I

1 think everybody who works in there needs to--it's the same
2 attitude for everybody.

3 Q A common understanding is what.... Were you aware--
4 just one more question, please. Were you aware of a visit by
5 Major General Miller, who is the Commanding General of GTMO? At
6 least his presence or anything that was cascaded down to you.
7 That happened in October or November

8 A I remember hearing of--I think that was right when we
9 received a lot of DVs, and he--I heard that he was coming in. I
10 don't know if he ever came in, because I never seen or met the
person I don't know.

12 Q Nothing was conveyed as to the purpose of his visit
13 or----

14 A The purpose of his visit was not conveyed.

15 Q What about General Ryder, who was the Provost Marshal
16 of the Army, who has also visited the facility?

17 A I am not aware of that

18 Q Okay, do you have any other closing comments that you
19 want to convey?

20 A No, sir.

21 [Mr ██████████ was duly warned and the interview concluded at
22 1245, 12 February 2004.]

1 [REDACTED] was interviewed on 12 February 2004, as
2 follows.]

3 Q. Have you been informed of the nature of our interview
4 today?

5 A. I would like you to explain to me exactly. We did
6 some investigation back in Abu Ghraib, and I would like to--if
7 you could elaborate on that a little bit more.

8 Q I would be very happy to do that for you before we
9 start I just wanted to preface that by saying, if you have any
10 knowledge, whatsoever. I am Major General Taguba. I'm the
11 Deputy Commanding General of the Coalition Land Forces Component
12 Command that is headquartered at Camp Doha, Kuwait My
13 commanding officer, Lieutenant General David E. McKiernan, the
14 Commanding General of the Coalition Forces Land Component
15 Command has appointed me as the investigating officer under the
16 provisions of Army Regulation 15-6 That was under the
17 direction of General John Abizaid, the Commander of Central
18 Command Our investigation is to gather all relevant facts and
19 circumstances surrounding recent allegations of maltreatment of
20 detainees at the Abu Ghraib prison, also known as the Baghdad
21 Central Confinement Facility, as well as the detainee escapes
22 and accountability lapses as reported through CJTF-7. And my
3 inquiry will further investigate training, standards,

1 employment, command policies and internal policies concerning
2 the detainees held at the Abu Ghraib Prison. And finally, our
3 inquiry is to assess the command climate and the supervisory
4 presence of the 800th Military Police Brigade and chain of
5 command. I also want to advise you that our interview is being
6 recorded so we can capture the accurate questions and responses
7 that you will provide. Do you have any questions about the
8 scope?

9 A No, sir.

10 Q For the record, please, would you please state your
11 full name?

12 A My name is [REDACTED]

13 Q And your social security number?

14 A [REDACTED]

15 Q The nature of your employment?

16 A I am a linguist. I was hired by SOS, Titan firm, for
17 the Army

18 Q So you're principally an interpreter?

19 A Yes, sir

20 Q Do you do any interrogations at all?

21 A Not myself

22 Q Not by yourself?

3 A No

1 Q. But since you're an interpreter, are you interpreting
2 for the interrogator and translating for the detainee?

3 A Absolutely.

4 Q Good. How long have you been doing this now?

5 A Since October 14th until now.

6 Q Until now. Who are you, since you're a civilian
7 contractor hired by Titan, who is your chain of--who do you
8 report to?

9 A As far as civilian matters or military matters?

10 Q Military matters.

11 A Well, we have Sergeant--in the beginning, it used to
12 be Sergeant [REDACTED] then to be honest with you, I forgot the
13 name because we kept shifting from team to team. But my
14 immediate guy who was in charge was [REDACTED]

15 Q He was a civilian or military?

16 A He was a military--he was taking care of our
17 businesses for the linguists

18 Q Who is your immediate military supervisor? Do you
19 have one?

20 A Well, usually it's my interrogator, [REDACTED] And [REDACTED]
21 has another guy to report to. Because we're working on a
22 special project, and he has to let him know about my situation,
3 and from there, through his report, he has to tell other people.

1 Q But did you understand that there's a military
2 commander above the things that you're doing?

3 A Yes.

4 Q I understand you work with civilians.

5 A No, I know. I forgot his name, Major [REDACTED]

6 Q Major [REDACTED] was?

7 A Major [REDACTED], at that time, it was Major [REDACTED]

8 Q When did you arrive at Abu Ghraib?

9 A October 14th, I believe, either the 14th or the 15th

10 Q Did you do any other interpreting, translation job
11 before then?

12 A No, sir

13 Q So you were assigned to Abu Ghraib?

14 A Yes, sir

15 Q Were you hired back in the United States or were you
16 hired here?

17 A No, back in the United States

18 Q At that point in time, were you advised of the nature
19 of your job?

20 A They told us it could be in the field, could be
21 anywhere. If I took the job, regardless of what the situation
22 was

1 Q. When you arrived at Abu Ghraib, did anyone explain to
2 you the nature of your job?

3 A. Yes, indeed, Chief [REDACTED] and they give us like a
4 little seminar of what's going on, what's going to happen,
5 what's the limitations, what you're supposed to do, what not to
6 do. If you see anything wrong, you're to report it immediately,
7 and things like that.

8 Q. So you received a briefing and a seminar.

9 A. They did give us a briefing, yes, sir.

10 Q. How long was that training?

11 A. That's a good question, an hour, give and take. To be
12 honest with you, I don't recall, but I think it was a lengthy
13 one, because they went through all the procedures.

14 Q. Did they give you, beyond that, the conditions and the
15 personnel that are being held at Abu Ghraib prison, did they
16 give you additional instructions or information with regards to
17 the nature of the operating environment?

18 A. Yes, and no. The reason, for example, they told us
19 what our limitations is. We have to be with an interrogator and
20 we have to have an analyst and things like that. We cannot--we
21 have to stay with the detainee. If we see anything wrong, we
22 have to report it and things like that. And they told us, "If
3 you don't like the environment, you just could stop and walk

1 away and you could report immediately any abuse incident," and
2 things like that.

3 Q What were some of those limitations that you talked
4 about? What were you authorized to do in your job performance
5 and your role as a----

6 A My job is just a translator, no more, no less.

7 Q No more, no less?

8 A That's it

9 Q Okay, all right Do you have any knowledge,
10 whatsoever, of the Geneva Convention?

11 A Yes.

12 Q Was it ever instructed to you, or were you given some
13 sort of a piece of paper that basically said, "Anything that we
14 do here or not do here is governed by the Geneva Convention"?

15 A Yes, indeed, they mentioned that.

16 Q Who mentioned that to you?

17 A To be honest with you, I don't recall, but I remember
18 the detainees' rights and things like, human rights and things
19 like that They do mention it, but exactly, I don't recall, to
20 be honest with you.

21 Q But they did not give you any written references, Army
22 regulations or field manuals or SOPs to read?

1 A I believe they gave us some paper to read, and we had
2 to sign it at the time. But the details, I don't recall, to be
3 honest with you, but I signed two papers, I believe I signed.

4 Q Do you recall what you signed?

5 A. Some of the procedures, the limitations for the--if
6 you see anything wrong, you have to report it, anything unusual,
7 you have to report it and things like that. But to be honest
8 with you, Geneva Convention, I might have read it. I might have
9 signed it, but I don't recall too much.

10 Q Do you know what the Geneva Convention is?

11 A You know, how to--if somebody has a prisoner of the
12 war, you have to treat them nicely, because it's a mutual
13 situation. We could be detainees on the other side, so there is
14 rules and regulations, like that effect his personal rights and
15 things, you know. There's limitations for everything.

16 Q Did they explain to you how your employees would
17 protect you should you be detained by Iraqi or anti-coalition
18 forces?

19 A That's a good question, I don't think so.

20 Q They never explained that to you.

21 A No.

22 Q That you could be detained at any time by other people
3 that were anti-coalition forces?

1 A That's a good question. I can't answer that, sir. I
2 don't recall

3 Q You don't recall that being explained to you?

4 A. I don't recall. They might, but I don't recall. If
5 they mentioned it, I might--it's a great question.

6 Q Did they explain to you if you get hurt or if you die
7 here or you're captured----

8 A They gave us a file. They said, give it to the
9 immediate people just in case something happens to you, they
10 have the record. They have things, the next of kin and things
11 like that

12 Q Let me move forward now with the context of your duty
13 as a translator purely for doing the interrogation period. And
14 I'm not looking for anything specific or the contents of the
15 interrogation, specific contents of the interrogation. Could
16 you describe for me what typically happens, generally, in the
17 conduct of an interrogation?

18 A Okay, what would happen is usually the interrogator
19 goes to the MPs and says, "I want this prisoner," and they would
20 say, "Where do you want him to be?" If there's empty booths,
21 they will guide the detainee to that location. And then what
22 happens is the interrogator will set up the tables, the table
3 and the chairs according to the way he wants it to see fit.

1 I've seen some of the interrogators, they tell me to stay behind
2 the detainee. Some of the guys tell me to sit next to him.
3 Some of the guys tell me to "Sit next to me facing the
4 detainee ' And then they want to ask a question, then I have to
5 translate back and forth, from Arabic to English, from English
6 to Arabic

7 Q So it's never the same.

8 A Never the same

9 Q It could be, where we're sitting today, you're to my
10 left

11 A Right

12 Q And the detainee could be to the right, and the
13 interrogator could be in the middle

14 A Or sometimes what they do is they put the detainee in
15 the corner with a chair, and I will be sitting next to the
16 interrogator.

17 Q Okay

18 A Some of the interrogators, they have their own
19 preference They will say, "We want you to be--" they put the
20 detainee halfway in the middle I'd be behind him and they--
21 facing him--because some of the detainees, they like to see the
22 interpreter because he speaks the same language, they always go
23 like this [turning his head to the side]

1 Q. So it's not always the same.

2 A No

3 Q I got it. Prior to the interrogation being conducted,
4 is there a plan?

5 A. Yes, lately, they put a lot of emphasis on it. The
6 interrogator will say, "Okay, this is my game plan." Sometimes
7 he will say, "I'm going to ask him 12 questions, and don't
8 listen to him. Just translate my questions to him and don't
9 listen to what he's going to say." Or sometimes they will say,
10 "Okay, this is the game plan We're going to ask easy questions
11 and we want----"

12 Q So like a rehearsal?

13 A A rehearsal, absolutely

14 Q Is that in writing or is that given to you verbally?

15 A Oh, verbally. But he has----

16 Q You said "lately," now, you said, "lately," there's
17 been more emphasis on the interrogation plan.

18 A No, as a matter of fact, this goes back to September,
19 the beginning of September

20 Q And you arrived here in October

21 A In October, yeah I would say end of November or last
22 part of November, they put a lot of emphasis on that.

3 Q. You said this was typically done verbally.

1 A Verbally, yes, sir.

2 Q Did you see anything in writing signed by somebody?

3 A Usually, the interrogator will have the info, usually.
4 Because that's done by the interrogator, will brief us, we have
5 an analyst, and then we'll walk into the booth.

6 Q Please describe for me at the conclusion of the
7 interrogation what happens next?

8 A What happens, after back and forth session of
9 questions and answers, questions and answers, me and my
10 colleague, which is the interrogator and analyst, will sit and
11 he will try to absorb what happened in the room. And there will
12 be questions and answers. And he will say, "Did I miss
13 anything, as for as----"

14 Q Is this in the presence of the detainee?

15 A No, after we send the detainee, we go back to the ice
16 room----

17 Q Okay, let me back up. At the end of the session,
18 let's just say we just ended now and----

19 A Okay, I see what you're saying. In that case, what
20 happens is, one of the--usually the analysts are military.
21 What happens is they stay with the detainee and we'll go tell
22 the MPs that we're done and they will come and guard it. This
3 is--we are in the hard cell, in the ISO. But if we are in the

1 outside, what will happen is the analyst, which is the military
2 guy, personnel, he will guard the detainee--obviously he has the
3 handcuffs on. He will put them back on his hands. He will take
4 them where--if it's a walking distance to his camp or they might
5 put him in a HMMWV and take him back to----

6 Q To somewhere else.

7 A Yes, sir.

8 Q But let's just focus for a moment, those detainees
9 that are placed in the hard site, at the conclusion of the
10 interrogation, do you accompany the detainee back----

11 A Absolutely not

12 Q No?

13 A I cannot continue with it.

14 Q Okay And of course, you've never done that.

15 A No, no, sir.

16 Q So, those detainees then are given back to the MPs....

17 A The MPs and the MPs will-----

18 Q Take them back

19 A Okay, what we do also, for example, if we're in the
20 building, usually the analysts will go and tell the MP, because
21 sometimes the analyst would be a civilian. The interrogator
22 will stay with the detainee. I will be next to the interrogator
3 just in case, if he wants something, he wants to say something,

1 and I also will tell the MPs It's walking distance from the
2 second floor to the first floor, and they will come and guide
3 the detainee back to his cell.

4 Q Do you know at that time when the detainees are given
5 back to the MPs, whether there are additional instructions given
6 by the analyst to the MP?

7 A To be honest with you, I don't interfere with that.

8 Q But you're not aware of any instruction?

9 A No, sir. Usually, the interrogator will go back to
10 the MPs if they have anything that needs to be discussed.
11 That's their job

12 Q So the detainees are given back to the MPs and they're
13 placed back in their cell And then you said that now you and
14 the analyst will then review the process....

15 A And the interrogator

16 Q The interrogator, I'm sorry, will review the process
17 and to, they will ask, "Did I miss something?"

18 A As far as, for example, when he speaks Arabic, he
19 might mention a few things that I wasn't able to elaborate on in
20 detail I might say, "You know what, also, I think this is what
21 he meant "

22 Q Okay.

3 A Give him some example

1 Q An after action review

2 A Yeah

3 Q. But not in any kind of depth, type of a post-
4 interrogation review is the analyst asking you for your thoughts
5 in terms of what to do next.

6 A No, no. It's a matter of conversation that the
7 detainee was talking about just in case, you know, because a lot
8 of times in the Iraqi accent, there is a lot of things that he
9 mentions, so you have to be aware of that. Since I'm an Iraqi,
10 I know what they want to say, so I will try to help them as much
11 as I can as far as what he's saying.

12 Q Did you have any knowledge, whatsoever, to rumors or
13 direct knowledge of escapes or shootings or detainee
14 mistreatment in the Abu Ghraib facility?

15 A I heard about the escapee cases, but indirectly, but
16 we didn't hear it from the military, that aspect We heard
17 there was an escapee And the shooting, it happened, was a
18 quirk, we didn't know about it That night, we were supposed to
19 go on an interrogation with the same guy that started shooting.
20 It could've been me or it could've been the interrogator But
21 we knew about it like later on And that day, I worked from
22 almost 10 o'clock at night all the way to the next day until--
3 what was it, like 2 o'clock, 2 in the afternoon.

1 Q. So interrogations typically happened at any given
2 hour?

3 A Right, absolutely. We have a schedule. They have a
4 schedule. But in my case, because the shooting happened that
5 night, they didn't know what was going on. You know, they need
6 a linguist. So I stayed interrogating a lot of people because
7 they didn't know who got the gun, what's going on. So I
8 volunteered and I stuck there until the next day until almost 3
9 o'clock, and then I went home.

10 Q How many linguists or translators are working at Abu
11 Ghraib?

12 A That's a good question. As far as on my team, with
13 the MI, I would say about 16 or 15, because we have the
14 screening people that work in the screening. And we have the
15 interrogation team, I would say a minimum of 12.

16 Q Do you work with the same interrogator all the time?

17 A Lately, I work with the same interrogator because we
18 have a special case. But previously, I was with a team and that
19 team, maybe there's three or four interrogators, and I switch my
20 time with them. As soon as this guy's done, the next guy is
21 ready, I go with the next guy.

22 Q So it's not--you're just based on the need.

3 A On the need, yes, sir.

1 Q. So you knew about the shooting that happened. What do
2 you know about that?

3 A I would say like with the next----

4 Q. Do you know what month it was?

5 A That's a good question. I think it was December.

6 Q. December?

7 A. I think

8 Q And you were there when that shooting----

9 A No, we went and ate chow and----

10 Q You were in the facility.

11 A In the facility, yeah, and then. .I forgot his name,
12 he's transferred now He came and he said there was a shooting,
13 and he took a [inaudible] he's trying to [inaudible] and things
14 Because [inaudible] and we didn't know what was happening and
15 everybody was alert And he came and told us...Colonel [REDACTED]

16 Q Colonel [REDACTED]

17 A Yes, he came and told us the shooting happened and
18 this is what's going on And he did elaborate in detail as far
19 as what's going on He was very concerned And like after
20 that, they came and tell us, "We want some help with the
21 linguists " So that's how we got stuck until the next day.

22 Q Okay, let me fast forward now. Do you recall on the
3 20th of December, you were accompanying Mr. [REDACTED] and

1 Sergeant ██████ to the hard site whereby a prisoner was being
2 returned back to custody to the MPs and being accompanied by
3 Sergeant ██████ or a Sergeant ██████ Do you recall that
4 date?

5 A I met with ██████, but I don't recall
6 the details, honestly, because I go back and forth so many
7 times, I didn't pay attention, I didn't concentrate on the
8 situation, so it's hard to tell

9 Q Let me be a bit more clear on that. That particular
10 day was given as a date where a prisoner was given back to the
11 MPs where Sergeant ██████ and also Sergeant ██████ where
12 supposedly noises were heard when prisoners were being put back
13 in their cells, whether a prisoner was being--a detainee, I'm
14 sorry, was either falling down or was being struck by something
15 Do you recall that?

16 A No, sir, I honestly do not

17 Q Have you heard any comments from any of the MPs or any
18 of the interrogators or analysts regarding any rumors or direct
19 information in regards to detainee abuses?

20 A Honestly, no

21 Q You don't recall any of that at all?

22 A No, because what happens is a lot of times I walk
3 behind them. And when they talk together, I don't want to

-

1 interfere. Because once my job is done, I'm so tired, because
2 when I translate, I want to be fair for both parties. I don't
3 want to compromise anybody's situation. I'm so tired from
4 talking. Usually the session goes an hour, an hour and a half
5 just constantly talking back and forth from both sides. And
6 sometimes, you know, it's a peace of mind for me to keep quiet,
7 just walk to my place.

8 Q Is there a rule in the unit that you belong to now, at
9 the conclusion of the interrogation regarding whether it's the
10 same interrogator or a different interrogator, is there a rule
11 that states not to discuss the contents of that interrogation
12 with other translators----

13 A Yeah, absolutely, absolutely, especially in my case
14 with Steve. I have to be quiet. Even, I can't tell you
15 anything unless if you want to go ahead and ask, that's up to
16 you.

17 Q I'm not asking for the specific details----

18 A Exactly, but in my case, I usually keep quiet. He
19 tells me to keep quiet, but he knows I'm quiet. I don't like to
20 elaborate on my cases.

21 Q Did they give you a security clearance at the time you
22 were hired?

3 A My case is pending, sir.

1 Q. So your case is pending.

2 A. Yes.

3 Q. You don't have a security clearance at this time.

4 A. No, sir. I wish I could have one, sir. At least I'd
5 know I have a job for the whole year.

6 Q. Were you given an interim clearance?

7 A. To be honest with you, at that time, I didn't know
8 what the procedures were, but I knew that I was accepted, I'd be
9 able to go to Iraq.

10 Q. Do you know that you were supposed to have a
11 clearance?

12 A. I'm looking forward to it. I'm trying to do my best
13 to have a clearance, but that's all up to them.

14 Q. If you don't mind me asking you, Mr. [REDACTED], are you
15 an American citizen?

16 A. Absolutely.

17 Q. And how long did you live in the United States?

18 A. Since 1981, sir.

19 Q. So you've been there forever.

20 A. Absolutely, that's my country now.

21 Q. Since you were governed by the interrogation rules of
22 engagement, you're familiar with that. Did you know that to be
3 in writing, or was this just given to you?

1 A. I can't recall that, sir.

2 Q You can't recall? Let me show you something here that
3 states what the interrogation rules of engagements are. Are you
4 familiar with that?

5 A Yeah, as a matter of fact, they did one time, they
6 gave us this, we went over it, yeah.

7 Q. So you're familiar with that?

8 A Yes, because the reason I'm saying this, one of the
9 sergeants, she went in details, she went an extra effort with
10 her interrogators. And we were sitting in the meeting just to
11 know what's going on. And she went over the issues, explained
12 to everybody what's going on, yes, indeed

13 Q So there was a lot of explanation----

14 A Yes, yes, this goes back, I think, to December, mid-
15 December, I think. Don't quote me on the dates, I could be
16 wrong

17 Q You mentioned meetings. How often do you have these
18 meetings?

19 A Meetings?

20 Q General meetings, everybody there.

21 A When a lot of information happens, but as far as
22 meetings, usually, if something needs to be elaborated on, for

1 example, in that case, she gathered us, I think she spent about,
2 I think 2 hours, about 2 hours, yeah.

3 Q. About 2 hours.

4 A Yeah, it was a nightshift, I think. And she said,
5 "The reason I want you to be here for the linguists..." because
6 part of that wasn't our concern, it was just to know what's
7 going on.

8 Q Let me go back again just to clarify something. Up
9 until the time that you were hired, on or about the middle of
10 October, again, you did not receive any training or instructions
11 as to the nature of the job you were going to perform here in
12 theater.

13 A Well, they told us it was going to be like an
14 interrogation thing. Chief ██████████ took us for a tour. He
15 showed us the booths----

16 Q When you arrived

17 A When we arrived, yes, absolutely, the first day. Then
18 he said, it's going to be like a trial for 2 weeks just to see,
19 you know, who could accept this. He said, maybe some people,
20 it's against their religion. Some people, maybe they don't
21 accept the situation. And which was true, after 2 weeks, things
22 happened. I stayed with the interrogation team, and some other

1 guys, they went to screening. Some of the guys went to MPs, and
2 things like that.

3 Q So it kind of divided.

4 A Divided, yes.

5 Q Before you arrived, there was nothing----

6 A. Absolutely not, absolutely not.

7 Q And then at the time you were shown or given
8 familiarization, I should say, and other instructions on the
9 conduct of your specific job, were there other instructions
10 given or any changes to the procedures given to you or at least
11 instructed to you with your other coworkers?

12 A Could you elaborate on "changes"?

13 Q Yes, let me just be specific on that. At the time of
14 the shooting, at the time of allegations of detainee abuse,
15 which I'm sure people were made aware of, were there any changes
16 made to the procedures from when you were conducting the
17 procedures that you were now executing?

18 A I'm sure changes happened, but as far as visually, I
19 didn't see changes. But as far as, we can't walk with the
20 detainee too far. We have to have the military escort the
21 detainee all the way back. I'm sure changes happened, but I
22 didn't see any changes as far as----

1 Q. During the course of your involvement with
2 interrogation operations and then when the detainee was given
3 back to the MPs, did you see any physical action that would lead
4 you to question whether they were right or wrong? What I'm
5 saying is, when they're handling detainees, besides handcuffing,
6 besides leading the detainee back to his cell and besides having
7 the bag placed back on his head, did you see anything out of the
8 ordinary----

9 A Well, one time, like I mentioned in the--previous with
10 the criminal investigation, I saw that they were searching their
11 cells They got all their stuff out. I think after the
12 incident of the shooting, they were searching their cells and
13 there was a dog present in the hallway

14 Q Were you there at the time?

15 A Yeah, one time, I couldn't do anything. I just backed
16 up because I couldn't do anything when they were searching the
17 cells

18 Q So you were in the cell?

19 A Not in the cell, no, in the hallway.

20 Q You were in the hallway

21 A In the hallway, but I saw the dog present and stuff on
22 the ground They were searching the cells and they wanted to
3 make sure there was no weapon or anything.

1 Q. Was the detainee in the cell or outside the cell, that
2 you can recall?

3 A. That's a good question, because I saw the stuff on the
4 ground. I saw the dog. I didn't go inside the hallway, because
5 I was on this side, and the hallway was this way and the dog was
6 in the hallway to your right, and the cells are to the left and
7 the right. You could see the cells.

8 Q. Which part of the hard site was that? Was that on
9 Tier One A?

10 A. I think it's in the A, which is where the politicians
11 and the-----

12 Q. The security detainees

13 A. Right, the Iraqi section, the other section.

14 Q. So you had been in the hard site?

15 A. Yes, I have.

16 Q. Did you notice anything peculiar like detainees
17 without their clothes on?

18 A. That I didn't see. That I didn't see, and I hate to
19 see people naked. Until now, I don't take a shower as a naked
20 person. I have to go by myself.

21 Q. Did any interrogation ever happen in the cell, itself?

1 A. In the cell, itself? No, because the cells are so
2 tiny You can't conduct interrogations in the cell. There is
3 no way

4 Q Very confined.

5 A Yes. Because maybe sometimes, the first session would
6 be, for example, they would say, "Ask him this, ask him that."
7 Because a lot of times when I'm done with my session, the MPs
8 would say, "Could you come down and see what he wants, what he
9 needs, because we can't understand his language?" And I would
10 go and ask him what he wants. Like a couple incidents happened,
11 one of the guys, he was sick and he wasn't feeling good, and he
12 wanted a doctor. And I had to translate that, "This is how his
13 feels. Maybe he has a stomach pain or back pain," or things
14 like that.

15 Q Was it common, was it just you they were asking for,
16 or were there other translators----

17 A It happened that moment I was there. They might ask
18 me because I'm done with my session and I'm about to walk and
19 they say, "Could you please come here for a second?" Just ask
20 him what he wants." And then I'd say, "I'd be glad to." And I
21 would ask him what he wants and he would say, "I'm not feeling
22 good," things like that. Maybe the next interrogator or the
3 next linguist, he might be 2 hours later. They might--if he

1 wants something from him, the MPs, he would ask them the same
2 thing.

3 Q The night or the day, I should say, where you were
4 there observing a dog doing the searching in the cell and things
5 on the ground, was that because you were called to assist as an
6 interpreter?

7 A Oh, no, no. I think we had a session, we wanted to do
8 an interrogation and we didn't do it because the situation
9 didn't happen because of the search incident and stuff.

10 Q Why were you there to begin with?

11 A What happened is, we were the nightshift. We have to
12 do interrogation on the nightshift. We were--like 24 hours.
13 And my nightshift was--I think, starts from 10:30 all the way to
14 7 o'clock. So as we were about to go to interrogation, then
15 when we saw the scene, it didn't help. We declined to go
16 forward. We just----

17 Q So you were there to take custody--or actually, not
18 take custody, but you were there to accompany the detainee to an
19 interrogation site, but because a search was happening at that
20 time, you could not conduct your interrogation. Is that what
21 you meant to say?

22 A No, sorry, let me say this. Because usually in the
3 nighttime because of the mortars they hit us with it, we used to

1 do some of the interrogation in the building, itself, in the
2 ISO

3 Q. What's an ISO?

4 A. Isolation section, they call it isolation.

5 Q. In the hard site?

6 A In the hard site, itself, in the building, itself
7 because of the shells. There was the stairs, kind of like a
8 room, we used to sit there and do the interrogations because we
9 don't want to take the detainee outside, so we used to go there
10 [inaudible] and take him back to his cell, which is nearby.

11 Q Which is a separate area away from the cell.

12 A Right, right, it is separate. Then before you go to
13 that section, there's a door, you have to pass that door, then
14 the cells would be to your left and to your right. They're
15 subdivided according to the numbers. And we were in the
16 hallway, then we saw the dogs. We saw the things, and the
17 element didn't help. So we didn't go forward. We just stopped.

18 Q But you didn't see the detainee, himself?

19 A No, no, sir, absolutely not.

20 Q But was that the detainee you were supposed to
21 interview or interrogate that night?

1 A. Yeah, because we were supposed go to do the
2 interrogation. Then when we saw the dog, we just--they were
3 searching, so....

4 Q They were searching the cell of the detainee that you
5 were going to interrogate that night.

6 A That's a good question, it could be him, it could be
7 anybody because they were searching all the cells. So I don't
8 know what they were planning on.

9 Q Oh, I see. But typically, back to the interrogation
10 plan, are you then made aware or informed which detainee that is
11 going to be interviewed? Or do they just bring in a detainee
12 and say, "Okay, now we're going to do the interview."

13 A Usually, they tell us there is--we're going to do
14 interrogation, could be for me the first time, or could be for
15 me, for example, the case that we're working on, it's been like
16 a month and a half. But previously, it could be anybody. So I
17 didn't know exactly who we were going to--they might say he's a
18 General They might say he's this They might say he's a bomb
19 maker They give us a head start

20 Q Okay, but they don't tell you the ISN number of that
21 detainee

22 A The number, no, that has nothing to do with me

1 Q They just say, "We want to interrogate somebody that
2 has something to do with----"

3 A. Right, for example, they would say, this is--maybe
4 he's [inaudible]. Maybe he has a relation with Al Qaeda. "This
5 is what the game plan is. This is what we're looking for, his
6 friends and things like that." But as far as his number, they
7 might tell me the first name and they might tell me some of the
8 background so I will be mentally prepared what kind of person
9 I'm going to see. But as far as his prisoner number, no.

10 Q Let me go back to the interrogation plan. After you
11 conduct an interrogation, the detainee is given back to the MPs
12 so he can be returned to the cell, you mentioned.

13 A Yes

14 Q And then, you and the interrogator will then discuss--
15 you do an after action review, basically, whether the questions
16 were answered to the satisfaction of the interrogator or whether
17 something else was missing. Is that typically what happens?

18 A Usually, for example, I would say--he would say, "This
19 is what he meant, right?" I'd say, "Yeah, this is what he
20 meant." If there is another answer to the same question, I
21 might tell them. If not, that's what it is.

22 Q So you try to recall----

1 A Exactly, I try to recall what he said and things like
2 that, if I missed anything, just to be just for both sides.

3 Q How confident are you with the procedures now that you
4 have been in that operating environment now since your arrival
5 at Abu Ghraib?

6 A. Right now, it's very decent. I'm confident now
7 because everybody knows what they're supposed to do. Once we're
8 done, they let the MPs know that we're done, they will come and
9 escort the detainee back to his cell, and that's what it is.

10 Q Have you worked with Mr [REDACTED] before?

11 A Yes, as a matter of fact, from October...couple times,
12 then the last case, basically, I'm all the way with him until
13 now with him----

14 Q Because you're working on a special project.

15 A Yeah, I'm on that special project.

16 Q How many other interrogators, roughly, did you work
17 with?

18 A I would easy, five or six

19 Q Did you know who Colonel Tom Pappas was?

20 A Yes

21 Q How often did you see him?

22 A Very often

3 Q Very often?

1 A Yeah.

2 Q Indirectly?

3 A Indirectly.

4 Q You mentioned Colonel ██████████ Did you see him
5 directly all the time?

6 A I seen him. He greeted me the first time when I went
7 to Abu Ghraib, he gave me a pep talk And every now and then,
8 he used to come He used to eat chow with us and all that. I'd
9 see him more often. He used to walk a lot in the hall facility.

10 Q To check?

11 A To check, absolutely.

12 Q Did you know any medical facilities that were
13 exclusively for the detainees when they get sick? You mentioned
14 people said, "I don't feel good," and they'd call you into the
15 site and asked you to interpret what is wrong with them.

16 A Yeah, what happened is, something urgent, or "This is
17 what I think," they might call the doctor. There is a doctor
18 standby But also, I used to do in the morning, I used to go
19 spend an hour and half, about an hour and a half in the open
20 camp translating for the doctor There was certain days I am
21 supposed to go in the morning with our doctors, because it's an
22 open camp There is tents There is a lot of Iraqi detainees.
3 They used to stand in a row Everybody comes in and I will

1 explain to the doctor what is going on with this guy. This guy
2 will tell me-----

3 Q. His condition, his----

4 A Yeah, and the doctor will give the recommendation.
5 "This is what I'm going to give him, this is what happening,"
6 the dosages and all that

7 Q Is it a military doctor?

8 A Yes, it was a military doctor, yes

9 Q Was it an Army doctor?

10 A It was an Army doctor. Lately, we have, I think, Air
11 Force doctors, sir

12 Q Okay, again, have you now been advised about the
13 contents of the Geneva Convention at all? Since you mentioned
14 you were not originally aware of that, and upon your arrival,
15 your supervisor had not mentioned that to you, was that----

16 A To be honest with you, I want to be fair to all the
17 parties. They might have mentioned it, but I don't recall it.
18 They may not have mentioned it because it didn't register in my
19 mind. They might, but you know, the situation is so stressful.
20 I might have forgot about it. I apologize for that

21 Q Well, the only reason why I bring that up is because
22 you said it's reciprocal. If you were in their position, the
3 detainee's position, you would want to be treated----

1 A. Right, it's only common sense. Not only that, but
2 back in the States, you listen to news and the Geneva
3 Convention, and besides, I study the law from this country, so I
4 know what the Geneva Convention is.

5 Q Speaking of that, what is your civilian employment
6 before you were hired as a translator?

7 A. My background is accounting. I have a degree in
8 electronics. I work for Icon Office Solutions for almost 12
9 years. I'm a field technician, a senior tech. I service Ricoh,
10 Canon, Hewlett Packard product and Sharp product.

11 Q Typically automation----

12 A Automation, office, yeah, networking, printers and
13 things like that.

14 Q Okay, all right, is there anything else you want to
15 add, Mr. Israel?

16 A No, sir, but I'd be glad to--if you guys need me in
17 the future, I'd be glad to serve. And I'm happy to serve the
18 United States Army. It's a pleasure for me because they opened
19 the door. The United States gave me a home, so they made me
20 feel at home. That wasn't my original home, and I'm dedicated
21 to serve the United States in my full capacity.

22 Q I'm glad you mentioned that, Mr. [REDACTED] because I'm a
3 naturalized citizen myself, so I understand how you feel.

-

1 Okay, well, let me remind you please to not discuss
2 the contents of our interview here or the scope of our
3 investigation with your coworkers or anybody that is
4 unauthorized. I also want to advise you, please, that you will
5 be subject to recall for a re-interview and we will advise you
6 and your supervisors of when that's to occur. Up until that
7 time, please safeguard the information.

8 A Absolutely.

9 Q Do you have any----

10 A Could I ask a couple of questions?

11 Q Sure

12 A Is that going to affect my clearance situation?

13 Q You're not being suspected of anything What we're
14 trying to do, as I mentioned to you, we're trying to gather
15 facts and relevant information to the allegation of
16 mistreatment, any of this information where we could ascertain,
17 in other words, once we go through and evaluate the information
18 of whether we have the relevant information and the facts
19 associated with that So for now, sir, you are not being
20 suspected of anything We just want to gain your knowledge of
21 conditions and information associated with Abu Ghraib.

22 A My pleasure to help you, sir.

-

1 [Mr. Israel departed the interview area. The interview
2 terminated at 1114, 12 February 2004.]

3

4

FM 3-19.1 (FM 19-1)

Military Police Operations

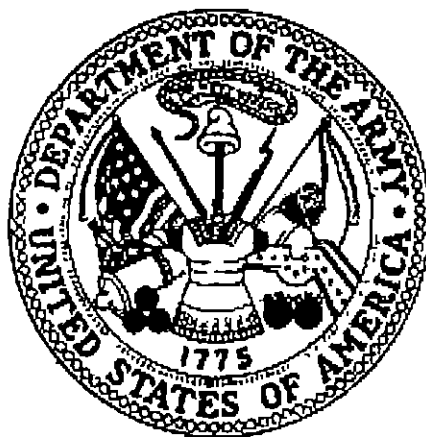

Headquarters, Department of the Army

DISTRIBUTION RESTRICTION Approved for public release, distribution is unlimited

ANNEX 92

Change 1

Headquarters
Department of the Army
Washington, DC, 31 January 2002

Military Police Operations

1 Change FM 3-19 1, 22 March 2001 as follows

Remove Old Pages

1-7 and 1-8

Glossary-5 through Glossary-16

Insert New Pages

1-7 through 1-19

Glossary-5 through Glossary-16

2 A bar (|) marks new or changed material

3 File this transmittal sheet in front of the publication

DISTRIBUTION RESTRICTION Approved for public release, distribution is unlimited

By Order of the Secretary of the Army

ERIC K SHINSEKI
General, United States Army
Chief of Staff

Official

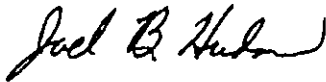

JOEL B HUDSON
Administrative Assistant to the
Secretary of the Army
0203505

DISTRIBUTION

Active Army, Army National Guard, and US Army Reserve To be distributed in accordance with the initial distribution number 111046, requirements for FM 3-19 1

Military Police Operations

Contents

	Page
PREFACE	IV
Chapter 1 INTRODUCTION	1-1
Overview	1-1
Operational Framework	1-3
Battlefield Organization	1-4
Types of Military Police Units	1-7
Joint, Multinational, and Interagency Operations	1-7
Chapter 2 BATTLE COMMAND	2-1
Overview	2-1
Battlefield Visualization	2-1
Commander's Intent	2-2
Concept of Operations	2-2
Command and Control Relationships	2-2
Support Relationships	2-3
Staff Relationships	2-3
Chapter 3 THE THREAT	3-1
Overview	3-1
Rear-Area and Sustainment Operations	3-1
Reception, Staging, Onward Movement, and Integration Operations	3-2
Threat Levels	3-3
Threat Priorities	3-4
Threat Location	3-5
Countering the Threat	3-7
Chapter 4 MILITARY POLICE FUNCTIONS	4-1
Overview	4-1
Maneuver and Mobility Support	4-2
Area Security	4-6
Internment and Resettlement	4-9
Law and Order	4-10
Police Intelligence Operations	4-13

Distribution Restriction: Approved for public release, distribution is unlimited

*This publication supersedes FM 19-1, 23 May 1988

	Page
Chapter 5	MILITARY POLICE SUPPORT TO ECHELONS ABOVE CORPS 5-1
	Overview 5-1
	Military Police Support 5-2
Chapter 6	MILITARY POLICE SUPPORT TO CORPS 6-1
	Overview 6-1
	The Military Police Brigade (Combat Support) 6-1
	Command and Control 6-3
	Employment 6-3
Chapter 7	MILITARY POLICE SUPPORT TO DIVISION 7-1
	Overview 7-1
	Division Military Police Company 7-2
	Command and Control 7-2
	Military Police Employment 7-3
Chapter 8	SEPARATE BRIGADES AND INITIAL/INTERIM BRIGADE COMBAT TEAMS . 8-1
	Overview 8-1
	Support to Separate Brigades 8-1
	Support to the Initial/Interim Brigade Combat Team 8-2
Chapter 9	THE UNITED STATES ARMY CRIMINAL INVESTIGATION COMMAND 9-1
	Overview 9-1
	Command and Control 9-2
	Wartime Support 9-2
	Organization 9-4
	Employment 9-8
Chapter 10	OFFENSIVE AND DEFENSIVE OPERATIONS 10-1
	Overview 10-1
	Support to Offensive Operations 10-1
	Support to Defensive Operations 10-3
Chapter 11	STABILITY AND SUPPORT OPERATIONS 11-1
	Overview 11-1
	Force Suitability 11-2
	Stability and Support 11-3
	Organizations and Capabilities 11-14
Chapter 12	FORCE PROTECTION 12-1
	Overview 12-1
	Support to Force Protection 12-1
Appendix A	METRIC CONVERSION CHART A-1
Appendix B	DOCTRINE AND TRAINING LITERATURE B-1
	Doctrine B-1
	Tactics B-2
	Techniques B-2
	Procedures B-2

	Page
Appendix C BATTLEFIELD WORKLOAD ANALYSIS	C-1
Appendix D AUTOMATED INFORMATION SYSTEMS IN SUPPORT OF BATTLE COMMAND	D-1
Army Information Systems	D-1
Military Police Automated Systems	D-4
Appendix E POLICE INFORMATION ASSESSMENT PROCESS	E-1
Implementation	E-1
Sample Scenario	E-6
Glossary	Glossary-1
Bibliography	Bibliography-1
Index	Index-1

Preface

The Military Police (MP) Corps supports the commander across the full spectrum of military operations. This manual is the foundation for all MP doctrine as it relates to this support. It communicates to all levels of leadership and staffs how the MP provide a flexible and lethal force capable of operating across this full spectrum. As the keystone manual, it identifies what the MP train on and how their forces are organized and equipped in support of all Army echelons. Additionally, this manual provides guidance that can be used by United States (US) Army service schools, students, sister services, and federal agencies.

This manual is based on the purpose, organization, responsibilities, and goals of the US Army as set forth in Field Manuals (FMs) 100-1 and 3-0, as well as corps, division, and brigade manuals. Additionally, this manual is fully compatible with current joint, multinational, and interagency doctrine.

Appendix A contains a metric conversion chart.

The proponent of this publication is HQ TRADOC. Send comments and recommendations on Department of the Army (DA) Form 2028 directly to Commandant, US Army Military Police School (USAMPS), ATTN: ATSJ-MP-TD, 401 Engineer Loop, Suite 2060, Fort Leonard Wood, Missouri 65473-8926.

Unless this publication states otherwise, masculine nouns or pronouns do not refer exclusively to men.

Chapter 1

Introduction

The MP Corps has a strong history evolving over the past five decades. We, as a corps, continue to transform our organizations and doctrine as we have in the past to support the Army in the active defense of the 1970s, the AirLand battle of the 1980s, and now the force-projection doctrine of the 1990s. Our five MP functions clearly articulate the diverse role the MP play across the full spectrum of military operations. We cannot bask in our successes, nor reflect or celebrate. Our charter is to continue our legacy of stellar performance and strive to perfect it.

BG Donald J. Ryder

When the Army developed the Active Defense strategy in 1976, the US was facing the Cold War scenario of central Europe. Military strategy and doctrine were related to a single, focused threat that revolved around the countries in the Warsaw Pact. We were an outnumbered and technically inferior force facing an armor-dominated European battlefield. The MP Corps supported the Active Defense strategy by tailoring its forces to meet the threat. In 1982, when the AirLand Battle strategy was developed, US forces were still outnumbered, but were no longer technically inferior. Still threat-based and focused on a central European conflict, the AirLand Battle strategy used a relatively fixed framework suited to the echeloned attack of soviet-style forces. It delineated and clarified the levels of war, emphasized closed, concerted operations of airpower and ground forces, balanced the offense and the defense, and highlighted the synchronization of close, deep, and rear operations. MP doctrine kept pace with the Army's AirLand Battle strategy by supporting the battlefield commander through four basic missions—battlefield circulation and control, area security (AS), enemy prisoner of war (EPW), and law and order (L&O).

OVERVIEW

1-1 In October 1983, MP capabilities in the AirLand Battle strategy were tested during operation Urgent Fury in Grenada. The MP performed missions that ranged from assisting the infantry in building-clearance operations to assisting Caribbean peacekeeping forces in restoring L&O. These actions secured the MP's place in the combat-support (CS) role, demonstrating the professional knowledge and flexibility necessary for rapid transition from combat to CS to peacetime missions. The changing battlefield conditions of operation Urgent Fury set the stage for the demand of MP units today.

1-2 Evolving simultaneously with the changing definition of the modern battlefield, MP performance in Operations Hawkeye, Just Cause, and Desert Shield/Storm galvanized their ability to perform at any point along the operational continuum. With the publication of FM 100-5 in 1993, the Army adopted the doctrine of full-dimensional operations, relying on the art of battle command to apply those principles and to shift the focus from AirLand Battle to force-projection doctrine. This new doctrine was based on recent combat experience in a multipolar world with new technological advances. Already trained and expected to perform in this new strategy, MP support was already in place and fully operational. The MP continued to perform their basic battlefield missions and to refine their capabilities while supporting the battlefield commander as he deployed to contingency operations throughout the world.

1-3 In 1996, the MP Corps went through a doctrinal review process to determine if it was properly articulating its multiple performance capabilities in support of US forces deployed worldwide (see Appendix B). The review process identified the need to restructure and expand the EPW mission to include handling US military prisoners and all dislocated civilians. This new emphasis transformed the EPW mission into the internment and resettlement (I/R) function. The review process also identified the need to shift from missions to functions. In the past, the four battlefield missions adequately described MP capabilities in a mature theater against a predictable, echeloned threat. However, that landscape is no longer valid. Accordingly, the four MP battlefield missions have become the following five MP functions:

- Maneuver and mobility support (MMS)
- AS
- L&O
- I/R
- Police intelligence operations (PIO)

1-4 These new MP functions are shaped by the following factors:

- The application of stability and support operations where the integration of joint, multinational, and interagency capabilities are common occurrence
- The lack of traditional linear battlefields, requiring theater commanders in chief (CINCs) to request forces that meet a specific function to accomplish operational requirements
- The impact of asymmetric threats (such as drug traffickers and terrorist factions) and the effects of man-made and natural disasters
- The impact of advances in information and communication technologies and specifically in understanding the increased vulnerabilities presented by these technologies

1-5 Articulating MP capabilities along functional lines benefits the MP and the Army echelon commander as well as the combatant commander. Since there is a multinational, interagency, and sister-service overlap of security services, the importance of including MP leaders and staffs early in the operational planning process cannot be overemphasized. This means before units are designated, unit boundaries are drawn, and unit missions are assigned. Early involvement ensures the proper development of common

security responsibilities, communication and connectivity, liaisons, processes, and the rules of interaction between all forces. The ultimate goal should be the optimal, phased employment of MP forces in support of a commander's operational plan. MP functions not only reflect and capture current capabilities, they define the MP Corps in the twenty-first century.

1-6 As the Army reshapes and focuses its resources on transformation, Force XXI, and other redesign efforts, the MP Corps stands proud and ready to support this progress and reiterate its commitment to assist, protect, and defend.

OPERATIONAL FRAMEWORK

1-7 The operational framework consists of the arrangement of friendly forces and resources in time, space, and purpose with respect to each other, the enemy, or the situation (see Figure 1-1). The operational framework for Army forces (ARFOR) rests within the combatant commander's theater organization. Each combatant commander has an assigned geographical area of responsibility (AOR), also called a theater, within which he has the authority to plan and conduct operations. Within the theater, joint-force commanders at all levels may establish subordinate operational areas such as areas of operation (AOs), joint-operations areas (JOAs) and joint rear areas.

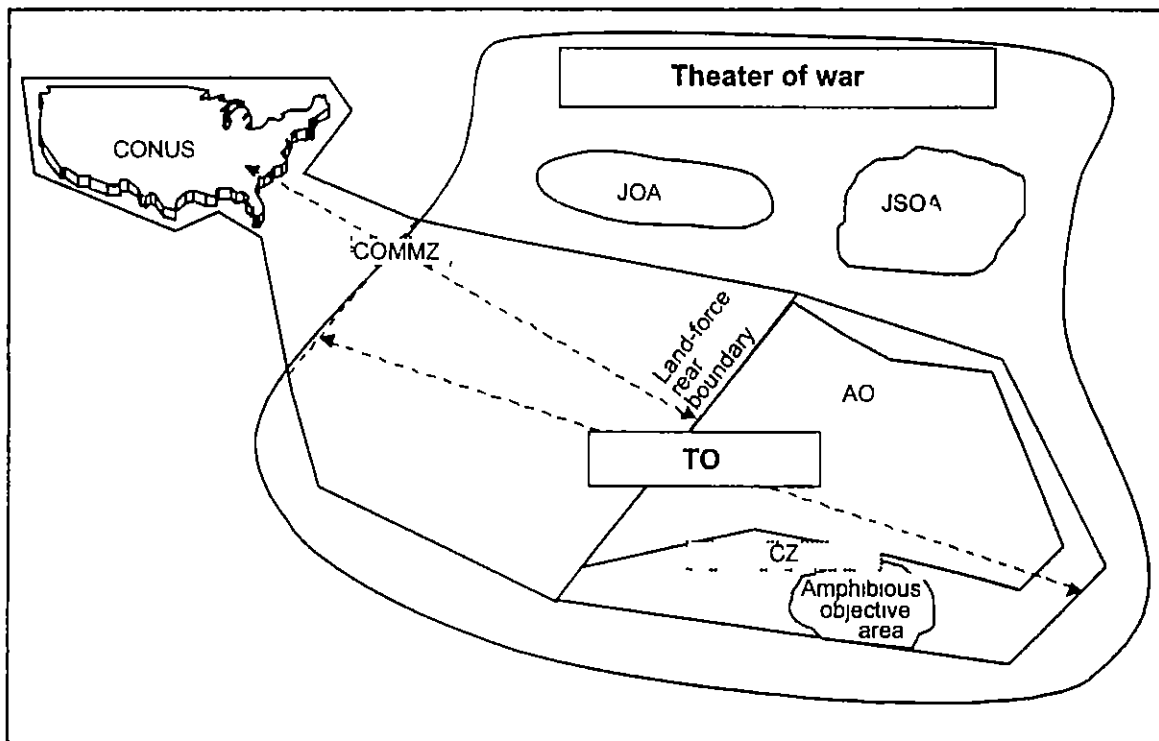

Figure 1-1 Operational Framework

(JRAs) The JRAs facilitate the protection and operation of bases, installations, and forces that support combat operations. When warranted, combatant commanders may designate theaters of war, theaters of operations (TOs), combat zones (CZs), and communications zones (COMMZs).

1-8 A theater of war is that area of air, land, or water that is, or may become, directly involved in the conduct of the war. A theater of war may contain more than one TO. It does not normally encompass the geographic combatant commander's entire AOR. A TO is a subarea (defined by a geographic combatant commander) within a theater of war in which specific combat operations are conducted or supported.

1-9 A CZ is the area required by combat forces for conducting operations. It normally extends forward from the land force's rear boundary. The COMMZ is the rear part of the TO (behind but contiguous to the CZ) that contains the lines of communication (LOC) and provides supply and evacuation support. Other agencies required for the immediate support and maintenance of field forces may also be located in the COMMZ. The COMMZ spans back to the continental US (CONUS) base, to a supporting combatant commander's AOR, or both.

1-10 An AO is an operational area defined by the joint-force commander for land and naval forces. An AO does not typically encompass the entire operational area of the joint-force command (JFC), but it should be large enough for component commanders to accomplish their mission and protect their forces. Army commanders use control measures to describe AOs and to design them to fit the situation and take advantage of the joint force's capabilities. Commanders typically subdivide the assigned AO by assigning subordinate-unit areas. These subordinate-unit areas may be contiguous or noncontiguous (see Figure 1-2). When friendly forces are contiguous, a boundary separates them. When friendly forces are noncontiguous, the concept of operations links the force's elements, but the AOs do not share a boundary. The intervening area between noncontiguous AOs remains the responsibility of the higher headquarters.

BATTLEFIELD ORGANIZATION

1-11 Battlefield organization is the arrangement of forces according to purpose, time, and space to accomplish a mission. Battlefield organization has both a purpose- and spatial-based framework. The purpose-based framework centers on decisive, shaping, and sustaining (DSS) operations. Purpose unifies all elements of the battlefield organization by providing the common focus for all actions. However, forces act in time and space to accomplish a purpose. The spatial-based framework includes close, deep, and rear areas. Despite the increasing nonlinear nature of operations, there may be situations where commanders describe DSS operations in spatial terms. Typically, linear operations involve conventional combat and concentrated maneuver forces. Ground forces share boundaries and orient against a similarly organized enemy force. In such situations, commanders direct and focus simultaneous DSS operations in deep, close, and rear areas, respectively (see FM 3-0).

1-12 The MP battlefield organization supports every Army echelon, from the Army service component command (ASCC) and the theater-support command

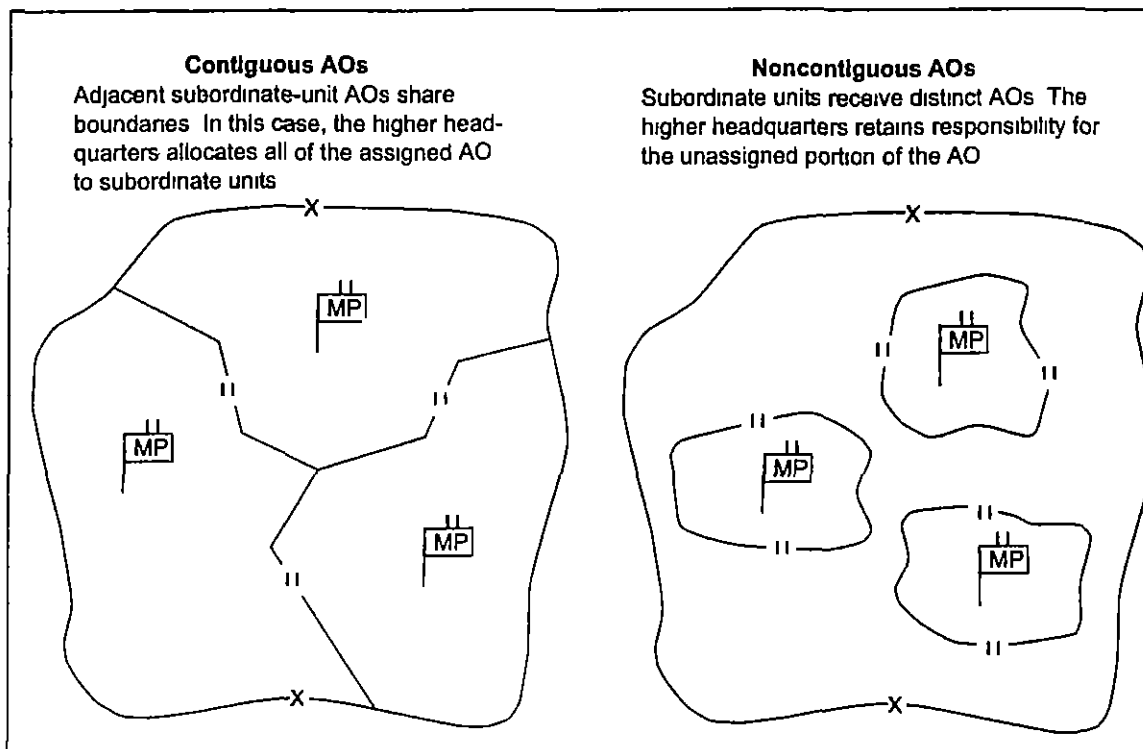

Figure 1-2 Contiguous and Noncontiguous AOs

(TSC) to the maneuver brigade. Regardless of the battlefield organization (purpose or spatial based), MP support to the Army commander is based on available resources and mission, enemy, terrain, troops, time available, and civilian considerations (METT-TC).

1-13 MP support throughout the theater of war may include MP units in the JOA and in the TO. If the combatant commander designates a COMMZ and a CZ within his TO, MP support will come from the established MP modified table of organization and equipment (MTOE) at the subordinate-command echelon. MP support to the JOA is also provided based on METT-TC and available MP assets. Typical MP support may include an I/R brigade liaison detachment (BLD), MP brigades and battalions, a division MP company, a military-working-dog (MWD) team, an L&O team, and a customs team. Figure 1-3, page 1-6, depicts a typical MP organization throughout the TO. In the COMMZ, Figure 1-3 depicts the different types of MP units that are assigned to echelons above corps (EAC) (the ASCC or the TSC). In the CZ, Figure 1-3 depicts the different types of MP units that are assigned to corps, division, and the separate brigades.

SUPPORT IN THE COMMZ

1-14 MP support in the COMMZ is provided by an array of multifunctional MP units. The following MP units provide MP support to EAC:

- The MP brigade (I/R). The MP brigade (I/R) may augment the ASCC or the TSC during wartime. Its mission is to provide command, staff

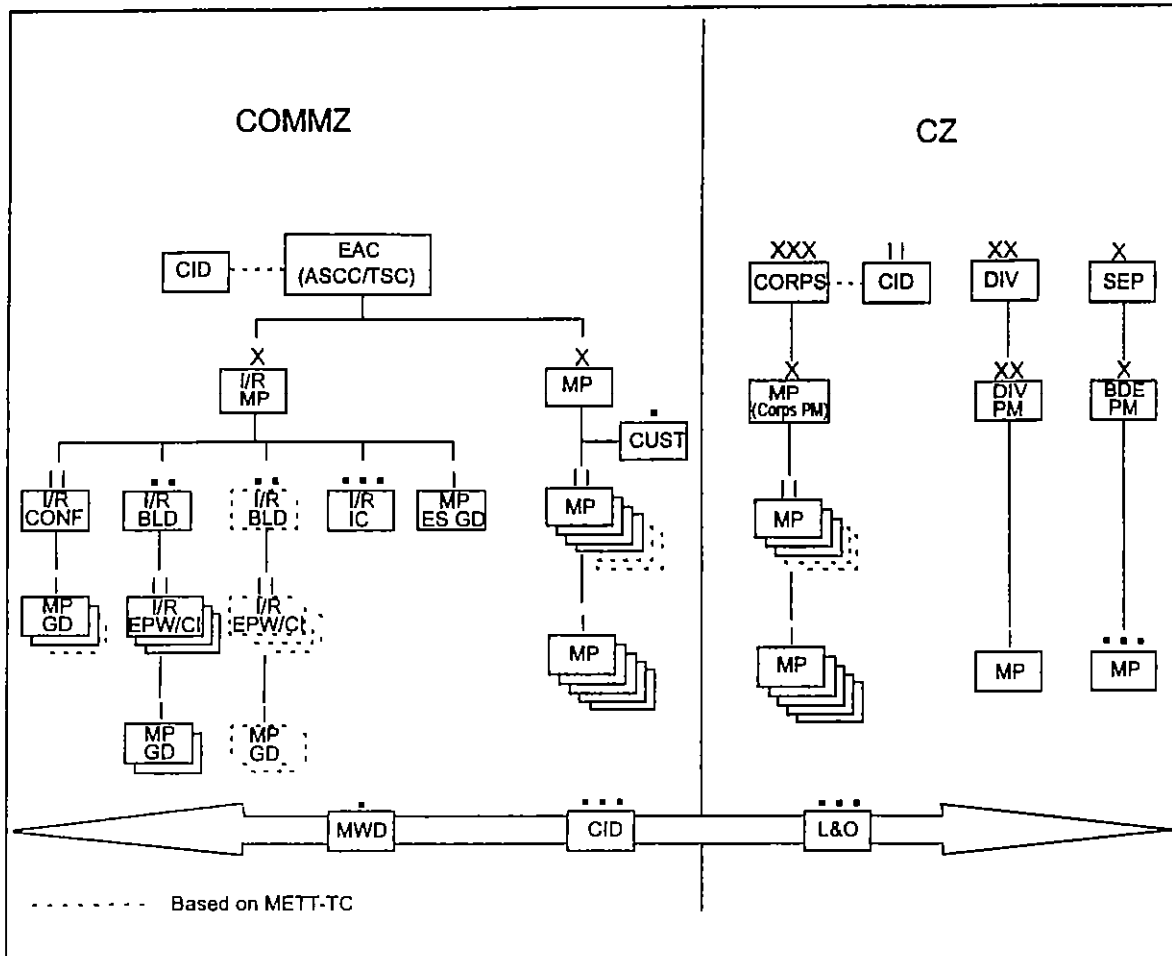

Figure 1-3 MP Structure in the TO

planning, and supervision of I/R operations. This includes coordination with joint and host-nation (HN) agencies, civilian police authority, nongovernmental organizations (NGOs), and US federal agencies.

- The MP brigade (CS) The MP brigade (CS) is assigned to the ASCC or the TSC during wartime (based on METT-TC). The MP brigade (CS) is capable of performing all five MP functions.
- The Criminal Investigation Division (CID) group The CID group is a stovepipe organization that reports directly to the Commander, US Army Criminal Investigation Command (USACIDC). The CID group provides support to the ASCC and subordinate commands (TSC, corps, or division). See Chapter 9 for further discussion of CID support.

1-15 MP support to other EAC subordinate commands is performed only if MP resources are available. See Chapter 5 for further discussion of MP support to EAC.

SUPPORT IN THE CZ

1-16 MP support is provided in the CZ to each corps, division, and brigade (separate teams or initial/interim brigade combat teams [IBCTs]). An MP brigade (CS) is assigned to each corps, and the MP brigade commander is the corps's provost marshal (PM). A PM and his section, along with an organic division MP company, are assigned to each division. A PM cell and an MP platoon are organic to a separate brigade. A two-person PM cell is organic to the IBCT. The MP units assigned to corps, divisions, and separate brigades are capable of performing all five MP functions. They provide combat, CS, and combat-service-support (CSS) operations within their command's AO.

TYPES OF MILITARY POLICE UNITS

1-17 Most MP units supporting a TO and a JOA are capable of performing all five MP functions. However, the functions must be prioritized based on METT-TC and the availability of MP assets. Current MP structures are designed and tailored to better support the level of command deployed. For example, at the division level, division MP companies are organized as light, heavy, airborne, or air assault and are organic to their respective divisions. The EAC and corps MP brigades and battalions are equally designed to command and control a force mix of up to six battalions or companies. An MP escort-guard and guard company are designed to transport, guard, and provide security to EPWs, civilian internees (CIs), or dislocated civilians. The MP escort-guard company is assigned to the MP brigade (I/R), and the MP guard company is assigned to the MP battalion (I/R).

1-18 MP units can also be tailored and augmented to accomplish multiple, diverse, or specific missions. Customs, L&O, and MWD teams are examples of MP capabilities and flexible responses to a combatant commander's operational requirements. (See Table 1-1, pages 1-9 through 1-19, for a more complete description of MP units. See FM 19-10 and Army Regulation (AR) 190-12 for further information.) The battlefield workload analysis (BWA) is a tool used to determine the number of MP units required to perform some of these multiple missions (see Appendix C).

JOINT, MULTINATIONAL, AND INTERAGENCY OPERATIONS

1-19 In today's environment, the Army will rarely operate or fight alone. The high probability that the Army will operate in concert with its sister services, in an alliance with the forces of foreign nations, or in support of United Nations (UN) operations (when it is committed) is fully reflected in joint doctrine. In such operations, protecting LOC, key facilities, and command and control (C²) centers will be a shared responsibility. Under this framework, MP units can expect to share the AO with joint, combined, multinational, or interagency resources. MP forces must be prepared to conduct a number of full-spectrum operations with a variety of government and nongovernmental agencies, other services, allied nations, and international agencies.

1-20 Corps and division commanders and staffs must plan (in advance) the transition from a single-service headquarters with joint representation to a joint headquarters capable of functioning as a joint task force (JTF).

headquarters. When tasked to form a JTF headquarters, the corps or division must ensure that all of the staff sections and agencies have joint representation (see FMs 100-15 and 71-100). To this end, MP planners must ensure that the JTF is augmented with the appropriate MP forces and with the appropriate echeloned C².

1-21 Regardless of the force mix, the MP provide the force with unparalleled, multifunctional capabilities. Among these capabilities is the MP's ability to generate firepower or to handle populations such as EPWs/CIs, dislocated civilians, and refugees. Additionally, MP expertise in investigations and law enforcement enhances the capabilities of other joint, multinational, and interagency police and security forces.

1-22 MP security plans must reflect the joint synergy derived from combining the multiple and diverse capabilities of all participants. To capitalize upon that synergy, MP leaders must keep an open line of communication and coordination to offset the challenges presented by interoperability. Some of these interoperability challenges include—

- Differing political objectives
- Differing capabilities
- Cultural/language differences
- Legal and policy constraints
- Media impacts
- Compromise of sensitive processes, procedures, and equipment
- C²
- Communications (digital- and analog-equipment differences)

1-23 MP plans must also accommodate differences in planning capabilities, as well as differences in doctrine, training, and equipment. The intent is to match security missions with force capabilities. MP leaders must understand that operations will often involve multinational teams. While US forces routinely task-organize, this may be more difficult to accomplish with some multinational security forces. This kind of orchestration requires employing standardized procedures, communications, equipment, and liaison within the constraints of operations security (OPSEC).

1-24 Coordination is the key to mission accomplishment in multinational and interagency operations. A military coordination center or a civil-military operations center (CMOC) may meet this coordination requirement. The CMOC provides access for nonmilitary agencies desiring military (to include MP/CID) assistance and coordination. These nonmilitary agencies may include—

- Government organizations (GOs)
- NGOs
- International organizations (IOs)
- International humanitarian organizations (IHOs)
- HN authorities and agencies

1-25 The introduction of US Army MP forces in any joint, multinational, or interagency operation is based on METT-TC and the capabilities they bring to the operation. Effective integration of MP forces with other security forces reduces redundant functions, clarifies responsibilities, and conserves resources.

Table 1-1. Unit Descriptions

MP Unit	Mission	Action Elements	Support Role	Capabilities (Include But Are Not Limited to [See TOEs for Details])	Augmentation Needed for Mission Accomplishment
DIVISION MP UNITS					
MP Company (Airborne Division)	Perform the 5 MP functions	A PM cell and 4 platoons Each platoon has 3 squads and each squad has 2 three-man teams Total 24 three-man teams	1 platoon deploys with each division brigade and provides DS during the assault phase Then platoons revert to GS	During the assault phase, 6 mounted mobile or fixed-position teams deploy to provide DS for each brigade and 6 teams deploy to provide GS near the division main CP OR after the assault phase, 1 division EPW collection point (6 teams) and 18 mounted mobile patrols or fixed-position teams provide GS OR 24 mounted, mobile or fixed-position teams are used in any combination	The division band to provide close-in security for the division CP or to guard EPWs AND the corps CS MP to conduct combat operations within the division rear and provide sustained MMS, area security, special operations support, and escort for evacuating EPWs/CIs between division collection points and to the corps holding area AND the corps L&O MP and CID to conduct sustained L&O operations and criminal investigations AND division/corps transportation assets for evacuation of EPWs NOTE: Both heavy division companies require corps CS MP augmentation for each forward support platoon (1 corps MP squad per forward support platoon).
MP Company (Light Infantry Division)	Perform the 5 MP functions	A PM cell and 3 platoons Each platoon has 3 squads and each squad has 2 three-man teams Total 18 three-man teams	Provide GS for all units in the AO	Provide screening security for the division main CP (6 teams), the division EPW collection point (6 teams) and 6 mounted mobile or fixed-position teams	
MP Company (Heavy Division) *19333F000	Perform the 5 MP functions	A PM cell and 2 division support platoons. Each platoon has 3 squads and each squad has a squad leader and 3 three-man teams AND 3 forward support platoons. Each platoon has 2 squads and each squad has a squad leader and 3 three-man teams Total 36 three-man teams	2 platoons provide GS and 3 platoons provide DS	Provide screening security for the division main CP (6 teams), the division EPW collection point (6 teams) and 6 mounted, mobile or fixed-position teams AND EITHER 3 DS platoons providing their brigade with either 1 forward EPW collection point (3 teams) and 3 mounted, mobile or fixed-position teams or 6 teams in any combination OR 18 mounted, mobile or fixed-position teams are used in any combination	
MP Company (Heavy Division) *19333L000	Perform the 5 MP functions	A PM cell and 5 platoons. Each platoon has 2 squads and each squad has 3 three-man teams Total 36 three-man teams	3 platoons provide GS and 3 platoons provide DS	Provide screening security for the division main CP (6 teams), the division EPW collection point (6 teams), and 6 mounted, mobile or fixed-position teams AND EITHER 3 DS platoons providing their brigade with either 1 forward EPW collection point (3 teams) and 3 mounted, mobile or fixed-position teams or 6 teams in any combination OR 18 mounted, mobile or fixed-position teams are used in any combination	

Table 1-1 Unit Descriptions (continued)

MP Unit	Mission	Action Elements	Support Role	Capabilities (Include But Are Not Limited to [See TOEs for Details])	Augmentation Needed for Mission Accomplishment (See augmentation needs on previous page)
MP Company (Air Assault Division)	Perform the 5 MP functions	A PM cell and 4 platoons. Each platoon has 3 squads and each squad has 2 three-man teams. Total: 24 three-man teams	Provide GS for all units in the AO	24 mounted, mobile or fixed-position teams are used in any combination	(See augmentation needs on previous page)
MP COMBAT SUPPORT UNITS					
HHC MP Brigade	Provide C2 and coordinate the combat, CS and CSS of all MP elements assigned or attached	Command and staff elements and long-range planning section	Provide command, control, planning, and supervision for up to 6 MP battalions and other assigned or attached subordinate HQ	Provide continuous command, control, coordination, planning and supervision for subordinate units	None
HHD MP Battalion (Combat Support)	Provide C2 and coordinate the combat CS and CSS of all MP elements assigned or attached	Command and staff elements plus a support element	Provide command control, planning, and supervision for up to 6 MP companies and other assigned or attached subordinate HQ	Provide continuous command, control, coordination, planning and supervision for subordinate units	None
MP Company (Combat Support)	Perform the 5 MP functions	4 platoons with 3 squads. Each squad has a squad leader and 3 three-man teams. Total: 36 three man teams	Provide GS for all units in the AO	Provide security for a unified or combined HQ or higher HQ or 1 main CP and 1 tactical CP OR operate 1 EPW holding area (9 teams) and 27 mounted, mobile or fixed-position teams for use in any combination	Corps band assets to guard EPWs AND corps transportation for evacuation of EPWs AND external MP to escort EPWs
MP Company (Combat Support)	Perform the 5 MP functions	4 platoons with 3 squads. Each squad has a squad leader and 3 three-man teams. Total: 36 three-man teams	Provide GS for all units in the AO	Provide security for a unified or combined HQ or higher HQ or 1 main CP and 1 tactical CP OR operate 1 EPW holding area (9 teams) and 27 mounted, mobile or fixed-position teams for use in any combination	Corps band assets to guard EPWs AND corps transportation for evacuation of EPWs AND external MP to escort EPWs
MP Company Arctic Support Augmentation Detachment	Augment MP units when operating in an arctic environment	1 mechanic (63B10)	Provide mobility support to MP units	Provide support as designated by the commander	None
MP Detachment (C2)	Provide command and administrative personnel for MP law enforcement teams	19503LA has a platoon HQS, 3 individuals. 19503LD has a commander and support personnel. 8 individuals	Provide L&O. 19503LA provides platoon-level C2. 19503LD provides company-level command, control and support	Commands and controls law enforcement teams, investigations teams MWD teams and physical-security teams	None

Table 1-1. Unit Descriptions (continued)

MP Unit	Mission	Action Elements	Support Role	Capabilities (Include But Are Not Limited to [See TOEs for Details])	Augmentation Needed for Mission Accomplishment
MP Detachment (Old Guard)	Perform the 5 MP functions	4 squads Each squad has 3 three-man teams Total 12 teams	Support the HHC old guard battalion	Provide support as directed by the commander	None
MP LAW AND ORDER (L&O) UNITS					
MP HQ Team	Provide C2 personnel administration, and logistical support to attached L&O augmentation teams	Commander and support personnel	Provide L&O	Provide C2, personnel administration, and logistical support to attached L&O augmentation teams	None
MP Operations Team	Provide mission supervision and technical supervision required to support the L&O mission	L&O operations officer and operations staff	Provide L&O	Provide overall mission supervision, planning, employment, and coordination of support. Provide technical supervision and administrative support of MPI TAI, and force protection MP Provide an evidence custodian/police intelligence NCO to be responsible for confiscated property used in criminal offenses and to receive and collect the initial analysis of criminal/operational information/intelligence	None
MP Desk or Record Team	Serve as the primary control point for L&O-related incidents and operations initiated by MP patrols	2 three-man teams	Provide L&O	Receive/record complaints, dispatch investigative persons, maintain control of offenders/detained, prepare reports and provide criminal data to the police intelligence NCO for analysis	None
MP Traffic Accident Investigations Team	Provide the technical capability to investigate traffic accidents	1 two- or three-man team 19517AD00 has 1 two-man team 19523LE00 has 1 three-man team	Provide L&O	Augment MP capabilities to enforce MSR regulations, man checkpoints, roadblocks, and dismount points, patrol traffic areas, and perform traffic escort duties	The 19517AD00 accident investigation team is dependent on the supported unit for transportation
MP Investigation Team	Provide the technical capability to investigate criminal incidents and conduct surveillance operations	One, two or three-man teams 19517AE has 1 two-man team 19533LA has 1 one-man team 19533LB has 1 one-man team 19533LC has 1 three-man team	Provide L&O	Investigate criminal incidents, conduct surveillance, work with HN military and civilian police, and collect criminal and operational intelligence 19533LA00 provides supervision for the teams 19533LB00 provides investigative support for populations of not less than 700 troops 19533LC00 provides investigative support for populations of not less than 2,100 troops	Dependent on the supported unit for transportation

Table 1-1 Unit Descriptions (continued)

MP Unit	Mission	Action Elements	Support Role	Capabilities (Include But Are Not Limited to [See TOEs for Details])	Augmentation Needed for Mission Accomplishment
MP Force Protection and Physical Security Teams	Provide the expertise and technical capability to assist units in safeguarding personnel equipment and facilities	One two or three-man teams 19517AF has 1 two-man team 19593LA has 1 three-man team 19593LB has 1 one-man team	Provide L&O and area security	Conduct vulnerability assessments and identify and prioritize critical facilities and key terrain within the AO Identify mission-essential activities that are vulnerable to criminal acts or disruptive activities Ensure that activities are inspected to determine if safeguards are adequate Assist base/base cluster commanders with the development of internal defense plans	The 19517AF is dependent on the 19517AB operations team for transportation
MP Detachment (Patrol Supervision Team)	Provide supervision for 3 MP teams	1 MP NCO	Provide L&O	Plan direct, and supervise the employment of assigned or attached MP teams	Dependent on the supported unit for transportation
MP Detachment (Motor and Dismounted Patrol Team)	Perform L&O operations	1 three-man team	Provide L&O	Protect designated personnel or facilities Perform route and area reconnaissance enforce MSR regulations provide refugee and straggler control and disseminate information Perform peacekeeping operations to maintain surveillance over an area observe activities, and report findings Preserve or establish L&O Apprehend absentees or deserters (US military personnel) in conjunction with civil law enforcement agencies	The dismounted patrol team is dependent on the supported unit for transportation when required
MP Detachment (Registration Team)	Perform vehicle and firearm registration	1 three-man team	Provide L&O	Service up to 10,000 personnel for registration of individuals, vehicles, and firearms on a closed post or area Issue credentials prescribing limits of circulation and privileges Process up to 50 personnel daily for fingerprints and photography services	Dependent on the supported unit for transportation
Senior Military Customs Inspector Supervisor	Perform technical supervision, staff planning and coordination for customs inspection teams	1 MP NCO	Provide L&O	Supervise two senior military customs teams to ensure that personnel, equipment, and material meet customs, immigration, Department of Agriculture, and other federal agency requirements for units and personnel redeploying to the US	None

Table 1-1 Unit Descriptions (continued)

MP Unit	Mission	Action Elements	Support Role	Capabilities (Include But Are Not Limited to [See TOEs for Details])	Augmentation Needed for Mission Accomplishment
Senior Military Customs Inspection Team	Conduct customs inspections and train and supervise redeploying unit personnel to augment US customs inspectors	1 five man team	Provide L&O	Conduct inspections and advise redeploying units Train selected individuals from the redeploying unit to augment US customs efforts NOTE One team supports one port of embarkation	The redeploying unit undergoing customs inspection, to augment US Customs efforts The number of personnel is proportional to the size of the unit
MILITARY WORKING DOG (MWD) UNITS					
MWD Kennel Master Team	Supervise MWD teams	One- or two-man team 19537AA has 1 two-man team 19583LG has 1 one-man team	Provide L&O area security and I/R operations support	Supervise plan and coordinate MWD operations and support requirements Provide MWD handler/canine proficiency certification	None
MWD Explosive Narcotics and Patrol Team	Detect explosives and controlled substances and search for defect and control personnel in support of crime scene searches Provide personal protection MOUT health and welfare inspections, and I/R and customs operations	One-man/one-dog team The 19537A000-series TOEs have 3 teams each The 19583L000-series TOEs have 1 team each	Provide L&O area security, and I/R support	The 19537A-series dog teams are capable of providing a 24-hour explosive narcotics, and tracking handler/dog requirement or three concurrent short-duration missions each requiring 1 handler/dog team The duration of the missions will vary based on the climate the environment, and the individual dog's ability The 19583L-series dog teams provide short- duration missions based on the dog's ability Explosive and narcotics teams provide MWD patrol support when not employed with explosive and narcotics detection	None
MILITARY POLICE INTERNMENT/RESETTLEMENT (I/R) UNITS					
MP Command (I/R)	Provide command control, staff planning, and supervision of I/R operations performed by all assigned or attached elements	Command and staff elements	Provide I/R operations support	Provide command, control, and staff planning for 2 or more MP brigades	MP I/RIC AND MP EPW evacuation detachment

Table 1-1 Unit Descriptions (continued)

MP Unit	Mission	Action Elements	Support Role	Capabilities (Include But Are Not Limited to [See TOEs for Details])	Augmentation Needed for Mission Accomplishment
MP Brigade (I/R)	Provide command and control and staff planning for I/R operations performed by all assigned or attached MP elements	Command and staff elements	Provide I/R operations support	Provide command, control, and staff planning for 2 to 7 MP I/R battalions or up to 21 MP I/R battalions (BLDs) Plan and provide staff supervision of I/R collection and evacuation operations Coordinate with HN military territorial organizations and civilian police authorities nongovernment organizations, private volunteer organizations, and US federal agencies on I/R matters Provide coordination and support for out-of-theater evacuation of EPWs, if required Support posthostilities operations	MP I/R AND MP EPW evacuation detachment AND MP I/R BLD (TOE 19453LD00) NOTE. The BLD expands the staff planning and coordination capabilities on a ratio of 1 BLD to 3 MP I/R battalions
MP Battalion (I/R)	Provide command staff planning, administration and logistical support for the operation of an I/R facility	Command and staff elements	Provide I/R operations support	Operate an internment facility for either EPWs/CIs or DCs or a confinement facility for US prisoners (Never more than one category at the same time)	MP detachment (I/R) (EPW/Ci) for EPW/Ci/DC internment missions AND MP detachment (I/R) (confinement) for US prisoner confinement missions AND MP company (EG) for security of the evacuation and/or movement of US prisoners or EPWs/CIs/DCs AND MP company (guard) for prisoner guard services AND Corps/EAC transportation assets for movement of EPWs/CIs/DCs

Table 1-1 Unit Descriptions (continued)

MP Unit	Mission	Action Elements	Support Role	Capabilities (Include But Are Not Limited to [See TOEs for Details])	Augmentation Needed for Mission Accomplishment
MP Detachment (I/R) (EPW/CI)	Augment the MP battalion (I/R) to provide supervision administration combat health support, and logistical support for operating an internment facility interming EPWs/CIs or housing DCs	2 compound control sections (2 three-man teams) a work project section (1 two-man team) a personnel section and a supply section	Provide I/R operations support	Provide command, control, and supervision of up to 1,000 EPWs/CIs or 2,000 DCs. Provide supply and subsistence support (to include supervision of food preparation) for up to 1,000 EPWs/CIs or 2,000 DCs. Direct the activities related to assigning and supervising work projects for EPWs/CIs. Augment the MP I/R battalion in processing and maintaining records for up to 1,000 EPWs/CIs or 2,000 DCs	MP company (guard) for prisoner guard services
MP Company (Escort Guard)	Provide supervisory and security personnel for evacuating and/or moving EPWs/CIs	4 platoons with 3 squads each. Each squad has a squad leader and 3 three-man teams. Total 36 teams	Provide I/R operations support	Provide security for the movement of the following numbers of POWs or CIs by the methods indicated: Marching - 1 000 to 1,500 Vehicle - 1,500 to 2,000 Rail - 2,000 to 3 000 Air - 2 125 to 2 406	Corps/EAC transportation assets for movement of EPWs/CIs
MP Company (Guard)	Provide guards for EPWs/CIs or US prisoners installations and facilities	3 platoons with 3 squads each. Each squad has a squad leader and 2 five-man teams. Total 18 teams	Provide I/R operations support	Provide security for a confinement facility containing up to 500 US military prisoners. Provide guards for securing 1 EPW/CI compound containing up to 2,000 EPWs/CIs or 4,000 DCs. Provide security guards for 3 railway terminals, each having up to 8 tracks (includes EPW/CI rail movement operations and protection of sensitive material within the terminal.) Provide guards for 1 military installation or facility up to 240,000 square yards in size, containing sensitive material (This unit can provide guards for material transit.)	None
MP I/R Processing Squad	Process EPWs/CIs	1 squad leader and 1 eight-man processing squad	Provide I/R operations support. Augment the I/R battalion processing capability to meet operational requirements	Provide processing capabilities of about 8 EPWs/CIs per hour	None

Table 1-1 Unit Descriptions (continued)

MP Unit	Mission	Action Elements	Support Role	Capabilities (Include But Are Not Limited to [See TOEs for Details])	Augmentation Needed for Mission Accomplishment
I/R Brigade Liaison	Expand the MP brigade (I/R) or ASCC C2 capabilities	Liaison officer and support staff	Provide I/R operations support	When assigned to the MP I/R brigade, provide staff augmentation that expands the brigade's staff planning, coordination, and C2 capabilities for 3 MP I/R battalions. When assigned to the ASCC, provide I/R staff augmentation and a liaison link with allied/HN forces to ensure that the care and handling of US captured EPWs/CIs is in compliance with the Geneva Conventions	None
I/R Camp Liaison Team	Provide continuous accountability of EPWs/CIs captured by US forces and transferred to an allied/HN for internment	Liaison officer and support staff	Provide I/R operations support	Provide advice, as requested, to commanders and staffs of allied/HN-operated internment facilities. Verify arrival forward records, and provide continuous accountability for US captured EPWs/CIs interned in allied/HN facilities. Monitor prisoner treatment to ensure compliance with the Geneva Conventions. Receive/certify allied/HN requests for reimbursement of expenses associated with interning EPWs/CIs captured by US forces	None
I/R Processing Liaison Team	Process and verify the transfer of EPWs/CIs captured by US forces to a allied/HN facility	Liaison officer and support staff	Provide I/R operations support	Provide processing and transfer capability for US-captured prisoners to an allied/HN EPW/CI facility	None
MP Detachment (EPW Evacuation)	Provide evacuation support of EPWs	EPW coordination officer and staff plus 10 one-man POD/POE teams and 3 two-man POE teams	Provide I/R operations support	Coordinate administrative, logistical, and transportation support for up to 7 PODs and 6 POEs used for out-of-theater EPW evacuation and the escort guard personnel that support the movements. Coordinate for theater security at PODs/POEs and intermediate refuel points	Responsible POD/POE security forces

Table 1-1 Unit Descriptions (continued)

MP Unit	Mission	Action Elements	Support Role	Capabilities (Include But Are Not Limited to [See TOEs for Details])	Augmentation Needed for Mission Accomplishment
MP Detachment (Internment Resettlement Information Center (IRIC))	Provide a US central agency in each theater of war to receive process maintain disseminate, and transmit the required information and data relating to EPWs, American POWs, CIs, and DCs within the theater	Command and staff personnel	Provide I/R operations support Serve as the single source for collection and storage of EPW/CI information in theater. Forward information to the National Prisoner of War Information Center at DA	Collect process, and disseminate (to authorized agencies) information regarding interned personnel detained in theater and those released to the custody of allied/UN authorities within theater. Receive, document, and disseminate to the theater commander information received regarding American POWs, CIs, and foreign nationals who are captured, missing, or otherwise detained. Receive, store, and dispose of personal property belonging to interned personnel who have died, escaped, or been repatriated and any property belonging to enemy soldiers killed in action that is not disposed of through grave registration channels	None
MP Detachment (I/R) (Confinement)	Augment an MP battalion (I/R) in operating a confinement facility. Provide supervision administration, combat health support, and logistical support of US military prisoners	Corrections officer and confinement facility staff	Provide I/R operations support	Provides a control team for the command control and supervision of US military prisoners and a disciplinary guard team to supervise custodial personnel for a maximum custody of 500 prisoners. Provide administration, health service, supply, and food service personnel to augment the battalion in providing these services for internees. (The food service personnel supervise and train US military prisoners working in the internee dining facility)	MP battalion (I/R) for command, staff, planning, and operational support AND MP company (guard) for prisoner guard services

Table 1-1 Unit Descriptions (continued)

MP Unit	Mission	Action Elements	Support Role	Capabilities (Include But Are Not Limited to [See TOEs for Details])	Augmentation Needed for Mission Accomplishment
MP Confinement Facility Detachment	Provide C2 staff planning and logistical support for a confinement facility for US military prisoners	Commander and facility staff	Provide I/R operations support	Provide command control, and administrative support for a confinement facility	MP guard company to provide exterior perimeter security and required guard support to the confinement facility AND MP correctional team supervisor (TOE 19553LE) to provide supervision of the guard force AND MP correctional team work supervisor (TOE 19553LF) to provide supervision of prisoners
MP Correctional Team Supervisor	Provide correctional supervision of prisoner work guard forces within a confinement facility	2 two-man teams	Provide I/R operations support	Provide correctional supervision to guard force personnel and US military prisoners within a modular-configured confinement facility	None
MP Correctional Team Work Supervisor	Provide direct control and supervision of military prisoners within a confinement facility	1 two-man team	Provide I/R operation support	Provide correctional control, supervisory functions, and escort duties for military prisoners within a modular-configured confinement facility	None
MILITARY POLICE CRIMINAL INVESTIGATION (CID) UNITS					
MP Group (CID)	Provide command, control, staff planning, and supervision for all CID elements within the theater	Command and staff elements	Provide L&O	Provide command, control, staff planning, and supervision over all CID elements within the theater NOTE: The Criminal Investigation Command is a stovepipe organization.	None

Table 1-1. Unit Descriptions (continued)

MP Unit	Mission	Action Elements	Support Role	Capabilities (Include But Are Not Limited to [See TOEs for Details])	Augmentation Needed for Mission Accomplishment
MP Battalion (CID)	Provide command, control, staff planning, and supervision for all assigned or attached CID elements	Command and staff elements	Provide L&O	Provides command control, staff planning, and supervision over all assigned and attached CID elements	None
MP Detachment (CID) HQ Cell	Provide C2 evidence custody control and investigative administration support Coordinate for personnel administration and logistic support	Commander and support staff	Provide L&O	Provide C2 of assigned CID SA sections and/or teams performing all CID operations in their area of responsibility	None
MP Detachment (CID)	Provide criminal investigative support to Army commanders at all echelons	2-man teams The number of teams varies by organization and is as follows DSE heavy - 4 DSE light - 3 Section A - 4 Section B - 4 Supervisory team - 1 Senior team - 1 SA team - 1	Provide L&O	Supervise and conduct criminal investigations	When directed, MP CS, L&O, and MWD support

Chapter 2

Battle Command

Command is the authority a commander in military service lawfully exercises over subordinates by virtue of rank and assignment. Leaders possessing command authority strive to use it with firmness, care, and skill

FM 101-5-1

Battle command is the exercise of command in an operation against a hostile, thinking opponent. Battle command includes visualizing the current state and the desired end state, then formulating concepts of operations to get from one state to the other at the least cost. In addition to visualizing and formulating concepts, battle command encompasses assigning missions, prioritizing and allocating resources, selecting the critical time and place to act, and knowing how and when to make adjustments in the fight. Battle command enables MP commanders to lead, prioritize, and allocate assets required in support of the Army commander. MP commanders must observe, orient, decide, and act on their decisions quickly. Information is the key element in the battle-command process, therefore, the commander must have accurate and timely information upon which to base his decisions.

OVERVIEW

2-1 The battle command of MP units is typically decentralized due to the nature of their CS functions, METT-TC, and the needs of the Army commander. This places the burden of sound, timely decision making to the lowest levels. MP leaders must develop a keen sense of situational awareness and visualization, and they must constantly track the actions of supported units.

BATTLEFIELD VISUALIZATION

2-2 The ability to visualize the battlefield is a critical element of battle command. Battlefield visualization is an essential leadership attribute and is critical to accomplishing the mission. It is learned and attained through training, practice, experience, technical and tactical knowledge, and available battle-command technologies. It results when the MP commander understands the higher commander's intent, his assigned mission, the enemy, and the friendly force's capabilities and limitations. See Appendix D for further information on command technologies.

2-3 Battlefield visualization includes the MP commander's view of what his forces will do and the resources needed to do the mission. He envisions a sequence of actions that will cause his MP forces to perform at the desired end state. Ultimately, the MP commander's battlefield vision evolves into his intent and helps him develop his concept of operations.

COMMANDER'S INTENT

2-4. The commander's intent is a key part of Army orders. It is a clear, concise statement of what the force must do to succeed with respect to the enemy, the terrain, and the desired end state. It provides the link between the mission and the concept of operations by stating key tasks. These tasks, along with the mission, are the basis for subordinates to exercise initiative when unanticipated opportunities arise or when the original concept of operations no longer applies. MP leaders at all echelons must ensure that the mission and the commander's intent are understood two echelons down (see FM 101-5).

CONCEPT OF OPERATIONS

2-5. The commander's intent does not include the method by which the MP units will accomplish the mission. This method is called the commander's concept of operations. It must—

- Convey the commander's vision of how to accomplish the mission in a manner that allows his subordinates maximum initiative.
- Build around intelligence gathering and the precise employment of MP resources.
- Provide the basis for task organization, scheme of maneuver, terrain organization, tasks to subordinates, and synchronization.

COMMAND AND CONTROL RELATIONSHIPS

2-6. MP units are assigned to, attached to, or placed under the operational control (OPCON) of MP or other units they support. OPCON is the authority to perform command functions over subordinate forces. This includes organizing and employing commands and forces, assigning tasks, designing objectives, and giving authoritative direction necessary to accomplish the mission. MP C² relationships may be changed briefly to provide better support for a specific operation or to meet the needs of the supported commander. MP units may be placed under the OPCON of another unit commander for short-term operations. The MP unit remains in this relationship only as long as it is needed for that operation.

MP support to the Bosnian municipal elections consisted of one division and two corps MP companies. These MP assets, attached to Task Force (TF) Eagle, were task-organized from different sources. The division MP company and the PM cell were organic to TF Eagle's mechanized infantry division headquarters, but the two corps MP units were from US Army Forces Command (FORSCOM) MP battalions in CONUS.

SUPPORT RELATIONSHIPS

2-7 MP units on the battlefield provide two types of support—general support (GS) and direct support (DS). Corps and EAC MP units provide GS to their respective corps/EAC subordinate commands. Light, airborne, and air-assault MP companies provide GS to their respective divisions. Heavy-division MP companies provide GS to the division rear and DS to the division's subordinate brigades.

STAFF RELATIONSHIPS

2-8 The PM for each level of command is that command's advisor on MP combat, CS, and CSS operations. The PM—

- Advises the commander and staff about MP abilities/capabilities
- Supervises the preparation of plans and dictates policies
- Coordinates MP operations.
- Assists and supervises the interaction of supporting and supported units
- Reviews current MP operations
- Coordinates with allied forces and HN military and civil police
- Ensures that MP plans and operations supporting the commander's tactical plan are carried out
- Recommends when and where to concentrate the command's MP assets
- Supervises or monitors MP support in the command's AO

2-9 The PM works daily with the commander and staff officers who employ MP resources and whose AORs influence MP support. The PM works closely with the coordinating staff at the appropriate command level to coordinate MP support. He ensures that MP planning is practical and flexible, that plans are coordinated with staff sections and subordinate commands, and that plans reflect manpower and resources needed by MP (This includes the need for C², fire support, equipment, and supplies. It also includes construction, communication, transportation, and aviation support.) As new information is received, the PM reviews, updates, and modifies the plans. He ensures that the echelon commander gets the necessary MP support.

2-10 In the absence of specific directions or orders, the PM plans the use of MP assets. He evaluates the current operations and projects the future courses of action (COAs). He bases his plans on assumptions consistent with the commander's intent and a thorough knowledge of the situation and mission. The PM considers—

- METT-TC
- Current estimates developed by the intelligence preparation of the battlefield (IPB) and the police information assessment process (PIAP)
- The environment within the AO. This includes the climate, the terrain, and obstacles. It also includes the legal authority and status of the force, the width, depth, size, and location of built-up areas, and the attitudes and abilities of the local populace.

- The types of units operating in the area (to include joint, combined, multinational, and interagency units) and the missions and capabilities of these units. This knowledge is imperative to understand their capability to counter threats in their area.
- The specific missions of MP units in the area and the impact that rear-area security operations will have on the ability of these units to perform other functions.
- Personnel, vehicles, and equipment in the MP units.

2-11 Coordination and communication between the PM and Army commanders is essential. Such actions ensure timely and efficient MP support to all levels of command during any operation. The informal, technical chain of coordination is an open line of communication between PMs at different echelons. The informal chain of coordination fosters cooperation and help among the MP elements at each echelon. For instance, when the division PM needs more assets to accomplish added missions, he initiates coordination with the corps PM. If the corps PM can provide support, the division PM formalizes his request for assistance through the division Assistant Chief of Staff, G3 (Operations and Plans) (G3).

Chapter 3

The Threat

In the 40-odd years of the Cold War, in many locations around the world, the Army performed a deterrent role as part of the containment strategy. In other places, at other times, the Army fulfilled the Nation's expectation in operations too small to be called "wars," although no less dangerous. To the soldier on the ground, Operations Urgent Fury in Grenada and Just Cause in Panama were indistinguishable from combat operations of their forefathers. Operations Provide Comfort in Iraq and Restore Hope in Somalia, although peace operations, also proved to be dangerous.

FM 100-1

The end of the Cold War has reduced, but not eliminated, the most immediate threat to the security of the US and other western nations. However, the absence of a dominant, identifiable threat has produced a far more complex and confusing strategic environment than the one that was present during the Cold War. Forward-deployed and CONUS-based ARFOR and civilians are and will continue to be engaged in a range of military actions. These actions stem from deterring conflicts to conducting peacetime engagement operations to providing support to civil agencies at home and abroad.

OVERVIEW

3-1 During the past decade, the US has deployed forces in multiple operations that have included crisis response in combat situations as well as participation in noncombat activities. The Army's presence in South Korea, Saudi Arabia, and Kuwait and its deployments to Somalia, Haiti, Bosnia, and Kosovo are clear indicators that the military must be prepared to face not only the traditional threat, but also a nontraditional, nonecheloned enemy. To support Army commanders successfully, MP leaders must understand the nature and complexity of these threats and how they can potentially affect the desired strategic, operational, and tactical end states.

REAR-AREA AND SUSTAINMENT OPERATIONS

3-2 The rear area for any particular command is the area extending forward from its rear boundary to the rear of the area assigned to the next lower level of command. This area is provided primarily for the performance of support functions. Operations in the rear area assure freedom of action and continuity of operations, sustainment, and C². Sustainment operations are those that enable shaping and decisive operations by assuring freedom of action and

continuity of operations, CSS, and C² (see FM 3-0) Sustainment operations include the following elements

- CSS
- Rear-area and base security
- Movement control
- Terrain management
- Infrastructure development

3-3 During the Cold War, the danger to rear areas included forces that would be deployed in support of major soviet-style operations. The adversaries using the soviet model could be expected to engage in intense combat activity in their enemy's rear area. Their forces were prepared to penetrate into the enemy's rear and to attack and destroy its reserve forces and rear-area installations. To protect the rear areas, the MP were among the first mobile fighting forces available to the battlefield commander and thus, a source of combat power. Today, the Army commander uses the MP's flexibility and their modular-force training, adaptability, and mobility to serve as a combat multiplier throughout his entire AO. During sustainment operations, the MP perform all functions to ensure freedom of maneuver in support of the overall operational effort.

3-4 Failure to protect our forces during sustainment operations normally results in failure of the entire operation. Sustainment operations determine how fast ARFOR reconstitute and how far they can exploit success. The likelihood of MP units encountering the enemy and engaging in direct combat (not only in the rear area, but also during sustainment operations) cannot be underestimated.

3-5 Threats to rear-area and sustainment operations exist throughout the full spectrum of military operations. These threats may be related or independently engaged, but their effects are frequently cumulative. Threats to rear-area and sustainment operations are usually theater-dependent and are not limited to those outlined in this manual. Joint Publication (JP) 3-10 further discusses the threat in the rear area. Although JP 3-10 defines the threat in the context of a JRA, MP leaders can expect the same level of activity anywhere that US forces are deployed.

RECEPTION, STAGING, ONWARD MOVEMENT, AND INTEGRATION OPERATIONS

3-6 Reception, staging, onward movement, and integration (RSOI) operations consist of essential and interrelated processes in the AO that transform arriving personnel and materiel into forces capable of meeting operational requirements. During RSOI operations, the threat encountered will depend mostly on the type of entry, the nature of the operation, and the enemy. During major contingencies, forces deploy from power-projection platforms within the US or forward bases. The PM must plan MP support during the initial stages of the deployment to ensure the protection of follow-on forces and the detection of potential threats (see FM 100-17-3).

3-7 MP support to RSOI operations includes, but is not limited to—

- Conducting AS operations to counter or prevent enemy actions against marshalling and staging areas
- Conducting convoy, airport, and rail security operations
- Conducting populace- and resource-control operations
- Conducting other physical-security and force-protection measures
- Conducting other MP functions (as determined by the PM)

THREAT LEVELS

3-8 The threat is divided into three levels. These levels provide a general description and categorization of threat activities, identify the defense requirements to counter them, and establish a common reference for planning guidelines. MP leaders must understand that this does not imply that threat activities will occur in a specific sequence or that there is a necessary interrelationship between each level.

LEVEL I

3-9 Level I threats include the following types of individuals or activities:

- **Enemy-controlled agents.** Enemy-controlled agents are a potential threat throughout the rear area. Their primary missions include espionage, sabotage, subversion, and criminal activities. Their activities span the range of military operations and may increase during both war and military operations other than war (MOOTW). These activities may include assassinating or kidnapping key military or civilian personnel or guiding special-purpose individuals or teams to targets in the rear area.
- **Enemy sympathizers.** Civilians sympathetic to the enemy may become significant threats to US and multinational operations. They may be the most difficult to neutralize because they are normally not part of an established enemy-agent network, and their actions will be random and unpredictable. During war and MOOTW, indigenous groups sympathetic to the enemy or those simply opposed to the US can be expected to provide assistance, information, and shelter to guerrilla and enemy unconventional or special-purpose forces operating in the rear area.
- **Terrorism.** Terrorists are among the most difficult threats to neutralize and destroy. Their actions span the full spectrum of military operations.
- **Civil disturbances.** Civil disturbances, such as demonstrations and riots, may pose a direct or indirect threat to military operations. Although this threat may not be of great impact during war, it may significantly change and affect MOOTW.

LEVEL II

3-10 Level II threats include the following types of forces:

- **Guerrilla forces.** Irregular and predominantly indigenous forces conducting guerrilla warfare can pose a serious threat to military

forces and civilians. They can cause significant disruptions to the orderly conduct of the local government and services.

- **Unconventional forces.** Special-operations forces (SOF) are highly trained in unconventional-warfare techniques. They are normally inserted surreptitiously into the rear area before the onset of an armed conflict. They establish and activate espionage networks, collect intelligence, carry out specific sabotage missions, develop target lists, and conduct damage assessments of targets struck.
- **Small tactical units.** Specially organized reconnaissance elements are capable of conducting raids and ambushes in addition to their primary reconnaissance and intelligence-gathering missions. Small (size or capability), bypassed conventional units, as well as other potential threat forces, are also capable of conducting raids and ambushes to disrupt operations.

LEVEL III

3-11 Level III threats are made up of conventional forces. Potential threat forces are capable of projecting combat power rapidly by land, air, or sea deep into the rear area. Specific examples include airborne, heliborne, and amphibious operations, large, combined-arms, ground-forces operations, and bypassed units and infiltration operations involving large numbers of individuals or small groups infiltrated into the rear area, regrouped at predetermined times and locations, and committed against priority targets. Level III forces may use a combination of the following tactics as a precursor to a full-scale offensive operation:

- **Air or missile attack.** Threat forces may be capable of launching an air or missile attack throughout the rear area. It is often difficult to distinguish quickly between a limited or full-scale attack before impact, therefore, protective measures will normally be based on the maximum threat capability.
- **Nuclear, biological, and chemical (NBC) attack.** Commanders must be aware that NBC munitions may be used in conjunction with air, missile, or other conventional-force attacks. The NBC weapons could also be used at Level I or II by terrorists or unconventional forces in order to accomplish their political or military objectives.

THREAT-LEVEL MATRIX

3-12 Table 3-1 lists the threat levels and their likely appropriate responses. The threat levels listed are based on the type of threat. The table should not be construed as restricting the response options to any particular threat.

THREAT PRIORITIES

3-13 The threat will attempt to perform the following operations against targets in the rear area:

- Detect and identify targets
- Destroy or neutralize operational weapons-system capabilities
- Delay or disrupt the timely movement of forces and supplies

Table 3-1. Threat Levels

Threat Level	Example	Response
I	Agents, saboteurs, sympathizers, and terrorists	Unit, base, and base-cluster self-defense measures
II	Small tactical units, unconventional-warfare forces, guerrillas, and bypassed enemy forces	Self-defense measures and response forces with supporting fires
III	Large tactical-force operations (including airborne, heliborne, amphibious, infiltration, and bypassed enemy forces)	Timely commitment of a TCF

- Weaken the friendly force's C² network
- Disrupt support to combat forces
- Set the stage for future enemy operations
- Create panic and confusion throughout the rear area

3-14 Typical examples of enemy priority targets include the following

- NBC-weapons storage sites and delivery systems
- Key command, control, communications, computers, and intelligence (C4I) facilities
- Air-defense artillery (ADA) sites
- Airfields and air bases
- Port facilities
- Main supply routes (MSRs) and MSR checkpoints
- Key LOC
- Reserve assembly areas (AAs)
- Troop barracks
- Critical civilian and logistics facilities

THREAT LOCATION

3-15 The fact that the Cold War has ended does not imply that our traditional threat has ended. North Korea and Iraq are constant reminders of this fact. For the near future, Army commanders will fight units with Cold-War-era equipment and tactics. The Army trains and is prepared to fight an enemy capable of interfering with our freedom of maneuver throughout the battlefield. On an extended battlefield with asymmetric threats, the danger to high-value assets (HVAs) (including CSS, C², communication nodes, and MSRs) only increases. The idea that the danger to the rear area decreases as you travel farther away from the forward edge of the battle area (FEBA) is not true. Threat intensity does not depend on geographical location, it depends on what operations the enemy believes must be initiated (and to what degree) to achieve its objective in the rear area. Military commanders depend on the MP to delay and defeat threats in their AO with a mobile reaction force.

COMMUNICATIONS ZONE

3-16 The nature of the COMMZ will encourage Level I and II threats to concentrate along the LOC and other areas of military significance. MP units will encounter an enemy that is capable of disrupting operations throughout the COMMZ while employing terrorist activities, enemy-controlled agent activities, enemy sympathizers, and saboteurs. If the enemy is Level III capable, MP leaders must expect infiltrations and air, missile, or NBC attacks as a precursor to a major Level III operation.

CORPS REAR AREA

3-17 The activities in Levels I and II will be similar in composition and density as in the COMMZ, but they will target key corps units, key facilities, and corps sustainment capabilities. The threat activities, especially at smaller unit levels, may even precede hostilities. MP leaders must be alert and prepared to encounter unconventional forces conducting diversionary or sabotage operations and small combat units conducting raids, ambushes, or reconnaissance operations or collecting special warfare intelligence. With the fast tempo of offensive operations, MP leaders must also be alert and prepared to encounter bypassed forces that can disrupt operations in the corps rear area.

DIVISION REAR AREA

3-18 The division rear area (DRA) contains many types of CS and CSS units and conducts many complex operations. As in the COMMZ and the corps rear area, the full spectrum of Level I, II, and III activities may occur in the DRA. The main target will be the division's HVA (including key C² facilities, airfields, artillery, aviation, and air-defense assets, LOC, and essential CSS units). The threat may conduct diversionary attacks, sabotages, raids, ambushes, and reconnaissance operations to affect the commander's freedom of maneuver and the continuity of operations. Unlike corps MP, the likelihood of division MP encountering bypassed enemy forces is expected. Failure to delay or defeat these forces will impact division operations.

OTHER TYPES OF THREATS

3-19 As US forces are deployed throughout the world, they will have to face nontraditional, asymmetric threats (other than those listed in Table 3-1, page 3-5) that may be geographically specific. As part of situational awareness, and in coordination with military intelligence (MI) and CID personnel, MP leaders must evaluate and assess the impact of these threats in their AO. A TO is vulnerable to any or a combination of the following threats:

- National or international organized crime
- Narcotics traffickers
- Narcotics terrorists
- Extremist groups
- Paramilitary groups
- Ethnic or religious disputes
- Trade in illegal weapons or strategic materials

3-20 MP leaders must be aware that other threats exist and that they have the same potential as the Level I and II threats to disrupt operations in rear-area or sustainment operations. In some instances, the above threats' capabilities or the massing of personnel may have the same potential threat as a Level III threat.

COUNTERING THE THREAT

3-21 The disruption of rear-area and sustainment operations directly affects military efforts. Three types of forces may be used to counter the threat in these areas—a base/base-cluster self-defense force, a response force, or a tactical combat force (TCF).

BASE/BASE-CLUSTER SELF-DEFENSE FORCE

3-22 A base cluster is established when the appropriate echelon rear-operations cell or command post (CP) places geographically contiguous or noncontiguous bases under the control of a headquarters. The base cluster becomes the next higher tactical C² headquarters of those bases. The rear-operations cell or the rear CP may also establish a base cluster for a corps support group (CSG), an area support group (ASG), or other CSS units operating in the corps or division rear areas.

3-23 US ARFOR have the inherent responsibility to contribute as many forces as possible for base defense and local security for themselves and their facilities, installations, and activities. Each base and base-cluster commander must develop a defense plan to detect, defeat, and minimize the effects of Level I and limited Level II threat attacks on his base or base cluster (including NBC attacks). To maximize the unit's mission accomplishment, defense plans must be flexible and allow for differing degrees of security based on the probability of threat activity. Defense plans are given to MP units operating near the base or base cluster. The base commander most often employs a series of defense measures providing internal and perimeter security. His internal reaction forces use organic weapons to neutralize and defeat most low-level threat activity. Although not fully equipped to engage major conventional or unconventional enemy forces that may confront him, a base commander must deploy his personnel to defend themselves until MP, HN, local police, or combat forces (if available) can respond.

RESPONSE FORCE

3-24 A response force is summoned when the base or base cluster is faced with threat forces that are beyond their self-defense capability. If the MP are the designated response force, they must—

- Coordinate with the supported bases or base-cluster commanders to conduct a joint IPB
- Review base and base-cluster self-defense plans
- Exchange signal-operating-instructions (SOI) information
- Identify MP contingency plans to counter likely enemy activities
- Integrate ADA, engineer, chemical, field-artillery (FA), Army-aviation, and close-air-support (CAS) fire support into their plans (if available)

3-25 MP units help the base or base cluster return to its primary mission by defeating Level II threats. MP units closely watch likely avenues of enemy approach, possible landing zones (LZs), drop zones (DZs), C² facilities, and other key installations. They accomplish this through the MMS, AS, and PIO functions.

3-26 If MP units are not the designated response force, they may become the initial response force for units within their AO. When this occurs, they block, delay or, if possible, destroy enemy elements within their capability. If the attack is by a larger or more capable force, they will maintain contact and continue to develop the situation or delay until the appropriate response force appears or the battlefield commander commits the TCF.

TACTICAL COMBAT FORCE

3-27 When the MP response force encounters or engages threats beyond its ability to defeat, it immediately notifies the higher headquarters. The battlefield commander will then evaluate the situation and commit the TCF to defeat the Level III threat. The TCF is normally a combined-arms organization tailored by the corps or division G3, based on METT-TC. The TCF normally receives fire, aviation, or other support needed to fight and defeat the threat. Once the TCF is identified and before it is committed to battle, it will conduct direct coordination with the MP or other response forces regarding the exchange of reconnaissance information, battle-handoff procedures, and contingency plans for TCF operations. Once the TCF is committed, the MP unit performing as the response force becomes OPCON to the TCF commander.

MP AS THE TCF

3-28 The MP brigade or battalion is capable of conducting TCF missions only when properly augmented. MP augmentation may be in the form of fires, small combat units, aviation assets, or CAS. The specific type of augmentation is METT-TC dependent. Additionally, the MP C² headquarters must receive the respective liaison officers to ensure that augmentation forces are synchronized and employed according to their capabilities. The MP commander's situational awareness and battlefield visualization are key elements to TCF operations. Once designated as the TCF, the MP unit commander establishes liaison with the appropriate rear CP to obtain—

- The current rear-area IPB
- The friendly unit disposition
- Defense plans
- Priorities for protection
- The fire-support plan

3-29 Based on the above information, the MP commander conducts his own IPB and develops a concept of operations. He then forwards it to the appropriate higher echelon for coordination and approval.

3-30 The MP's ability to employ organic MP assets as part of the TCF is limited by the following factors:

- **MP availability.** Normally, all MP assets available are committed at all times. The specific function and scope that MP units perform during the operation are determined by the Army commander's needs, the intensity of the conflict, and the availability of MP resources. The commander, with advice from the MP leader, must decide which MP operations must be scaled back, delayed, or shifted before the MP unit can be designated as part of the TCF.
- **MP dispersion.** MP units are normally displaced over a large geographical area. Technological capabilities and mobility allow them to operate over great distances. In today's battlefield, a typical MP company employment covers between 1,000 and 1,200 square kilometers and performs numerous missions in support of all five functions. The distance between elements, the reprioritization and movement of other MP units, the difficult terrain, poor roads, and bad weather may slow down the MP's commitment as a TCF.

Chapter 4

Military Police Functions

Military police support the Army commander's mission to win the battle. They help the commander shape the battlefield so that he can conduct decisive operations to destroy enemy forces, large or small, wherever and whenever the Army is sent to war.

MAJ(P) Anthony Cruz

The MP Corps supports shaping and sustainment operations while performing its five basic functions as a flexible, economy-of-force organization. Through these functions, MP units are able to provide the commander with an array of CS operations across the full spectrum of military operations (see Table 4-1).

Table 4-1 MP Functions

	Functions				
	MMS	AS	PIO	L&O	I/R
Subtasks	Support to river-crossing and breaching operations and passage of lines	Recon operations ADC Base/air-base defense	IPB support PIAP Active and passive roles	Law enforcement Criminal investigations US Customs operations Related L&O training	EPW/CI handling US military prisoner handling Populace and resource control Dislocated civilians
	Straggler and dislocated-civilian control	Response-force/ TCF operations	Information collection and dissemination		
	Route R&S	Critical site, asset, and HRP security	Joint, interagency, and multinational coordination		
	MSR regulation enforcement	Force protection/ physical security Antiterrorism			

NOTE: Subtasks not all-inclusive

OVERVIEW

4-1 MP assets are limited. Specific functions are performed at any given time and are determined by the supported commander's need, the intensity of the conflict, and the availability of MP resources. The supported commander, through the command's PM, sets the priorities for MP operations.

4-2 The PM (based on METT-TC and the available assets) continuously evaluates the trade-off between the MP support that the commander requires and the MP support that can be provided. To meet the priorities set by the

commander's tactical plan, the PM recommends the allocation and employment of MP assets for MP combat, CS, and CSS operations

MANEUVER AND MOBILITY SUPPORT

4-3 The MMS function involves numerous measures and actions necessary to support the commander's freedom of movement in his AOR. The MP expedite the forward and lateral movement of combat resources and ensure that commanders get forces, supplies, and equipment when and where they are needed. This is particularly important in the modern battlefield where there is a greater geographical dispersal of forces and lengthened LOC.

4-4 The MP maintain the security and viability of the strategic and tactical LOC to ensure that the commander can deploy and employ his forces. The MP support the commander and help expedite military traffic by operating traffic-control posts (TCPs), defilades, or mobile patrols, erecting route signs on MSRs or alternate supply routes (ASRs), or conducting a reconnaissance for bypassed or additional routes. The MP move all units quickly and smoothly with the least amount of interference possible.

4-5 As part of the MMS function, the MP support river-crossing operations, breaching operations, and a passage of lines. They also provide straggler control, dislocated-civilian control, route reconnaissance and surveillance (R&S), and MSR regulation enforcement.

RIVER-CROSSING OPERATIONS

4-6 US forces conduct river-crossing operations to move a large force across a river obstacle with a minimum loss of momentum. The MP play a vital role by assisting the force commander in crossing the river as quickly and efficiently as possible. The crossing is usually planned and conducted by the headquarters directing the crossing. As such, a division crossing operation is conducted by a corps. Whether a brigade or division is crossing, the division MP company may also cross to provide uninterrupted support to the division. In these instances, there is a total reliance on the corps MP to support the crossing. The same is true for breaching operations and a passage of lines.

4-7 MP support for river-crossing operations reduces the crossing time and promotes the efficient movement of vehicles. It reduces congestion, speeds the crossing, and enables the maneuver commander to continue his momentum toward his primary objective. The MP establishes staging and holding areas and TCPs to control movement to and from these areas (according to the traffic-control plan). The MP may be called on to provide security for crossing forces at the crossing sites. In most cases, the MP TCPs and engineer regulation points (ERPs) are located on both sides of the river to improve communications and coordination between the units.

4-8 MP employment for river crossing is influenced by METT-TC. The number and placement of MP assets supporting a river-crossing operation varies with the size of the crossing force, the direction of the crossing (forward or retrograde), and the degree of enemy resistance expected or encountered.

4-9 The MP operating inside the crossing areas are OPCON to the crossing-area commander for the duration of the operation. The MP operating outside

of the crossing area are under the command of their appropriate echelon commander

4-10 The main thrust of MP support to river-crossing operations is within the immediate river-crossing site. The MP direct units to their proper locations (such as holding areas and staging areas) and ensure that units move through the area within the time listed on the movement schedule. This is a highly critical aspect of river crossing because the number of crossing sites is limited. MP assets are placed where they can stress MMS operations on MSRs leading into the crossing area.

4-11 The MP also provide AS to allow crossing forces to cross the river without losing momentum or forces. On both near and far sides, the MP are used to recon the crossing unit's flanks and rear to enhance security (see FM 19-4)

BREACHING OPERATIONS

4-12 Breaching operations are conducted to allow forces to maneuver through obstacles. Obstacle breaching is the employment of a combination of tactics and techniques to advance an attacking force to the far side of an obstacle that may be covered by fire. It is perhaps the most difficult combat task a force can encounter. Breaching operations begin when friendly forces detect an obstacle, and they end when the battle handover has occurred between the follow-on forces and a unit conducting the breaching operation (see FM 90-13-1)

4-13 The MP support breaching operations in numerous ways. MP assets are employed based on METT-TC, the available resources, and the commander's priorities. As a minimum, MP support may include, but is not limited to—

- Establishing TCPs along routes leading to or departing from the breaching site
- Establishing holding areas
- Establishing TCPs at the breaching site
- Assisting engineers with temporary route signs
- Establishing straggler-control operations
- Conducting AS operations

4-14 The most critical MP support is provided at the breaching site. The MP provide the commander with a means to control traffic flow to appropriate lanes. When multiple lanes branch off of a single far-recognition marker, the MP assist in directing the formation through various lanes. They also assist in modifying the traffic flow when lanes have been closed for maintenance or expansion. The MP conduct close coordination with the crossing-force commander and the TF commander executing the breaching operation. The MP enable the commander to make last-minute changes in traffic flow, thereby giving him increased flexibility to react to the enemy situation.

PASSAGE OF LINES

4-15 A passage of lines is an operation in which a force moves forward or rearward through another force's combat positions with the intention of moving into or out of contact with the enemy. The passage of lines is a high-

risk military operation that requires close coordination between the passing unit, the stationary unit, and the MP providing the support

4-16 The MP help reduce confusion and congestion during a passage of lines. They provide security in areas surrounding passage points and passage lanes to ensure that the passing unit has priority for using routes to and through the areas. The headquarters directing the operations sets the route's priority. The MP can support a forward, rearward, or lateral passage of lines. Before the actual operation, the MP in the AO conduct an area or zone reconnaissance to become familiar with the routes to, through, and beyond the area of passage. This enables the MP to extend the commander's C² by providing directions at passage points and by guiding the units through the passing lanes. Maintaining unit integrity and reducing incidents of stragglers is vital to maintaining the passing unit's momentum in a forward passage of lines. The MP perform aggressive straggler- and dislocated-civilian-control operations to prevent possible infiltration of the enemy.

4-17 A passage of lines is usually planned and coordinated by the headquarters directing the passage. A division's passage of lines is planned and coordinated by the corps headquarters. The detailed plans are made and coordinated between the divisions involved. Close coordination between the division and corps PMs is essential. An MP unit may be the unit involved in passing through the lines of another unit. When conducting a delay of a Level II threat, the MP are likely to conduct a passage of lines with the TCF. To avoid fratricide, close coordination between the MP response-force commander and the TCF is imperative (see FM 19-4).

STRAGGLER CONTROL

4-18 Mobile patrols, TCPs, and checkpoint teams return stragglers to military control as part of their operations. Most stragglers are simply persons who become separated from their command by events in the CZ or while moving through the COMMZ. If a straggler is ill, wounded, or in shock, an MP must give him first aid and, if needed, call for medical evacuation (MEDEVAC). If a straggler is uninjured, an MP directs him to his parent unit or to a replacement unit (as command policies dictate). The MP ensure that stragglers attempting to avoid return to their units are escorted back to their command (as a minimum).

4-19 The MP set up special posts for straggler control following NBC attacks or major enemy breakthroughs that result in large numbers of lost, dazed, and confused military personnel. Mobile MP teams operate between posts, and they also direct or collect stragglers. Straggler collection points may be needed if many stragglers are present in a combat theater. If allied forces are present in the theater, each nation establishes a collection point for its own personnel. MP teams are aware of each allied location and are prepared to assist allied soldiers in returning to their respective command. The MP use available transportation assets to transfer stragglers from TCPs and checkpoints to a straggler collection point. At the collection point, they are screened and sorted for removal to a medical facility or returned to their units to reconstitute the tactical commander's combat force.

4-20 The MP report information about stragglers with whom they come in contact. This information is compiled by the MP headquarters and forwarded through appropriate channels to the higher command. Information given by stragglers that is of immediate tactical value is reported without delay.

DISLOCATED-CIVILIAN CONTROL

4-21 The MP expediting traffic on MSRs may encounter dislocated civilians that could hinder military traffic. The MP assist and divert dislocated civilians from MSRs and other areas to I/R facilities. They may also deny the movement of civilians whose location, direction of movement, or actions may be a threat to themselves or to the combat operation. The HN government is responsible for identifying routes for the safe movement of dislocated civilians out of an AO. If needed, the MP assist the civil-affairs unit and the HN in redirecting dislocated civilians to alternate routes established by the HN government.

4-22 The US forces do not assume control of dislocated civilians unless requested to do so by the HN or unless operating in an environment with a hostile government. When the senior US commander assumes responsibility, the MP coordinate with civil affairs to set up TCPs at critical points along the route to direct dislocated civilians to secondary roadways and areas not used by military forces. As required, MWD teams may be used as a show of force or as a deterrent to assist with uncooperative personnel.

ROUTE R&S

4-23 The MP conduct hasty and deliberate route reconnaissances to obtain information on a route and nearby terrain from which the enemy can influence troop movement. A route reconnaissance focuses on continually monitoring the condition of MSRs, ASRs, and other areas. MP patrols look for restricting terrain, effects of weather on the route, damage to the route, NBC contamination, and enemy presence or absence. When enemy activity is spotted, the MP report it, maintain surveillance, and develop the situation. To gather information for proposed traffic plans, they look at the type and number of available routes, and they check load classifications, route widths, obstructions, and restrictions.

MSR REGULATION ENFORCEMENT

4-24 The MP undertake MSR regulation enforcement to keep the routes free for DSS operations. MP units support the command's MSR regulation measures as stated in the traffic-regulation plan (TRP). The TRP contains specific measures to ensure the smooth and efficient use of the road network. It assigns military route numbers and names, the direction of travel, highway regulation points, and preplanned MP TCPs. Most importantly to the MP, it gives the route's control classification. The MP ensure that classified routes are used only by authorized traffic. Vehicles traveling on roads too narrow for their passage or on roads unable to support their weight can obstruct the route.

4-25 To expedite traffic on MSRs, the MP operate special circulation control measures such as—

- Temporary route signing
- Static posts such as TCPs, roadblocks, checkpoints, holding areas, and defilades at critical points
- Mobile teams patrolling between static posts and monitoring traffic and road conditions

4-26 They also gather information on friendly and enemy activities and help stranded vehicles and crews. The MP also place temporary route signs to warn of hazards or to guide drivers unfamiliar with the route. Using these measures, the MP exercise jurisdiction over the road network in the AO and coordinate with the HN (whenever possible) to expedite movement on MSRs.

AREA SECURITY

4-27 The MP perform the AS function to protect the force and to enhance the freedom of units to conduct their assigned missions. The MP who provide AS play a key role in supporting forces in rear-area and sustainment operations. The MP are a response force that delays and defeats enemy attempts to disrupt or demoralize military operations in the AO. The MP's mobility makes it possible for them to detect the threat as they aggressively patrol the AO, MSRs, key terrain, and critical assets. The MP's organic communications enable them to advise the appropriate headquarters, bases, base clusters, and moving units of impending enemy activities. With organic firepower, the MP are capable of engaging in decisive operations against a Level II threat and delaying (shaping) a Level III threat until commitment of the TCF.

4-28 Throughout all aspects of the AS function, the MP perform counteractions to protect the force and to prevent or defeat a Level II threat operating within the MP's AO. MP countermeasures may include implementing vulnerability assessments, developing procedures to detect terrorist actions before they occur, hardening likely targets, and conducting offensive operations to destroy the enemy. The MP use checkpoints and roadblocks to control the movement of vehicles, personnel, and materiel and to prevent illegal actions that may aid the enemy. The use of these control measures serves as a deterrence to terrorist activities, saboteurs, and other threats. However, at the same time, checkpoints and roadblocks expose the MP to these potential threats. To counter this fact, the MP may upgrade or harden vehicles and defensive positions.

4-29 The MP provide combat power to protect the C² headquarters, equipment, and services essential for mission success. The MP provide the battlefield commander with a light, mobile fighting force that can move, shoot, and communicate against any threat. Major subtasks associated with the AS function include reconnaissance operations, area damage control (ADC), base/air-base defense, response-force operations, and critical site, asset, and high-risk personnel (HRP) security.

RECONNAISSANCE OPERATIONS

4-30 As part of their AS mission, the MP serve as the eyes and ears of the battlefield commander by seeking out the enemy and reporting information obtained by recon patrols. The MP conduct area and zone reconnaissances,

screening, surveillance, and countersurveillance to gain information to help guard against unexpected enemy attacks in the AO. The MP monitor likely avenues of approach and potential LZs and DZs. They become familiar with towns and other populated areas, ridgelines, woods, and other terrain features from which the enemy can influence movements along road networks. The MP pay close attention to areas near facilities designated critical by the commander. These areas include key MSR bridges and tunnels, depots, terminals, logistics-support bases, ammunition supply points (ASPs), communications centers/nodes, and C² headquarters. The MWD teams provide explosive detection and personnel detection/tracking capabilities that enhance reconnaissance operations (especially in urban terrain).

AREA DAMAGE CONTROL

4-31 MP units take measures to support ADC before, during, and after hostile actions or natural and man-made disasters. The ADC actions integrate CS and CSS functions for many units. Engineers, medical personnel, and Army aviators work closely to ensure quick relief operations. The MP provide MSR regulation enforcement, refugee control, and some local security when required. As with reconnaissance operations, the MP may use MWD explosive-and personnel-detection capabilities to augment all MP missions in rear-area and sustainment operations.

BASE/AIR-BASE DEFENSE

4-32 The MP are the base and base-cluster commanders' links for detection, early warning, and employment against enemy attacks. The information gathered is dispersed throughout the rear area to help apprise the commander of enemy activities near bases. Base defense is the cornerstone of rear-area security. When the threat exceeds the base/base-cluster capability, the base/base-cluster commander requests MP assistance through the appropriate C² element.

4-33 Air-base defense requires special MP coordination with the US Air Force (USAF). The MP treat air bases like any other base or base cluster. A USAF air base may house the base-cluster commander, or it may be a cluster by itself. The MP are responsible for the air base's external defense. Its internal defense is primarily the responsibility of the Air Force's security forces. The security force provides in-depth defense for weapons, weapons systems, command centers, personnel, and other priority resources established by the base commander.

4-34 The security force is trained and equipped to detect, delay, and deny Level I and II threats. If a Level III threat is present, the security force is tasked with delaying actions, however, the HN, a sister service, or other support must be employed to defeat this threat. If the security force requires assistance to defeat a Level II threat, it may rely on MP response forces or another response force to assist in the defense. If available, the MP response force will react to the air-base defense, just as it would for any other base or base cluster within the MP's AO. However, the key to successful MP employment depends on the critical exchange of information before and during the MP employment. Good communications, an understanding of the

defense plan, and liaison operations are vital in preventing responding forces from entering a situation that could result in fratricide

RESPONSE-FORCE OPERATIONS

4-35 The MP are the base and base-cluster commanders' response force against enemy attacks in rear-area or sustainment operations. The MP gather information about the enemy while performing missions throughout the AO. This information provides commanders with enemy activity near bases. When needed, the MP provide a mobile response force to respond to bases under attack and to destroy the enemy. A base commander's defense plan is the cornerstone for protecting rear-area and sustainment operations. The base commander is responsible for defeating all Level I threats. When this threat exceeds his capabilities, he requests MP support. The MP located near bases or patrolling or conducting AS operations consolidate their forces, respond as quickly as possible, and conduct combat operations to destroy the enemy. If needed, the MP conduct a battle handover to the TCF.

4-36 MP forces performing as a response force are capable of conducting the following offensive operations:

- A movement to contact
- A hasty ambush
- A hasty attack
- A delay
- A call for fire
- A repel attack against critical sites
- A defense of critical sites

4-37 To conduct these missions, the MP consolidate into squads or platoons to delay, defeat, or defend against the threat. See FMs 71-3 and 71-100 for more information on battle-handover operations.

CRITICAL SITE, ASSET, AND HRP SECURITY

4-38 The MP perform their AS function across the entire designated AO. When the MP provide security around a critical site or asset, they usually provide a mobile security screen, taking advantage of its weapons and communications platforms. This standoff protection detects and defeats the threat before it can move within direct-fire range of the facilities. The MP may be tasked to provide detail security to key facilities, assets, and personnel.

4-39 The MP provide security to major CPs and other facilities within the AO. Their employment maximizes mobility, lethality, and communications capabilities as a security screen. They may be required to establish local AS measures (such as checkpoints and listening/observation posts) to further protect these facilities. The MP provide internal access-control points to critical facilities, and they act as a response force. When the critical CP relocates, the MP provide in-transit security. Other types of critical site security include ASPs, deep-water ports, petroleum, oil, and lubricants (POL) terminals and pipelines, trains and railways, and air bases.

4-40 The MP may provide convoy security for top-priority units transporting especially critical supplies to combat forces. MP assets should be employed

primarily on aggressive patrolling, route, area, and zone reconnaissance measures that would create a safe and secure environment for all types of vehicular and unit movement

4-41 The MP and the CID provide protective services to designated key personnel by providing access control to restricted areas within CPs, providing in-transit security, or providing static security measures around the clock. The MP coordinate with the CID when close-in protection of key personnel is needed. The MP and the CID also provide training for personal-protection countermeasures. The MWD teams may be employed to enhance MP and CID detection and protection capabilities.

INTERNMENT AND RESETTLEMENT

4-42 The Army is the Department of Defense's (DOD's) executive agent for all EPW/CI operations. Additionally, the Army is DOD's executive agent for long-term confinement of US military prisoners. Within the Army and through the combatant commander, the MP are tasked with coordinating shelter, protection, accountability, and sustainment for EPWs/CIs. The I/R function addresses MP roles when dealing with EPWs/CIs, dislocated civilians, and US military prisoners.

4-43 The I/R function is of humane as well as tactical importance. In any conflict involving US forces, safe and humane treatment of EPWs/CIs is required by international law. Military actions on the modern battlefield will result in many EPWs/CIs. Entire units of enemy forces, separated and disorganized by the shock of intensive combat, may be captured. This can place a tremendous challenge on tactical forces and can significantly reduce the capturing unit's combat effectiveness. The MP support the battlefield commander by relieving him of the problem of handling EPWs/CIs with combat forces. The MP perform their I/R function of collecting, evacuating, and securing EPWs throughout the AO. In this process, the MP coordinate with MI to collect information that may be used in current or future operations.

4-44 Although the CS MP unit initially handles EPWs/CIs, modular MP (I/R) battalions with assigned MP guard companies and supporting MWD teams are equipped and trained to handle this mission for the long term. A properly configured modular MP (I/R) battalion can support, safeguard, account for, guard, and provide humane treatment for up to 4,000 EPWs/CIs, 8,000 dislocated civilians, or 1,500 US military prisoners.

EPW/CI HANDLING

4-45 The MP are tasked with collecting EPWs/CIs from combat units as far forward as possible. The MP operate collection points and holding areas to temporarily secure EPWs/CIs until they can be evacuated to the next higher echelon's holding area. The MP escort-guard company assigned to the MP brigade (I/R) evacuate the EPWs/CIs from the corps's holding area to the COMMZ's internment facilities. The MP safeguard and maintain accountability, protect, and provide humane treatment for all personnel under their care.

4-46 In a mature TO, MP (I/R) units process EPWs/CIs collected by MP teams and other units in the CZ. MP guard companies assigned to the MP (I/R) units guard EPWs/CIs at designated camps (see FM 19-40)

POPULACE AND RESOURCE CONTROL

4-47 Populace and resource control (PRC) denies adversaries or insurgents access to the general population and resources. The MP supports civil-affairs personnel and the tactical commander in planning and conducting PRC programs employed during all military operations. These programs may consist of curfews, movement restrictions, resettling dislocated civilians, licensing, ration control, regulation enforcement, amnesty programs, inspecting facilities, and guarding humanitarian-assistance distributions. The MP also direct dislocated civilians to resettlement camps where they are cared for while NGOs work to coordinate their relocation.

4-48 The MP's security capability, acceptability, and interface with the populace make them suitable as the primary forces of choice in these operations. The MP I/R units are specifically designed to fill this need (see FM 41-10)

US MILITARY PRISONERS CONFINEMENT

4-49 The MP detain, sustain, protect, and evacuate US military prisoners. Whenever possible, soldiers awaiting trial remain in their units, unless reasonable grounds exist to believe that they will not appear at the trial, the pretrial hearing, or the investigation or that they will engage in serious criminal misconduct. Under either of these two pretrial confinement instances, the commander must also reasonably believe that a less severe form of restraint (such as conditions of liberty, restriction in lieu of apprehension, or apprehension) are inadequate. When these circumstances exist and other legal requirements are met, US military personnel may be placed in pretrial confinement under the MP's direct control. Convicted military prisoners are moved as soon as possible to confinement facilities outside of the AO.

4-50 MP confinement operations parallel (but are separate from) the MP's EPW/CI operations. No member of the US armed forces may be placed in confinement in immediate association with an EPW or other foreign nationals who are not members of the US armed forces. A confinement facility is maintained within the TO only if distance or the lack of transportation requires such a facility. When military prisoners are retained in theater, temporary field detention facilities may be established in the CZ and a field confinement facility in the COMMZ (see FM 19-40 and AR 190-47)

LAW AND ORDER

4-51 The L&O function consists of those measures necessary to enforce laws, directives, and punitive regulations. The MP's L&O function extends the battlefield commander's C². The MP, in close coordination with the CID, work to suppress the chance for criminal behavior throughout the AO. By coordinating and maintaining liaison with other DOD, HN, joint, and multinational agencies, the MP at all levels coordinate actions to remove

conditions that may promote crime or that have the potential to affect the combat force. Crime-prevention measures and selective enforcement measures are also performed as part of other functions. For example, the MP investigate traffic accidents and regulate traffic as part of the MMS function. The L&O function includes major areas such as law enforcement, criminal investigations, and support to US Customs operations. The primary units conducting L&O are the L&O detachments, customs teams, and CID units. Both the MWD team and the MP company (CS) also support the L&O function.

LAW ENFORCEMENT

4-52 Law-enforcement operations assist the battlefield commander in preserving his force. The MP dedicate assets to conduct law-enforcement operations based on the commander's needs. Since MP L&O and CID assets may be limited during the initial stages of any operation, the PM depends on the supported commander's development of an effective crime-prevention program and uses established investigative tools (such as inquiries and AR 15-6 investigations) to enforce rules. This will allow the PM to employ limited MP assets to perform other functions. Law-enforcement operations include responding to civil disturbances, conducting raids, investigating traffic accidents, conducting vehicle searches, supporting the commander's force-protection program, and providing support to HN and civil-enforcement agencies. Law enforcement also includes employing special-reaction teams (SRTs), marksman/observer (M/O) teams, and MWD teams.

4-53 The Army conducts counterdrug-support operations that generally fall within several DOD counterdrug-mission categories. The MP support the Army's role rather than directly participating in civil law-enforcement activities (such as searches, seizures, and arrests). When tasked, the MP provide training to law-enforcement agencies in common soldier skills, physical security, and tactical planning and operations. US Code (USC) Title 18, Posse Comitatus Act, Section 1385 prohibits the use of DOD assets to enforce civilian law (federal and state) except in cases and under circumstances expressly authorized by the Constitution or by an act of Congress.

4-54 In multinational operations, the MP may assist with the creation of multinational police units. Circumstances that may support the establishment of these police forces include existing or negotiated terms of international agreements or security-assistance programs, a multinational operational agreement, or appropriate military directives. The MP provide the capability to train foreign MP and/or reconstitute indigenous constabulary forces as part of stability and support operations. The MP can provide the initial mentoring to these forces and provide temporary, emergency law-enforcement capabilities until the foreign military or civilian police forces are functional (see FM 100-8).

CRIMINAL INVESTIGATIONS

4-55 The MP investigate offenses against US forces or property committed by persons subject to military law. Investigations against minor crimes (such as low-value, personal-property thefts or simple assaults) are normally

investigated by the MP's L&O detachment. Investigations against major incidents involving wrongful death, serious bodily injury, and war crimes are referred to special agents of the USACIDC. The USACIDC conducts death investigations in the absence of HN agreements or in conjunction with the HN. The USACIDC special agents are authorized to investigate any alleged criminal conduct in which there is an Army interest unless prohibited by law or higher authority.

4-56 The USACIDC's investigative authority and investigative responsibility outside of the US are determined by international treaty or agreement (including status of forces agreements [SOFAs]), the policies of the HN government, the US ambassador, and AR 195-2. In the absence of such provisions, the following guidelines apply.

- On Army-controlled installations, the USACIDC has the authority to investigate alleged crimes.
- Outside of an Army-controlled installation, the USACIDC may investigate after coordinating with HN authorities.

4-57 In all environments, the USACIDC has the responsibility to investigate all felony crimes involving Army personnel, DA civilians and agencies, and companies working for the Army. The USACIDC investigates war crimes and crimes involving personal and government property affecting the Army's mission (logistics security [LOGSEC]). Other investigations (such as those based on international treaties, SOFAs, and joint investigations with the HN) may be undertaken if requested by the supported commander in support of the overall Army mission. See Chapter 9 for a complete discussion of the USACIDC.

US CUSTOMS OPERATIONS

4-58 The MP support the US Customs Service (USCS), the US Department of Agriculture (USDA), other federal agencies, joint staffs, and commanders who enforce the laws and regulations of the US concerning customs, agriculture, and immigration border clearances. Support to the USCS also includes assistance to federal agencies to eliminate the illegal traffic of controlled substances and other contraband through Army channels. MP support to customs operations are normally performed by specially trained MP customs teams. Although other MP units are not trained in all facets of customs operations, they may assist MP customs teams, the USCS or the USDA, and other federal agencies in the enforcement of applicable laws and regulations. When tasked, the MP/CID supports the investigation of violations of US Codes, DOD or DA regulations, and applicable provisions of SOFAs.

4-59 The MP report violations of customs laws, regulations, inspections, and investigative results to the installation's PM, the supported commander, and affected units. During redeployment from outside the continental US (OCONUS) to CONUS installations, the MP support the USCS or USDA efforts to ensure that personnel, equipment, and materiel meet customs, immigration, and agriculture requirements as stated by all applicable laws and regulations. As with other functions, MWD teams may be employed in support of customs operations for the detection of explosives or narcotics.

During operation Just Cause, an MP platoon temporarily assumed the customs mission at the main terminal of the Torrijos International Airport located just outside of Panama City. Their mission supported the air evacuation of foreign-national civilians and the redeployment of some of the initial-entry US forces.

POLICE INTELLIGENCE OPERATIONS

4-60 The PIO function supports, enhances, and contributes to the commander's protection program, situational awareness, and battlefield visualization by portraying relevant threat information that may affect his operational and tactical environments. This threat information—whether it is police, criminal, or combat information—is gathered while conducting MP functions. The PIO function—

- Demonstrates the MP's/CID's capability to collect relevant threat information actively or passively
- Ensures that all information collected while conducting MMS, AS, I/R, and L&O functions continues to be reported through the proper channels so that it can be analyzed by the Intelligence Officer (US Army) (S2) or the Assistant Chief of Staff, G2 (Intelligence) (G2) with support from the appropriate MP echelon
- Coordinates with USACIDC elements to employ data developed by the USACIDC's programs. These programs include—
 - The Combating Terrorism Program as outlined in AR 525-13 and CIDR 195-1
 - The Criminal Intelligence Program (CIP)
 - Personal-security vulnerability assessments (PSVAs)
 - A crime threat analysis
 - Logistics-security threat assessments (LSTAs)

NOTE: The MP/CID must ensure that criminal information is released according to existing controls and restraints.

- Maintains constant liaison and communication with the higher echelon S2/G2, psychological-operations (PSYOP) units, HN police and other law-enforcement agencies, joint, combined, interagency, and multinational forces, the staff judge advocate (SJA), the CMOC, civil-affairs teams, and the force-protection officer

4-61 The MP brigade commander, the battalion commander, and the PM are responsible for the PIO function. As such, each one must determine the best way to employ the available staff resources to monitor the execution of the PIO function within his command.

IPB PROCESS AND PIO FUNCTION

4-62 The IPB is a systematic, continuous process for analyzing the threat and environment in a specific geographic area. It is designed to support staff estimates and military decision making. Applying the IPB process helps the

commander selectively apply and maximize his combat power at critical points in time and space on the battlefield by—

- Determining the threat's likely COA
- Describing the environment the unit is operating within and the environmental effects on the unit

4-63 The IPB process consists of the following four steps

- **Define the battlefield environment.** The S2/G2 identifies the battlefield characteristics that will influence friendly and threat operations, establishes the limits of the area of interest (AOI), and identifies gaps in current intelligence holdings
- **Describe the battlefield effects.** The S2/G2 evaluates the environmental effects with which both sides must contend. The S2/G2 identifies the limitations and opportunities that the environment offers on the potential operations of friendly and threat forces. This evaluation process focuses on the general capabilities of each force until COAs are developed later in the IPB process. This environmental assessment always includes an examination of terrain and weather, but it may also include discussions of characteristics of geography and infrastructure and their effects on friendly and threat operations
- **Evaluate the threat.** The S2/G2 and his staff analyze the command's intelligence holdings to determine how the threat normally organizes for combat and conducts operations under similar circumstances. When facing a well-known threat, the S2/G2 can rely on historical databases and threat models. When operating against a new or less known threat, he may need to develop his intelligence databases and threat models concurrently
- **Determine the threat's COA.** Given what the threat normally prefers to do and the effects of the specific environment in which he is operating, his likely objectives and the COAs available to him are determined. The S2/G2 develops enemy COA models that depict the threat's available COAs. He also prepares event templates and matrices that focus intelligence and identify which COA the enemy will execute (see FM 34-130)

4-64 Although the S2/G2 has the staff responsibility for the command's IPB, he is not the only one who conducts or needs to understand and use the IPB. Every Army commander and staff member must understand and apply the IPB process during the staff planning process. The MP on the battlefield are no exception. The MP employ the IPB process as their first step in developing and implementing the PIO function within their commands.

4-65 During the IPB process, the S2/G2 uses all available databases, intelligence sources/products, and related MI disciplines to analyze the threat and the environment. The PIO function supports this process by providing the S2/G2 with collected police, criminal, and combat information that can directly and significantly contribute to the success of the MI effort. In addition to the combat information, the PIO function provides additional information on possible criminal threats and COAs that may support the S2's/G2's IPB process and that can be used by the commander to upgrade the force-protection posture.

POLICE INFORMATION ASSESSMENT PROCESS

4-66. Like the S2/G2 uses the IPB process to continuously analyze the threat and the environment in a specific geographical area, MP leaders use the PIAP as a tool to continuously collect, organize, interpret, and gain access to police/criminal information in support of the IPB process. Criminal trends may have an impact on the tactical scenario, and the PIAP is a method used to consider this threat and its impact on friendly forces. MP leaders cannot use the PIAP as a substitute for the IPB process—the PIAP complements the IPB (see Appendix E).

PASSIVE MODE PIO

4-67. Every MP conducts the PIO function in a passive mode during their normal day-to-day operations and across the full spectrum of military operations. In the passive mode, PIO are not a stand-alone function, as such, they cannot be separated from other MP functions.

4-68. During the performance of MMS, AS, I/R, and L&O functions, the MP develop and exchange information with other organizations in the AO. The MP obtain information through contact with civilians, NGOs, IHOs, local and HN police, multinational police, and other security forces. If the MP receive, observe, or encounter information (police, criminal, or combat) while performing these functions, they will immediately submit a report to relay information up the chain of command. This report may be in the form of a size, activity, location, unit, time, and equipment (SALUTE) report, a spot report (SPOTREP), or another appropriate report. When the higher echelon (brigade, battalion, or PM) receives this information, it is simultaneously integrated into the ongoing IPB/PIAP and forwarded to the higher echelon S2/G2 (see Figure 4-1, page 4-16).

4-69. If police/criminal information is obtained, the MP—

- Update the previous police/criminal estimates provided to the S2/G2
- Identify new or potential criminal threats or trends in the AO
- Consider recommending that the supported commander upgrade the force-protection level
- Notify adjacent units of the potential criminal threat that may affect their forces
- Consider reprioritizing MP support to the identified threat area
- Share information with HN/local police and other agencies

4-70. If combat information is obtained, the MP—

- Forward the information to the higher headquarters S2/G2
- Forward the information to the MP chain of command, integrate it into the MP's IPB process and, if necessary, take appropriate action
- Notify the adjacent unit of the potential threat that may affect their forces

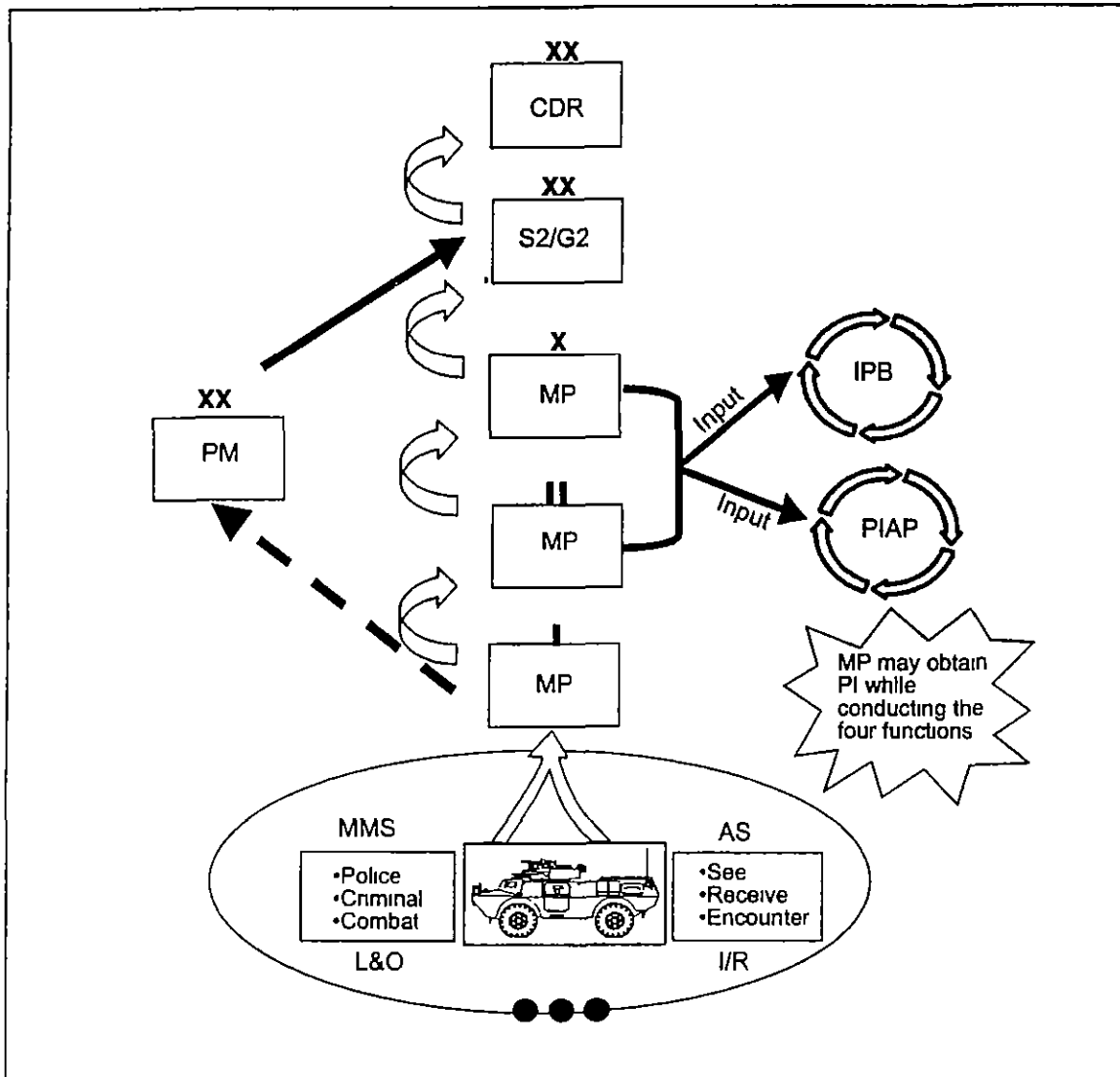

Figure 4-1. PIO—Passive Mode

During Operation Uphold Democracy, an MP team was conducting a TCP as part of a cordon and search operation in Port-au-Prince, Haiti. While performing the task, two civilians approached the MP team informing them of criminal activity in the neighborhood. During the interview, the MP team prepared a sketch of a house and surrounding areas. The team also obtained information describing the criminals and their weapons. Recognizing that the criminal activity was in fact the actions of a political/mercenary group named FRAP, the MP team radioed the platoon leader and forwarded the field interview to higher headquarters. Two days later, a unit from the 10th Mountain Division raided the house, capturing weapons, ammunition, and equipment.

4-71 The preceding vignette demonstrates the MP performing the PIO function in the passive mode. The MP team received the information while conducting a TCP and submitted it through the appropriate chain of command, which resulted in an action taken. This example stresses the importance of submitting information up the chain of command regardless of whether it may be police, criminal, or combat information.

ACTIVE MODE PIO

4-72 The MP perform the PIO function in the active mode and across the full spectrum of military operations when directed by higher headquarters. In this mode, the MP conduct specific MMS, AS, I/R, and L&O missions with the intent to collect information actively in support of the S2's/G2's IPB process or the PIAP.

4-73 When the S2/G2 identifies a gap in the command's knowledge of the threat and the current threat situation, it may be recommended to be included as priority intelligence requirements (PIR). The S2/G2 will then develop a collection plan to assist him in filling this gap. Part of his collection strategy is to select the best collectors available to cover each intelligence requirement. After a thorough analysis (which includes availability, capability, and performance history), the collection manager identifies which collection asset can best be used in response to a given requirement, and the Operations and Training Officer (US Army) (S3)/G3 tasks the asset. If the S2/G2 determines that the MP is the right force to serve as collectors, the S3/G3 will go through the appropriate request channels and task the PM. The S2/G2 will then provide the PM with a specific guideline and a prioritized collection requirement (see FM 34-2).

4-74 On receipt of the mission, the PM will conduct a mission analysis to decide which specific MP function (MMS, AS, I/R, or L&O) is needed to satisfy the S2's/G2's requirement. Once the analysis is completed and the appropriate function selected, the PM will then task subordinate units with the collection mission. Once the mission is completed, the PM may receive another collection tasking or continue with previous MP tasks.

4-75 When the MP commander or the PM conducts the PIAP, he may also encounter a police/criminal information gap. This gap may become the MP commander's police/criminal information requirements (PCIR). If the gap cannot be filled with available data from the S2/G2, the CID, the HN, and other agencies, the MP commander/PM may task subordinate MP units or request CID assistance to support the collection effort. On receipt of the mission, the MP will then conduct a mission analysis and decide which specific MP function (MMS, AS, I/R, or L&O) is needed to satisfy the PM requirement. Once the mission is completed, the MP may receive another collection tasking or continue with previous MP tasks (see Figure 4-2, page 4-18).

4-76 Since any soldier on the battlefield can report police or criminal information, the MP commander or the PM must constantly coordinate and communicate with the S2/G2, PSYOP, and other agencies to obtain information that could be of MP/CID interest. This constant coordination is a key factor for ensuring that the MP/CID has visibility over the police/criminal information that is reported through non-MP channels.

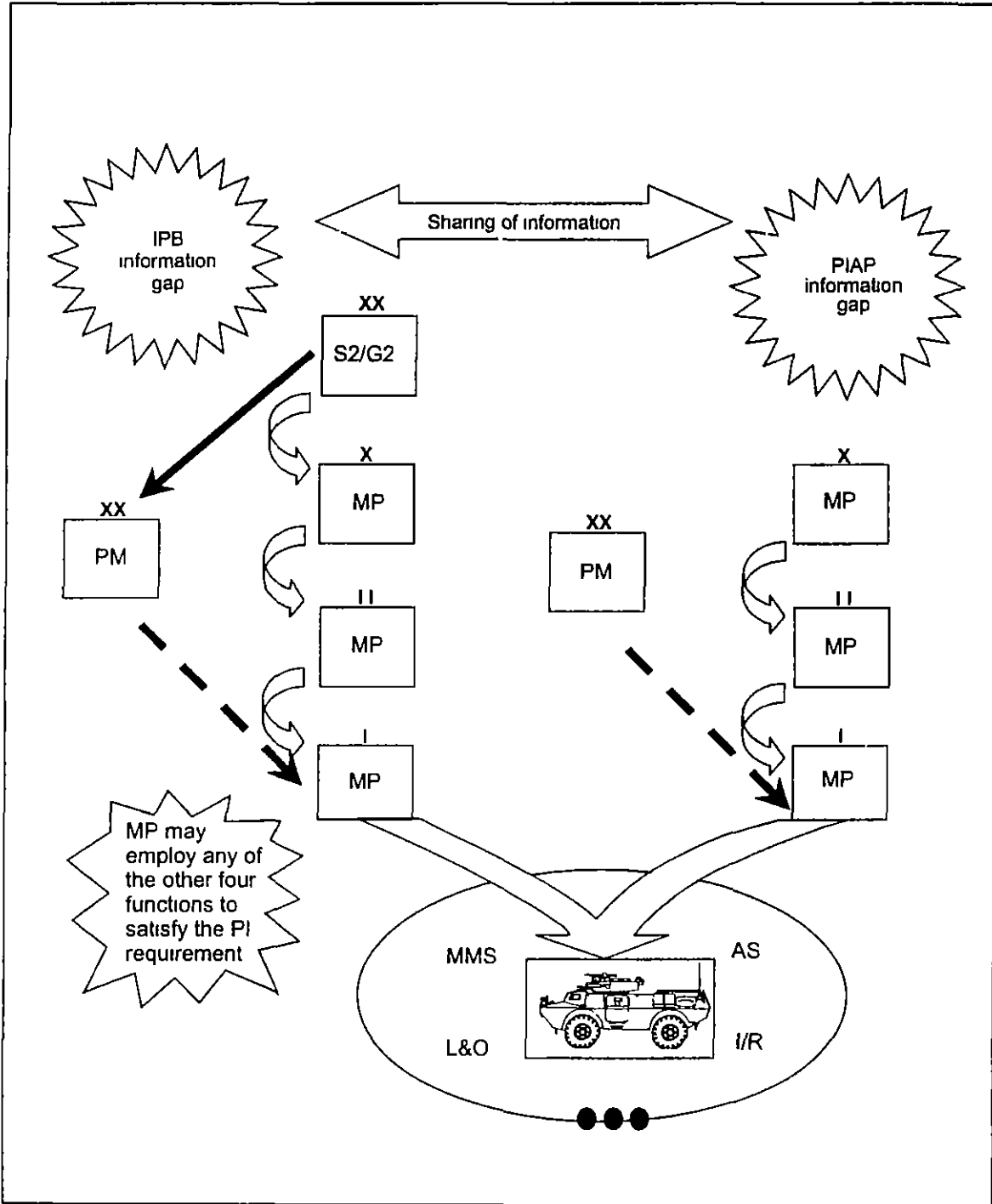

Figure 4-2. PIO—Active Mode

Chapter 5

Military Police Support to Echelons Above Corps

*MP units supporting EAC perform combat, CS, and CSS operations
Like the MP supporting corps and divisions, MP units supporting
EAC units perform the five MP functions based on available assets
and the supported commander's needs*

USAMPS

MP support to EAC includes support to the ASCC and the TSC. The ASCC is responsible for Army Title 10 requirements in support of a combatant commander. This support includes recruitment, organization, supply, equipment, training, servicing, mobilizing, demobilizing, administration, and maintenance functions.

OVERVIEW

5-1 The ASCC may also be responsible for significant DOD- and combatant-commander-designated Army support to other services. As the senior Army commander in the AOR, the ASCC commander tailors and designates ARFOR to accomplish operational-level tasks while conducting major land operations. The ASCC's operational responsibilities include—

- Recommending the proper employment of Army-component forces to the joint-force commander or to the subunified commander
- Accomplishing operational missions as assigned
- Selecting and nominating specific Army units for assignment to subordinate theater forces
- Informing the combatant commander of the Army's CSS effects on operational capabilities
- Providing data to the supporting operations plans (OPLANs) as requested
- Ensuring signal interoperability

5-2 The ASCC provides administrative and logistics (A/L) services to assigned ARFOR and to those of subordinate JFCs. When appropriate, the ASCC delegates the authority for support tasks to a single subordinate Army headquarters. In major operations, the TSC (along with other EAC support commands) would be the ASCC's lead organization for planning, coordinating, executing, or providing required support functions (see FM 100-10).

5-3 The TSC is the senior Army support organization in a theater. Its commander reports to the ASCC or ARFOR commander. The TSC normally operates at the operational level of CSS with links to the strategic and tactical levels. Unity of command is the critical element that the TSC brings to the fight. The TSC is a multifunctional organization that centralizes the

command, control, and supervision of support functions at EAC as directed by the ASCC or ARFOR commander. The TSC's mission is to maximize throughput and follow-on sustainment, including all CSS functions, of ARFOR and other designated supported elements. The TSC is capable of synchronizing logistics and other support operations for the ASCC. It provides area support to EAC units in the COMMZ and sustainment support to tactical forces. This support may include supply, procurement, property disposal, maintenance, transportation, field services, health services, civil-military affairs, MP support, engineer support, religious support, finance support, and personnel and administrative services.

5-4 Units and commands requiring support coordinate with the TSC support-operations staff to secure their initial support, to reestablish support, or to resolve support problems. In a fully developed theater, the TSC coordinates with a corps support command (COSCOM) for support of combat forces, although direct coordination with a division support command (DISCOM) is sometimes necessary. The TSC, augmented by a rear operations center, is also responsible for security operations as directed by the ASCC/ARFOR commander (see FM 63-4).

MILITARY POLICE SUPPORT

5-5 MP support to EAC units is provided through an array of multifunctional MP units. The nature of the operation, METT-TC, and the requirements of the supported commander will determine which type of MP unit is appropriate to augment, assign, attach, or place under OPCON to an EAC unit. The types of MP units that support EAC include CS, I/R, CID, and L&O teams (such as MWD or customs teams).

THE MP BRIGADE (CS)

5-6 The MP brigade (CS) provides MMS and AS to extended LOC within the COMMZ. These supply corridors include ports, inland waterways, railways, pipelines, airfields, MSRs, and MSR critical points. The MP support the users of the COMMZ's LOC by aggressively patrolling the area along the LOC. They play an important role in securing rear areas by performing combat operations against the threat. When properly augmented, the MP brigade headquarters may serve as the TSC's/ASCC's TCF headquarters. The MP provide MMS on the COMMZ MSRs leading into the corps's rear area. The MP implement the plans of HN and US staff elements to control the forward movement of combat resources along the LOC.

5-7 If resources are available, the MP brigade (CS) provides escorts to move US noncombatants (if present) from AA points to theater embarkation terminals. Until the MP brigade (I/R) arrives in theater, the CS MP units also perform EPW, confinement, and other operations normally performed by the MP I/R units.

5-8 The organization of an MP brigade (CS) supporting EAC includes the following:

- A brigade headquarters and headquarters company (HHC)
- Up to six MP battalions (each with up to six companies)

- Numerous L&O detachments and MWD teams

5-9 Additionally, the ASCC's PM or commander may attach or direct OPCON of customs teams to the MP brigade (CS) Battalion and company organization in the MP brigade is the same as that in the corps MP brigade, however, METT-TC determines the number of battalions and companies. The MP brigade (CS) has additional MP companies to provide security for EAC-specific units/activities such as—

- A unified command
- An ASCC and TSC headquarters
- LOC seaports, airfields, and railways
- EAC ammunition storage areas
- EAC petroleum terminals and pipelines

5-10 While the corps MP brigade (CS) MWD teams are employed in a GS role, the MP brigade (CS) MWD teams are employed to augment seaport security and to conduct inspections of postal items to detect explosive materiel and narcotics

5-11 The C² within the MP brigade (CS) is consistent with that in any Army brigade. The MP brigade commander works directly for the EAC commander, the battalion commander works for the brigade commander, and the company commander works for the battalion commander. However, this usual C² relationship may be altered briefly (based on METT-TC) to enhance the overall EAC combat capability for responding to a Level II threat. For example, MP units operating within an ASG's AO may be under the OPCON of the ASG's rear-area operations center (RAOC), which directly tasks MP units responding to Level II threats. The same is true for placing MP units under the OPCON of the EAC's TCF headquarters for responding to Level III threats. Any conflict in mission priorities is resolved through MP C² channels.

5-12 The MP brigade commander is both the MP brigade commander and the EAC's PM. He employs his assets according to METT-TC and the commander's concept of operations. Factors affecting his employment of MP assets include the—

- Nature of the operation (joint, combined, or multinational)
- HN's ability to provide MP-related support (such as port security)
- Custody and location of EPWs/CIs during internment operations until I/R units arrive in theater
- Number of kilometers of the MSR in relationship to movement-control requirements
- Number and kinds of critical facilities
- Number of HRP requiring close-in security
- HN's ability to control the civilian populace, refugees, and dislocated civilians
- Supply distribution strategy
- Risk acceptance and threat in the AO
- Communications requirements (such as using teams as relays)

5-13 Whenever possible, the MP brigade's AO coincides with the territorial responsibility of the supported command. The MP brigade commander assigns

the MP battalion's AO by the above factors as well as by METT-TC. For example, the AOR for an MP battalion may be a large population center of larger geographical areas in which CSS complexes and MSRs are located. But as employment factors and the commander's needs change, so will the MP's AOR. The MP brigade commander must move and tailor his forces to meet the current and projected mission requirements. Unlike many other EAC assets, MP units require 100 percent mobility to shift AOs frequently and rapidly. The following vignette depicts the required MP flexibility to support EAC operations.

During Operation Desert Shield/Storm, MP units were supporting and moving units throughout their AOs at such an extraordinary rate that many of them had to relocate their headquarters multiple times just to keep pace with their changing AO.

5-14 Most EAC MP assets are employed along LOC and around areas of high troop concentration. Few EAC MP are dedicated to support fixed commitments (such as ports, air bases, and headquarters [discussed in paragraph 5-8]). When supporting fixed commitments, MP units provide a mobile security screen, and they man static positions when directed or when based on METT-TC. The MP brigade (CS) may have to plan for and actually perform the evacuation and internment of EPWs/CIs and the confinement of US military prisoners until the MP brigade (I/R) arrives.

THE MP BRIGADE (I/R)

5-15 US policy requires that all persons held in Army custody be accorded humane care and treatment from the moment of custody to their final release. The policy applies to detained or interned civilians as well as to EPWs and confined US military personnel. This policy is equally binding on all US troops (see FM 19-40).

5-16 The ASCC or the TSC supports US laws, regulations, policies, and international agreements by providing personnel, administrative, morale, internment, resettlement, and confinement services for the TO. The TSC's MP brigade (I/R) in the TO provides this support. However, since most I/R units are in the reserve components, the initial I/R operations (as mentioned above) may have to be conducted by the MP brigade (CS). Once the I/R unit arrives in the AO, it is responsible for—

- Providing firm but humane control of EPWs/CIs and dislocated civilians
- Coordinating with HN personnel, military territorial organizations, civilian police authorities, NGOs, private volunteer organizations, and US federal agencies on matters pertaining to I/R operations
- Performing C² operations for all I/R units
- Controlling, employing, and releasing EPWs/CIs as set forth by the Geneva convention and other international laws and by the UN and other governmental bodies
- Handling US military prisoners

5-17 In a mature theater in which large numbers of EPWs are captured, the EPWs' requirements may exceed the capacity of the MP brigade (I/R). In this instance, an I/R command is established. An MP command (I/R) has two or more MP brigades (I/R) and will normally be assigned to the ASCC. When the MP command (I/R) assumes OPCON of the MP brigades (I/R) from the lower echelon, it assumes that echelon's I/R mission.

5-18 If the US decides to transfer captured EPWs/CIs to the HN or to another nation, the US must ensure that the nation is a party to the Geneva convention and is willing and able to comply with the convention. In this case, the number and type of I/R MP units required for processing and retaining EPWs/CIs before the transfer is based on agreements and on METT-TC. Additionally, the MP brigade (I/R) is assigned I/R teams that are located at the processing and transfer points and at the HN or third-country EPW camps. The MP brigade (I/R) liaison team will supervise these dispersed teams to ensure that the HN or the third country provides adequate care and security of US-captured EPWs/CIs and that accountability is maintained according to the Geneva convention.

5-19 The MP brigade (I/R) HHC is the C² element for the brigade's assets. It consists of the following elements:

- A brigade command section
- A company headquarters
- An Adjutant (US Army) (S1)
- An S2
- An S3
- A Supply Officer (US Army) (S4)
- A Civil-Affairs Officer (US Army) (S5)
- A Communications Officer (US Army) (S6)
- Finance and accounting
- Medical operations
- Public affairs
- A unit ministry team
- An SJA
- An inspector-general (IG) section

5-20 Other brigade assets may include the following:

- An MP I/R BLD
- An I/R information center
- An MP escort-guard company
- An MP I/R battalion headquarters
- MP I/R (EPW/CI) detachments
- MP I/R (confinement) detachments
- MP guard companies
- MWD teams
- Processing squads, processing liaison teams, camp liaison teams, and evacuation teams (all as required to support EPW transfer or to conduct an out-of-theater evacuation)

5-21 The MP brigade (I/R) subordinate units are employed most often in the COMMZ near CSS facilities and are placed near sea, air, and rail terminals. They receive, process, and intern EPWs/CIs; confine US military prisoners, or assist in the resettlement of refugees or dislocated civilians.

5-22 The MP brigade (I/R) escort-guard company supports the evacuation of EPWs/CIs from the CZ. The company has a company headquarters and four platoons. The escort-guard company requires sufficient mobility to transport MP personnel to the CZ and to operate mobile teams while escorting the EPWs/CIs. The MP go forward to the corps's holding area to take custody of the EPWs/CIs. They may go forward to division collecting points, if distances and resources permit. Using any means of available transportation, the MP ensure that the EPWs/CIs are quickly evacuated to MP battalions (I/R) in the COMMZ. Close coordination with the EAC and corps movement-control centers and the corps MP brigade is required to ensure that transportation assets returning to the COMMZ are employed to evacuate EPWs/CIs from the corps's holding area. Walking wounded EPWs/CIs are evacuated by the same means as other EPWs/CIs, while litter patients are evacuated through medical channels. Guarding EPWs/CIs while in the MEDEVAC channels and during their hospitalization is not an MP mission, therefore, there is not an MP force structure to support this mission. In most instances, the impact of having the MP perform this mission causes trade-offs in missions for which they are responsible.

5-23 The theater MP brigade (I/R) and out-of-theater MP brigade (I/R) subordinate units will evacuate EPWs to internment sites within CONUS (if directed). The theater brigade structure is based on the projected capture rate over time and available out-of-theater transportation assets (frequency and capacity). The out-of-theater brigade structure is based on the total EPW/CI population, the number of internment sites, transportation nodes, and escort requirements. Theater escort-guard MP move the EPWs/CIs to the seaport and aerial port of embarkation (SPOE/APOE). The escort-guard MP assigned to the out-of-theater brigade escort the EPWs/CIs from the theater ports of embarkation (POEs) to the out-of-theater internment sites. The out-of-theater brigade is assigned an I/R evacuation detachment, which is employed at and coordinates the evacuation from the theater POEs, through the out-of-theater ports of debarkation (PODs), to the out-of-theater facilities.

THE MP BATTALION (I/R)

5-24 The MP battalion (I/R) is a modular organization and can be configured to operate internment facilities for EPWs/CIs, confine US military prisoners, or resettle dislocated civilians. When performing EPW/CI internment operations, the MP brigade (I/R) has up to 7 MP battalions (I/R), when augmented with the appropriate number of BLDs, it has up to 21 MP battalions (I/R). The ASCC, the TSC, and the MP brigade (I/R) must consider that the requirement to establish an MP battalion (I/R) internment facility is resource intensive. Therefore, MP I/R units, other supporting units, supplies, and equipment for the EPWs/CIs should arrive in theater ahead of the projected EPW/CI arrival at the internment facilities. Early arrival should be based on the time required to establish fully operational facilities (construct and man) and resupply operations before the EPWs/CIs arrive.

5-25. The MP battalion (I/R) has a command section, a company headquarters, and various staff sections. The staff sections provide the core battalion-level capabilities to conduct internment operations. The modulated design expands as the EPW/CI population increases. The battalion is assigned up to four detachments, two guard companies and, if needed, a processing squad. When fully operational, an MP battalion (I/R) operates an enclosure capable of interning 4,000 EPWs/CIs. The battalion mission centers on eight 500-man compounds. The battalion operates the compounds in close proximity to maximize its resources for the security and internment of the EPWs/CIs. This includes the resources needed to employ EPWs/CIs as a labor force according to the provisions of the Geneva convention.

5-26. Each MP detachment (I/R) (EPW/CI) operates two 500-man compounds and provides augmentation to the battalion staff sections to support 1,000 EPWs/CIs. Each guard company is capable of providing security for 2,000 EPWs/CIs. The guard company has a company headquarters and three platoons. The guard company requires sufficient mobility and communications to support routine battalion missions. While minimum mobility and communications is required to support EPW/CI internment operations, on-site guard personnel must often move considerable distances guarding labor groups performing work projects throughout the COMMZ.

5-27. The MP (EPW/CI) processing squad is capable of processing eight EPWs/CIs per hour and includes interpreters to support the processing. If processing squads are required to augment MP battalions (I/R), the operational requirements will be based on METT-TC.

MP-Battalion Resettlement Operations

5-28. The basic organization used for EPW/CI internment is used for resettlement operations. The primary mission-focus change is from guarding EPWs/CIs to protecting and controlling dislocated civilians. As such, an MP battalion (I/R) with four detachments and two guard companies is capable of supporting 8,000 dislocated civilians. However, the MP battalion (I/R) may require augmentation to conduct L&O operations associated with the resettlement. Augmentation may include the full scope of PM functions (operations, investigations, physical security, MP-station operations, and patrols) and civil affairs.

MP-Battalion Confinement Operations

5-29. When configured with the MP detachment (I/R) (confinement), the MP battalion (I/R) is capable of confining US military prisoners. The MP detachment (I/R) (confinement) provides trained corrections and support personnel required for confinement operations. As with the EPW/CI configuration, the modular confinement structure expands as the US prisoner population increases. With three confinement detachments and three guard companies, the MP battalion (I/R) has a maximum capacity of handling 1,500 US prisoners. Generally, only one MP brigade battalion (I/R) is configured for confinement, but the actual number will depend on the number of US prisoners requiring confinement within a theater. While theater policy for confinement operations remains with the ASCC commander, it is the MP brigade (I/R) that executes the mission.

5-30 When possible, soldiers awaiting trial remain in their units unless reasonable grounds exist to believe that they will not appear at the trial, the pretrial hearing, or the investigation or that they will engage in serious criminal misconduct. Under either of these two pretrial confinement instances, the commander must also reasonably believe that a less severe form of restraint (such as conditions of liberty, restriction in lieu of apprehension, or apprehension) is inadequate. When these circumstances exist and other legal requirements are met, US military personnel may be placed in pretrial confinement under the MP's direct control. Commanders may choose to establish field confinement facilities within their AO. However, corps and division MP companies have the expertise to operate only a field detention facility for a limited period of time. These units cannot operate a confinement facility and have neither the resources nor the capability to operate such a facility on an extended basis. Therefore, all confinement is consolidated in the COMMZ whenever possible.

5-31. All assets of the MP battalion (I/R) (confinement) are employed to detain, confine, sustain, and protect US prisoners. As with the battalions conducting EPW/CI and resettlement operations, the battalion conducting confinement operations is generally located in the rear of the COMMZ, near logistics and transportation support. This allows US prisoners to be moved as quickly as possible from the corps's area to the COMMZ's confinement facility. Movements of US prisoners from the COMMZ to CONUS will be according to DA policy.

Chapter 6

Military Police Support to Corps

Corps MP support their command by performing the MP functions critical to the success of their tactical commander's concept of operations

USAMPS

Corps are the largest tactical units in the US Army. They are the instruments by which higher echelons conduct operations at the operational level. Higher headquarters tailor corps for the theater and the mission for which they are deployed. They contain organic combat, CS, and CSS capabilities to sustain operations for a considerable period of time. Corps are capable of operating in a joint and multinational environment, providing C² for up to five divisions and covering up to 35,000 square kilometers.

OVERVIEW

6-1 MP support to a corps is provided by an MP brigade (CS) assigned to each corps. The MP brigade provides combat, CS, and CSS throughout the corps's AO. However, subordinate MP units are not assigned to subordinate corps units. Instead, the MP brigade commander gives them an AO based on the corps commander's concept of operations. When possible, MP battalion AOs coincide with those of the CSG RAOCs.

6-2 The corps MP provide combat power within the command's rear area. They perform combat operations to counter Level II forces and to support the defeat of Level III forces. When properly augmented, the MP brigade may serve as the corps's TCF. The corps MP also provide a critical link between MP operations in the division and in the COMMZ. The corps MP support division commanders by helping the division MP conduct sustainment operations. The corps MP coordinate with the division MP for mutual support.

THE MILITARY POLICE BRIGADE (COMBAT SUPPORT)

6-3 The MP brigade (CS) supporting a corps contains a brigade headquarters, up to six MP battalions (CS), numerous L&O detachments, and MWD teams. Each MP battalion (CS) has up to six MP companies (CS). As with the EAC's MP brigade (CS), the number of battalions and companies is determined by METT-TC. The corps MP brigade (CS) has additional companies to support each division and to provide security for the corps and COSCOM headquarters and corps ammunition storage areas (see Figure 6-1, page 6-2).

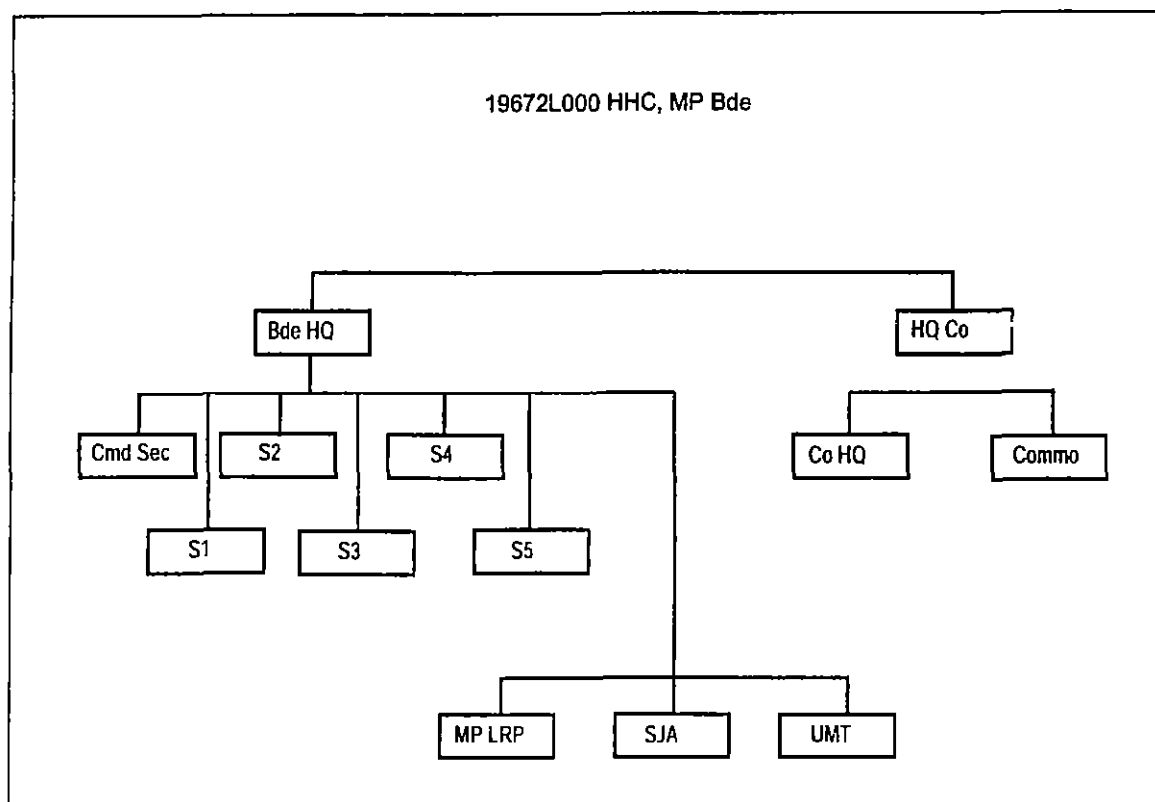

Figure 6-1 Military Police and USACIDC Organizations

6-4 The MP brigade HHC provides C² and A/L support to the brigade. The brigade HHC consists of a company headquarters and a brigade headquarters that contains the commander's immediate staff. The staff officers supervise the brigade's major organizational elements, including the—

- S1, S2, S3, S4, and S5
- MP long-range plans (LRP) section
- Communications section
- SJA
- IG
- Public affairs
- Unit ministry team (UMT)

6-5 The MP brigade (CS) command sergeant major (CSM) requires mobility and communications capabilities to execute his duties and responsibilities. The MP LRP section works with the corps G3 plans element, operating out of the corps main CP.

6-6 The MP battalion headquarters and headquarters detachment (HHD) provides C² for MP CS companies and any other assigned or attached MP elements. The battalion HHD consists of a detachment headquarters and a

battalion headquarters that contains the battalion commander's staff. The staff officers supervise the major organizational elements, including the—

- S1, S2, S3, and S4
- Communications and support sections
- UMT

6-7 As with the MP brigade (CS), the battalion CSM requires mobility and communications. The support section is vital to an MP battalion commander's ability to sustain his widely dispersed assigned or attached units during the performance of all five MP functions, primarily the MMS and AS functions.

6-8 The MP company (CS) provides support to an assigned AO. The company has a company headquarters, an MP operations center, a combat-medical section, and four platoons. The company headquarters provides maintenance, supply, communications, mess, and medical support to the unit. An MP operations center supports the unit's operation, conducting and planning for all five MP functions. The MP operations center includes three MP teams as the company-level response force.

6-9 The MP L&O detachments provide support to an assigned AO. The headquarters provides A/L support. The operation team plans and supervises desk operations, the traffic-accident and MP-investigation teams, and the force-protection teams. As with the EAC MP brigade (CS) detachments, requirements are based on the population supported and on METT-TC.

6-10 The number of assigned MWD teams is significantly less than those assigned to the EAC MP (CS) or (I/R) brigades. A kennel master, five explosive/patrol teams, and four narcotics/patrol teams are normally assigned to the corps MP brigade (CS). They are employed based on METT-TC.

COMMAND AND CONTROL

6-11 The C² in a corps MP brigade (CS) is consistent with that of any Army brigade. The MP brigade commander commands the brigade and all attached personnel. Battalion commanders work for the brigade commander. The MP company commanders receive their orders and work for their respective battalion commanders and direct their platoon leaders according to mission requirements.

6-12 When corps MP assets are sent to augment the division PM or the MP company, they are placed under the OPCON of the division PM for as long as the unit is needed in the division area. This command relationship is applicable to company-size organizations and smaller. If an MP battalion (or larger MP unit) augments the division, then the division PM will not exercise OPCON of that MP unit. The MP battalion will be placed OPCON as designated by the division commander but not under the division PM. One L&O detachment is normally attached to the supported division and placed OPCON to the division PM. However, MP leaders at each level establish an MP C² relationship based on METT-TC and the supported commander's needs.

EMPLOYMENT

6-13 Each corps MP brigade commander employs his assets according to METT-TC, the needs of the forces operating in his AO, and the priorities of the corps commander. Few MP assets in the corps area are employed to support fixed commitments. Instead, based on a broad consideration of the enemy and friendly situations, the corps MP are employed to support friendly forces engaged in combat, CS, and CSS operations. Since MP forces are dispersed throughout the corps area, the concentration of US forces, the location and vulnerability of critical sites, and the number of kilometers of the MSR to be controlled influence the designation of MP assets in the AO.

6-14 The MP brigade commander establishes his MP concept of operations based on the corps commander's concept of operations. His successful employment of MP assets depends on his foreseeing where the battle will be rather than where the battle is. Based on the rear-area IPB and PIAP, the MP brigade commander allocates and shifts resources to ensure the accomplishment of priority missions. This ensures the continuous support and forward sustainment of combat units and the safety of CSS units operating in the corps rear and sustainment areas.

6-15 To support the MP brigade commander's planning, the MP at brigade headquarters operate from several locations. Most of the staff locates in the vicinity of the corps rear CP where they can interface with the corps staff responsible for planning and executing rear operations. The control element of the brigade headquarters must be located where it can command and control its subordinate units. The brigade commander and his staff decide the best place to locate this element. The planning element of the headquarters locates near the corps main CP where it can interface with the corps commander's coordinating, special, and personal staffs. From there they monitor MP operations, integrate MP support with the corps plans cell for future operations, and learn the enemy situation through the G2's threat analysis almost immediately. The detailed information on rear-area activities and operations provided by the corps staff enhances the accuracy of the MP LRP.

6-16 The brigade S3 section provides the day-to-day planning and execution of an MP mission. The section provides a responsive CP that can relocate frequently throughout the AO. The S3 will normally provide liaison personnel to the corps rear CP, selected COSCOM units, interagencies, or other headquarters (based on mission requirements). When possible, battalion AOs coincide with the AOs of the CSG RAOCs. The MP brigade commander usually tailors battalions' AO boundaries to ensure responsive and flexible support across the corps's AO. He pays particular attention to the LOC behind the most heavily committed division and the critical bases and facilities in that area. He also ensures that the MP are available to respond quickly to combat operations throughout the entire corps rear area or during sustainment operations.

6-17 The MP brigade commander, coordinating with his battalion commanders, locates the MP companies where they can provide combat and CS power throughout the corps's AO. He bases his decision on the—

- Number and composition of urban areas

- Location of CS and CSS units
- Location of critical facilities (such as the headquarters, ammunition storage areas, and airfields)
- Expected threat
- Level and frequency of support needed by the commander
- Current and projected tactical situation
- MSR network, including choke points and critical bridges and tunnels
- Number of supported divisions and requirements

6-18 The prioritization of MP missions is especially crucial during the early stages of the deployment when it is unlikely that an MP brigade commander will have a full complement of CS companies. Augmenting the division MP company with corps MP assets may not be possible at that time. Until it is, the MP brigade commander must locate corps MP assets to help meet the needs of the division while fulfilling the needs of the corps.

6-19 Like the brigade commander, battalion commanders plan the employment of their companies and platoons using METT-TC. Certain corps needs are constant. One MP company is allocated to provide security for the COSCOM, and one MP company is allocated to provide security for the corps's main CP. One platoon from that company may be used to secure the corps tactical CP or the jump CP. One or more platoons will also help secure the corps's rear CP. The number of MP assets allocated for a corps-level EPW/CI holding area and escort is based on METT-TC. However, a minimum of one platoon is dedicated to operate the corps's EPW/CI holding area and a minimum of one platoon per division is allocated for evacuating EPWs/CIs from division collection points. Additional MP assets may be allocated to provide security for the corps's ammunition storage area and ASPs supporting the divisions. The MP battalion commander places his companies where—

- MP assets support the brigade commander's concept of operations
- The MP can support troop concentration, bases and base clusters, road networks, and critical areas
- The MP can aggressively patrol critical terrain and monitor LZs and DZs to detect or deny enemy interference
- The MP can respond to Level II threats
- The MP can support the movement of combat resources throughout the AO
- The MP can remove EPWs/CIs from division collection points
- The MP can influence stragglers, refugees, and dislocated civilians

6-20 Battalion commanders may choose to place a company behind the division rear boundary. This can help to ease the coordination between the corps MP and the division MP.

Chapter 7

Military Police Support to Division

Division MP provide essential support to the forward tactical commander. The MP provide a flexible, mobile, and lethal force ready to be employed in combat or CS operations.

USAMPS

The division is a large Army organization that trains and fights as a tactical team. Largely self-sustaining, it is capable of independent operations. The division is a unit of maneuver organized with varying numbers and types of combat, CS, and CSS units. Divisions fall mainly into two categories—heavy or light. The first category includes heavy divisions, their variants, and the Division XXI digitized heavy division. The second category includes the light infantry, airborne, and air-assault divisions. Each division can conduct operations over a wide range of environments. The success of Army operations depends on the success of its divisions.

OVERVIEW

7-1 In corps operations, divisions are normally comprised of three maneuver brigades, each with up to nine maneuver battalions, artillery battalions, aviation battalions, and supporting CS and CSS units. Divisions perform a wide range of tactical missions and are self-sustaining for limited periods of time. The corps augments divisions as the mission requires. All divisions must be able to deploy and conduct offensive, defensive, stability, and support operations. Airborne and air-assault divisions must be able to conduct forced-entry operations. Divisions may be part of a JTF or serve as the ARFOR headquarters.

7-2 MP support to a division is provided by an organic MP company that includes the PM and his staff (assigned to each division) and is augmented by the corps MP brigade. The division MP company provides support in the DRA and in the maneuver brigade rear area. It is fully mobile in order to relocate frequently under short notice. While division MP companies are capable of performing all five MP functions, they must be augmented by corps MP/CID to fully perform all five MP functions throughout the division's battle space. The division PM must receive at least one corps MP company for GS missions in the DRA, one L&O detachment for L&O missions, and one CID detachment for criminal investigations and LOGSEC. In a mature theater (or based on METT-TC), the division PM can expect two corps MP companies. In addition, the division PM may request a corps MP battalion headquarters to provide C² to corps MP units operating in the DRA or to perform missions as a TCF. Because the need for MP support exceeds division organic assets (and many

times exceeds augmenting corps MP assets), careful planning of MP employment is essential

DIVISION MILITARY POLICE COMPANY

7-3 The organization of the division MP company is set by specific tables of organization and equipment (TOE) and is designed to support a specific type of division. Regardless of the type of division, the assets in a division MP company enable a PM and his supporting staff to supervise the performance of all five MP functions. The PM coordinates the employment of the MP assets in the division's AO through his PM section. The division MP company contains a headquarters, a PM section, a medic section, and three to six platoons.

COMMAND AND CONTROL

7-4 The C² of the division MP company extends downward from the tactical commander to the division PM. The division PM is the division commander's special staff officer. Under normal circumstances, he works for the chief of staff. The division PM has OPCON of the division MP company and MP assets that have been provided by the corps. The division PM plans and employs all of the organic, assigned, or attached MP according to METT-TC. He anticipates the support needs of the division commander and plans the employment to meet his needs. After learning the division commander's concept of operations and estimating the situation, the division PM decides which MP functions are critical to accomplish the commander's mission. He then recommends the allocation of resources, tasks his assets, and establishes the priority of support.

7-5 When the division MP company is augmented by corps MP platoons, the platoons are placed under the direction of the division MP company commander, who assigns an AO to each platoon. When corps MP assets augmenting the division make up a company, the company is attached to the division. The company then comes under the OPCON of the PM, who assigns it an AO. The augmenting corps MP company is usually given an AO from the division rear boundary forward. However, this assignment is flexible and based on the division commander's needs as set forth by the division PM. The four platoons of that corps MP company perform all five MP functions in that AO. Additionally, the corps MP brigade (CS) L&O detachment supporting a division is attached to the division and OPCON to the division PM.

7-6 The division MP company commander directs the employment of company assets. Through his company headquarters, he provides administrative, maintenance, and logistical support to the PM section and to the company's platoons that are dispersed throughout the division's AO. These sections are mobile to support the platoons without delay despite the extended distances that may be separating them. The company commander is also mobile. He travels the extended distances from one platoon area to another when checking on the status of his soldiers and resolving the problems affecting mission accomplishment. The division HHC provides mess support. Personnel administration is handled by the company headquarters and the DISCOM. The number and kind of assets in a division MP company and the configuration of its platoons and squads are determined by the type of division to which the company is assigned.

NOTE: See the consolidated TOE update that is published yearly for complete details (base and objective) for all MP TOEs.

7-7 At the direction of the division commander, the division band may be available to perform its secondary mission of supporting MP operations. When the intensity of the conflict prevents the band from performing its musical mission, the division commander may direct it to augment the MP company. The band, normally employed as a unit under the direction of the bandmaster, is under the OPCON of the MP company commander while augmenting the MP. When tasked to augment MP assets, band members may be employed to augment MP security at the division main CP or to augment perimeter security at the division EPW/CI collection point. The band is released to perform its primary mission as soon as the tactical situation permits.

MILITARY POLICE EMPLOYMENT

7-8 The employment of division MP companies differs somewhat with the type of division to which they are assigned. In heavy divisions, the division MP companies provide GS to the DRA and DS to the division's maneuver brigades. When the platoon is providing DS to a maneuver brigade, the MP platoon leader coordinates all logistical support with the supported brigade. A platoon's DS relationship is seldom interrupted. However, METT-TC may require weighing MP support to the maneuver brigade tasked as the main effort or employing all platoons in a division MP company to function as a unit (such as during division-size river-crossing operations or deliberate breaching operations). In light divisions, the MP provide only GS to the DRA or during sustainment operations. Support exceptions are addressed under MP support to airborne and air-assault divisions, discussed later in this chapter.

7-9 In the division (where flexible support of an austere force is crucial), the division PM must have a clear understanding of situational awareness. To obtain current information for projecting MP needs in the division area, he must be mobile and be able to conduct split-cell operations. The assets available to the PM include the division MP company and at least one corps MP company. Corps augmentation is required for sustained operations and for special operations such as river crossings, dealing with dislocated civilians, and refugee internment or resettlement. The division PM coordinates with the corps PM and the MP brigade or CID commanders for—

- Evacuating and guarding EPWs/CIs from division to corps
- Providing law-enforcement assistance to HN forces in the division's AO
- Providing corps augmentation for the division's AO, convoy security, LOC security, AS, R&S, L&O, and other missions. These other missions may include augmentation for security of the division main CP, ASPs, and other critical facilities.
- Integrating, sharing, and exchanging police intelligence between corps and division MP elements
- Providing CID support

SUPPORT TO THE HEAVY DIVISION

7-10 The Army's armored and mechanized infantry divisions (normally referred to as heavy divisions) provide mobile, armor-protected firepower that is normally employed for their mobility, survivability, lethality, and psychological effect (shock) on the enemy. These divisions destroy enemy armored and mechanized forces, and they can seize land areas and secure key terrain. Because of their strategic lift requirements, heavy divisions are slow to deploy from home staging bases into an AO. They have high consumption rates of supplies and have limited use in restrictive terrain. These capabilities and limitations are key factors in planning effective and efficient MP support throughout the division's AO.

7-11 In the heavy divisions, the PM section is organized to support split-cell operations at the main and rear CPs. The PM must be mobile to ensure that he is fully aware of the current status of critical MP operations. Therefore, the deputy PM (DPM) locates in one of the PM cells and—

- Handles the section's routine operations
- Monitors ongoing division operations and MP support
- Helps provide long-range planning and interface with the primary division staff
- Forwards PM taskings to the division MP company commander

7-12 The DPM and the operations sergeant normally set up operations at the division main CP where they can coordinate requirements with the division staff personnel. The company headquarters is initially located near the division rear CP in the division support area (DSA). Once augmentation arrives from the corps, the headquarters relocates with one of its GS platoons operating behind the brigade rear boundary. However, this location could be changed based on METT-TC, the supported commander's needs, and the company commander's idea of where he can exercise better C² for his unit.

7-13 The Army of Excellence (AOE) heavy division MP company has six platoons. Three platoons provide support to each maneuver brigade and are designated as DS. The other three platoons are designated as GS platoons. One MP platoon provides security for the division main CP, one provides security for the division's EPW central collection point, and one performs other MP operations within the division rear.

7-14 The GS MP platoons' AOs are configured based on METT-TC and the availability of MP augmentation from the corps. The DS MP platoons' AOs coincide with the supported maneuver brigade's boundary. Each platoon headquarters locates within its brigade's support area or any other area where it can best provide and receive support. To accomplish its mission, each DS platoon requires a minimum of two squads, each with three teams. One squad operates the EPW/CI collection point. The other squads perform MMS and AS operations. All MP platoons are capable of performing all five MP functions. However, performance of these functions is prioritized based on METT-TC and the division commander's concept of operations. The division PM, the company commander, and METT-TC dictate how these platoons should be tasked-organized to accomplish the mission.

SUPPORT TO THE LIGHT INFANTRY DIVISION

7-15 The AOE light infantry division (LID) is one of the most rapidly and strategically deployable divisions. It fights as part of a larger force in war or conducts missions as part of a joint force in MOOTW. Its C² structure readily accepts any augmentation forces, permitting task-organizing for any situation. The augmentation required for the division is largely determined by METT-TC. The division's capabilities allow it to exploit the advantages of restricted terrain and limited visibility. It achieves mass through the combined effects of synchronized small-unit operations and fires rather than through the physical concentration of forces on the battlefield. These characteristics are key factors in planning and employing MP assets in support of the LID.

7-16 The LID MP companies are capable of performing all five MP functions. However, their performance of these functions is prioritized based on METT-TC and the division commander's concept of operations. Contrary to the heavy division MP company, the LID MP companies are much smaller. The constrained size of the LID MP companies makes corps MP augmentation crucial to the sustainment of MP operations. Additionally, the LID MP company is the only MP unit with the capability of antiaircraft support through the use of shoulder-fired air-defense weapons.

7-17 The company has three GS platoons to support the division. No platoons are provided to the maneuver brigade. One platoon is normally located in the vicinity of the division main CP so that its resources can help support CP security. Another platoon locates in the DSA and operates the division EPW/CI collection point. The last platoon has an AO configured according to METT-TC and the commander's priority of MP missions. Each GS MP platoon has a headquarters and three squads, each with two teams. The PM section is located in the vicinity of the division main CP. The exact location is based on the current operational status and on METT-TC.

SUPPORT TO THE AIRBORNE DIVISION

7-18 The AOE airborne division can rapidly deploy anywhere in the world to seize and secure vital objectives. It conducts parachute assaults to capture initial lodgments, executes large-scale tactical raids, secures intermediate staging bases (ISBs) or forward operating bases (FOBs) for ground and air operations, and rescues US nationals besieged overseas. It can also serve as a strategic or theater reserve as well as a reinforcement for forward-presence forces. The airborne division can assault deep into the enemy's rear area to secure terrain or to interdict enemy supply and withdrawal routes. It can seize and repair airfields to provide a FOB and airheads for follow-on air-landed forces. It is capable of all other missions assigned to LIDs. The airborne division does not have sufficient armored protection to defeat heavier armored formations at close range. Therefore, engagements with enemy armored formations require special considerations. Antitank weapons in the division compensate for, but do not completely offset, this deficit.

7-19 Airborne divisions conduct operations in two phases—assault and defense. The division accomplishes the assault phase in three stages. First,

they deploy, second, they establish the airhead, and third, they extend the logistics base and build their force

7-20 Like other division MP companies, those assigned to the airborne division are employed to support their division commander's concept of operations. The airborne MP company has four platoons, each having three squads with two teams. Normally, the company headquarters and one of the platoon headquarters collocate with the PM section. The division PM's exact location depends on METT-TC. During the assault phase, the airborne division MP company provides DS to the assault brigade. The remaining platoons provide MMS and AS in the vicinity of the division main CP.

7-21 The nature of airborne operations makes the capture of EPWs likely. Therefore, during the first stage of the assault phase, the priority of MP support is given to EPW operations. After assembling the DZ or LZ, the MP collect EPWs captured during the assault. Combat elements are relieved of EPWs as far forward as possible. In airborne operations, EPWs are held for later movement to a central collection point. During the first stage of the assault, the MP perform limited straggler and refugee control and undertake AS operations, when possible.

7-22 MP support is reevaluated after the airhead is established in the second stage of the assault. The PM takes in consideration personnel and equipment flow, roadways, and security requirements to shift MP support priorities. As the entire operation matures, MP support may expand to include all five MP functions.

SUPPORT TO THE AIR-ASSAULT DIVISION

7-23 The air-assault division executes tactical missions at operational depths to achieve strategic results. It is capable of launching brigade-size air assaults of nearly 4,000 soldiers from either an ISB or a tactical assembly area (TAA). Within 6 hours, this air-assault task force (AATF) can attack an opposing force, occupy and defend key terrain, or establish a FOB (out to 150 kilometers) from which even deeper operations can be executed. Air-assault operations are terrain independent, but they rely on suitable weather and a detailed attrition/assessment of enemy capability—particularly air-defense assets along air corridors and in the objective area. The air assault is preceded by detailed, lethal and nonlethal condition settings, culminating in a comprehensive condition check before execution.

7-24 As the corps AATF unit, the brigade combat team (BCT) task-organizes and habitually trains with both aviation lift and attack (Apache) battalions. An air-assault division MP company has four platoons, each having three squads with two teams. To facilitate operations, air-assault division MP platoons are habitually aligned with each of the three AOE BCTs, however, as with aviation assets, the MP are task-organized to support the main effort's BCT/AATF. When conducting these operations, two MP platoons may be tasked to provide support, one is available to posture and participate in the air assault, and the other conducts AS and MMS operations at the pickup zone (PZ). This second MP platoon may further provide MMS and accompany a ground-assault convoy (GAC) to the objective, or it may remain at the PZ to receive EPWs returning on aircraft from the objective area. The mission of

conducting MMS along this vulnerable ground LOC is particularly critical if the AATF objective is a FOB from which further division operations will expand

7-25 MP participation in the actual air assault competes for heavy lift with FA and air-defense systems, as well as with vital Class V resupply. However, the lethality and versatility of the MP bode well for their employment, and two MP platoons are available to support the brigade air assault as the division's center of gravity.

7-26 When possible, habitually aligned platoons remain with their brigades, and corps assets perform GS missions. However, when no corps assets are available and two division platoons are employed as stated above, the two remaining platoons conduct division EPW collection-point operations and other MP functions based on METT-TC. Normally, the EPW platoon and the MP company headquarters collocate in the DSA. As required (and based on METT-TC), airflow planning includes EPW/CI evacuation from the AATF/FOB collection point back to the DSA. The PM section operates from the division rear CP to facilitate I/R operations and to coordinate MMS and AS with key logistical staff. Due to potentially extreme distances on the air-assault battlefield, the DPM normally locates with the division main CP to serve as a key G3 battle-staff member and to coordinate PIO with the G2.

SUPPORT TO DIVISION XXI (HEAVY DIVISION)

7-27 Division XXI represents a significant change in the manner in which division operations are conducted. These changes are brought on by information-age capabilities, an increased integration of service components into an effective battle team, more lethal, survivable, and agile systems, and more capable soldiers and leaders. The Division XXI operates in a larger battle space and at a higher tempo than the AOE division. The division is evolutionary in design, but revolutionary in its use of information technology. It improves the Army's deployability while enhancing its ability to dominate in decisive fights. The following are characteristics of the Division XXI operational environment:

- **Multidimensional.** The division will operate in an extended battle space that goes beyond the traditional physical dimension of width, depth, and height. It includes portions of the electromagnetic spectrum, and it extends beyond the physical boundaries of the division through its communication and digital connectivity to other Army, joint, and coalition elements, even reaching back to CONUS.
- **Precise.** Precision operations go beyond a precision strike to include every aspect of military operations from deployment through combat and through redeployment or transition to other operations. Precision in decisive operations is enabled by three emerging capabilities. First, digitization provides soldiers and leaders at each echelon the information required for making decisions. Second, a full suite of strategic, operational, and tactical sensors linked to analytical teams fuses combat information into situational awareness across the battle space. Third, simulations enable Army elements to be tailored and operations to be planned, war-gamed, and rehearsed—yielding precision execution.

- **Nonlinear.** Nonlinear operations do not seek a battle-space grid of close, deep, and rear operations. Instead, the battle space is fluid, changing as METT-TC changes through the duration of mission preparation and execution. Another dimension of this characteristic is the synchronization of near-simultaneous operations to achieve nonlinear effects across the battle space.
- **Distributed.** Division operations are distributed or executed where and when required to achieve decisive effects concentrated at a decisive point. Dispersion empowers subordinates to operate independently within the commander's intent, leading to synergistic effects that exceed the effects of a centralized headquarters.
- **Simultaneous.** The concept of decentralization operations that are multidimensional, precise, distributed, and nonlinear yields the capability to conduct simultaneous operations across the battle space. Simultaneous operations seize the initiative and present the enemy leadership with multiple crises and no effective responses. Rather than a single, concentrated attack, the division executes a series of attacks (lethal and nonlethal) as simultaneously as possible.
- **Integrated.** Division operations are fully integrated with joint, multinational, and nongovernmental partners. Integrated operations enable the Army to leverage the full suite of capabilities that the services bring to the battle space.

7-28 The Division XXI heavy division is one of total integration—not rounding up or down. Reserve-component soldiers assigned to the division are an integral part of the division mission and task accomplishment. The division cannot operate without them. The division is focused on massing effects on the enemy—enabled by a new foundation of information technology and distributed logistics. The division is built around the pattern of "conduct decisive operations," accomplished by either fires or maneuver. The design performs complementary battle-space shaping in concert with the overall corps plan. Its long-range assets are not typically held in reserve nor just employed in the close fight; they are used to best support the corps and division commanders' plans of operations.

7-29 Although the basic structure of the division has not changed—three maneuver brigades, a division artillery, and a DISCOM—the internal structure and operational construction have changed in a near revolutionary way. The C² structure and the basic organizational structure are very similar to the divisions discussed above. However, by integrating the capabilities of digital technology and by using enhanced situational awareness, it is better able to execute combat operations.

7-30 The maneuver brigades have their own scouts—a brigade reconnaissance troop (BRT), therefore, they no longer rely exclusively on the battalion scouts. The maneuver battalions are reduced to three companies with a total number of 45 combat platforms. The division artillery has three Multiple-Launch Rocket System (MLRS) batteries per battalion. The cavalry squadron is under the aviation brigade's C² but retains and performs the division's traditional cavalry mission. Figure 7-1 depicts the organizational structure of Division XXI.

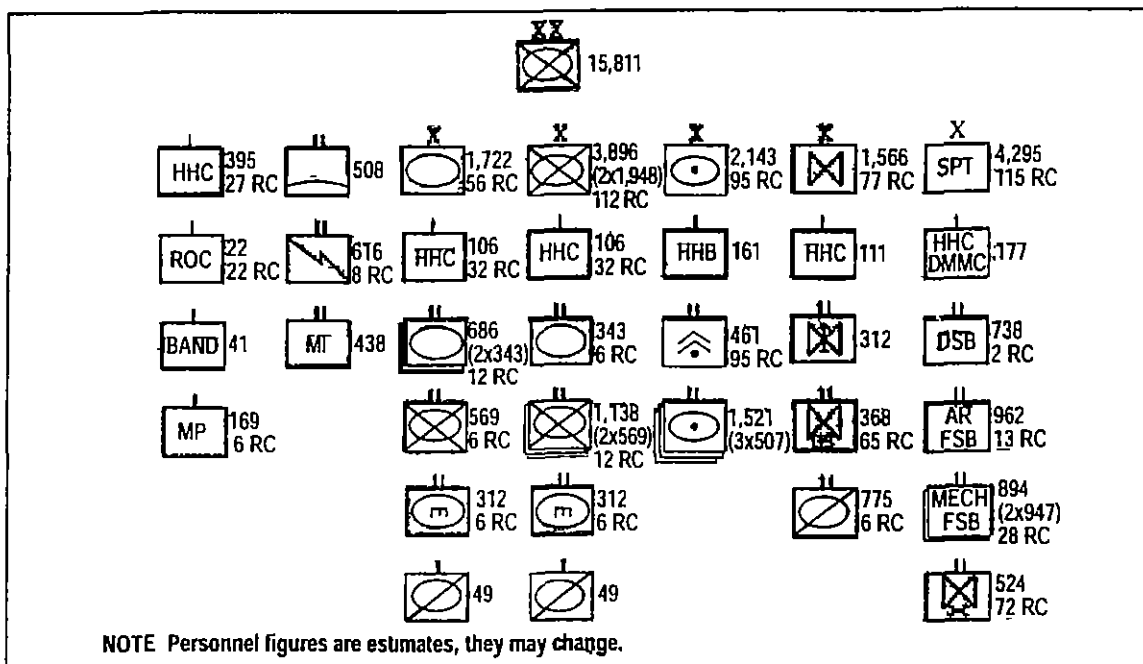

Figure 7-1 Division XXI Structure

7-31 The division's CSS is centralized. Instead of each unit having its own organic CSS personnel, they are now centralized in CSS units. The CSS assets are reorganized and reassigned to the DISCOM. Forward-support companies (FSCs) are habitually associated with each maneuver battalion and forward-support battalions (FSBs) will support each maneuver brigade. This operational structure enables distribution-based rather than supply-based logistics concepts to support the division. The overall logistics footprint for the division is now reduced and the division has organic self-sufficiency to operate unsupported for up to 30 hours.

7-32 A major difference between the AOE fix-forward doctrine and the Division XXI maintenance support is the change in the actual repair site. Division XXI maintenance units directly supporting a given customer will diagnose faults and will replace components forward in the battlefield and will repair rearward. Units will be manned with maintenance personnel capable of performing DS and limited GS maintenance.

7-33 The division operates in a battle space two and a half times larger than an AOE division, and it will usually fight as part of a corps or a JTF. The division conducts offensive, defensive, stability, and support operations in cooperation with other elements of the corps/JTF to gain tactical or operational results significant to the joint-force commander's campaign goals.

7-34 Although the division is a heavy division, MP support is somewhat different from that of an AOE heavy division. The PM (based on METT-TC) establishes operations where MP assets can best be commanded. At the same time, overall MP operations can be synchronized to support operations within

the division rear and the division commander's intent can be effectively supported. To this end, the PM conducts split-cell operations within the division main CP. Normally, the PM section is distributed between the security-operations cell (SOC) and the mobility/survivability (M/S) cell. The DPM (who works out of the M/S cell) is also part of the division planning team. He ensures that MP operations are integrated into division plans according to the PM's intent. The DPM attends coordination meetings and assumes coordination responsibility with the rest of the division staff when the PM relocates away from the division main CP.

7-35 The PM, as a staff officer, is involved with every aspect of planning and with the military decision-making process (MDMP). He uses the Force XXI Battle Command—Brigade and Below (FBCB2) C² system to understand the battlefield. He understands the mission and the commander's intent and priorities. The PM has complete situational awareness, establishes an effective staff relationship with the G3, and recommends the best way to employ MP resources.

7-36 The Division XXI heavy division MP company has five platoons. Although tasked-organized based on METT-TC and the commander's needs, three MP platoons provide DS for each maneuver brigade. The DS platoon requires a minimum of three squads (each having three teams) to accomplish the mission. The other MP platoons are normally employed forward in sector, providing AS and force protection for the division main and tactical (TAC) CPs and for other HVAs in the vicinity of the maneuver brigade rear boundary. As with the AOE heavy division, the Division XXI heavy division requires augmentation with at least one corps MP company for CS missions in the DRA and can expect two companies in a mature theater (based on METT-TC) as the main effort. In addition, the division may request an MP battalion headquarters to command and control CS MP operations in the rear or to conduct TCF operations.

7-37 While the division MP company is capable of performing all five MP functions, it must be augmented by the corps MP to fully perform all of these functions throughout a mature division's battle space. The PM prioritizes MP functions (based on the supported commander's needs), conducts a mission analysis, and requests needed corps assets through the division G3. Corps MP companies, L&O detachments, and CID assets are needed for sustainment operations. When corps MP companies and L&O detachments are attached to the division, they are placed under OPCON of the PM. The PM will then assign an AO and missions based on METT-TC.

7-38 The PM supports the division's distribution-based logistics concept by conducting aggressive R&S operations that secure the LOC. Since the main effort is to secure the LOC, traditional MMS missions (such as convoy security and escorts) are performed by exception. Through the allocation of increased MP to conduct LOC R&S operations aggressively, the division is able to detect and destroy threat forces before they interrupt operations in rear-area or sustainment operations.

7-39 Digitization gives the division the situational awareness that allows it to cover much larger distances and to move much faster. The systems that

provide this digitization are generally unprotected HVAs on the battlefield, which require aggressive AS and force-protection operations

7-40 The EPW operations are much more fluid, sometimes requiring the division GS MP to move forward and assume brigade collection points, thus allowing DS platoons to move forward with their brigades. Similarly, corps MP may be required to move forward and assume the division's central collection points as the division's rear boundary is pushed forward to shorten the LOC

7-41 As with all AOE divisions, until corps L&O and CID detachments augment the division, L&O operations are on an exception basis. The MP collect intelligence during every facet of mission execution. The PM develops police intelligence in the division main CP through coordination with the SOC, the G2, the Assistant Chief of Staff, G5 (Civil Affairs) (G5), and the Assistant Chief of Staff, G6 (Communications) (G6)

Chapter 8

Separate Brigades and Initial/Interim Brigade Combat Teams

The MP support separate brigades and IBCTs designed to provide the brigade commander with MP assets that can serve as a force multiplier and that can be employed as an economy of force. The brigade MP platoon is as lethal, flexible, and capable as any other platoon in the MP Corps.

USAMPS

The Army uses separate brigades to inject a small but powerful force where it is needed. It must be able to fight and win while operating on its own for a sustained period of time. It must be able to defend itself on a 360-degree front in war or MOOTW. While there are some variations of separate brigades, it is the heavy separate brigade that is most commonly found within the force.

OVERVIEW

8-1 The Army's IBCT is a full-spectrum, wheeled combat force. It is employed in all operational environments against all projected future threats. However, it is designed and optimized primarily for employment in small-scale contingency operations in complex and urban terrain, confronting low-end and midrange threats that may employ both conventional and asymmetric capabilities. The IBCT deploys very rapidly, executes early entry, and conducts effective combat operations immediately on arrival to prevent, contain, stabilize, or resolve a conflict through shaping and decisive operations. The IBCT participates in war (with augmentation) as a subordinate maneuver component within a division or a corps and in a variety of possible roles. The IBCT also participates (with appropriate augmentation) in stability and support operations as an initial-entry force or as a guarantor to provide security for stability forces by means of its extensive capabilities.

SUPPORT TO SEPARATE BRIGADES

8-2 MP support to separate brigades is provided by a four-squad MP platoon organic to the brigade HHC. A separate PM cell within the brigade HHC serves as the C² element for the platoon (see Figure 8-1, page 8-2). Support to the platoon and the PM section for maintenance, supply, mess, and communications is provided by the brigade HHC. Since the platoon and PM section have no organic support, the MP leadership must perform close coordination for this support. However, the MP platoon must compete with other brigade HHC assets for priority of repair for weapons, vehicles, and communications equipment.

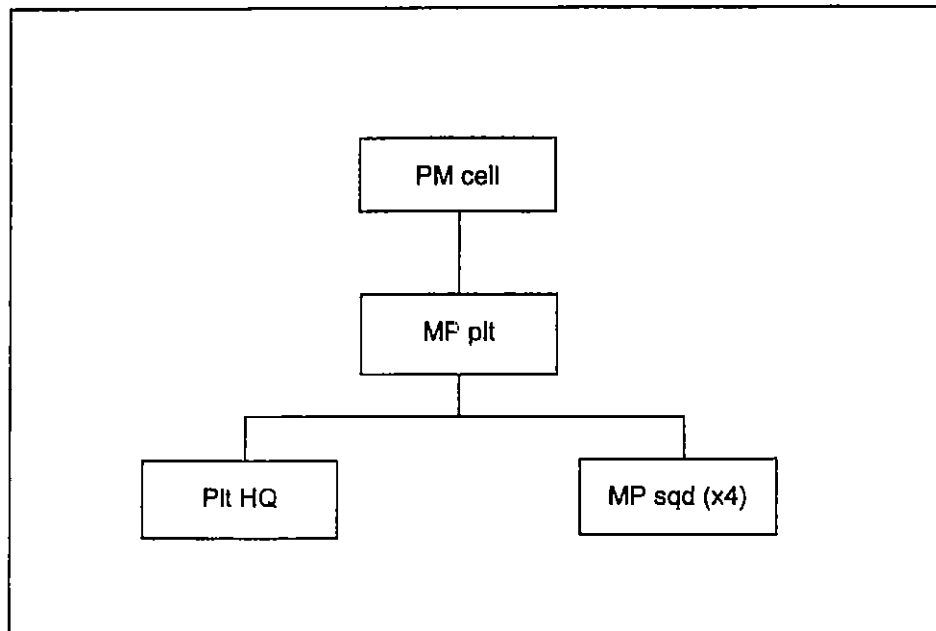

Figure 8-1 MP Support to a Separate Brigade

8-3 The C² of an MP unit supporting separate brigades also extends down from the tactical commander. The separate brigade PM has OPCON of brigade MP assets the same way the division PM has OPCON of division MP assets. This includes any MP assets that may have been provided from the corps. The PM advises the commander of a separate brigade on matters pertaining to MP operations. The platoon leader directs the execution of his platoon's mission based on the priorities set forth by the PM and the supported commander. Since the separate brigade's organic MP platoon is more robust than an MP platoon supporting a division maneuver brigade, METT-TC will determine the requirement for augmentation. However, corps L&O and CID augmentation is required.

8-4 The separate brigade's MP platoon is capable of performing all five MP functions. However, its resources are quite limited. Although the MP squads are employed according to METT-TC, the platoon supporting the separate brigade may have—

- One squad operating in the EPW collection point
- One squad providing a mobile security screen and providing AS around the brigade's main CP
- Two squads conducting MMS and AS throughout the brigade's rear area

SUPPORT TO THE INITIAL/INTERIM BRIGADE COMBAT TEAM

8-5 The IBCT is a divisional brigade. It is designed to optimize its organizational effectiveness and to balance the traditional domains of lethality, mobility, and survivability with the domains required for responsiveness, deployability, sustainability, and a reduced in-theater

footprint. Its two core qualities are its high mobility (strategic, operational, and tactical) and its ability to achieve decisive action through a dismounted infantry assault. The major fighting components are its motorized infantry battalions. The IBCT has a unique reconnaissance, surveillance, and target acquisition (RSTA) squadron to enhance situational understanding.

8-6 To achieve a rapid deployment threshold, the brigade's design capitalizes on the widespread use of common vehicular platforms—particularly a highly mobile, medium-weight, combat/CS platform coupled with the minimization of the personnel and logistical footprint on theater. Encompassing a personnel strength of about 3,500 and preconfigured in ready-to-fight combined-arms packages, the entire IBCT can deploy within 96 hours of "first aircraft wheels up" and begin operations immediately upon arrival at the APOD. In essence, the APOD is the TAA. The IBCT cannot conduct forced-entry operations, but it provides the JFC with an improved capability to arrive immediately behind forced-entry forces and begin operations to shape the battle space and to execute decisive action to expedite decisions. Once committed, the IBCT can sustain operations for up to 180 days without relief.

8-7 The IBCT's organization is expandable either through augmentation or scalability (according to METT-TC) in any given contingency. The IBCT is scalable in terms of its ability to accept like-type additional forces to expand core tasks and functions already resident within the IBCT (for example, adding additional infantry or RSTA organizations). The IBCT is also capable of accepting augmentation consisting of units or elements that execute tasks or functions not resident within the IBCT (for example, adding armor, air-defense, MP, or aviation assets). In both cases, added units execute their normal mission-essential task list (METL) tasks and, therefore, will not require extensive training to deploy and operate with the IBCT. In both cases, the IBCT includes the command, control, and communications (C³) capabilities necessary to permit the rapid integration of additional enabling capabilities, particularly for operations outside the scope of small-scale contingency operations (such as stability operations, support operations, and war).

8-8 The IBCT organization excludes other unit-based capabilities often provided in a division slice. However, for each missing capability, the brigade headquarters includes staff cells capable of conducting rudimentary planning and analyses to ensure that all functional-area considerations are incorporated in route planning and preparation for operations. The first MP elements in support of the IBCT are at the brigade headquarters level.

8-9 The MP planning cell is composed of a two-person (a major [MAJ] and a sergeant first class [SFC]) planning cell located within the HHC's maneuver-support cell and under the direct staff supervision of the brigade S3. The role of the MP planning cell is significantly different from that of a traditional division PM or a separate brigade PM. The main difference is in the IBCT's lack of organic or habitual MP assets. However, the absence of organic MP assets makes the job of the MP planning cell that much more critical. The MP planning cell must—

- Understand the organization, capabilities, and limitations of the IBCT.

- Conduct effective liaison with higher headquarters PM elements
- Become an effective planner and anticipator of MP requirements
- Prepare MP staff estimates and employment recommendations
- Plan for MP deployment via air, sea, rail, or land
- Task-organize MP units effectively and efficiently
- Assume C² of incoming MP forces or, if operating under a division or corps, relinquish C² to the division/corps PM or battalion commander (if appropriate for effective employment of MP forces)

8-10 Depending on METT-TC, the brigade may be augmented by MP elements ranging from a platoon to a battalion. In any case, the MP planning cell then becomes a staff planner and coordinator of functional matters pertaining to—

- Force protection, physical security, and vulnerability countermeasures
- Operations for collecting, processing, and evacuating (possibly) EPWs, CIs, and detainees
- US military prisoner operations
- Operations for processing and controlling dislocated civilians and refugees
- Customs and counterdrug operations
- Criminal investigations and CID-/MP-investigator support
- PIO and establishing links with HN police agencies and other international/interagency law-enforcement agencies
- MMS, AS, and L&O operations
- Coordination of MP or CID division/echelons above division (EAD) augmentation forces, MWD teams (explosives, narcotics, and patrol), L&O detachments, and MP I/R units through the division, corps, and major Army command (MACOM) PMs
- Training guidance to other US forces required to perform MP functions in the absence of MP forces

8-11 Since the IBCT is a divisional brigade, the division PM and the IBCT MP planning cell play an important role in developing an optimum MP force package to support the brigade commander's concept of operations. Despite the brigade's early-entry timelines, the MP planning cell must consider and plan for MP augmentation forces as early as possible to free valuable combat resources. Small-scale contingency operations that result in numerous EPWs, civilian detainees, and refugees will hamper momentum and freedom of maneuver.

8-12 Once the initial brigade receives MP augmentation (see Figure 8-2), the MP priority of effort during the offense will focus on ensuring that routes remain unencumbered and secure for movement of ground combat, CS, and CSS forces. The MP's priority of effort during the defense will focus on conducting AS and counterreconnaissance along the LOC, C² centers, and CSS bases. The MP may conduct response-force operations or become part of the TCF.

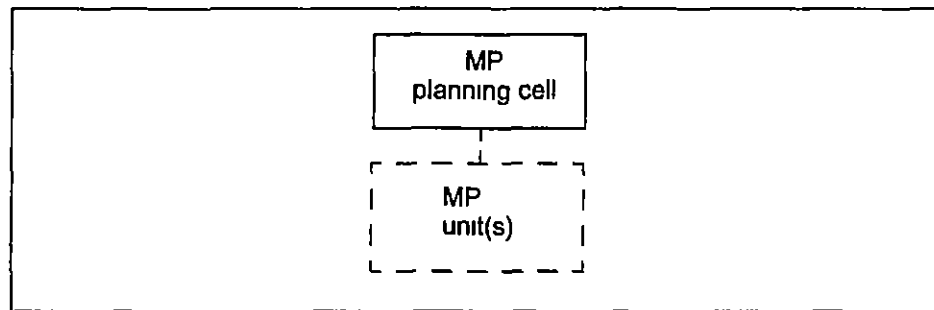

Figure 8-2. MP Support to the IBCT

8-13 Stability and support operations present some unique challenges. The IBCT may be deployed to a geographical area that is politically unstable, that lacks civil control, or that is in complete turmoil. The MP planning cell plans for and coordinates MP support according to available resources and the supported commander's needs. In this scenario (and based on METT-TC), an MP battalion TF could be required to deal with the challenges of—

- A significant number of refugees or dislocated civilians
- AS or force-protection issues
- MMS operations
- Black-market and criminal investigations
- Restoration of order
- Civil unrest
- Intervention of private and nongovernmental organizations

Chapter 9

The United States Army Criminal Investigation Command

The history of the USACIDC goes back to World War I, when General John J. Pershing organized the CID in France. Today, the USACIDC is the Army's sole agent responsible for investigating felony crimes on and off the battlefield. The USACIDC provides investigative support to commanders at all echelons.

USACIDC

The USACIDC investigates offenses committed against US forces or property, or those committed by military personnel or civilians serving with US forces or where there is a military interest. The USACIDC agents investigate violations of international agreements on land warfare. They conduct special investigations at the direction of the USACIDC's commanding general (CG) or a higher authority. In general, the USACIDC's missions include—

- Investigating and deterring serious crimes
- Conducting sensitive/serious investigations
- Collecting, analyzing, processing, and disseminating criminal intelligence (CRIMINTEL)
- Conducting protective-service operations for designated personnel
- Providing forensic-laboratory support
- Maintaining Army criminal records
- Enhancing the commander's crime-prevention and force-protection programs
- Performing LOGSEC operations

OVERVIEW

9-1 The USACIDC's operations help the commander maintain discipline and order by preventing or investigating crimes that reduce a unit's ability to fight. During the investigation of serious crimes, the USACIDC concentrates its efforts on investigating serious crimes such as wrongful deaths, controlled-substance offenses, theft, fraud, sex crimes, and assaults. The USACIDC also conducts sensitive and special investigations involving matters pertaining to senior Army officials and those associated with classified programs.

9-2 The USACIDC agents collect, analyze, process, and disseminate criminal intelligence/information relating to crime within or directed toward the Army. Specific information relating to modus operandi, crime techniques, investigative leads, gang violence, and terrorism is shared with the

appropriate intelligence and law-enforcement agencies. Conversely, USACIDC agents solicit and receive crime-related information from the MP and from local, national, and foreign law-enforcement and intelligence agencies. Special agents identify and evaluate crime-conducive conditions and indicators of potential attacks against Army property, facilities, or personnel. They then provide reports to the appropriate commander.

COMMAND AND CONTROL

9-3 The USACIDC is a centralized (stovepipe) MACOM whose special agents in the field report through the USACIDC's chain of command (detachment to battalion to group) to the CG, who in turn reports directly to the Army Chief of Staff and the Secretary of the Army (see Figure 9-1).

9-4 As an independent MACOM, the USACIDC's tactical units are not under the C² of supported organizations. The USACIDC's elements may be temporarily attached to a supported commander when required to accomplish a nonstandard mission. Reassignment, promotion, accreditation, and disciplinary actions are retained by the USACIDC. Attachments will be coordinated with the appropriate USACIDC headquarters, planning the specific mission and approved by the CG, USACIDC. Additionally, although there is no formal staff relationship, USACIDC commanders advise their supported commanders on criminal-investigation matters. This enhances the quality, reliability of information, support, and trust between USACIDC elements and their supported commanders.

WARTIME SUPPORT

9-5 The USACIDC supports each echelon of command from the division to the ASCC. The theater USACIDC structure is comprised of a C² headquarters.

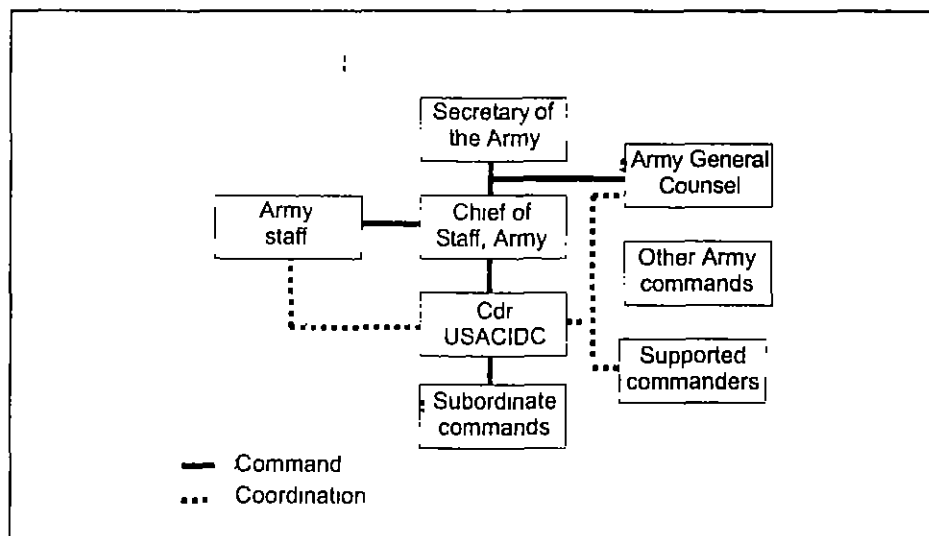

Figure 9-1 USACIDC Chain of Command

and mobile, modular, and tailorable investigative detachments. The USACIDC supports combatant commanders with the following functions:

- **LOGSEC.** Tracking and protecting materials and equipment from the manufacturer to the soldier on the battlefield
- **CRIMINTEL.** Collecting, consolidating, analyzing, and disseminating intelligence associated with criminal and terrorists activities targeted at Army interests
- **Criminal investigations.** Investigating war crimes and, in some cases, crimes against coalition forces and HN personnel
- **Protective-service operations.** As in peacetime, protecting key personnel anywhere on the battlefield

9-6 The USACIDC's LOGSEC function protects the Army's supply pipeline against criminal activities from the manufacturer, through logistics channels, all the way to the frontline soldier. It involves preventing, detecting, and investigating criminal and terrorist activities such as supply diversion, destruction, and sabotage or product substitution. The USACIDC's LOGSEC operations assess LOGSEC, identify weaknesses, and provide a prioritization of threats so that commanders can implement preventive measures to reduce the vulnerability of the logistics pipeline. Whenever possible, the USACIDC will initiate actions to recover logistical losses and return them to Army control.

The Army let a \$22 million contract for the manufacture of its mobile kitchen trailer (MKT)-90 mobile field kitchens in 1990. These kitchens were distributed to Army units worldwide, including those units serving in Saudi Arabia during Operation Desert Shield/Desert Storm. After distribution of the MKT was well underway, a US government quality-assurance representative received information from the manufacturer's employees indicating that the kitchens were not built to contract specifications. This information led to an investigation by the USACIDC's major fraud procurement unit (MFPU). The investigation revealed that inferior material and manufacturing processes were substituted, which allowed the contractor to realize an additional \$228,000 in profit. The US Army Environmental Hygiene Agency determined that the MKT-90 had serious sanitation defects and posed a safety hazard to troops using and being fed from these kitchens. The problem with the MKT was identified and expeditiously resolved to ensure the safety of soldiers in the field. The primary subject was indicted by a grand jury and subsequently pled guilty to one count of major fraud. He was found guilty, sentenced to 10 months confinement, and ordered to pay restitution.

9-7 The USACIDC's CRIMINTEL collection efforts focus on the identification and prevention of terrorist and nonterrorist crimes against US and allied military personnel, facilities, and other interests. Upon collecting this information, agents recommend countermeasures to combat subversive activities through coordination with MI, the PM, rear-area operations officers, and HN military and civil intelligence agencies. Additionally, when directed, the USACIDC becomes the lead US military investigative agency at theater.

level. When this happens, it is tasked with leading the prevention-of-terrorism effort from all services, not just the Army component

The MI analysts, the MP, and US Army criminal investigators deployed in Kosovo formed a combined all-source information center. This center provided threat assessments to units assigned to TF Falcon. Fifty-five percent of these assessments referenced some form of criminal activity. These intelligence products provided commanders with reliable information concerning potential incidents or criminal activity. With nearly 7,000 US soldiers deployed within the region, these assessments were absolutely crucial for the force-protection planning effort.

The fusion cell within the information center developed intelligence products from national, theater, and operational sources. Due to the significant threat posed by criminal elements in the region, two CID military agents and two CID civilian analysts were attached to the fusion cell to facilitate the police-intelligence function. The CID personnel, in cooperation with MP soldiers, played a key role by linking CRIMINTEL to specific groups and events. The CRIMINTEL collection effort was specifically targeted on weapons, drugs, organized crime, and the identification of smuggling routes. The identification of smuggling routes resulted in a significant increase in the number of weapons being confiscated. The timely transfer of CRIMINTEL products to tactical units enabled a rapid response to serious confrontations, increased confiscation of arms and ammunition, and improved stability in TF Falcon's AO.

9-8 During war and MOOTW, the criminal-investigation effort includes—

- War crimes and, when directed, crimes against coalition forces and HN personnel
- Major felony crimes committed by US personnel or EPWs/CIs and, when directed, crimes committed by foreign nationals in which there is an Army interest
- Criminal acts by indigenous personnel, factions, and ad hoc groups
- Special/sensitive investigations, hostage negotiations, polygraph operations, and force-protection operations
- CRIMINTEL operations

9-9 The USACIDC detachments provide enhanced coverage and protection for designated key and essential leaders during war and MOOTW. The protection requirement for senior JTFs and Army commanders may be significantly greater during MOOTW than during peacetime or war as the propensity of asymmetrical threats (such as criminal and terrorist groups) operating in the AO also increases.

ORGANIZATION

9-10 The USACIDC is organized with an array of multifunctional units. As with many other Army organizations, its force is in a transition process. During peacetime, the USACIDC groups provide brigade-level area support for worldwide Army operations. The group provides C², staff planning, and administrative support for USACIDC elements assigned to an AOR or

deployed to a contingency operation. During war, a group provides the same capabilities in support of an ASCC and provides C² for all USACIDC units in the theater. Regardless of the operational environment, the group ensures the connectivity between all USACIDC units. It establishes and maintains links with supported units and interagency, joint, multinational, allied, and HN authorities on matters pertaining to Army and USACIDC operations. The group headquarters has a command section, a detachment headquarters, an S1, an S2, an S3, an S4, an SJA, and a communications section. It provides C² for up to six subordinate battalions. Major differences in the AOE and Force XXI groups are in an increase of support and mission personnel and the movement of all polygraph support down to battalion level.

9-11 During peacetime, the USACIDC battalions provide area support for worldwide Army operations. They provide C², staff planning, forensic-science support, CRIMINTEL, polygraph support, technical guidance and supervision of USACIDC operations, and administrative support for USACIDC elements assigned to an AOR or deployed to a contingency operation. During war, the USACIDC battalion provides the same capabilities in support of each corps and TSC. Under AOE designs, one battalion supports each corps and TSC. Under the Force XXI design, up to two battalions support each TSC. Like the groups, each USACIDC battalion ensures connectivity and establishes and maintains links with other units/agencies within its AOR. The battalion headquarters consists of a command section, a detachment headquarters, an S1, an S2, an S3, an S4, and a communications section. It provides C² to five USACIDC detachments on a sustained basis. Its span of control can accommodate up to seven detachments for a short period of time. Major differences in the new battalion are the addition of a CSM, an S6 officer, a detachment commander and support personnel, and CRIMINTEL and forensic personnel.

9-12 The USACIDC investigative team is the smallest operational investigative element. Each team consists of two special agents (a warrant officer and a noncommissioned officer [NCO]). METT-TC requirements dictate that these teams have the capability to operate independently from the detachment headquarters. The investigative teams are the building block for both AOE and Force XXI USACIDC detachments. Both designs provide levels of flexibility to task-organize without splitting units apart. The detachment (with its complement of teams) performs the full range of criminal-investigative functions in all operational environments, but it has limited CRIMINTEL and LOGSEC management capabilities and no forensic or polygraph capability. Each detachment includes a headquarters section and up to eight investigative teams. METT-TC requirements dictate that these teams have the capability to operate independently from the detachment headquarters. The major differences between the AOE and Force XXI detachments' design begin with replacing the heavy and light division support elements (DSEs), the corps-area support element (CASE), the TSC-area support element (TASE), and the port-area support element (PASE) designs with a modular design consisting of a standardized headquarters element and two special-agent sections. Each section consists of four investigative teams. Personnel administration, supply, and the bulk of administrative support found in the AOE organizations have been consolidated at battalion

Additionally, the Force XXI detachment is commanded by a special-agent warrant officer

9-13 Both the AOE and the Force XXI units retain the Army's standard dependencies upon other units for support requirements (religious, health services, finance, photographic processing, and so forth) The new USACIDC TOEs have enhanced A/L support capabilities However, the new units still retain the AOE support requirement for food services and emergency Class III/V resupply from CS MP brigades, battalions, and companies

THE FIELD INVESTIGATIVE UNIT

9-14 Sensitive investigations are normally conducted by the field investigative unit (FIU) The FIU is a one-of-a-kind organization within the DOD that enables the Secretary of the Army to conduct sensitive investigations requiring access to special information or programs that are highly classified The FIU works closely with the Army IG, the Judge Advocate General of the Army, and the Army General Counsel to support commanders in the special-operations and intelligence communities and in the area of classified acquisition programs The FIU may also be assigned investigations involving senior Army personnel or those of special interest to the Army leadership

THE COMPUTER-CRIME INVESTIGATION UNIT

9-15 The computer-crime investigative unit (CCIU) deals with intrusions involving classified networks or multijurisdictional offenses The CCIU works closely with MI and federal law-enforcement agencies to coordinate military actions, nonmilitary-affiliated offenders, and foreign-intelligence services In addition, it provides technical assistance to CID elements that are conducting computer-related investigations

THE PROTECTIVE-SERVICE UNIT

9-16 The protective-service unit (PSU) provides worldwide protective services to designated personnel to protect them from assassination, kidnapping, injury or embarrassment The PSU plans, coordinates, and executes executive protection for—

- The Secretary of Defense
- The Deputy Secretary of Defense
- The Chairman of the Joint Chiefs of Staff
- The Vice Chairman of the Joint Chiefs of Staff
- The Secretary of the Army
- The Army Chief of Staff
- The Army Vice Chief of Staff
- Others (as directed)

9-17 During war and MOOTW, the USACIDC routinely provides protective-service support to senior Army ground commanders and, in some cases, to JTF commanders The USACIDC agents also provide training to the MP details providing protective services to senior field commanders

The President of the US hosted the North Atlantic Treaty Organization's (NATO's) 50th summit anniversary celebration in Washington, DC during the period of 22 to 26 April 1999. The President invited 28 heads of state or prime ministers, 48 foreign ministers, 88 ministers and chiefs of defense, and the chairman of the military committee to the summit. During the conference, the principal guests resided in 23 hotels in Washington, DC. The responsibility for providing protection for the ministers, chiefs of defense, and the chairman for the military committee was given to the USACIDC's PSU. In preparation for this mission, additional training on protective-service operations and evasive driving techniques was given to over 200 reserve agents. These individual mobilization augmentees, troop program units, and other USACIDC agents were critical to the successful execution of this mission.

US ARMY CRIMINAL-INVESTIGATIONS LABORATORY

9-18 Forensic-laboratory support is provided by the US Army Criminal-Investigations Laboratory (USACIL) that is currently located at Fort Gillem, Georgia. The USACIL is a nationally accredited forensic laboratory that provides all three services with dedicated, highly responsive, deployable, state-of-the-art scientific and forensic investigative support. The six forensic divisions of the USACIL include the following:

- Chemistry (serology, drugs, trace, and deoxyribonucleic-acid [DNA] testing)
- Questioned documents (alterations and comparisons of handwriting, typing, and printing)
- Firearms and tool marks (weapons and obliterated numbers)
- Photography (evidence charts and photos for court)
- Latent prints
- Computer forensics

9-19 The USACIL collects, receives, and examines evidence and prepares reports of findings. It also provides expert-witness testimony at court-martials.

US CRIME RECORDS CENTER

9-20 The US Crime Records Center (CRC) maintains the Army's criminal records. It maintains more than two million MP reports and USACIDC reports of investigations. These records are retained for at least 40 years before being destroyed. During their retention, the records are actively maintained and frequently researched.

During the course of an investigative search, civilian police authorities seized 19 hand grenades. A routine search of stolen property and criminal index files failed to identify the grenades as having been stolen from a nearby military installation. However, a search of the CRC files identified a USACIDC investigation relating to the theft of a case of grenades that occurred 20 years earlier. Further investigation revealed that the lot number of the recovered grenades was identical to that of the stolen grenades. The investigative leads resulting from the CRC file search contributed to the resolution of both cases.

9-21 The CRC conducts more than 10,000 criminal-history name checks each month to identify victims and perpetrators of criminal offenses. The checks are requested not only by USACIDC agents, but also by other military and civilian law-enforcement officials. The CRC is also the Army's agent for Freedom of Information Act (FOIA) and Privacy Act requests relating to criminal investigations and MP reports. The CRC also manages the Army's polygraph programs and their support to Army installations around the world.

EMPLOYMENT

9-22 Whenever possible, USACIDC units are colocated with the MP. This provides unified MP support across the battlefield, and it facilitates logistical support (primarily mess) provided by MP units. However, the USACIDC maintains its vertical C². Based on METT-TC, the MP group (CID) will collocate with the supported ASCC and the MP battalions (CID) supporting the corps and EAC will collocate with the MP brigade (CS). When feasible, MP detachments (CID) will collocate with MP battalions/companies and division MP companies. Figure 9-2 illustrates a typical battlefield array for AOE organizations, and Figure 9-3 illustrates a Force XXI array.

9-23 Since USACIDC detachments are austere organizations with little organic A/L capability, they rely on the battalion for unit-level maintenance, supply, and personnel support. However, detachments must often operate independently when performing criminal-investigation functions throughout the AOR. During these times of long-distance separation, detachments must seek A/L support from the supported unit.

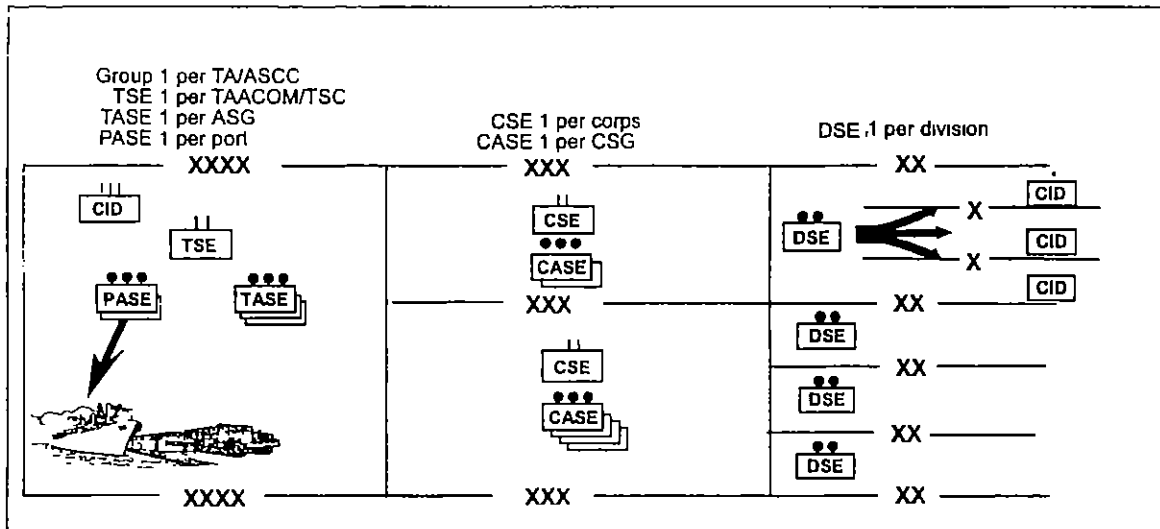

Figure 9-2 AOE Battlefield Array

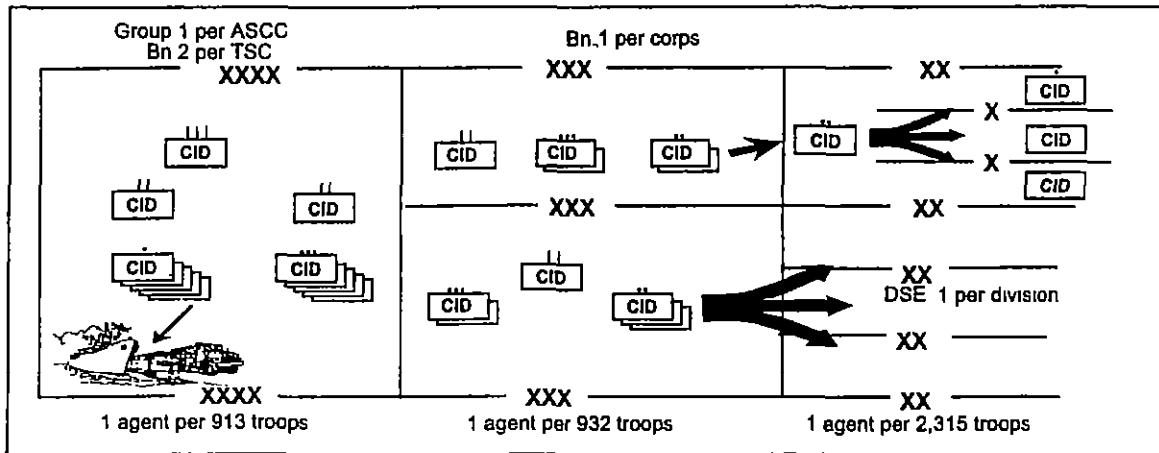

Figure 9-3. Force XXI Battlefield Array

Chapter 10

Offensive and Defensive Operations

The whole of military activity must relate directly or indirectly to the engagement. The end for which a soldier is recruited, clothed, armed, and trained, the whole object of his sleeping, eating, drinking, and marching is simply that he should fight at the right place and the right time.

Clausewitz

Army doctrine considers the full range of operations from war to MOOTW. An operation is a military action or the carrying out of a military mission needed to gain the objectives of any battle or campaign. Offensive and defensive operations normally dominate military operations in war and in some smaller-scale contingencies. An offensive operation is aimed at destroying or defeating the enemy and imposing our will on him for a decisive victory. Defensive operations defeat an enemy attack, buy time, economize forces, or develop conditions favorable for a counteroffensive that regains the initiative and defeats the enemy.

OVERVIEW

10-1 The offense is the decisive form of battle. Offensive campaigns and major operations are designed to achieve operational and strategic objectives quickly and decisively at the least cost. Offensive operations combine the terrain and the force to achieve the objective. The main purpose of the offense is to defeat, destroy, or neutralize the enemy force. Offensive operations are characterized by a rapid shift in the main effort to take advantage of opportunities by momentum and simultaneous destruction of enemy defenses.

10-2 The immediate purpose of defensive operations is to defeat an attack. Military forces defend only until they can gain sufficient strength to attack. Commanders choose to defend when they need to buy time, to hold a piece of terrain, to facilitate other operations, or to erode enemy resources at a rapid rate while reinforcing friendly operations. The ARFOR conduct defensive operations as part of major operations and campaigns and in combination with offensive operations (see FM 3-0).

SUPPORT TO OFFENSIVE OPERATIONS

10-3 MP support to offensive operations varies according to the type of operation being conducted. The MP functions support each echelon commander based on METT-TC. In the offense, MP priorities are often placed on MMS, I/R, and AS operations. Regardless of the offensive effort, MP leaders supporting an offensive operation must—

- Understand the commander's intent and his concept of operations
- Anticipate that selective elements of the offensive force may need to pause, defend, resupply, or reconstitute while other forces attack
- Anticipate changes in the operational tempo and prepare to weight the MP effort to meet the maneuver commander's intent
- Provide MP support within the context of linear and nonlinear operations. They must understand how both types of operations affect the security of rear areas and LOC, the protection of C4I, the means of sustainment, and the land force's mobility
- Support the maneuver commander's intelligence efforts by conducting the PIO function. The MP must observe, identify, and report information
- Assist maneuver forces to mass. The MP protect C² nodes such as the CP that orchestrates the mass efforts and resources that sustain the offensive move. The MP must deny incursions by enemy reconnaissance forces into the AO. They also maintain surveillance, provide early warning, and impede and harass the enemy with supporting and organic fires
- Speed the commitment of follow-on forces and reserves. They must also conduct MMS operations to assist the commander in a smooth and quick shift of forces to support the main effort
- Anticipate the pursuit and exploitation by positioning MP forces that can support continuous operations. The MP support as far forward as possible while protecting resources needed to seize the opportunity. The EPWs/CIs are collected as far forward as possible. The MP coordinate the treatment of dislocated civilians and refugees with the HN or foreign forces
- Tailor the MP support based on the unit being supported (corps, divisions, and brigades)
- Consider the location and composition of response forces and the TCF and the strength of rear-area threats
- Integrate a force into the offensive plan that is capable of conducting aggressive combat operations against designated targets

During Operation Just Cause, an MP platoon received the mission to disable an armed Panamanian Defense Force (PDF) patrol boat docked near a key objective. After receiving the mission, the platoon leader maneuvered his force into position and attacked after receiving enemy fire. The platoon successfully disabled the patrol boat and captured the objective while suffering minimum casualties.

10-4 During offensive operations, MP support provided by teams, squads, and platoons provide the commander with an agile, flexible, versatile, and capable force ready to contribute to the overall mission success.

SUPPORT TO DEFENSIVE OPERATIONS

10-5 The MP support defensive operations consistent with the commander's intent and priorities. They support a defending force by assisting subordinate elements in the execution of different, yet complementary actions. For example, the MP may support the maneuver of an attacking unit by conducting MMS operations while simultaneously providing AS for a defending unit in a base cluster. The MP support reflects the maneuver commander's focus—destroying an attacking force, retaining or denying key terrain, moving away from an enemy force, or a combination of the aforementioned. However, despite the intent of the defensive operation being conducted, MP leaders must—

- Conduct MMS operations to help a force maneuver and mass. The MP must anticipate the shift from the defense to the offense and assist the forward movement of reserves.
- Conduct AS operations to deny information to enemy reconnaissance elements seeking out the exact location of the defending force. The MP are positioned where they can control key terrain or improve the defensive capability of bases and base clusters. The MP conduct aggressive R&S to locate and deny enemy access to critical logistical facilities.
- Protect sustainment resources while supporting the lateral, forward, and rearward movement of forces.
- Consider the type and size of the AO, the LOC security, the rear threat, and the number of EPWs/CIs and dislocated civilians to determine how they may affect the movement of forces.

During Operation Desert Shield, EAC, corps, and division MP units conducted a myriad of missions to support both the XVIII Corps's (Airborne) and the VII Corps's movement to their TAA. The MP's main focus was on MMS and AS throughout the AO to ensure freedom of movement and to protect US and coalition forces against terrorists and other threats in the rear area.

10-6 The success of MP operations in the defense depends on the MP leader's situational awareness, the commander's intent, and the precise employment of MP resources when and where they are needed. In the defense, the MP perform their five functions to assist the defending commander by providing a lethal mobile force that allows him to concentrate his efforts and resources in fighting the next battle.

Chapter 11

Stability and Support Operations

ARFOR conduct stability operations in a complex, dynamic, and often asymmetric environment. Stability operations are usually nonlinear and noncontiguous. They are often time and manpower intensive. The purpose of support operations is to meet the immediate needs of designated groups for a limited time until civil authorities can accomplish these tasks without Army assistance.

FM 3-0

The Army's mission is to prepare for war and, when deterrence fails, to achieve a quick, decisive victory. The DOD projects that many of its future missions will be stability and support operations. However, these operations are not new to the Army. The Army has participated in stability and support operations in support of national interests throughout history. The Army has protected its citizens, assisted nations abroad, and served America in a variety of other missions. The pace, frequency, and variety of stability and support operations have quickened in the last three decades. As demonstrated in Operations Provide Comfort, Restore Democracy, and JTF Los Angeles, these types of operations present a challenge to all services.

OVERVIEW

11-1 Stability operations are conducted outside of the US and its territories to promote and protect US national interests by influencing political, civil, and military environments and by disrupting specific illegal activities. Stability operations may include both developmental and coercive actions. Developmental actions enhance a HN government's willingness and ability to care for its people. Coercive actions apply carefully prescribed limited force or the threat of forces to change the AO's environment.

11-2 Support operations provide essential supplies and services to relieve suffering and to help civil authorities prepare or respond to crises. In most cases, the ARFOR's efforts are focused on overcoming conditions created by man-made or natural disasters. The ultimate goal of support operations is to meet the immediate needs of designated groups (for a limited time) until civil authorities can accomplish these tasks without Army assistance.

11-3 Stability and support operations are distinctly different from offensive and defensive operations and must be analyzed differently. For instance, the application of the rules of engagement (ROE) will be unique to the operation. The restrictions on combat operations and the use of force must be understood and obeyed at all levels. MP leaders must clearly take the initiative and

ensure that the applicable guidance is implemented and followed by all subordinates

11-4 Stability and support operations have more diverse political considerations than are usually encountered in war. There are also complexities that must be addressed in joint, combined, and interagency stability and support operations. The Army's challenge is to execute these operations successfully in a joint or combined arena without degrading its capability to wage war successfully.

11-5 If the US is to fight and win future wars, it must develop, train, and employ its force structure in a manner that ensures success in every operation across the spectrum of military operations. Under these auspices, MP forces can provide commanders with especially valuable assets for stability and support operations. The MP have the unique capability of serving as a combat, CS, and CSS force. The domestic and international acceptability of the MP operational image frequently makes the MP the most appropriate force for stability and support operations. Additionally, the MP are flexible and capable of rapidly transitioning from one end of the spectrum to the other if the environment changes.

FORCE SUITABILITY

11-6 The MP's capabilities and their operational and supporting tasks are as integral to stability and support operations as they are to offensive and defensive operations. MP branch-/core-related skills are highly compatible with the capabilities required for stability and support operations. The MP provide a highly capable, politically acceptable force that is suitable for a variety of missions. They possess robust moving, shooting, and communicating capabilities, and they project an assist, protect, and defend image that is particularly important when tailoring a force that requires significant capabilities but a low political profile. The MP provide a flexible, but limited, economy-of-force organization. Mission requirements will always exceed available MP resources, especially in stability and support operations. For this reason, MP assets must be prioritized to deliver the greatest mission capability. The specific operations that MP units perform at a given time are determined by the echelon commander's needs, the mission requirements, and the availability of MP resources. As discussed in previous chapters, the echelon commander, through the command's PM, sets the priorities for MP operations. As in offensive and defensive operations, the PM knows that while the MP force can perform all MP functions, they may not be robust enough to perform all assigned MP missions all of the time. The PM must continuously make trade-offs between the numbers and kinds of MP missions that can be supported.

11-7 The MP's capabilities are further enhanced by their training, mind-set, and experience in dealing with people in highly stressful and confusing situations. Although capable of conducting combat operations when needed, the MP are highly practiced in de-escalation and in employing the minimum-essential force to contain potentially violent situations. This mind-set serves as the framework for MP law-enforcement training and is especially applicable in MP support for stability and support operations. Furthermore,

this mind-set is exercised and reinforced daily in peacetime law-enforcement operations. This is a significant capability. MP soldiers learn and receive constant reinforcement training in controlling a situation on the spot before it escalates and cannot be controlled. The MP have a unique understanding of human nature and are adept at handling emotion-laden situations.

During operations in Kosovo, as both Serbs and Albanians attempted to create unfavorable conditions and responses by US forces, the MP kept their cool under fire in the streets of Gnjilane and Kamenica. The MP's reaction led to a quick understanding by all sides that the US Army MP were fair and just and understood the tense situations.

11-8 The MP stress four essential training competencies—skill proficiency, human dimension and attitude, camaraderie and teamwork, and leadership. These competencies are the foundation for all MP operational performances. They equip the MP to exercise discretion in dealing with others, to protect and assist those in need, and to accomplish the varying demands of MP missions in stability and support operations and, when needed, in war.

STABILITY AND SUPPORT

11-9 Stability and support operations are performed in support of US authorities or in support of international bodies and foreign governments when so required by US authorities. The MP have long provided the essential support for stability and support operations, however, the frequency of these operations has increased significantly in recent years. Consequently, the MP have been deployed in greater numbers with greater frequency. MP units have a substantial history of successful, simultaneous, and continuous deployments in both a lead and a support role.

SUPPORT TO DOMESTIC CIVIL AUTHORITY

11-10 The purpose of support to domestic civil authorities is to—

- Render humanitarian assistance
- Provide disaster relief
- Restore order
- Combat terrorism
- Support counterdrug operations

11-11 Military operations supporting domestic civil authorities are governed by the provisions of the Stafford Act, the Posse Comitatus Act, and other laws and regulations. Peacetime experience in civil-military affairs equips the MP to oversee, assist, and train other units and agencies for law enforcement, sensitive security, and operations to control dislocated civilians (within the legal limits of a particular stability or support operation). For this reason, the MP are often needed after other forces have redeployed, and they stay until government order is restored. Since active-component military missions are constrained by the Posse Comitatus Act, nonfederalized national guard (NG) units are often employed to conduct these operations (particularly

counterdrug operations) The NG units can operate under gubernatorial authority within state jurisdiction without Posse Comitatus restrictions The NG MP units are the only NG units trained, skilled, and experienced in providing law enforcement They offer civilian authorities a unique, specialized capability not available from other NG units

SUPPORT TO HUMANITARIAN ASSISTANCE AND DISASTER RELIEF

11-12 Humanitarian assistance and disaster-relief operations provide emergency assistance to victims of natural and man-made disasters and other endemic conditions Natural disasters include earthquakes, floods, and hurricanes Man-made disasters include riots and civil conflicts Humanitarian assistance and disaster relief conducted by US forces alleviate urgent nonmilitary needs of a populace until the appropriate civilian agencies can provide the needed services without military support These types of operations include, but are not limited to—

- Conducting searches and rescues.
- Evacuating, sheltering, sustaining, and protecting dislocated civilians
- Making food, medical care and treatment, and other civilian-aid programs available
- Reducing opportunities for criminal activity and restoring L&O
- Maintaining other operations needed to ensure the well being of the affected population
- Providing relief operations for man-made disasters These operations are characterized by civil conflict, and they entail all of the requirements for other disasters but focus on the restoration of L&O
- Providing force protection and security

11-13 MP support can be an important asset in all disaster-relief operations The MP are trained and equipped for decentralized operations MP teams operate in highly mobile vehicles equipped with radios, which are invaluable in disaster-relief operations Each MP platoon, company, and battalion headquarters is equipped with high-frequency radios These capabilities allow the MP (even when widely dispersed) to maintain centralized communications, to provide L&O support, and to assist in search, rescue, and evacuation efforts Because of their decentralized operations and communications equipment, the MP can also play a vital role in notification, ADC, and access and egress control They can deploy with disaster-assessment teams to assist in advising and developing a disaster-assistance plan The MP can also deploy to an affected area to—

- Assist in restoring order
- Search for, rescue, and evacuate victims
- Provide personnel and vehicular circulation controls
- Provide ADC
- Conduct detention operations
- Provide physical and area security to protect life and property immediately following a disaster
- Protect fire and emergency-services personnel
- Gather, record, and report information
- Provide force protection and security

11-14. MP (I/R) battalions can support civil-affairs units by establishing I/R facilities to shelter, sustain, protect, and account for disaster-relief victims. These units can also train and assist government agencies (US and foreign) or police in the operation of facilities for dislocated civilians and detainees.

11-15. The MP possess capabilities critical to relief in man-made disasters characterized by civil conflict. The MP have the essential training and skills needed for relief operations that focus on restoring civil order. Restoration of civil order demands—

- **Objectivity and neutrality.** The objective of civil-disturbance control is to restore L&O, not to impose punishment or suppress peaceful dissent. Government forces quelling civil disorders must be emotionally objective and politically neutral. MP law-enforcement training stresses objectivity and neutrality, an important attribute for forces employed in stability or support operations.
- **Minimal use of force.** The application of more than minimum force may be detrimental to mission success. The MP are particularly suited for these situations, having been trained on the technique for the use and measured application of minimum forces to accomplish mission goals.
- **Public acceptance.** Government forces must avoid actions that will alienate the populace. Any action offensive to community sensitivities must be avoided. The MP receive training in crowd-control operations, interpersonal communications skills, and minimum use-of-force techniques—skills that are critical in gaining public acceptance.
- **Positive image.** In many disturbance operations, demonstrators and government forces compete for the approval and sympathy of the general population. The MP's assist-and-protect image provides the government with a distinct advantage in such situations.
- **Threat awareness.** Government forces must pay attention to and try to learn the organization, intentions, and activities of demonstrators. Equal attention must be paid to how the community will respond to the demonstrator's actions and the government's response. The MP interact daily with the populace, placing them in a position to develop criminal information and to determine the collective attitude of the populace.
- **Effective coordination.** Disturbance operations often involve many agencies from various levels of government. Thorough, timely, and coordinated preparation, planning, training, and execution are essential for mission success. MP civil-disturbance training (including planning and coordination measures) and their communications assets enhance coordination, particularly during mission execution.
- **Operational unity.** Multiple control forces representing different agencies with varying jurisdictional authority can pose C² problems. When unity of command cannot be achieved, operational unity must be achieved by collocating operational centers, integrating communications, and delineating organizational responsibilities. The MP are well trained in police and military operations, possessing a sound understanding of both civilian police and military measures, legal constraints, and effective coordination.

11-16 The MP operational tasks supporting man-made disasters vary according to the nature of the disaster and the operational environment. For example, in CONUS where the commitment of military forces to civil disturbances is considered a last resort and military involvement is limited by law, nonfederalized NG MP units have long been employed by civil authorities for their unique capabilities. MP forces can—

- Isolate and contain an area with barricades, roadblocks, and perimeter patrols. The MP can also assist civil-affairs units by enforcing pass and identification systems and public-utility controls.
- Provide mobile patrols to enhance the security of high-priority targets (such as buildings, utilities, and services that are critical to the community's economic and physical well being).
- Monitor, disperse, contain, or limit crowd movement through—
 - Observation points and patrols
 - The communication of interest and intent to the crowd
 - The channelization or diversion of the crowd
 - Gaining the cooperation of the dissident leadership
 - The proclamation of the illegal nature of the crowd's actions
 - Show of force
 - The use of crowd-control formations
 - The apprehension of crowd members and leaders
 - The application of minimum-force measures
- Establish area control to prevent looting, to protect businesses and other likely targets, and to prevent arson. The MP accomplish this mission with saturation patrolling, including vehicle and foot patrols. With augmentation, the MP can perform air and water patrols. They also enforce populace control measures (such as ordinances to prevent gathering, permits to gather, restrictions on circulation, restrictions on the interference with government and public functions and personnel, restrictions on possessing weapons, and other measures instituted by civil authorities).
- Neutralize special threats (such as snipers and bombings) that are highly dangerous to both government forces and the community. Snipers pose a particularly grave danger in disaster-relief operations. The MP can take immediate protective actions, secure an area, isolate the threat and when authorized, use SRTs to assist civilian or HN authorities in apprehending or neutralizing the sniper. The MP are trained to perform the necessary actions when an explosive device is discovered. In such an event they can secure and evacuate an area, organize search teams, and isolate the site.

11-17 The MP can also support in rescue and recovery operations, which may include rescuing US or foreign nationals. Such operations are also employed to locate, identify, and recover sensitive materials deemed critical to national security. The operations may be conducted in benign or hostile environments. The MP provide OPSEC, and they process and account for civilians affected by rescue and recovery operations. The MWD teams can also help search for lost or hidden personnel. In stability and support operations, the MP can perform

their police functions for rescue and recovery operations while keeping the perceived military signature low

SUPPORT TO COUNTERDRUG OPERATIONS

11-18 Counterdrug operations are measures taken to disrupt, interdict, and destroy illicit drug activities. In a counterdrug role, the DOD may offer certain forms of support to HN counterdrug personnel, to US civilian law-enforcement agencies operating in a HN, to Department of State (DOS) counterdrug personnel, and to the Bureau of International Narcotics Matters. Without direction from the National Command Authority acting under constitutional or statutory authority, US forces engaged in counterdrug activities may not engage in direct law-enforcement activities (such as apprehension, search, seizure, and other similar activities). As discussed earlier, the Posse Comitatus Act authorizes specific DOD assistance in counterdrug activities, but US military forces usually may not participate directly in arrests, searches, seizures, and similar activities. Conversely, as discussed earlier, USC Title 32 authorizes state governors to use NG MP units with full authority to engage directly in law-enforcement activities. When authorized, US advisors may accompany counterdrug forces on operations.

11-19 MP operational contributions can include the use of force, drug identification, crime-scene protection, customs operations, surveillance of criminal activity, serious-incident reporting, and other related activities. Employing the MP for these operations ensures force suitability and avoids a mismatch in terms of unit capability and mission effectiveness.

11-20 Border-screening operations consist of three separate but related measures—mobile patrolling, the use of listening/observation posts, and airfield surveillance. These measures are part of the MP's AS and MMS functions used in tactical rear-area operations. The MP's operational effectiveness may be further increased through augmentation by a civilian law-enforcement officer who would be responsible for search, seizure, and arrest actions. Active-component units are permitted to assist in marijuana eradication in support of domestic law-enforcement agencies (DLEAs). Marijuana-eradication operations are an application of the MP AS, mobility, and L&O functions, thus providing realistic training while supporting an operation.

11-21 As discussed in previous chapters, the MP are well suited to augment customs operations. They routinely perform customs inspections for US forces in Korea and Germany. The NG MP regularly conduct vehicle, cargo, and container searches under the supervision of US Customs agents and at US ports of entry.

11-22 The USACIDC agents can provide support to counterdrug operations. The CID units identify the sources of illegal-drug distribution systems. When directed, the MP and the CID complement interagency counterdrug efforts to stop the production, flow, and distribution of drugs and to provide planning, training, equipment, and facilities to support domestic counterdrug operations. The CID also supports CRIMINTEL programs, internal security, and site surveys at borders where Army units will deploy. In addition to the

aforementioned support, the DOD General Counsel has ruled that MWD teams can be loaned to DLEAs to assist in detecting smuggled contraband

SUPPORT IN COMBATING TERRORISM

11-23 The Department of Justice (DOJ) is the lead federal agency for dealing with acts of terrorism within the US, its territories, and its possessions. Within the DOJ, the Federal Bureau of Investigation (FBI) has the lead. The FBI can train the police of friendly nations in antiterrorism and counterterrorism operations. Usually, US military forces act in a technical-advisory but not a law-enforcement capacity in combating acts of terrorism. It is often difficult to distinguish the acts of politically motivated terrorists from violent acts of criminals or individuals in society at large. In fact, all terrorist acts are criminal, however, they also may be part of an insurgency.

11-24 The MP are key players in the defensive planning, implementation, and control of combating-terrorism operations, whether in garrison or deployed to war or MOOTW. In whatever countries US forces operate, MP units conduct antiterrorism operations daily as part of their L&O and AS functions. The MP also respond to terrorist incidents. They help secure the area and search for evidence, and they help the lead agency. The MP provide advice and assistance in developing antiterrorism and counterterrorism programs for deployed US forces and DOS agencies and for police, paramilitary, and military forces of assisted nations (when so authorized). MP training, liaison, and joint patrols help strengthen HN-police organizations, improving their effectiveness and efficiency in combating terrorism. The MP also assist HN police in performing PRC operations.

11-25 The training of police (domestic and foreign) requires DA approval, and restrictions exist on some forms of training. Legal advice and coordination are a must before training can occur. The MP and the CID provide personnel and equipment for planning, advising, equipping, and training agencies to prevent, deter, and respond to terrorism. The training focuses on deterring terrorist acts such as bombings, kidnappings, assassinations, taking hostages, and hijackings. Related assistance may include training and equipment for explosive detection, management of hostage situations, physical security, protection of key personnel, and defensive/evasive driving methods. For counterterrorism operations on US military installations, the MP provide highly trained, specially equipped SRTs for situations requiring the selective use of force. Additionally, CID agents are highly trained in hostage negotiation, which increases the commander's options before resorting to force.

11-26 The MP and the CID assist in counterterrorism information-gathering activities through liaison and joint patrols with HN police. These activities are part of the PIO function. The MP have extensive contacts with civilian police, who in turn have contacts with the populace. These contacts can help surface criminal information concerning terrorist plans, recruitment, and support structures sooner than military sources. The CID can provide commanders with CRIMINTEL on a daily basis. At the same time, MP antiterrorism support includes measures to reduce the vulnerability of people and property. Such measures include—

- Personal awareness
- Personal-protection operations and techniques
- Crime prevention
- Physical-security programs

11-27 The MP and CID crime-prevention programs employ proactive measures to protect people and their property and US and HN property. Crime prevention is a continuous process of planning, implementing measures, evaluating effectiveness, modifying measures, and developing further information. The primary crime-prevention tool is the crime-prevention survey. It is used to examine the physical features of various critical sites. The MP physical-security programs help identify, reduce, eliminate, or neutralize conditions favorable to criminal, terrorist, and insurgent activities. The key measures used to accomplish this are physical-security inspections and surveys.

SUPPORT TO NONCOMBATANT EVACUATION OPERATIONS

11-28 Noncombatant evacuation operations (NEOs) relocate civilians who are endangered in a foreign nation. The NEOs are classified as benign (unopposed) or hostile (opposed). MP roles in support to NEOs differ accordingly. In a benign environment, NEOs are usually conducted with the help and full cooperation of the affected nation, with little or no opposition to evacuation. The use of force is limited to self-defense (as outlined by the ROE) and protection of the evacuees. In a hostile environment, NEOs are opposed by forces with specific intentions of preventing or destroying the operation. In this scenario, the MP will follow the ROE as established by higher headquarters.

11-29 MP operations in NEOs closely parallel EPW/CI evacuation operations. The objective of both is to safely collect, secure, protect, transport, process, and account for people, whether they are EPWs or noncombatants. However, due to the dissimilarities of these groups, the techniques employed differ.

11-30 The MP can secure selected facilities, reception and transfer points, or other locations required to collect, process, and evacuate people. They can provide route reconnaissance and mobile security teams to escort HRP, DOS personnel, evacuees, and sensitive material. If needed, MP units assist civil-affairs personnel with the movement and control of dislocated civilians. The MP may support civil affairs by setting up and operating evacuation sites, holding areas for foreign nationals denied evacuation, and reception and processing stations. This support can be provided by MP CS units for a short duration and by MP I/R units for a prolonged duration. Additionally, the MP will establish and maintain liaison with HN police to ensure a mutual understanding of jurisdiction, to coordinate efforts, and to provide criminal and tactical intelligence. In hostile environments requiring the employment of combat forces, the MP would be employed in their traditional CS role.

SUPPORT TO SECURITY-ASSISTANCE OPERATIONS

11-31 Security-assistance operations are one of the main tools of US foreign policy. A critical concern in these operations is the HN's ability to plan and

manage its own defense resources. In security-assistance operations, the US provides defense materiel, military training, and defense-related services through grants, loans, credit, or cash sales. When authorized, the MP support security assistance with military and police training through the International Military Education and Training Program (IMETP). This program provides instruction and training to foreign military and civilian personnel on a grant/aid basis. Many foreign civil law-enforcement agencies request training in the following areas:

- Basic police procedures (such as patrolling and crime-scene protection)
- Physical security
- Corrections
- Civil-disturbance operations
- Customs operations
- Traffic control
- Use of force

11-32 The MP possess the expertise and experience to advise, train, and assist a HN's military and police forces. The MP's participation in the IMETP includes—

- Formal and informal instruction of foreign students
- Technical education and tactical training with applicable training aids
- Assistance to foreign police and military elements by MP mobile training teams (MTTs)
- Providing MP units or small, modular, functionally specific teams to support security-assistance needs. These teams can train HN police in both field and institutional facilities
- Support to nation-assistance operations

11-33 Nation-assistance operations support a nation's effort to promote development, ideally by using its national resources. This is achieved through education and the transfer of essential skills to the HN. The goals of such operations are to—

- Promote long-term regional stability
- Develop sound and responsive democratic institutions
- Develop supportive infrastructures
- Promote an environment that allows for orderly political change and economic progress

11-34 The MP support nation-assistance operations with training and joint MP and HN-police operations. The MP know and understand police operations, military operations, and C² procedures. Consequently, the MP are ideal for training the law-enforcement personnel in both field and institutional settings. The MP's nation-assistance goals are to—

- Enhance L&O in democratic societies
- Improve efficiency and effectiveness
- Promote the proper usage and maintenance of equipment
- Establish a sound training base for police

- Standardize procedures that enhance combined police operations
- Promote friendship and goodwill toward the US
- Preclude the need for US military interventions to counter acts of violence

11-35 Combined police operations reinforce training and provide HN police with mobility, security, and communications to operate more effectively while conserving critical personnel resources. The MP provide support through training and the following:

- Law-enforcement, security, and criminal-information support to the HN police force (to include L&O operations and administration in a democratic society)
- Patrol and desk operations
- Circulation-control operations
- PRC and civil-disturbance operations
- MWDs
- Physical-security operations
- Personnel-security operations
- Area- and route-security operations
- Counterdrug operations
- Antiterrorism operations
- Mass immigration operations
- Customs and border operations
- Confinement operations
- Crime prevention
- Community and police relations
- C² of police operations

11-36 When conducting nation-assistance operations, as well as other operations, the MP will often be tasked to support civil-affairs operations. Close coordination with the G5/S5 and liaison with the appropriate HN representatives have added emphasis to these types of operations. The scope of civil-affairs operations is influenced by the economic, social, psychological, and political background of the country and its people. Civil-affairs personnel will coordinate the MP's effort to restore stability, contribute to national development, and promote support for the host government. Civil-affairs personnel assist in preventing civilian interference with military operations and coordinate all other military and civil affairs (such as community relations, PRC, civil defense, and community- and area-security programs).

11-37 The MP can conduct ADC measures to assist the HN in the aftermath of a natural or man-made disaster. They help rescue and evacuate the injured for medical care, and they issue food, water, and essential supplies (See FM 41-10).

SUPPORT TO PEACEKEEPING OPERATIONS

11-38 Peacekeeping operations (PKOs) are military operations conducted with the consent of the belligerents in a conflict. The PKOs are intended to maintain negotiated truces and to facilitate diplomatic solutions. The US may

participate in a PKO under the auspices of an international organization, in cooperation with other countries, or unilaterally. A PKO usually occurs in an ambiguous situation in which there is extreme tension and the possibility of violence. This violence may range from terrorism and sabotage to minor military conflicts involving known and unknown belligerents. MP forces may serve as an element of a UN peacekeeping force or as part of a multinational observer group. The overall operational control of a peacekeeping force is exercised by a multinational staffed military peacekeeping command. However, the commander of each assigned national force retains command integrity of his unit.

11-39 The basic MP force structure and appropriate augmentation are situation dependent. The size and composition of the MP forces are determined by diplomatic negotiations. Personnel spaces are allocated based on the US contingents' respective missions. The principle of consent affects the composition and function of the peacekeeping force. Consent applies to the degree of interest the disputing countries have when contributing their forces to participate in the peacekeeping effort.

11-40 Each PKO is unique but is generally characterized by constraints in the use of force. In a PKO, force is normally limited to self-defense, the defense of others, and the protection of national security. Therefore, the soldiers in a PKO must possess the skills required for warfare, but they must also be trained so that they are equally able to act as intermediaries. In this aspect, the MP are a distinct asset. They are experienced in a case-by-case approach to the use of force. They are experienced in using discretion and in the de-escalation of potential violence. The MP training in EPW operations are especially useful in handling EPWs if the peacekeeping force supervises the exchange of prisoners of war.

11-41 The peacekeeping force employs a combination of the following techniques to control the potential for violence inherent to PKOs:

- Observation is the peacekeeping force's primary responsibility and basic requirement. It provides timely and accurate reports of any suspicious situation, incident, or occurrence.
- Information gathering is a continuous requirement. Peacekeepers must be constantly alert to what takes place around them and to any changes or inconsistencies in the behavior, attitude, and activities of military and civilian personnel.
- Surveillance and supervision operations help oversee the implementation of agreements. The operations require restraint, tact, and patience.
- Complaint investigations must be thorough and objective, and they must result in a fair assessment.
- Negotiation and mediation skills are often required of peacekeepers. If peacekeepers can resolve minor problems at the lowest level, they can prevent major issues from rising, which may prevent increased tensions or the resumption of fighting.
- Patrolling (mounted and dismounted) among the population publicizes presence. It also serves as a means of gathering information, informally enhancing supervision, and investigating complaints.

11-42 The above techniques are compatible with MP battlefield functions. Operationally, the MP conduct route and area R&S, operate mounted or dismounted patrols, operate listening/observation posts, provide humanitarian assistance, investigate possible terrorist and criminal acts and cease-fire and sanction violations, and gather information. The MP provide a flexible, wide-ranging means of information dissemination. Additionally, they provide crucial support for force protection. The MP and the CID employ active and passive measures to deter and defeat threats directed at service members, their families, DOD civilians, facilities, equipment, and very important persons (VIPs). The MP use emerging technologies in force protection to conduct security, detection, and identification operations and to warn of intruders.

11-43 As part of a PKO, the MP conduct crowd- and riot-control operations, including the extraction of mob leaders. The MP are an ideal force for controlling antagonistic masses engaged in rioting, looting, and demonstrating. The MP understand how to make the transition from the lower end of the use-of-force spectrum to the use of lethal force, if so required or directed. Finally, the MP deploying with peacekeeping forces can provide early-on force protection, including headquarters and initial aerial port/seaport of debarkation (APOD/SPOD) security. The MP's mobility, firepower, and communications provide critical reconnaissance, information-collection, and response-force capabilities and acceptability not found in combat forces.

11-44 When conducting crowd- and riot-control operations in a PKO or peace-enforcement operation (PEO) nonlethal weapons (NLWs) are an additional means of employing force for the purpose of limiting the probability of death or serious injury to noncombatants or belligerents. However, the use of lethal force must always remain an inherent right of individuals in instances when they, their fellow soldiers, or personnel in their charge are threatened with death or serious bodily harm. The NLWs add flexibility to the control of disturbances by providing an environment where military forces can permissively engage threatening targets with limited risk of noncombatant casualties and collateral damage (see FM 90-40).

11-45 The use of lethal force (employed under the standing ROE) will never be denied. At no time will forces be deployed without the ability to defend themselves against a lethal threat nor will they forego normal training, arming, and equipping for combat. Nonlethal options are a complement to, not a replacement for lethal force. They seek to expand a proactive response across the range of military operations.

11-46 The decision to use NLWs against an adversary during a confrontation should be delegated to the lowest possible level, preferably to the platoon or squad. However, this requires that all personnel (not just leaders) have a clear understanding of the ROE and the commander's intent.

11-47 Commanders and public-affairs officers must be prepared to address media questions and concerns regarding the use and role of NLWs. They must be prepared to address the role of NLWs, and they must make it clear that the presence of NLWs in no way indicates abandoning the option to employ deadly force in appropriate circumstances.

11-48 The PEOs are in the high end of the PKO's spectrum. These operations are just short of combat and require a different operational approach. MP operations to support PEOs correspond to MP battlefield functions supporting combat forces. The PEOs often pose special operational considerations for dealing with dislocated civilians. The MP provide PRC operations and I/R, when required.

ORGANIZATIONS AND CAPABILITIES

11-49 MP units are well suited for stability and support operations given their unique capabilities and low force signature. The MP brigade, battalion, company, and I/R units may be tailored for stability and support operations based on their unique METT-TC.

MP BRIGADE TF

11-50 In essence, the organization and capabilities of the MP organization in stability and support operations is the same as those for other operations. However, its augmentation is tailored based on METT-TC unique to stability and support operations and the commander's needs. The MP brigade has been the centerpiece of successful MP deployment during previous stability and support operations. The MP brigade provides comprehensive planning, C², and A/L support to assigned and attached subordinate units. The brigade also has the command and staff experience to coordinate and supervise HN security and law-enforcement activities.

11-51 The MP brigade headquarters provides senior MP leadership and the communications capabilities required to direct a variety of functional elements—CSS, PSYOP, public affairs, and combat-arms augmentation—in support of joint or unilateral TF operations. At authorized level of organization (ALO) 1, the MP brigade headquarters has an SJA section to coordinate the legal and jurisdictional issues inherent to stability and support operations. The brigade headquarters also has an S5 section and a liaison capability to coordinate support and assistance to HN agencies, friendly forces, other US forces, DOS personnel, and nongovernmental or private volunteer organizations.

11-52 The MP brigade TF (MPBTF), with its robust capabilities and low force signature, is well suited for the unique mission requirements and sensitivities of stability and support operations. The MPBTF can be employed as part of a combat TF in high-threat, opposed-entry operations or as the lead TF for a low-threat, unopposed-entry operation. The following are examples of previous MPBTFs and the operations in which they participated:

- **Operation Provide Comfort** The 18th MP Brigade deployed to northern Iraq to provide humanitarian assistance and protection to the Kurds.
- **JTF Los Angeles** The 49th MP Brigade (NG) provided civil-disturbance assistance to Los Angeles in the aftermath of the Rodney King trial.
- **Operation Hawkeye** The 16th MP Brigade and units of the 89th MP Brigade provided security, protection, and humanitarian

assistance to the population of Saint Croix in the aftermath of Hurricane Hugo

- **JTF Andrew** The 16th MP Brigade provided humanitarian assistance in the aftermath of Hurricane Andrew
- **Operation Sea Signal.** The 89th MP Brigade deployed to Guantanamo Bay, Cuba, to provide humanitarian assistance to Haitian migrants
- **Operation Restore Democracy.** The 16th MP Brigade deployed to Haiti to provide humanitarian assistance

11-53 *Early deployments of the MPBTF headquarters or a mission-tailored portion of the headquarters positions a senior, effective MP C² headquarters to respond to all MP requirements. It can assist in the coordination with the media, governmental and nongovernmental agencies, and other forces, and it can coordinate civil-military aspects of the operation. The MP brigade headquarters can assimilate and employ additional forces without degrading operations. The augmentation of brigade headquarters is driven by METT-TC. With the brigade headquarters in place, subordinate or supporting units can be significantly expanded without the loss of C². In essence, little or no loss in operational momentum occurs when the C² element deploys first.*

11-54 The MP LRP section of the MP brigade headquarters colocates and works with the higher headquarters' G3/Operations Directorate (J3) plans element. This allows the MP LRP to incorporate MP operations effectively into higher-level planning, and it enables an efficient transition to field operations. Also, because in peacetime this section functions as a PM cell, it provides the PM with efficient and effective technical support during stability and support operations. As the operations approach termination or enter sustainability and fewer forces are required, the brigade headquarters can redeploy, leaving a battalion TF in charge of MP forces

MP BATTALION TF

11-55 The MP battalion (CS) provides command, control, and support for assigned MP companies (CS). MP battalions (CS) are best employed as part of a TF—either as part of a combat TF (high threat, opposed) or a support TF (low threat, unopposed). With sufficient augmentation, the battalion can provide the logistical, administrative, personnel, and operational support needed to lead a diverse TF. During stability and support operations, an MP battalion TF may be placed under the OPCON of a brigade-size TF (MP or non-MP) or a division TF. If placed under the OPCON of a division TF, both the division PM and the MP battalion commander will synchronize their efforts to maximize the employment of available divisional and nondivisional MP assets in support of the division commander's concept of operations

11-56 As with the MPBTF, the MP battalion's contributions to stability and support operations are not a new concept. The following are examples of previous battalion TFs and the operations in which they were involved

- **Cuban Refugee Movement** The 519th, 716th, 720th, and 759th MP Battalions deployed for humanitarian-assistance operations
- **Operations Restore Hope and Continued Hope** The 720th MP Battalion provided humanitarian assistance in Somalia

- **Operation Sea Signal.** The 720th MP Battalion deployed to Guantanamo Bay, Cuba, to conduct humanitarian-assistance operations for Haitian migrants. Later, the 716th and 759th MP Battalions also deployed to Guantanamo Bay to perform like functions for the Cubans.

MP COMPANY IN STABILITY AND SUPPORT OPERATIONS

11-57 The MP company is the MP Corps's primary mission performer. It executes a wide variety of missions. In these operations, MP companies—

- Provide mobility support for both vehicles and personnel
- Provide AS, including security for critical personnel, sites, cargoes, and railways
- Secure, safeguard, shelter, and control detainees and dislocated civilians
- Restore order in civil disturbances and conduct PRC operations
- Carry out limited L&O operations
- Provide liaison, coordination, and training for all aspects of law enforcement to other agencies
- Conduct police-intelligence collections and disseminate information to the populace, friendly forces, and other HN agencies
- Support force protection and security

11-58 The MP company possesses robust mobility, lethality, and communications. Each of the MP companies' three-man teams are equipped with either a high-mobility, multipurpose, wheeled vehicle (HMMWV), an up-armored HMMWV, or an armored security vehicle (ASV), an AN/VRC 91 radio, a Light-Vehicle Obscuration Smoke System (LVOSS), an MK-19 grenade machine gun, a squad automatic weapon (SAW), two M-16 or M-4 rifles, an M203 grenade launcher, and a 9-millimeter pistol as a side arm for each team member. In addition to conducting combat operations, the MP company commander has the capability to conduct limited L&O operations (desk and investigative operations). With a tremendous operational reach, the MP company will displace its platoons as far as possible to accomplish all of the MP functions.

MP I/R UNITS IN STABILITY AND SUPPORT OPERATIONS

11-59 The MP I/R units are specifically equipped and trained to support, safeguard, account for, and provide proper and humane treatment for EPWs/CIs, US military prisoners, or dislocated civilians. When conducting dislocated-civilian operations, the MP I/R units support and interact with civil-affairs and PSYOP units who are responsible for monitoring and handling dislocated civilians. Should more than one category of personnel have to be supported, the MP I/R units will establish separate compounds for each to preclude contact with other populations. When operation of the facility is going to be more than a short-term endeavor, the intent is to involve (as appropriate) NGOs, IHOs, HN authorities, and dislocated civilians in the administration of the facility. The tasks performed by MP I/R units for stability and support operations are basically the same as those for war, but the operations and procedures are modified according to the operational

environment and the categories of people to be housed in the facility (see FM 19-40)

11-60 Criminal detainees (who are detained against their will) are subject to controls and procedures that closely parallel those used for EPWs/CIs. The primary emphasis is on guarding and preventing escape until their disposition is determined by recognized civilian judicial/law-enforcement authorities. When the operation is conducted outside of the US and its territories, criminal detainees are treated according to established legal procedures.

11-61 Dislocated civilians (who are being assisted rather than detained) are provided aid, shelter, and protection. The emphasis is on protecting them from harm by natural forces or hostile personnel. A special category of personnel arises when the MP I/R unit is required to house personnel that are dislocated civilians but who must be detained against their will. Such is the case of mass migrants who flee their countries and find themselves under US custody while formal proceeding guidance is being developed. In this case, MP I/R units must be sensitive to the situation and attempt to strike a balance between security, shelter, protection, and detention procedures.

11-62 Military detainees (who are detained against their will) are subject to controls and procedures that closely parallel those used for EPWs/CIs. In stability and support operations, US forces detain opposing-force military personnel. Without a formal declaration of war, opposing military personnel who are captured cannot be categorized as EPWs. However, they are afforded many of the EPW's rights and privileges under the Geneva convention. Such a situation occurred during Operation Just Cause when PDF personnel were detained by US forces.

11-63 In an operational environment in which hostile groups are engaged against one another, an I/R facility may be set up to protect one group from another. In this case, the facility's purpose is to shelter, sustain, account for, and protect its dislocated civilians from the hostile group. The MP I/R units and other supporting units concentrate on providing AS to protect the facility from direct fire. Other MP or combat forces provide protections beyond the direct-fire zone. Accountability for the dislocated civilians is coordinated with the SJA and civil affairs. They focus on maintaining a record of the people in the facility and their physical conditions. In operations in which no hostile groups are engaged (such as natural disasters), the I/R facility may be set up to provide shelter, sustain, and account for personnel. There may not be a need for external security personnel.

11-64 The MP I/R C² structure for stability and support operations is based on METT-TC. The nature and complexity of the mission, the number and types of detainees, and the operational duration should be considered. At one end of the operations spectrum, an MP brigade (I/R) may be required, while at the other end, an MP battalion (I/R) may be assigned to an MP brigade (CS).

Chapter 12

Force Protection

There is no more important responsibility than force protection. It is an inherent command responsibility and must be fully integrated into every unit's mission. A commander must continually review his unit's force-protection posture and crosswalk it with current and changing policy and threat levels. Force protection demands the personal involvement of commanders to ensure the best possible security consistent with the threat to personnel and mission-essential resources.

AR 525-13

Force protection consists of those actions that prevent or mitigate hostile actions against DOD personnel (to include family members), resources, facilities, and critical information. It coordinates and synchronizes offensive and defensive measures to enable the joint force to perform while degrading opportunities for the enemy. It includes air, space, and missile defense, NBC defense, antiterrorism, defensive-information operations, and security to operational forces and means.

OVERVIEW

12-1 The MP contribute significantly to the Army's overall force-protection effort. They are directly responsible for executing certain security-related measures (law enforcement and physical security) and for providing support to others (HRP security and antiterrorism), all of which contribute to force protection. Commanders use the Army's risk-management methodology and established security programs and capabilities within US forces to help prioritize and implement force-protection measures.

SUPPORT TO FORCE PROTECTION

12-2 MP support to force protection is accomplished under the leadership of the respective command's PM. It is accomplished mainly through an active role in physical security, HRP security, law enforcement, and antiterrorism.

PHYSICAL SECURITY

12-3 Physical security is an integral part of security of forces and means. Physical-security measures deter, detect, and defend against threats from terrorists, criminals, and unconventional forces. These measures include—

- Fencing and perimeter standoff space
- Lighting and sensors

- Vehicle barriers
- Blast protection
- Intrusion-detection systems and electronic surveillance
- Procedural measures such as security checks, training and awareness, property accountability/inventory requirements, physical-security inspections of mission-essential or vulnerable areas (MEVAs), and physical-security surveys of installations

12-4 These physical-security measures are not exclusively peacetime measures. They are designed to protect US personnel and equipment regardless of the mission or the geographical location.

12-5 The MP support the commander's security of forces and means programs by—

- Controlling or monitoring installation, base, or base-cluster access or entrance points
- Monitoring intrusion-detection systems and providing a response force
- Conducting physical-security inspections
- Conducting perimeter security or site surveillance
- Recommending the placement of walls, berms, gates, or barriers around designated MEVAs, high-value areas, or perimeters
- Supporting the commander's risk-analysis effort
- Conducting roving patrols, checkpoints, or roadblocks
- Performing other physical-security measures as required by the commander

HRP SECURITY

12-6 The HRP security program provides additional security to designated individuals (and their families) whom by virtue of their rank, assignment, symbolic value, vulnerabilities, or location or a specific threat are at a greater risk than the general population. This security program is applicable across the full spectrum of military operations.

12-7 The MP support the commander's HRP security measures by—

- Conducting protective-service details for HRP (normally conducted by USACIDC special agents)
- Responding to duress alarms and intrusion-detection systems
- Conducting a PSVA (performed by the USACIDC)
- Employing MWDs
- Coordinating with local, state, and federal agencies as well as joint, multinational, and HN law-enforcement agencies
- Performing other HRP security measures as required by the commander

LAW ENFORCEMENT

12-8 The Army's law-enforcement program supports the security of forces and means through the prevention, detection, response, and investigation of

crimes. The MP, the USACIDC, and DOD police play a crucial role in the law-enforcement program. They provide a visible deterrent against a broad portion of the threat spectrum, investigate crimes, and provide an initial response force to threat incidents. As with the previous programs, the law-enforcement program is applicable anywhere across the spectrum of military operations.

12-9 The MP support law-enforcement operations by—

- Providing liaison teams with local, state, and federal agencies, HN police, and joint and multinational agencies
- Employing SRTs and hostage-negotiation teams (normally provided by the USACIDC)
- Providing traffic enforcement, MSR regulation enforcement, and other route-control measures
- Employing MWDs
- Conducting MP investigations (criminal and noncriminal)
- Conducting patrolling, AS, and surveillance measures
- Implementing applicable threat-condition (THREATCON) measures
- Conducting and implementing other law-enforcement measures as required by the commander

ANTITERRORISM

12-10 Terrorism is characterized as the unlawful use of violence or the threat of violence to coerce or intimidate a government or a society. Protection against a terrorist threat requires both an offensive counterterrorism capability and a defensive antiterrorism program. The primary focus of antiterrorism is on training and awareness and thorough planning. Antiterrorism is not a stand-alone program. It leverages other force-protection-related programs (such as physical security and law enforcement) to provide much of the physical defense against terrorism.

12-11 The MP support the commander's antiterrorist program by—

- Collecting CRIMINTEL (within the limits of AR 190-45)
- Responding to terrorist threats and incidents
- Performing aggressive patrols and R&S operations
- Detecting suspicious activities
- Enforcing joint and cooperative agreements with the FBI, the USACIDC, MI, and other pertinent agencies (home or abroad)
- Conducting information collection and dissemination
- Protecting critical assets, facilities, and personnel
- Performing other antiterrorism measures as required by the commander

Appendix A

Metric Conversion Chart

This appendix complies with current Army directives which state that the metric system will be incorporated into all new publications. Table A-1 is a conversion chart.

Table A-1. Metric Conversion Chart

<i>Metric to English</i>			<i>English to Metric</i>		
Multiply	By	To Obtain	Multiply	By	To Obtain
Length					
Centimeters	0.0394	Inches	Inches	2.54	Centimeters
Meters	3.28	Feet	Feet	0.0305	Meters
Meters	1.094	Yards	Yards	0.9144	Meters
Kilometers	0.621	Miles (stat)	Miles (stat)	1.5609	Kilometers
Kilometers	0.540	Miles (naut)	Miles (naut)	1.853	Kilometers
Millimeters	0.039	Inches	Inches	25.40	Millimeters
Area					
Square centimeters	0.1550	Square inches	Square inches	6.45	Square centimeters
Square meters	10.76	Square feet	Square feet	0.0929	Square meters
Square meters	1.196	Square yards	Square yards	0.836	Square meters
Volume					
Cubic centimeters	0.610	Cubic inches	Cubic inches	16.39	Cubic centimeters
Cubic meters	35.3	Cubic feet	Cubic feet	0.0283	Cubic meters
Cubic meters	1.308	Cubic yards	Cubic yards	0.765	Cubic meters
Milliliters	0.0338	US liq ounces	US liq ounces	29.6	Milliliters
Liters	1.057	US liq quarts	US liq quarts	0.946	Liters
Liters	0.264	US liq gallons	US liq gallons	3.79	Liters
Weight					
Grams	0.0353	Ounces	Ounces	28.4	Grams
Kilograms	2.20	Pounds	Pounds	0.454	Kilograms
Metric tons	1.102	Short tons	Short tons	0.907	Metric tons
Metric tons	0.984	Long tons	Long tons	1.016	Metric tons

Appendix B

Doctrine and Training Literature

Users of this manual must understand the elements of doctrinal literature and their relationship to each other. The commonly used terms doctrine and tactics, techniques, and procedures (TTP) are interrelated and mutually supportive, yet, each term has its own usage, level of detail, and place in the hierarchy of doctrinal publications. Because there is a close interrelationship, publications overlap in what they provide to the user. Figure B-1 illustrates the relationship of these doctrinal terms and publications.

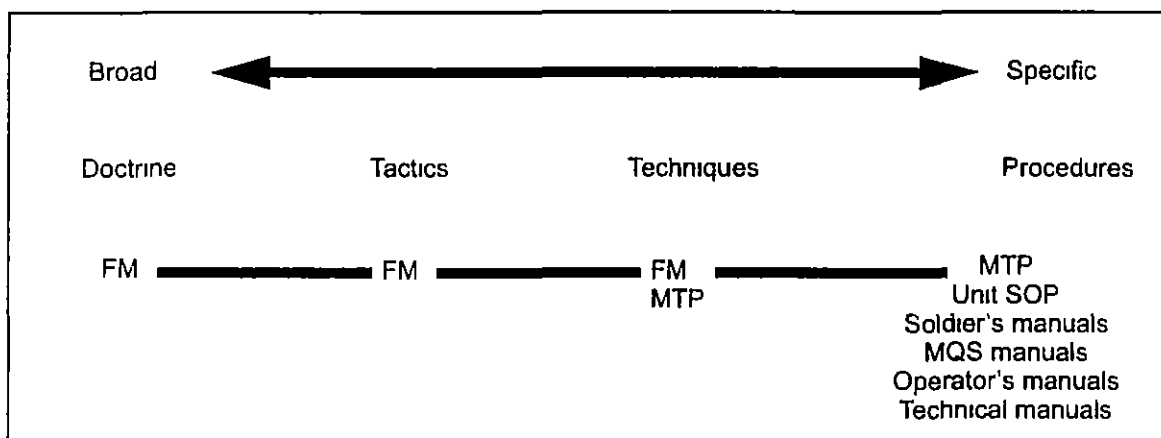

Figure B-1 Doctrinal and Training Literature

DOCTRINE

B-1 Doctrine is the body of fundamental principles by which the military guide their actions in support of national objectives. It is authoritative, but requires judgment in application. Doctrine provides the Army's fighting philosophy, establishes a common language, and structures the manner within which units plan and conduct combat operations.

B-2 Doctrine is not absolute, it is applied by the leader to meet the circumstances of the situation being faced. Doctrine provides for this flexibility with broad fundamentals and principles for conducting operations. Leaders well grounded in doctrine understand how to synchronize the elements of combat power and how to apply TTP using the assets available to accomplish the mission.

B-3 Doctrine is described in FMs. FM 3-0 defines the systems of war fighting practiced by the US Army. FMs 100-15 and 71-100 expand on this foundation. This manual describes the CS doctrine of the MP, it is the capstone manual for MP operations. It defines the role, operational requirements, functions, and C² relationships of MP units. This manual is not oriented on a specific organizational structure. Leaders at all levels apply this doctrine to their unique organizational and operational situations and use various tactics and techniques to accomplish the doctrine.

TACTICS

B-4 Tactics describe how the leader carries out doctrine (relating to the arrangement of forces for battle). Tactics include the—

- Employment of units in combat (to accomplish a mission assigned by the commander)
- Ordered arrangement and maneuver of units in relation to each other and to the enemy in order to use their full potential (a description of how the commander should arrange his forces and maneuver to accomplish a mission)

B-5 This is the part of doctrinal literature used for training in preparation for combat. Like doctrine, tactics presented in manuals are applied with judgment by the leader. The FMs prescribe "how to fight" and the mission training plans (MTPs) describe "what to train."

TECHNIQUES

B-6 Techniques are the methods of performing any act, especially the detailed methods used by troops or commanders in performing assigned tasks. Techniques describe the basic methods of using equipment and personnel. Techniques give details on how commanders actually carry out assignments. They improve the force's efficiency by ensuring the uniformity of action or by ensuring that the actions of various individuals and elements complement those of other individuals or elements.

B-7 The FMs and MTPs provide a description of techniques using the personnel and equipment available in actual organizations. These techniques show (at a more detailed level) how to use available assets to carry out tactics.

PROCEDURES

B-8 Procedures are the lowest level of detail. They address "how to" at the task level. Procedures are a particular course or mode of action that describe how to perform a certain task. Procedures include the—

- Standing methods used by units to accomplish tasks
- Operating procedures for weapons and equipment
- Crew drills
- Staff actions and coordination requirements
- Methods of target engagement by direct- and indirect-fire weapons

B-9 Procedures are building blocks of individual- and collective-task accomplishment that serve as the foundation of tactics and techniques. Procedures are explained in unit standing operating procedures (SOPs), MTPs, soldier's manuals, operator's manuals, technical manuals (TMs), and similar publications.

Appendix C

Battlefield Workload Analysis

With minor adjustments in the capability block, the BWA can be used to determine MP requirements for the division. A BWA work sheet is shown in Figure C-1. A separate matrix is prepared for each EAC and corps MP brigade. Figure C-2, page C-3, is a sample of a BWA matrix for a 3-division corps MP CS company.

Mission/Function ¹	Capability ¹	Workload ²	Rqmt	HN ¹⁸	US Rqmt	Risk ¹⁹	Mission Rqmt
Divisions supported ^d	1						
MMS	360 km MSR and ASR						
Refugees on control routes ⁴	150,000 per day						
AS—corps rural terrain ⁵	2,000 sq km						
AS—EAC rural terrain ⁵	3,000 sq km						
AS—urban terrain ⁵	800 sq km (urban)						
AS—USAF main opns base ⁵	1,000 sq km/USAF MOB						
AS—convoy escort ⁶	# hrs per convoy	# convoys					
AS—ammo security ⁷	1 3 modular ammo co						
	2 modular ammo co						
AS—pipeline security ⁸	400 km						
AS—EAC pipeline co ⁶	3						
AS—trains ⁹	7						
AS—small critical sites ¹⁰	12						
AS—major HQ security ¹¹	1						
AS—EAC port security ¹²	0 66 of port						
AS—combat operations	When required, assets are diverted from other missions.						
L&O—incident response ¹³	75,000 nondivision troops						
I/R—US prisoner detention ¹⁴	700						
I/R—EPW escort/corps ¹⁵	1,900 walking						
	2,500 by vehicle	Min 1 pl					
	3,800 by train						
I/R—EPW holding/corps ¹⁶	2,000	Min 1 pl					
Other assigned missions ¹⁷	Mission	Force size					
Totals²⁰							
Battalion HHD requirement = 0 199 x number of companies ²¹							

Figure C-1 Sample BWA Work Sheet

<p>NOTE: Workload + capability = doctrinal requirement - HN offset = US requirement - acceptable risk = mission requirement</p> <p>¹Mission/capabilities are as stated in section I of TOEs 19477L000 and 19677L000. The unit capability for each mission is what the unit can accomplish when performing no other mission (for example, if it is only doing MSR, the unit can cover 360 kilometers in a 24-hour period). Unless otherwise specified, the capabilities are the same at corps and EAC.</p> <p>²Workload is the amount (MSR or area) or number of supported units/facilities.</p> <p>³Corps support to each division is covered by allocating one MP company per supported division. Any additional support requirements should be based on a detailed division PM/MP mission analysis and included under other assigned missions.</p> <p>⁴Unless specifically tasked, the Army normally relies on HN support to manage refugees. Redirecting refugees from MSRs and keeping them off of MSRs is part of (as is straggler control and TCP) the mission and MSR workload. When assigned the mission, the capability is for control of refugees on established refugee control routes that are in addition to the MSRs.</p> <p>⁵Compute each square kilometer mission requirement separately. Do not compute the same terrain in more than one computation (for example, the area around the Air Force's main operating base (MOB) is not included with either rural or urban square kilometers).</p> <p>⁶Convoy-escort capability is not stated in the TOE and is an AS function rather than an MMS function. Determine the average number of teams per mission and the average number of simultaneous missions. Multiply the number of teams required per mission by 0.028, then multiply the result by the number of simultaneous missions to determine the total requirement. State the number of teams per convoy and the number of convoys, then convert the force size to a 3-decimal-place company equivalent. Each additional team, squad, and platoon equivalent equals 0.028, 0.083, and 0.25 respectively.</p> <p>⁷Security for modular ammo companies (ASPs) supporting divisions is three platoons and is normally conducted directly behind the division (corps forward). However, METT-TC may require the ammo units to move into the DRA. In this case, corps units should be attached to the division for the duration. Security for corps storage areas (CSAs) and theater storage areas (TSAs) is one MP company per two ammo companies. Security is provided on an area-support basis in the form of screening, with limited fixed posts.</p> <p>⁸The EAC petroleum terminal/pipeline operating company manages the EAC pipeline that is normally laid adjacent to MSRs. Pipeline security is inherently provided by the MP operating on the MSRs. Unless the pipeline is not near the MSR, MP support is only allocated against the EAC petroleum terminal/pipeline operating company's bulk storage facilities. Security is provided on an area-support basis in the form of screening, with limited fixed posts.</p> <p>⁹Train security is normally an EAC mission. This capability equates to simultaneously providing five MP teams to each of seven trains. Actual workloads and requirements are computed in the same manner as a convoy escort.</p> <p>¹⁰Small critical facilities are normally defined as key MSR bridges and tunnels and communication nodes that may require additional security.</p> <p>¹¹The major headquarters are corps, COSCOM, TSC, unified command and, if directed, the JTF. The ASCC depends on the MP to provide security for two CPs. The ASCC requirement is an additional three platoons to support a second CP.</p> <p>¹²The requirement for one seaport is 1.5 companies.</p> <p>¹³Teams provide incident response, crime-scene security, and traffic control. They also assist L&O detachment teams and CID investigators.</p> <p>¹⁴For deliberate planning in support of an OPLAN, personnel to be confined will normally be held by either the unit or the EAC I/R MP battalion performing the confinement mission. This does not preclude a requirement for the echelon PM to operate a field detention facility until prisoners are released back to their units or evacuated to the EAC confinement facility.</p> <p>¹⁵The primary mode is vehicle (back-haul doctrine). Regardless of the mode, a minimum of one platoon (0.25 requirement) per supported division is allocated for EPW escort from the division central collection point (DCCP) to the corps holding area (CHA). Because the actual number of EPWs is unknown, coupled with no time/distance study for each supported division, one platoon per division provides a minimum capability for continuous evacuation within the stated doctrinal timeline (evacuate to the CHA within 12 hours of arrival at the DCCP).</p> <p>¹⁶At a minimum, one platoon (0.25 requirement) is allocated to operate the CHA (provides the capability to hold 500 EPWs at any given time).</p> <p>¹⁷Add any additional continuous missions assigned by the echelon commander not covered above. Examples include VIP escort/security for other than the CG and the deputy commanding general (DCG) of major headquarters, screening exposed corps flanks, and increasing teams per mission/function which decreases doctrinal capability (for example, permanent TCPs or checkpoints). Each additional team, squad, or platoon equivalent equals 0.028, 0.083, and 0.25 respectively.</p>

Figure C-1 Sample BWA Work Sheet (continued)

¹⁸For each mission/function, any workload either fully or partially accomplished by the HN is subtracted from the doctrinal mission requirement. Enter the MP company equivalent offset and subtract from the doctrinal requirements to determine the US requirement.

¹⁹For each mission/function, if the operational/MP commander will accept mission risk, subtract the MP company equivalent to determine the mission requirement.

²⁰Add columns to determine the total doctrinal company requirement, HN offsets, US requirement, acceptable risk, and mission requirement to support the operation/AO. Round the requirement to the nearest whole number (0.4 or fewer rounds down, 0.5 or greater round up).

²¹Determine battalion HHD requirements by multiplying the company requirements by 0.199 and rounding.

Figure C-1. Sample BWA Work Sheet (continued)

Mission/Function	Capability	Workload	Rqmt	HN	US Rqmt	Risk	Mission Rqmt
Divisions supported	1	3	3 000		3 000		3 000
MMS	360 km MSR and ASR	1,050	2 917		2 917		2 917
Refugees on control routes	150,000 per day	25,000	0 167	0 167	0 000		0 000
AS—corps rural terrain	2,000 sq km	6,500	3.250		3 250	0 500	2 750
AS—EAC rural terrain	3 000 sq km						
AS—urban terrain	800 sq km (urban)	1,500	1 875		1 875	0 500	1 625
AS—USAF main opns base	1,000 sq km/USAF MOB	1,000	1 000		1 000		1 000
AS—convoy escort	25 units per convoy	4	0 560		0 560		0 560
AS—ammo security	13 modular ammo co	3	2 308		2 308		2 308
	2 modular ammo co	1	0 500		0 500		0 500
AS—pipeline security	400 km						
AS—EAC pipeline co	3						
AS—trains	7						
AS—small critical sites	12	9	0 750		0 750	0 250	0 500
AS—major HQ security	1	2	2 000		2 000		2 000
AS—EAC port security	0.66 of port						
AS—combat operations	When required, assets are diverted from other missions						
L&O—incident response	75,000 nondivision troops	45,000	0 600		0 600	0 300	0 300
I/R—US prisoner detention	700						
I/R—EPW escort/corps	1,900 walking						
	2,500 by vehicle	Min 1 plt/div	0 750		0 750		0 750
	3,800 by train						
I/R—EPW holding/corps	2 000	Min 1 plt	0 250		0 250		0 250
Other assigned missions	PSD for Corps CofS	1 sqd	0 083		0 083		0 083
	Flank screen	1 plt	0 250		0 250		0 250
Totals			20	0 177	20	1 3	19
Battalion HHD requirement = 0.199 x number of companies			4		4		4
NOTE: Workload ÷ capability = doctrinal requirement - HN offset = US requirement - acceptable risk = mission requirement							

Figure C-2. Sample BWA Matrix

Appendix D

Automated Information Systems in Support of Battle Command

As the MP Corps continues to advance into the twenty-first century, it must continue to pursue and stay in tune with the Army's initiative to acquire advanced technologies and operational concepts. This will give MP soldiers on the battlefield an information advantage that is critical for successful performance of their functions. The following information opens a window into the near future and explains some of the automation initiatives that will enhance the Army's and the MP Corps's soldiers.

ARMY INFORMATION SYSTEMS

D-1 The Global Command and Control System (GCCS) is the midterm solution and the bridge to the concepts outlined in the concept of command, control, communications, computers, and intelligence for the warrior (C4I²W). The GCCS's core consists of the basic functions required by the war fighter to plan, execute, and manage military operations. The Army's selected C² system is the Army Battle Command System (ABCS).

D-2 The ABCS integrates the C² systems found at each echelon—from the ground-force component commander at the theater or JTF level to the individual soldier or the weapons platform. Whether ARFOR are deployed for land combat or are conducting peace operations, providing humanitarian assistance, or giving aid to civil authorities, the ABCS supports the mission by integrating the battle-space automation systems and communications that functionally link strategic and tactical headquarters. The ABCS is interoperable with joint and multinational C² systems at upper echelons across the full range of C² functionality, and it is vertically and horizontally integrated at the tactical and operational levels. The ABCS has three major components—

- The Global Command and Control System—Army (GCCS-A)
- The Army Tactical Command and Control System (ATCCS)
- The FBCB2

GLOBAL COMMAND AND CONTROL SYSTEM—ARMY

D-3 The GCCS-A is the Army's component of the Joint GCCS. It was built from application programs developed by the Army Worldwide Military Command and Control System [WMCCS] Information System (AWIS), namely the—

- Strategic Theater Command and Control System (STCCS)

- Theater Automated Command and Control Information Management System (TACCIMS)
- EAC portion of the Combat Service Support Control System (CSSCS) (CSSCS/EAC)

D-4 The GCCS-A is required in the MP LRP, S1, S3/NBC, and S4 sections within the MP brigade at EAC, in the Assistant Chief of Staff, G1 (Personnel) (G1), the G3, and the Assistant Chief of Staff, G4 (Logistics) (G4) sections within the MP command (I/R), and in the S1, S3, and S4 sections within the MP brigade (I/R)

ARMY TACTICAL COMMAND AND CONTROL SYSTEM

D-5 The ATCCS embodies the commander and his staff and the doctrine, procedures, and tools used to command and control forces on the tactical battlefield. The ATCCS's functional subsystems provide tools to support the C² process across the spectrum of low- to high-intensity conflicts worldwide, for MOOTW, and for combat, CS, and CSS functional areas at corps-and-below units. The ATCCS provides a common set of C² tools and functions for commanders that extends the ATCCS to the battalion level. The component's ATCCS's are the—

- Maneuver Control System (MCS)
- All-Source Analysis System (ASAS)
- Advanced Field-Artillery Tactical Data System (AFATDS)
- Air- and Missile-Defense Planning and Control System (AMDPCS)
- CSSCS

D-6 The FFCB2 provides situational awareness and C² to the lowest tactical echelons. It facilitates a seamless flow of battle-command information and situation-awareness information across the battle space at brigade and below on Army platforms.

FORCE XXI BATTLE COMMAND—BRIGADE AND BELOW

D-7 The FFCB2 system, a battle-command information system, provides the technology to complete the ABCS information flow process from brigade to platform and across all platforms within the brigade TF. The FFCB2 enables commanders to remotely operate and maintain ABCS database connectivity (regardless of the command vehicle) and to digitally control and monitor their subordinate units' statuses and positions. Interoperable FFCB2 systems will enhance the battle commander's ability to have a detailed picture of the battlefield (situational awareness), to maximize force survivability, and to facilitate battlefield synchronization to reduce or destroy the enemy's capability to fight. The FFCB2 relies on integrating, processing, and moving information in a digital form. To support projections of future conflicts with an accompanying increase in the tempo of battle, the FFCB2 must be able to obtain information contained in databases from higher, lower, and adjacent elements without formally requesting that information through command channels. The war fighter requires the ability to pull data from all battlefield-system databases to keep current with the rapid changes caused by the dynamics of battle. The FFCB2 is required for divisional MP company commanders, PMs, platoon leaders, teams, and squads.

MANEUVER CONTROL SYSTEM

D-8 The MCS is the ABCS's horizontal and vertical integrator. The MCS will enable commanders and their staffs to collect, coordinate, and act swiftly on near-real-time battlefield information. It will quickly, accurately, and automatically move tactical information on the battlefield. This allows a commander to readily access information and display current situation reports (SITREPs) that assess enemy strength and movement as well as the status of friendly forces. The MCS will then aid the battle staff in rapidly disseminating the commander's orders. It is intended to provide two major functional capabilities—maneuver functional-area control and force-level information. The MCS is the ATCCS's functional subsystem that—

- Supports the combined-arms force commander directly by providing automated support for planning, coordinating, controlling, and using maneuver functional-area assets and tasks
- Coordinates and synchronizes supporting arms in conducting operational planning, field operations, and training

D-9 The MCS is required for division PM operations sections, company CPs at echelons corps and below (ECB), MP battalion commanders, S3 sections at corps, MP brigade commanders, and corps MP LRP and S3 sections

ALL-SOURCE ANALYSIS SYSTEM—REMOTE WORK STATION

D-10 The ASAS—remote workstation (RWS) subsystem will operate within the existing intelligence and electronic warfare (IEW) battlefield operating system (BOS) and ABCS architectures to provide automation support to G2/S2 intelligence staff elements and other designated intelligence organizations from the maneuver battalion through EAC. It will operate at the security level appropriate to its echelon, mission, and functions. It assists the G2/S2 in providing IEW support to the commander and other staff elements in planning, coordinating, and conducting current and future tactical operations. It interfaces with the sensitive compartmented information (SCI) analysis and control element (ACE) subsystem to provide operational guidance and to exchange IEW information and products. It also operates as the technical control portion of the IEW C² node of the ABCS to provide current IEW and enemy-situation information to the force-level information database for access and use by ABCS users. Two RWSs are also provided to the brigade analysis control team (ACT) of the DS MI company to process data input from DS collection systems, to filter intelligence data from broadcast systems, and to pass tactically relevant enemy-situation information or situation-development data to the brigade S2's RWS. The ASAS-RWS is required in the S2 section of the CID group, the S2/S3 section of the CID battalion, the G2 section of the MP command (I/R), the S2 section of the MP battalion (I/R), and the S2 section of the MP battalion and brigade at all echelons.

COMBAT SERVICE SUPPORT CONTROL SYSTEM

D-11 The CSSCS will function as an integral part of the ATTCS. It is designated as an information system with the capability to rapidly collect, analyze, and disseminate logistical, medical, and personnel information to accelerate and improve decision making by CSS and force commanders. It also

enables the rapid exchange of C² information with other battlefield functional areas (BFAs) through automated interfaces. The system will process unclassified through secret information. The CSSCS will be employed in all divisions, corps, EAC, separate brigades, and armored cavalry regiments. The MP require CSSCS functionality in all S1 and S4 sections in battalion or higher organizations except where the GCCS-A is required as stated above.

TRANSPORTATION COORDINATOR AUTOMATED MOVEMENT SERVER

D-12 The Transportation Coordinator Automated Movement Server (TC-AIMS II) is used by transportation agents and deploying units of each service to automate the processes of planning, organizing, coordinating, and controlling deployment and redeployment operations worldwide during peace as well as contingencies. The TC AIMS II will link all DOD-component unit movements with the installation transportation officer/traffic-management officer (ITO/TMO). This will provide the capability to plan and execute deployments rapidly to meet CINC-required arrival and departure dates. The TC AIMS II will also provide the ITO's/TMO's day-to-day traffic management functions and the theater transportation managers with the capabilities to use theater common lift assets effectively. The TC AIMS II will also allow CSS organizations and supporting commands to sustain the force and perform effective movement control, coordination, distribution, and sustainment once in theater. This is also defined as transportation movement and support of DOD personnel and cargo during all phases of military operations in all environments (including RSOI and battlefield operations). The TC AIMS II's functionality is required at all division PM operations and S3 sections within MP battalions and brigades to facilitate MSR regulation enforcement. Additionally, MP companies, battalions, brigades, and commands require the TC AIMS II to plan, organize, coordinate, and control deployments and redeployments.

GLOBAL COMBAT SUPPORT SYSTEM—ARMY

D-13 The GCCS-A is an integrated logistical support system with accompanying hardware that will connect the service's supply, finance, transportation, maintenance, and personnel databases. Under this system, the Army will integrate 13 Legacy tactical logistics systems and will eventually interface with the service's wholesale logistics systems as well as the consolidated logistics systems of the other services and the DOD. The system is critical for modernizing automation, for reducing logistical footprints in theaters, and for expanding war fighters' capabilities. The system will also replace the *Standard Army Management Information System* (STAMIS). The GCCS-A is required at all MP division company CPs and MP battalion and brigade S4 sections. Additionally, it is required at all supply functions within MP detachments that support I/R missions.

MILITARY POLICE AUTOMATED SYSTEMS

D-14 In an effort to maintain an information advantage and to acquire advance technologies and operational concepts, the MP Corps has acquired the following systems:

- The Military Police Management Information System (MPMIS) and its subsystems
- The CID's automated systems and their subsystems

MILITARY POLICE MANAGEMENT INFORMATION SYSTEM

D-15 The MPMIS is a DA-mandated reporting system that does not interface with the ABCS. The MPMIS provides automated tools for MP records management and reporting. It reduces the administrative burden on the PM's staff. It increases the awareness of problem areas by managing crime information. The MPMIS consists of the following elements:

- **Offense Reporting Systems Windows (ORS-2W).** The ORS-2W provides automation support to track and report complaints, criminal incidents, and traffic incidents. It incorporates the CRC, the federally mandated National Incident-Based Reporting System (NIBRS), the DOD-mandated Defense Incident-Based Reporting System (DIBRS), the military community (MILCOM), and the installation's data requirements. The ORS-2W's functionality is required at PM activities at all echelons of command within the Army.
- **Correctional Reporting System (CRS-3).** The CRS-3 provides automation support to track and report inmates and corrections staff at all Army-controlled correctional facilities.
- **Security Management System (SMS).** The SMS provides automated support to assist physical-security inspectors and force-protection officers in reporting inspections and surveys. It tracks intrusion-detection devices and MWD training and health requirements.
- **Vehicle Registration System (VRS).** The VRS provides installations with an automated means to track vehicle, weapon, and bicycle registrations.
- **Prisoner-of-War Information System (PWIS-3).** The PWIS-3 provides the automated means of tracking an EPW's status from capture through release. This system is required at all EPW management activities.

CID AUTOMATED SYSTEMS

D-16 The Headquarters (HQ) USACIDC mandates CID automated systems. Similar to the MPMIS, it does not interface with the ABCS. The system facilitates data-collection efforts within the command. The CID's automated systems consist of the—

- **Automated Criminal Investigative Reporting System (ACIRS).** The ACIRS supports management and data-collection functions at the CRC and HQ USACIDC. It supports the following:
 - Maintaining investigative data
 - Conducting agent investigative activities
 - Reporting investigative data
 - Managing the investigative processes
 - Conducting criminal-activity analyses

- **CRIMINTEL.** Data sources for CRIMINTEL include MP reports, CRIMINTEL reports and bulletins, reports of investigation, crime-prevention surveys, case files, collection folders, raw-data folders, significant data files, and target-analysis files. The CRIMINTEL interfaces with the ACIRS, but it does not share CRIMINTEL products.

Appendix E

Police Information Assessment Process

The PIAP differs somewhat from the tactical IPB. While the IPB allows the maneuver commander to see the effects that a variety of factors may have on his forces, the PIAP looks beyond this approach to determine how other relevant information may impact his forces. This information may be obtained from police or criminal actions or incidents encountered during the performance of MP functions.

IMPLEMENTATION

E-1 The PIAP is not a substitute for the IPB. MP leaders must continue to rely on the IPB and to use its estimates as a starting point for the PIAP. However, the PIAP is a dynamic and continuous cycle that complements the IPB (Figure E-1). The following paragraphs represent the doctrinal approach to implementing the PIAP. These steps provide the basic foundation to the process. They are not exclusive; the successful development of the PIAP will depend on the MP leader's ability to apply the process to his specific environment, METT-TC, and the commander's priorities.

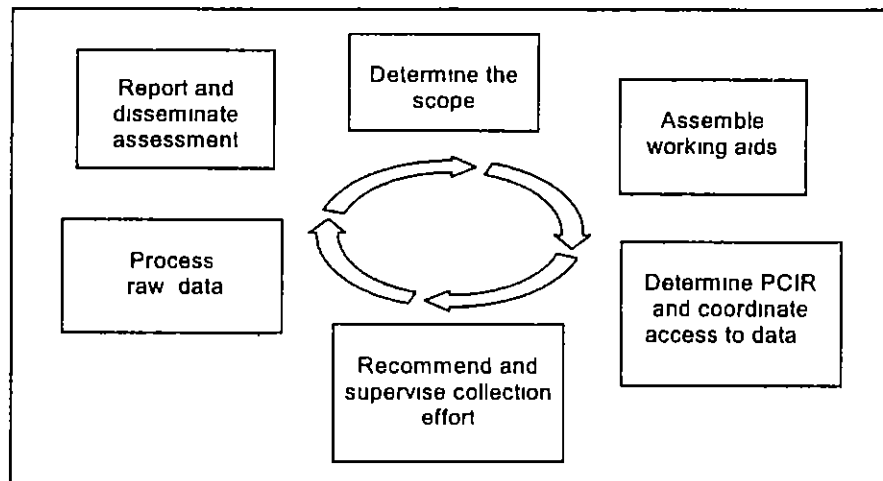

Figure E-1. The PIAP

DETERMINE THE SCOPE OF THE PIAP

E-2 While determining the scope of the PIAP might sound simple, it is one of the most crucial elements of the entire process. It entails identifying what you want to be the end result of your PIAP. To help determine the scope of the PIAP, MP leaders must perform the following subtasks:

- **Conduct a mission analysis** A detailed mission analysis will ensure that all available resources are focused toward one goal. The more specific the mission is, the more focused and productive the effort. This involves more than just looking at the mission statement, the commander's intent, and the concept of operations. It involves translating the mission and situation into easily understood, manageable goals. The following are examples of these missions:
 - Identifying criminal threats from local national to US Army logistics operations within the port of Mogadishu, Somalia
 - Determining the impact of gang violence on US forces operating in the vicinity of Camp Bondsteel, Kosovo
 - Determining how rioters' violence will affect force protection before deploying forces to Los Angeles, California
 - Determining the status of public service agencies (such as the police, the fire department, and the emergency medical services [EMS]) in Homestead, Florida, after the city was struck by Hurricane Andrew

NOTE: As you can see from the examples, these missions are quite specific. In all likelihood, it would be necessary to establish several different PIAP missions to adequately protect Army elements operating in the MP's AOR.

- **Prioritize missions** MP leaders must prioritize each PIAP mission since MP resources will probably be limited. The commander's intent is the key factor for determining priorities. When the commander's most important mission has been determined, MP leaders must decide how they can contribute to the overall success of that mission.
- **Determine the AO** Generally, the AO is a geographical area (including the airspace above) usually defined by lateral, forward, and rear boundaries assigned to a commander. MP leaders must know where major units are located and how the characteristics of the location may impact ongoing operations. For example, units in direct contact with the enemy or isolated from the local population are less likely to be the target of a PIAP mission than those units adjacent to great population centers or in rest and relaxation centers.
- **Determine key terrain** Key terrain is any locality or area that affords a marked advantage to the retaining side.
- **Determine the AOI** An AOI is the area of concern to the commander. This includes the area of influence and the areas adjacent thereto and extending into enemy territory and to the objectives of current or planned operations. A thorough understanding of the AOI may help predict potential threat actions. For example, how far are local agitators and ringleaders willing to travel to interfere with US operations in Pristina, Kosovo? Would they go to other US compounds?
- **Determine required information products/sources** The desired end-state product must be decided. Should it be a report? An updated SITREP? An upgrade in force-protection measures? Or a combination of products? It should also be determined who can provide the best

information (the CID, MI, the local police chief, or joint, interagency, or multinational agencies)

ASSEMBLE WORKING AIDS

E-3 During this step, MP leaders assemble the necessary graphic and nongraphic aids and information that will help them accomplish their mission. The CID and the MP may form an analysis team to track and analyze police information that might assist tactical operations or population-control operations. Working aids include, but are not limited to—

- **Maps.** Besides the standard military maps that depict the military AOs, the MP must attempt to procure indigenous maps of AOs. Detailed city and street maps will prove to be invaluable even if they are in a foreign language.
- **Language aids.** Phrase books and translation dictionaries cannot take the place of intensive language training, but they are better than nothing. These are essential even if the MP have assigned interpreters.
- **Open-source information.** This can cover an extensive range of invaluable information, but it should be available from a variety of sources. Examples include—
 - Demographic information on the HN population
 - Societal information on the HN
 - The locale and disposition of HN police forces
 - Historical crime data of the area
 - Environmental information (terrain and weather factors)
 - Local newspaper articles
 - Internet sources on all of the above

NOTE. Sources for this type of information can come from intelligence estimates provided by the higher headquarters' S2/G2, other military units, or the HN.

- **OPSEC information.** This information includes the disposition of US forces (to include MP, MI, CID, and other services' investigating units) deploying or being used within the AO.
- **Other working aids.** These may include items such as computers, printers, boards, and acetate that will be necessary depending on the missions the MP are undertaking.

DETERMINE INFORMATION REQUIREMENTS AND COORDINATE ACCESS TO DATA

E-4 Once the mission analysis is completed, the next step is to determine if there are information gaps. An information gap is a missing piece of information that is critical to the analysis. MP leaders must identify and prioritize the gaps using the time, the available resources, and the commander's intent. Once an information gap is identified, it becomes PCIR. Examples of PCIR are as follows:

- Where is the nearest police station, and how did they handle a certain problem?

- What is the composition of the two gangs operating in our AO, and how can they influence US operations?
- Why is river-crossing point Bravo a danger to US crossing forces? Why are local rioters disrupting only US operations on the east bank?

E-5 The next step is to determine if PCIR can be answered with data already available. To do this, the available military and nonmilitary sources must be identified. Some sources may include—

- **USACIDC.** The USACIDC is responsible for programs such as combating terrorism, CRIMINTEL, personal-security assessment, crime analysis, and LOGSEC threat assessment. Some of the information gathered by the USACIDC (although releasable under existing controls and restraints) may help with the PIAP mission. In fact, USACIDC special agents may already be working in the AO and may be available to help the MP with the collection effort.
- **MI element.** Like the USACIDC, the MI element operating in the AO may have come across a piece of information (police or criminal) that may help accomplish the PIAP mission. The MP must make daily contact with the S2/G2 and coordinate access to invaluable information. As with the USACIDC, available intelligence information may only be releasable under strict controls and restrictions imposed by the commander.
- **Other MP units.** Coordination with an adjacent MP unit may prove to be beneficial, especially if the other MP unit has conducted a similar PIAP mission or has conducted operations in the AOI.
- **HN law-enforcement agencies.** Local law-enforcement agencies will provide the essential populace knowledge otherwise not available to US forces. Chiefs of police, sheriffs, and other key community leaders may help MP leaders fill the information need of the PIAP mission.
- **Joint, interagency, and multinational forces.** Close and effective liaison with these elements will result in quick access to information that can produce the same benefits as the agencies listed above.

NOTE. If, after consulting with all available sources, the PCIR is not resolved, the MP leader must decide the best collection effort to solve the PCIR.

RECOMMEND AND SUPERVISE THE POLICE/CRIMINAL COLLECTION EFFORT

E-6 The collection effort is the means by which specific PCIR will be met. This implies developing a collection strategy, tasking specific collectors, and supervising the collection effort.

- **Develop a collection strategy.** After a thorough study of the availability, capability and disposition of the potential collecting resources, MP leaders select which asset is better suitable to perform the mission. Are organic MP the best collectors for this mission? Or do we need to request support from USACIDC units? What unique or organic capabilities do each bring to the effort? Which MP function is the best? Do we conduct MMS, AS, or L&O operations? Part of the collection strategy includes coordinating with the S2/G2, the SJA, the

CID, and other agencies before launching the collection effort. This coordination will eliminate duplication of effort, interference with an ongoing effort, or stepping out of legal limits.

- **Task or request specific collectors.** The missions that will be tasked to respective collectors must be determined. Information collectors can be tasked with more than one mission at a time. However, it is imperative that their tasks be prioritized based on mission requirements and time available. The appropriate tasking or request chain must be used to request an MP team, a platoon, or USACIDC special agents.
- **Supervise the collection effort.** The collectors must be provided with reporting guidelines. How often should they report? Should they report "no information?" Specific reporting instructions should be provided, including how, when, and where they report. A collection tasking chart should also be used (Figure E-2). As more and more collectors are being used, it becomes important to track their missions, capabilities, and success. A brief note on the reporting instructions of each collector should be included.

PIAP Missions	Unit Tasked	Echelon Employed	POC	Collection Strategy Employed	Date Collection Started	Location	Date Collection Ended
PCIR 1							
PCIR 2							
PCIR 3							
PCIR 4							

Figure E-2. Collection Tasking Chart

PROCESS POLICE/CRIMINAL RAW DATA

E-7 This processing step converts raw data into police intelligence through analysis. The key to processing the data is to understand it. For example, as collectors report raw data it may often appear to be meaningless information. Rarely will one collector receive all of the necessary information to answer the PCIR at one time. Instead, a variety of information must be fitted together to form a coherent, even if incomplete, picture.

E-8 Every piece of data is important. This is the cardinal rule of the entire process. Until the data is analyzed for reliability and compared with other data, all reports must be treated equally. This is important to remember, for the trend will be to use data that either fits your expectations or gives the most complete picture.

E-9 A report of "no activity" can be as important as reports with information. If the collector is capable of collecting the information and is actively trying to collect, reports of "no activity" can be critical. First, if there is no indication of a change, they can be used to reprioritize PIAP missions. Second, they can be used to retask the collectors to other areas. It is important to check the mission's original intent periodically to ensure that it is still valid and merits further efforts.

E-10 To determine the reliability of the data, the MP leader must evaluate the source. Does the information come from the police chief, local youth, or other military forces? One of the best ways to determine the reliability of the information is to have more than one collector reporting on the same PCIR. If more than one collector reports the same information, it can normally be presumed to be accurate.

E-11 Information can be analyzed in a variety of ways—chronologically, geographically, by the impact on the force, by the type of activity or the modus operandi, or by the association of participants. The MP leader must evaluate the information after it is analyzed to determine whether the information collected answers the PCIR or whether it helps accomplish the PIAP mission. If the information does not answer these questions, he must decide whether it is necessary to task other collectors, retask the same collectors, or wait until the situation develops.

REPORT AND/OR DISSEMINATE POLICE AND CRIMINAL ASSESSMENT

E-12 *Reporting and disseminating is the most important aspect of the PIAP.* Collection and analysis is valueless unless the data is communicated to commanders who can best use the information.

E-13 Reporting requirements must be established based on the unit's SOP and other established processes. MP leaders must decide if the information collected must be sent using an established priority format or if it can wait to be sent using SITREPs. Does the information collected affect the force-protection measures or does it immediately impact the tactical scenario? Do we need to alert units operating in the vicinity of AA Fox to avoid sector 2? Additionally, MP leaders must ensure that any information released follows existing constraints and regulations.

E-14 It is also advantageous to provide feedback to the collectors. Collectors often receive no feedback on their performance. Informing them as to which part of their information was vital and beneficial can often increase their productivity in future operations.

SAMPLE SCENARIO

E-15 The following example helps illustrate the implementation of all six steps of the PIAP.

E-16 While deployed in support of Operation Control Chaos, US forces assigned to TF Blue Thunder are tasked with stability and support operations in the city of Corbina. This city, although currently implementing a peace treaty, was the site of extreme civil unrest. Even though the overall situation is not as chaotic as it was before US intervention, there are some sectors that

are still in turmoil. Common crimes (such as robberies, assaults, looting, and vandalism) still occur daily and there is fear that this condition may spread out of control throughout the city. The TF commander knows that in order to bring peace to the entire city, he must attempt to stabilize the situation in some of these bad sectors. He decides that the best way to deal with this situation is to assign a sector (sector 51) to an MP battalion in an attempt to control the situation. If the MP battalion succeeds, he may use the same concept throughout the city. He is aware of the five MP functions and how they can help bring this sector under some control. Under this framework, the TF commander issues the following mission: *On order, the MP battalion will conduct stability and support operations in the vicinity of sector 51, the city of Corbina, in support of TF Blue Thunder.* Upon receipt of this mission, the battalion commander gathered his staff and initiated the planning process. Before the MP staff could initiate the PIAP, they made contact with the S2/G2 and received an updated IPB estimate. Now that the IPB estimates are on-hand, the staff initiates the PIAP.

DETERMINE THE SCOPE OF THE PIAP

E-17 The staff performs the following steps to determine the scope of the PIAP:

- **Conduct a mission analysis.** The staff looks at the given mission, the higher echelon commander's intent, and the concept of operations. After considering all of these factors, they produce a restated mission—*On order, the battalion will conduct MP operations in sector 51 to determine the type of threat and to bring this sector under control in support of TF Blue Thunder.*
- **Prioritize PIAP missions.** Since there is only one mission, this subtask is not applicable.
- **Determine the AO and the AOI.** The staff determines that the AO is the entire sector 51 and that the AOIs are the sectors adjacent to 51.
- **Determine key terrain.** The staff determines that the key terrains are the market place, the plaza, and the city park. They select these areas because most of the incidents occurred in these populated areas. Stabilization in these key areas may be advantageous to mission success.
- **Determine required information products/sources.** The end result is the stabilization of sector 51. Minimize the crime incidents and restore L&O. Information should come from the local police chief, local community leaders, civil affairs, PSYOP, and the CID.

ASSEMBLE WORKING AIDS

E-18 The staff assembles the following working aids in support of the PIAP:

- **Maps.** The staff acquires local maps that detail the market place, the plaza, and the city park. Although the maps are in a foreign language, the staff is able to identify these three prominent features and surrounding areas.
- **Language aids.** In addition to dictionaries, the staff is able to get two translators from civil affairs.

- **Open-source information.** Open-source information includes a variety of encyclopedias and country books. Newspaper reports and historical crime data is available via the internet or through MI sources. The emphasis is in obtaining information on the history and composition of the local police force.
- **Classified intelligence.** The staff receives a briefing from the S2/G2 describing the operations of SOF units in the area.
- **Other working aids.** Computers, charts, templates, and acetate are available.

DETERMINE INFORMATION REQUIREMENTS AND COORDINATE ACCESS TO DATA

E-19 After a careful analysis of all available information, the following information gaps were turned into PCIR:

- Why is the police force not actively engaged in L&O?
- What is the major threat to civilians in each area?
- Are local gangs involved?
- Is their local judicial system in place?
- Where are prisoners housed?

E-20 The staff consults with the USACIDC, MI, other MP units, and other sources but determines that the information provided is not clear or sufficient. Since the PCIR are not resolved, the staff decides to recommend that the commander initiate a collection effort.

RECOMMEND AND SUPERVISE THE POLICE/CRIMINAL COLLECTION EFFORT

E-21 The staff performs the following steps to recommend and supervise the police/criminal collection effort:

- **Develop a collection strategy.** Upon coordinating with the S2/G2, the SJA, and the CID, the MP commander decides that the best collectors will come from within organic assets. He decides that he will employ the MP to go out and seek the needed information. The battalion commander will employ a company commander to interview the local police chief and an MP/interpreter will patrol around the designated AOI. The MP commander will need additional interpreters to help him with his collection effort.
- **Task or request specific collectors.** The MP staff requests an interpreter through the normal chain of command. The TF G3 assigns six interpreters for a period of 90 days.
- **Supervise the collection effort.** All collectors are instructed to report not later than (NLT) 1800 every day. The report will be in the form of an 'end of day' outbrief to the S2 and the battalion commander. A collection tasking chart (Figure E-3) will also be completed.

PROCESS POLICE/CRIMINAL RAW DATA

E-22 After receiving all of the above information, the S2 concludes that the inability of the police force to do their job has had a domino effect on all areas.

of peace and order. This information is confirmed through other reports from information collected by the CID (through their own efforts) and the CA. The information also reveals that the gangs have intentions of attacking US forces if they interfere with their "business." The S2 determines that although the situation may seem to be chaotic, once the locals are able to trust the police forces, everything should return to normal.

REPORT AND/OR DISSEMINATE POLICE AND CRIMINAL ASSESSMENT

E-23 Since the collection effort identifies a potential threat to US forces, the commander decides to notify higher headquarters and increase his own force-protection measures. He requires MP elements patrolling in designated areas to be no less than a squad. If patrolling dismounted, a HMMWV or an ASV will trail the squad. The MP commander uses the information provided during the PIAP to develop his implementation plan. This plan includes joint patrols, training, and construction of a joint MP/local national police station.

PIAP Mission: Bring Sector 51 Under Control								
PCIR	Unit Tasked	Echelon Employed	POC	Collection Strategy Employed	Date Collection Started	Location	Date Collection Ended	PCIR Result
Why is the police force not actively engaged in IL&O operations?	A Co	2 teams	CPT Smith	Direct interview	31 Jan 00	Sector 51, Police HQ	2 Feb 00	The police force does not know how to interact with the population.
What is the major threat to civilians in each area?	A Co	6 teams	1LT Thomas	Patrol and interview	31 Jan 00	Market place, plaza, and park	7 Feb 00	Muggings, robberies, and stabbings are the major threats to civilians.
Are local gangs involved?	A Co	2 teams	CPT Smith	Direct interview	31 Jan 00	Sector 51, Police HQ	2 Feb 00	Two rival gangs exist.
Is a local judicial system in place?	A Co	2 teams	1LT Jones	Direct interview	31 Jan 00	Courthouse	3 Feb 00	A judicial system exists, but the judge is afraid to sentence anyone.
Where are the prisoners housed?	A Co	4 teams	1LT Lucas	AS and MMS	31 Jan 00	Local prison	2 Feb 00	The local prison is abandoned.

Figure E-3 Sample Collection Tasking Chart

Glossary

ILT	first lieutenant
A/L	administrative and logistics
AA	assembly area
AATF	air-assault task force
ABCS	Army Battle Command Systems
ACE	analysis and control element
ACIRS	Automated Criminal Investigative Reporting System
ACT	analysis control team
ADA	air-defense artillery
ADC	area damage control
AFATDS	Advanced Field-Artillery Tactical Data System
ALO	authorized level of organization
AMDPCS	Air- and Missile-Defense Planning and Control System
AO	area of operation
AOE	Army of Excellence
AOI	area of interest
AOR	area of responsibility
APOD	aerial port of debarkation
APOE	aerial port of embarkation

AR	armored
AR	Army regulation
ARFOR	Army forces
AS	area security
ASAS	All-Source Analysis System
ASCC	Army service component command
ASG	area support group
ASP	ammunition supply point
ASR	alternate supply route
ASV	armored security vehicle
ATCCS	Army Tactical Command and Control System
attn	attention
AWIS	Army WMCCS Information System
BCT	brigade combat team
bde	brigade
BFA	battlefield functional area
BLD	brigade liaison detachment
bn	battalion
BOS	battlefield operating system
BRT	brigade reconnaissance troop
BWA	battlefield workload analysis

C²	command and control
C³	command, control, and communications
C4I	command, control, communications, computers, and intelligence
C4IFTW	<i>command, control, communications, computers, and intelligence for the warrior</i>
CAS	close air support
CASE	corps-area support element
CCIU	computer-crime investigative unit
cdr	commander
CG	commanding general
CHA	corps holding area
CI	civilian internee
CID	Criminal Investigation Division
CIDR	Criminal Investigation Division Regulation
CINC	commander in chief
CIP	Criminal Intelligence Program
cmd	command
CMOC	civil-military operations center
co	company
COA	course of action
CofS	Chief of Staff
commo	communications

COMMZ	communications zone
conf	confinement
CONUS	continental US
COSCOM	corps support command
CP	command post
CPT	captain
CRC	Crime Records Center
CRIMINTEL	criminal intelligence
CRS-3	Correctional Reporting System
CS	combat support
CSA	corps storage area
CSE	corps support element
CSG	corps support group
CSM	command sergeant major
CSS	combat service support
CSSCS	Combat Service Support Control System
cust	customs
CZ	combat zone
DA	Department of the Army
DC	District of Columbia
DCCP	division central collection point

DCG	deputy commanding general
DIBRS	Defense Incident-Based Reporting System
DISCOM	division support command
div	division
DLEA	domestic law-enforcement agency
DMMC	division materiel management center
DNA	deoxyribonucleic acid
DOD	Department of Defense
DOJ	Department of Justice
DOS	Department of State
DPM	deputy provost marshal
DRA	division rear area
DS	direct support
DSA	division support area
DSB	division support battalion
DSE	division support element
DSS	decisive shaping, and sustaining
DZ	drop zone
EAC	echelons above corps
EAD	echelons above division
ECB	echelons corps and below

EG	escort guard
EMS	emergency medical services
EPW	enemy prisoner of war
ERP	engineer regulation point
ES	escort
FA	field artillery
FBCB2	Force XXI Battle Command—Brigade and Below
FBI	Federal Bureau of Investigation
Feb	February
FEBA	forward edge of the battle area
FIU	field investigative unit
FM	field manual
FOB	forward operating base
FOIA	Freedom of Information Act
FORSCOM	US Army Forces Command
FSB	forward-support battalion
FSC	forward-support company
G1	Assistant Chief of Staff, G1 (Personnel)
G2	Assistant Chief of Staff, G2 (Intelligence)
G3	Assistant Chief of Staff, G3 (Operations and Plans)
G4	Assistant Chief of Staff, G4 (Logistics)

- G5** Assistant Chief of Staff, G5 (Civil Affairs)
- G6** Assistant Chief of Staff, G6 (Communications)
- GAC** ground-assault convoy
- GCCS** Global Command and Control System
- GCCS-A** Global Command and Control System—Army
- GD** guard
- GO** government organization
- GS** general support
- HHB** headquarters and headquarters battery
- HHC** headquarters and headquarters company
- HHD** headquarters and headquarters detachment
- HMMWV** high-mobility multipurpose, wheeled vehicle
- HN** host nation
- HQ** headquarters
- HRP** high-risk personnel
- HVA** high-value asset
- I/R** internment and resettlement
- IBCT** initial/interim brigade combat team
- IC** information center
- IEW** intelligence and electronic warfare
- IG** inspector general

IHO	international humanitarian organization
IMETP	International Military Education and Training Program
IO	international organization
IPB	intelligence preparation of the battlefield
IRIC	internment/resettlement information center
ISB	intermediate staging base
ITO	installation transportation officer
J3	Operations Directorate
Jan	January
JFC	joint-force command
JOA	joint-operations area
JP	joint publication
JRA	joint rear area
JSOA	joint special operations area
JTF	joint task force
km	kilometer(s)
L&O	law and order
LID	light infantry division
liq	liquid
LOC	lines of communication
LOGSEC	logistics security

LRP	long-range plan
LSTA	logistics-security threat assessment
LVOSS	Light-Vehicle Obscuration Smoke System
LZ	landing zone
M/O	marksman/observer
M/S	mobility/survivability
MACOM	major Army command
MAJ	major
MCRP	Marine Corps reference publication
MCS	Maneuver Control System
MDMP	military decision-making process
mech	mechanized
MEDEVAC	medical evacuation
METL	mission-essential task list
METT-TC	mission, enemy, terrain, troops, time available, and civilian considerations
MEVA	mission-essential or vulnerable area
MFPU	major fraud procurement unit
MI	military intelligence
MILCOM	military community
min	minimum
MKT	mobile kitchen trailer

MLRS	Multiple-Launch Rocket System
MMS	maneuver and mobility support
MOB	main operating base
MOOTW	military operations other than war
MP	military police
MPBTF	military police brigade task force
MPMIS	Military Police Management Information System
MQS	military qualification standards
MSR	main supply route
MTOE	modified table of organization and equipment
MTP	mission training plan
MTT	mobile training team
MWD	military working dog
NATO	North Atlantic Treaty Organization
naut	nautical
NBC	nuclear, biological, and chemical
NCO	noncommissioned officer
NEO	noncombatant evacuation operation
NG	national guard
NGO	nongovernmental organization
NIBRS	National Incident-Based Reporting System

NLT	not later than
NLT	nonlethal weapon
NWP	Naval warfare publication
OCONUS	outside the continental US
OPCON	operational control
OPLAN	operation plan
opns	operations
OPSEC	operations security
ORS-2W	Offense Reporting Systems Windows
PASE	port-area support element
PCIR	police/criminal information requirements
PDF	Panamanian Defense Force
PEO	peace-enforcement operation
PI	police intelligence
PIAP	police information assessment process
PIO	police intelligence operations
PIR	priority intelligence requirements
PKO	peacekeeping operation
plt	platoon
PM	provost marshal
POC	point of contact

POD	port of debarkation
POE	port of embarkation
POL	petroleum, oil, and lubricants
PRC	populace and resource control
PSD	protective security detail
PSU	protective-service unit
PSVA	personal-security vulnerability assessment
PSYOP	psychological operations
pub	publication
PWIS-3	Prisoner-of-War Information System
PZ	pickup zone
R&S	reconnaissance and surveillance
RAOC	rear-area operations center
RC	reserve component
ROC	rear operations center
ROE	rules of engagement
rqmt	requirement
RSOI	reception, staging, onward movement, and integration
RSTA	reconnaissance, surveillance, and target acquisition
RWS	remote workstation
S1	Adjutant (US Army)

- S2** Intelligence Officer (US Army)
- S3** Operations and Training Officer (US Army)
- S4** Supply Officer (US Army)
- S5** Civil-Affairs Officer (US Army)
- S6** Communications Officer (US Army)
- SALUTE** size, activity, location, unit, time, and equipment
- SAW** squad automatic weapon
- SCI** sensitive compartmented information
- sec** section
- SEP** separate
- SFC** sergeant first class
- SITREP** situation report
- SJA** staff judge advocate
- SMS** Security Management System
- SOC** security-operations cell
- SOF** special-operations forces
- SOFA** status of forces agreement
- SOI** signal operating instructions
- SOP** standing operating procedures
- SPOD** seaport of debarkation
- SPOE** seaport of embarkation

SPOTREP	spot report
spt	support
sq	square
sqd	squad
SRT	special-reaction team
STAMIS	Standard Army Management Information System
stat	statute
STCCS	Strategic Theater Command and Control System
TA	theater Army
TAA	tactical assembly area
TAACOM	Theater Army Area Command
TAC	tactical
TACCIMS	Theater Automated Command and Control Information Management System
TAI	traffic accident investigation
TASE	TSC-area support element
TC-AIMS	Transportation Coordinator Automated Movement Server
TCF	tactical combat force
TCP	traffic-control post
TF	task force
THREATCON	threat condition
TM	technical manual

TMO	traffic-management officer
tms	teams
TO	theater of operations
TOE	tables of organization and equipment
TRADOC	US Army Training and Doctrine Command
TRP	traffic-regulation plan
TSA	theater storage area
TSC	theater support command
TSE	tactical support element
TTP	tactics, techniques, and procedures
UMT	unit ministry team
UN	United Nations
US	United States
USACIDC	US Army Criminal Investigation Command
USACIL	US Army Criminal Investigations Laboratory
USAF	US Air Force
USAMPS	US Army Military Police School
USC	US Code
USCG	United States Coast Guard
USCS	US Customs Service
USDA	US Department of Agriculture

VIP very important person

VRS Vehicle Registration System

WMCCS Worldwide Military Command and Control System

Bibliography

- AR 15-6. *Procedures for Investigating Officers and Boards of Officers* 11 May 1988
- AR 190-12 *Military Police Working Dogs* 30 September 1993
- AR 190-45 *Law Enforcement Reporting* 30 September 1988
- AR 190-47 *The Army Corrections System* 15 August 1996.
- AR 195-2 *Criminal Investigation Activities* 30 October 1985
- AR 525-13 *Antiterrorism/Force Protection (AT/FP) Security of Personnel, Information, and Critical Resources* 10 September 1998
- CIDR 195-1 *Special Agent Operations Manual* October 1994
- DA Form 2028 *Recommended Changes to Publications and Blank Forms*
1 February 1974
- FM 3-0 *Operations* To be published within the next 6 months
- FM 19-1 *Military Police Support for the AirLand Battle* 23 May 1988
- FM 19-4 *Military Police Battlefield Circulation Control, Area Security, and Enemy Prisoner of War Operations* 7 May 1993
- FM 19-10 *The Military Police Law and Order Operations* 30 September 1987
- FM 19-40 *Enemy Prisoners of War Civilian Internees and Detained Persons*
27 February 1976
- FM 34-2 *Collection Management and Synchronization Planning* 8 March 1994
- FM 34-130 *Intelligence Preparation of the Battlefield* 8 July 1994
- FM 41-10 *Civil Affairs Operations* 14 February 2000
- FM 63-4 *Combat Service Support Operations—Theater Army Area Command*
24 September 1984
- FM 71-3 *The Armored and Mechanized Infantry Brigade* 8 January 1996
- FM 71-100 *Division Operations* 28 August 1996
- FM 90-13-1 *Combined Arms Breaching Operations* 28 February 1991
- FM 90-40 *Multiservice Procedures for the Tactical Employment of Nonlethal Weapons (NLW) (MCRP 3-15 8 NWP 3-07-31, USCG Pub 3-07 31)* 6 October 1998
- FM 100-1 *The Army* 14 June 1994

FM 100-5 *Operations* 14 June 1993

FM 100-8 *The Army in Multinational Operations* 24 November 1997

FM 100-10 *Combat Service Support* 3 October 1995

FM 100-15 *Corps Operations* 29 October 1996

FM 100-17-3 *Reception, Staging, Onward Movement, and Integration* 17 March 1999

FM 101-5 *Staff Organization and Operations* 31 May 1997

FM 101-5-1 *Operational Terms and Graphics (MCRP 5-2A)* 30 September 1997

JP 3-10 *Joint Doctrine for Rear Area Operations* 28 May 1996

USC Title 18 *Crimes and Criminal Procedure* 23 January 2000

USC Title 32 *National Guard* 5 January 1999

Index

A

AATF *See* air-assault task force (AATF)
ADC *See* area damage control (ADC)
air-assault division, 7-7
air-assault task force (AATF), 7-7
air-base defense, 4-7
airborne division, 7-6
alternate supply route (ASR), 4-2, 4-5
ammunition supply point (ASP), 4-7
antiterrorism, 12-3
AOE *See* Army of Excellence (AOE)
AOR *See* area of responsibility (AOR)
area damage control (ADC), 4-6
area of responsibility (AOR), 1-3
area security (AS), 1-1, 3-3, 3-8, 4-3, 4-6—4-9, 5-2, 7-7, 10-1
area support group (ASG), 3-7
Army information systems, D-1
Army of Excellence (AOE), 7-5, 7-6, 7-8, 7-10, 9-5
Army service component command (ASCC), 1-4, 1-5, 1-6, 5-1, 5-5
AS *See* area security (AS)
ASCC *See* Army service component command (ASCC)
ASG *See* area support group (ASG)
ASP *See* ammunition supply point (ASP)
ASR *See* alternate supply route (ASR)
asymmetric threat, 3-5
augmentation, 7-4, 7-5, 8-1, 8-2, 8-4, 11-6
automated systems, D-5

B

band, 7-3
base cluster, 3-7, 4-7

base defense, 4-7
battle command, 1-2, 2-1
battlefield,
 circulation and control, 1-1
 effects, 4-14
 environment, 4-14
 missions, 1-2
 organization, 1-4—1-7
 visualization, 2-1—2-2
battlefield workload analysis (BWA), 1-7, C-1
BCT *See* brigade combat team (BCT)
breaching operations, 4-2, 4-3, 7-4
brigade combat team (BCT), 7-7
BWA *See* battlefield workload analysis (BWA)

C

C² *See* command and control (C²)
capabilities 1-2
CCIU *See* computer-crime investigative unit (CCIU)
centralized MACOM, 9-2
CI *See* civilian internee (CI)
CID *See* Criminal Investigation Division (CID)
CIP *See* Criminal Intelligence Program (CIP)
civil affairs, 4-5, 4-13
civil disturbances, 3-3, 4-11
civil-military operations center (CMOC), 1-8, 4-13
civilian internee (CI), 1-7, 1-8, 4-9, 4-10, 5-4, 5-5
CMOC *See* civil-military operations center (CMOC)
COA *See* course of action (COA)
collection point, 4-4, 6-5, 7-5
collection strategy, E-4
combat zone (CZ) 1-4, 1-7, 4-4
combating terrorism, 11-8—11-9
Combating Terrorism Program, 4-13
command and control (C²), 2-2, 7-2 9-2
commander's intent, 2-2

communications zone (COMMZ), 1-4, 1-5, 3-6, 4-4, 5-2
COMMZ *See* communications zone (COMMZ)
computer-crime investigative unit (CCIU), 9-6
concept of operations, 2-2
confinement, 4-10
contiguous, 1-4, 3-7
control element, 6-3
convoy security, 4-8
corps rear area, 3-6
corps support command (COSCOM), 5-2, 6-4
corps support group (CSG), 3-7
COSCOM *See* corps support command (COSCOM)
counterdrug operations, 11-7
countering the threat, 3-7
course of action (COA), 2-3, 4-14
CRC *See* Crime Records Center (CRC)
Crime Records Center (CRC), 9-7—9-8
crime threat analysis, 4-13
criminal activities, 3-3
criminal intelligence (CRIMINTEL), 9-1, 9-2, 9-3, D-6
Criminal Intelligence Program (CIP), 4-13
criminal investigation, 4-11—4-12, 9-2
Criminal Investigation Division (CID), 1-6, 3-6
CRIMINTEL *See* criminal intelligence (CRIMINTEL)
CSG *See* corps support group (CSG)
customs team, 1-5, 1-7, 4-11, 5-2
CZ *See* combat zone (CZ)

D

defeat, 4-6
defense plans, 3-7
delay, 4-6
detainees, 11-17
digitization, 7-11
direct support (DS), 2-3

disaster,
 man-made, 1-2
 natural, 1-2
 relief, 11-4—11-6
 DISCOM *See* division support
 command (DISCOM)
 dislocated civilian, 1-7, 1-8, 4-4,
 4-5, 6-5, 11-17
 distributed, 7-8
 diversionary attacks, 3-6
 division MP company, 7-2—7-3
 division rear area (DRA), 3-6
 division support area (DSA), 7-5
 division support command
 (DISCOM), 5-2, 7-2
 Division XXI, 7-1, 7-8—7-11
 divisional brigade, 8-2
 doctrinal publications, B-1
 doctrine, B-1
 DRA *See* division rear area
 (DRA)
 DS *See* direct support (DS)
 DSA *See* division support area
 (DSA)

E

EAC *See* echelons above corps
 (EAC)
 echelons above corps (EAC), 5-1
 effective coordination, 11-5
 enemy-controlled agents, 3-3
 enemy priority target, 3-5
 enemy prisoner of war (EPW), 1-1,
 1-7, 1-8, 4-9, 4-10, 5-4, 5-5,
 7-11
 enemy sympathizers, 3-3
 EPW *See* enemy prisoner of war
 (EPW)
 escort-guard company, 1-7, 5-6
 espionage, 3-3

F

FBCB2 *See* Force XXI battle
 command—brigade and
 below (FBCB2)
 FEBA *See* forward edge of the
 battle area (FEBA)
 field investigative unit (FIU), 9-6
 FIU *See* field investigative unit
 (FIU)
 FOB *See* forward operating base
 (FOB)
 force-projection doctrine, 1-2
 force-protection, 1-2, 3-3, 4-11,
 7-11, 12-1
 Force XXI, 1-3, 9-5

Force XXI battle command—
 brigade and below (FBCB2),
 7-10
 forced-entry operations, 7-1
 forensic laboratory, 9-7
 forward edge of the battle area
 (FEBA), 3-5
 forward operating base (FOB), 7-6,
 7-7
 forward support battalion (FSB),
 7-10
 forward support company (FSC),
 7-10
 FSB *See* forward support battalion
 (FSB)
 FSC *See* forward support
 company (FSC)
 functional-area considerations, 8-3

G

general support (GS), 2-3
 Geneva convention, 5-5
 GO *See* government organization
 (GO)
 government organization (GO), 1-8
 GS *See* general support (GS)
 guard company, 1-7
 guerrilla forces, 3-3

H

heavy division, 7-4—7-5
 high-risk personnel (HRP), 4-6,
 4-8, 12-2
 high-value asset (HVA), 3-5, 3-6,
 7-10
 holding area, 4-2, 6-4
 HRP *See* high-risk personnel
 (HRP)
 humanitarian assistance, 11-4—
 11-6
 HVA *See* high-value asset (HVA)

I

I/R *See* internment and
 resettlement (I/R)
 IBCT *See* initial/internm brigade
 combat team (IBCT)
 IHO *See* international
 humanitarian organization
 (IHO)
 initial-entry force, 8-1
 initial/internm brigade combat team
 (IBCT), 1-7, 8-1, 8-2—8-5
 integrated, 7-8
 intelligence preparation of the
 battlefield (IPB), 2-3, 4-13,
 4-14, 6-3, E-1

interagency operations, 1-7
 intermediate staging base (ISB),
 7-6
 international humanitarian
 organization (IHO), 1-8
 international organization (IO), 1-8
 internment and resettlement (I/R),
 1-2, 4-9—4-10, 10-1
 investigative team, 9-5
 IO *See* international organization
 (IO)
 IPB *See* intelligence preparation
 of the battlefield (IPB)
 ISB *See* intermediate staging
 base (ISB)

L

L&O *See* law and order (L&O)
 language aids, E-3
 law and order (L&O), 1-1, 1-5,
 4-10—4-12
 law enforcement, 4-11, 12-2—
 12-3, E-4
 LID *See* light infantry division
 (LID)
 light infantry division (LID), 7-5—
 7-6
 lines of communications (LOC),
 1-4, 4-2, 5-2, 6-4
 LOC *See* lines of communication
 (LOC)
 logistics security (LOGSEC), 4-12,
 7-1, 9-1, 9-2
 logistics security threat
 assessment, 4-13
 LOGSEC *See* logistics security
 (LOGSEC)
 long-range plans (LRP), 6-2
 LRP *See* long-range plans (LRP)

M

M/O *See* marksman/observer
 (M/O)
 main supply route (MSR), 4-2, 4-3,
 4-5, 5-3
 maneuver and mobility support
 (MMS), 1-2, 3-8, 4-2—4-6,
 4-11, 5-2, 7-7, 10-1
 marksman/observer (M/O), 4-11
 MDMP *See* military decision-
 making process (MDMP)
 METL *See* mission-essential task
 list (METL)
 METT-TC *See* mission, enemy,
 terrain, troops, time available,
 and civilian considerations
 (METT-TC)

MEVA *See* mission-essential or vulnerable area (MEVA)
 MI *See* military intelligence (MI)
 military decision-making process (MDMP), 7-10
 military intelligence (MI), 3-6, E-4
 military operations other than war (MOOTW), 3-3, 9-4, 9-6
 military police
 automated systems, D-4
 availability, 3-9
 battalion (CS), 11-15
 battalion (I/R), 5-6—5-8
 brigade, 11-13
 brigade (CS), 5-2—5-4, 6-1—6-2
 brigade (I/R), 5-4—5-6
 company, 11-15
 dispersion, 3-9
 functions, 1-2, 4-1
 I/R units, 11-16—11-17
 Military Police Management Information System (MPMIS), D-5
 military prisoners, 4-10, 5-4
 military working dog (MWD), 4-5, 4-7, 4-11, 4-12, 5-2, 5-3, 6-2
 mission analysis, E-2
 mission, enemy, terrain, troops, time available, and civilian considerations (METT-TC), 1-5, 1-7, 1-8, 2-3, 4-3, 5-2, 5-3, 6-4, 7-2, 9-5
 mission-essential or vulnerable area (MEVA), 12-2
 mission-essential task list (METL), 8-3
 MMS *See* maneuver and mobility support (MMS)
 modified table of organization and equipment (MTOE), 1-5
 MOOTW *See* military operations other than war (MOOTW)
 MPMIS *See* Military Police Management Information System (MPMIS)
 MSR *See* main supply route (MSR)
 MTOE *See* modified table of organization and equipment (MTOE)
 multidimensional, 7-8
 multifunctional capabilities, 1-8
 multinational operations, 1-7
 MWD *See* military working dog (MWD)

N

NBC *See* nuclear, biological, and chemical (NBC)
 NEO *See* noncombatant evacuation operation (NEO)
 neutrality, 11-5
 NGO *See* nongovernmental organization (NGO)
 NLW *See* nonlethal weapon (NLW)
 noncombatant evacuation operation (NEO), 11-9
 noncontiguous, 1-4, 3-7
 nongovernmental organization (NGO), 1-6, 1-8
 nonlethal weapon (NLW), 11-13
 nonlinear, 7-8
 nuclear, biological, and chemical (NBC), 3-4, 4-4

O

objectivity, 11-5
 OPCON *See* operational control (OPCON)
 open-source information, E-3
 operational control (OPCON), 2-2, 4-2, 5-2
 operational framework, 1-3—1-4
 operational unity, 11-5
 operations,
 combat, 1-7, 2-3, 4-2, 6-3
 combat service support (CSS), 1-7, 2-3, 4-2, 6-3
 combat support (CS), 1-7, 2-3, 4-2, 6-3
 confinement, 5-7—5-8
 decisive, shaping, and sustaining (DSS), 1-4
 defensive, 10-1, 10-3
 offensive, 10-1—10-2
 protective service, 9-3
 rear area, 3-1—3-2, 3-7, 4-7, 4-8
 reconnaissance, 3-6, 4-6—4-7
 resettlement, 5-7
 river crossing, 4-2
 security, 5-2
 security-assistance, 11-9—11-11
 stability, 1-2, 8-4, 11-1, 11-3, 11-15
 support, 1-2, 8-4, 11-1, 11-3, 11-15
 sustainment, 3-1—3-2, 3-7, 4-7, 4-8
 operations security (OPSEC), 1-8, E-3

OPSEC *See* operations security (OPSEC)

P

passage of lines, 4-2, 4-3—4-4
 PCIR *See* police/criminal information requirements (PCIR)
 peacekeeping operation (PKO), 11-11—11-13
 peacetime engagement operations, 3-1
 personal-security vulnerability assessment (PSVA), 4-13
 physical security, 3-3, 12-1—12-2
 PIAP. *See* police information assessment process (PIAP)
 PIO *See* police intelligence operations (PIO)
 PIR *See* priority intelligence requirements (PIR)
 PKO *See* peacekeeping operation (PKO)
 planning element, 6-3
 POD *See* port of debarkation (POD)
 POE *See* port of embarkation (POE)
 police/criminal information requirements (PCIR), 4-17
 police information assessment process (PIAP), 2-3, 4-15, 4-17, 6-3, E-1
 police intelligence operations (PIO), 1-2, 3-8, 4-13—4-18
 active mode, 4-17
 passive mode, 4-15
 populace and resource control (PRC), 4-10
 port of debarkation (POD), 5-6
 port of embarkation (POE), 5-6
 positive image, 11-5
 Posse Comitatus Act, 11-3
 PRC *See* populace and resource control (PRC)
 precise, 7-8
 priority intelligence requirements (PIR), 4-17
 protective-service unit (PSU), 9-6
 provost marshal (PM) cell, 2-3
 PSU *See* protective-service unit (PSU)
 PSVA *See* personal-security vulnerability assessment (PSVA)
 psychological operations (PSYOP), 4-13, 4-17

PSYOP *See* psychological operations (PSYOP)
public acceptance, 11-5

R

R&S *See* reconnaissance and surveillance (R&S)
raid, 4-11
RAOC *See* rear-area operations center (RAOC)
rear area, 3-1
rear-area operations center (RAOC), 5-3, 5-1, 6-5
rear-area security, 4-7
reception, staging, onward movement, and integration (RSOI), 3-2—3-3
reconnaissance, 4-2, 4-5
 area, 4-6
 zone, 4-6
reconnaissance and surveillance (R&S), 4-5, 7-11, 10-3
reconnaissance, surveillance, and target acquisition (RSTA), 8-3
refugees, 1-8, 6-5
replacement unit, 4-4
response force, 3-7—3-8, 4-6, 4-8
river-crossing operations, 4-2, 7-4
ROE *See* rules of engagement (ROE)
RSOI *See* reception, staging, onward movement, and integration (RSOI)
RSTA *See* reconnaissance, surveillance, and target acquisition (RSTA)
rules of engagement (ROE), 11-1, 11-9

S

sabotage, 3-3
security, 4-8
security force, 4-7
separate brigades, 8-1—8-2
simultaneous, 7-8
situational awareness, 2-1, 3-6
small tactical units, 3-4
special-reaction team (SRT), 4-11
SRT *See* special-reaction team (SRT)
staff relationships, 2-3
Stafford Act, 11-3
staging area, 4-2
straggler control, 4-4, 6-5
subversion, 3-3
support functions, 3-1
support relationships, 2-3

T

TAA *See* tactical assembly area (TAA)
tables of organization and equipment (TOE), 7-2, 7-3
tactical assembly area (TAA), 7-7
tactical combat force (TCF), 3-8
tactics, techniques, and procedures (TTP), B-1—B-2
TCF *See* tactical combat force (TCF)
TCP *See* traffic control post (TCP)
terrorism, 3-3, 12-3
theater of war, 1-4, 1-5
theater support command (TSC), 1-4, 1-5, 1-6, 5-1
threat,
 awareness, 11-5
 level, 3-3—3-4
 location, 3-5—3-7
 priorities, 3-4—3-5
threat-level matrix, 3-4
TOE *See* tables of organization and equipment (TOE)
traffic-control post (TCP), 4-2, 4-3, 4-5
traffic-regulation plan (TRP), 4-5
TRP *See* traffic-regulation plan (TRP)
TSC *See* theater support command (TSC)
TTP *See* tactics, techniques, and procedures (TTP)

U

unconventional forces, 3-4
United States Army Criminal Investigation Command (USACIDC), 4-12, 9-1, E-4
 agents 11-7
 organization, 9-4—9-6
 wartime support, 9-2—9-4
United States Army Criminal Investigations Laboratory (USACIL), 9-7
United States Customs Service (USCS), 4-12
USACIDC *See* United States Army Criminal Investigation Command (USACIDC)
USACIL *See* United States Army Criminal Investigations Laboratory (USACIL)
USCS *See* United States Customs Service (USCS)
use of force, 11-5

FM 3-19.1 (FM 19-1)
22 MARCH 2001

By Order of the Secretary of the Army:

ERIC K. SHINSEKI
General, United States Army
Chief of Staff

Official



JOEL B HUDSON
Administrative Assistant to the
Secretary of the Army
0103705

DISTRIBUTION:

Active Army, Army National Guard, and US Army Reserve To be distributed in accordance with the initial distribution number 111046, requirements for FM 3-19.1

PIN: 078884-000

800TH MILITARY POLICE BRIGADE RULES OF ENGAGEMENT FOR OPERATIONS IN IRAQ

NOTHING IN THESE RULES LIMITS YOUR INHERENT AUTHORITY AND OBLIGATION TO TAKE ALL NECESSARY AND APPROPRIATE ACTION TO DEFEND YOURSELF, YOUR UNIT, AND OTHER US FORCES.

1. **HOSTILE FORCES** Until a there has been a declared cessation of hostilities Iraqi military and paramilitary forces are considered hostile, and may be attacked provided there is positive identification of a legitimate military target, and the target has not surrendered or is otherwise out of battle due to sickness or wounds Do not target, except in self defense, civilians, protected sites (i.e., hospitals, places of worship, schools, cultural institutions), or civilian infrastructure If you must fire on these objects engage to disable or disrupt rather than destroy, if possible

2 **HOSTILE ACTORS** Any other person attacking or threatening US or Coalition Forces will be considered to be a hostile actor You may engage persons who commit hostile acts or show hostile intent with the force necessary to counter the hostile act or demonstrated hostile intent and to protect US Forces

Hostile act An attack or other use of force against US Forces or a use of force that directly precludes/impedes the mission/duties of US Forces

Hostile intent The threat of imminent use of force against US Forces or the threat of force to preclude/impede the mission/duties of US Forces

- 3 You may use force, up to and including deadly force, against hostile actors:
- a In self-defense,
 - b In defense of your unit, or other US Forces,
 - c To prevent the theft, damage, or destruction of firearms, ammunition, explosives, or property designated by your Commander as vital to national security (Protect other property with less than deadly force.)

RULES FOR DETAINEE OPERATIONS

SOLDIERS MUST BE POSTURED TO RESPOND IMMEDIATELY WITH LETHAL FORCE TO ANY THREAT DEATH OR SERIOUS BODILY HARM. SOLDIERS CONDUCTING DETENTION OPERATIONS WILL NOT BE SENT INTO ANY POTENTIALLY LETHAL OPERATION POSTURED PRIMARILY FOR NONLETHAL FORCE.

4 **ESCALATION OF FORCE** IF US OR COALITION FORCES OR INNOCENT CIVILIANS ARE BEING ATTACKED OR REASONABLY PERCEIVED TO BE IN DANGER YOU ARE AUTHORIZED TO RESPOND WITH DEADLY FORCE WITHOUT FIRST EMPLOYING LESSER FORMS OF FORCE. Any persons demonstrating hostile intent or committing a hostile act may be engaged using necessary and proportional force, up to and including **DEADLY FORCE**. When possible, use the following degrees of force against hostile actors

- a SHOUT, verbal warnings to HALT or "KIFF" (pronounced "COUGH")
- b SHOVE, physically restrain, block access, or detain
- c SHOW, your weapon and demonstrate intent to use it
- d SHOOT, to remove the threat of death/serious bodily injury or to protect designated property **IF YOU MUST FIRE**

(1) Fire only aimed shots **NO WARNING SHOTS**

- (2) Fire no more rounds than necessary.
- (3) Fire with due regard for the safety of innocent bystanders
- (4) Take reasonable efforts not to destroy property
- (5) Stop firing as soon as the situation permits

5 RIOTS/PROTECTING DESIGNATED PERSONNEL: Detention Facility Commanders may authorize non-lethal munitions. However, the soldier or soldiers conducting the mission must retain the capability to immediately revert to lethal force if the situation dictates. The decision cycle should always be to respond to a potential lethal situation postured to use lethal force, assess the situation, and if the situation dictates, to transition to non-lethal force.

6 ESCAPES. If a detainee attempts to escape the guard must shout HALT (KIFF) three (3) times. If the attempt to escape is from a fenced-in enclosure, the detainee will be fired on once the person has actually cleared the outside compound wire and is continuing their efforts to escape, unless that would endanger other guards or innocent civilians.

7 Treat all persons with dignity and respect.

THE ABOVE ROE IS IN EFFECT AS OF 30 NOVEMBER 2003 AND SUPERCEDES ALL PRIOR 800TH MP BDE ROE

INTERROGATION RULES OF ENGAGEMENT

Approved approaches for

All detainees:

Direct
Incentive
Incentive Removal
Emotional Love / Hate
Fear Up Harsh
Fear Up Mild
Reduced Fear
Pride & Ego Up
Futility
We Know All
Establish Your Identity
Repetition
File & Dossier
Rapid Fire
Silence

Require CG's Approval:

Change of scenery down
Dietary Manip (monitored by med)
Environmental Manipulation
Sleep Adjustment (reverse sched)
Isolation for longer than 30 days
Presence of Mill Working Dogs
Sleep Management (72 hrs max)
Sensory Deprivation (72 hrs max)
Stress Positions (no longer than 45 min)

Safeguards:

- ~ Techniques must be annotated in questioning strategy
- ~ Approaches must always be humane and lawful
- ~ Detainees will NEVER be touched in a malicious or unwanted manner
- ~ Wounded or medically burdened detainees must be medically cleared prior to interrogation
- ~ The Geneva Conventions apply within CJTF-7

**EVERYONE IS RESPONSIBLE FOR ENSURING COMPLIANCE TO THE IROE.
VIOLATIONS MUST BE REPORTED IMMEDIATELY TO THE OIC.**

The use of the techniques are subjects to the general safeguards as provided as well as specific guidelines implemented by the 205th MI Cdr FM 34-52, and the Commanding General, CJTF 7

RULES OF ENGAGEMENT Deadly force may be used in self-defense Always use the minimum force necessary to maintain discipline and compliance with detention facility rules Warning shots are not authorized

a Escalation of force IF US OR COALITION FORCES OR INNOCENT CIVILIANS ARE BEING ATTACKED OR REASONABLY PERCEIVED TO BE IN DANGER YOU ARE AUTHORIZED TO RESPOND WITH DEADLY FORCE WITHOUT FIRST EMPLOYING LESSER FORMS OF FORCE Any persons demonstrating hostile intent or committing a hostile act may be engaged using necessary and proportional force, up to and including DEADLY FORCE When possible, use the following degrees of force against hostile actors

- 1 SHOUT, verbal warnings to HALT or "KIFF" (pronounced "COUGH")
- 2 SHOVE, physically restrain, block access, or detain
- 3 SHOW, your weapon and demonstrate intent to use it
- 4 SHOOT, to remove the threat of death/serious bodily injury or to protect designated property IF YOU MUST FIRE
- 5 Fire only aimed shots, NO WARNING SHOTS
- 6 Fire no more rounds than necessary
- 7 Fire with due regard for the safety of innocent bystanders
- 8 Take reasonable efforts not to destroy property
- 9 Stop firing as soon as the situation permits

b Riots (protecting designated personnel) Detention Facility Commanders may authorize non-lethal munitions However, the soldier or soldiers conducting the mission must retain the capability to immediately revert to lethal force if the situation dictates The decision cycle should always be to respond to a potential lethal situation postured to use lethal force, assess the situation, and if the situation dictates, to transition to non-lethal force

c Escapes If a detainee attempts to escape the guard must shout HALT (KIFF three (3) times If the attempt to escape is from a fenced-in enclosure, the detainee will be fired on once the person has actually cleared the outside compound wire and is continuing their efforts to escape, unless that would endanger other guards or innocent civilians

10 RULES OF INTERACTION (ROI) The BCCF's policy on soldiers ROI with Prisoners/Detainees are the following Under no circumstance will any deviation from these rules be tolerated Any violations must be reported immediately to the BN TOC

- a Treat all detainees with respect
- b Respect religious articles and materials

- c Treat all medical problems seriously
- d Do not engage in casual conversations
- e Do not discuss politics or conflicts
- f Do not make promises
- g Do not make obscene gestures
- h Do not make derogatory remarks or political comments about detainees and their cause
- i Do not engage in commerce or trade
- j Do not show favoritism
- k Do not exchange gifts with detainees

~~SECRET//NOFORN//SI~~

HEADQUARTERS
COMBINED JOINT TASK FORCE SEVEN
BAGHDAD IRAQ
APO AE 09335

REPLY TO
ATTENTION OF

12 OCT 2003

CJTF-7 CG

MEMORANDUM FOR

C2 Combined Joint Task Force Seven Baghdad, Iraq 09335
C3 Combined Joint Task Force Seven Baghdad Iraq 09335
Commander 205th Military Intelligence Brigade Baghdad Iraq 09335

SUBJECT CJTF-7 Interrogation and Counter-Resistance Policy

1 ~~(S//NF)~~ This memorandum establishes the interrogation and counter-resistance policy for security internees under the control of CJTF-7. Security internees are civilians who are detained pursuant to Articles 5 and 78 of the Geneva Convention Relative to the Protection of Civilian Persons in Time of War of August 12, 1949 (hereinafter Geneva Convention).

2 ~~(S//NF)~~ I approve the use of specified interrogation and counter-resistance approaches A as described in Enclosure 1 relating to security internees subject to the following:

a ~~(S//NF)~~ Use of these approaches is limited to interrogations of security internees under the control of CJTF-7.

b ~~(S//NF)~~ These approaches must be used in combination with the safeguards described in Enclosure 2.

c ~~(S//NF)~~ Segregation of security internees will be required in many instances to ensure the success of interrogations and to prevent the sharing of interrogation methods among internees. Segregation may also be necessary to protect sources from other detainees or otherwise provide for their security. Additionally, the Geneva Convention provides that security internees under definite suspicion of activity hostile to the security of Coalition forces shall, where absolute military necessity requires, be regarded as having forfeited rights of communication. Accordingly, these security internees may be segregated. I must approve segregation in all cases where such segregation will exceed 30 days in duration, whether consecutive or nonconsecutive. Submit written requests with supporting rationale to me through the CJTF-7 C2. A legal review from the CJTF-7 SJA must accompany each request.

d ~~(S//NF)~~ In employing each of the authorized approaches, the interrogator must maintain control of the interrogation. The interrogator should appear to be the one who controls all aspects of the interrogation, to include the lighting, heating and configuration of the interrogation room, as well as the food, clothing and shelter given to the security internee.

~~SECRET//NOFORN//SI~~

DECLASSIFIED

BY U.S. Central Command

DATE 15 OCT 2004

ANNEX 94

CJTF 7-CG

SUBJECT CJTF-7 Interrogation and Counter-Resistance Policy

3 ~~(S//NF)~~ Requests for use of approaches not listed in Enclosure 1 will be submitted to me through CJTF 7 C2 and will include a description of the proposed approach and recommended safeguards. A legal review from the CJTF-7 SJA will accompany each request.

4 ~~(S//NF)~~ Nothing in this policy limits existing authority for maintenance of good order and discipline among persons under Coalition control.

5 ~~(S//NF)~~ This policy supersedes the CJTF-7 Interrogation and Counter-Resistance Policy signed on 14 September 2003.

6 ~~(S//NF)~~ POC is MAJ [REDACTED] DNVT [REDACTED] DSN [REDACTED]

2 Encls

- 1 Interrogation Approaches (SI)
- 2 General Safeguards

RICARIDO S. SANCHEZ
Lieutenant General, USA
Commanding

CF Commander, US Central Command

INTERROGATION APPROACHES (Security Internees)

~~(S//NF)~~ Use of the following approaches is subject to the application of the general safeguards provided in enclosure (2). Specific implementation guidance with respect to approaches A-Q is provided in U.S. Army Field Manual 34-52. Brigade Commanders may provide additional implementation guidance.

A ~~(S//NF)~~ Direct: Asking straightforward questions. The most effective of all approaches. It is the most simple and efficient approach to utilize.

B ~~(S//NF)~~ Incentive/Removal of Incentive: Providing a reward or removing a privilege above and beyond those required by the Geneva Convention. Possible incentives may include favorite food items, changes in environmental quality, or other traditional or regional comforts not required by the Geneva Convention.

C ~~(S//NF)~~ Emotional Love: Playing on the love a security internee has for an individual or group. May involve an incentive, such as allowing communication with the individual or group.

D ~~(S//NF)~~ Emotional Hate: Playing on the genuine hatred or desire for revenge a security internee has for an individual or group.

E ~~(S//NF)~~ Fear Up Harsh: Significantly increasing the fear level in a security internee.

F ~~(S//NF)~~ Fear Up Mild: Moderately increasing the fear level in a security internee.

G ~~(S//NF)~~ Reduced Fear: Reducing the fear level in a security internee or calming him by convincing him that he will be properly and humanely treated.

H ~~(S//NF)~~ Pride and Ego Up: Flattering or boosting the ego of a security internee.

I ~~(S//NF)~~ Pride and Ego Down: Attacking or insulting the pride or ego of a security internee.

J ~~(S//NF)~~ Futility: Invoking the feeling in a security internee that it is useless to resist by playing on the doubts that already exist in his mind.

K ~~(S//NF)~~ We Know All: Convincing the security internee that the interrogator already knows the answers to questions being asked.

L ~~(S//NF)~~ Establish Your Identity: Convincing the security internee that the interrogator has mistaken the security internee for someone else. The security internee is encouraged to "clear his name."

M ~~(S//NF)~~ Repetition: Continuously repeating the same question to the security internee during an interrogation to encourage full and candid answers to questions.

N ~~(S//NF)~~ File and Dossier: Convincing security internee that the interrogator has a voluminous, damning and inaccurate file which must be corrected by the security internee.

Enclosure 1

Q ~~(S//NF)~~ Mutl and Jeff Arr interrogation team consisting of a friendly and a harsh interrogator. This approach is designed to cause the security internee to have a feeling of hostility toward one interrogator and a feeling of gratitude toward the other.

P ~~(S//NF)~~ Rapid Fire Questioning in rapid succession without allowing security internee to answer questions fully.

Q ~~(S//NF)~~ Silence. Stating at the security internee to encourage discomfort.

GENERAL SAFEGUARDS

~~(S//NF)~~ Application of these interrogation approaches is subject to the following general safeguards:

(i) limited to use by trained interrogation personnel. (ii) there is a reasonable basis to believe that the security internee possesses information of intelligence value. (iii) the security internee is medically evaluated as a suitable candidate for interrogation (considering all approaches to be used in combination). (iv) interrogators are specifically trained for the approaches. (v) a specific interrogation plan, including reasonable safeguards, limits on duration, intervals between applications, termination criteria and the presence or availability of qualified medical personnel has been developed. and (vi) there is appropriate supervision.

(U) The purpose of all interviews and interrogations is to get the most information from a security internee with the least intrusive method applied in a humane and lawful manner with sufficient oversight by trained investigators or interrogators. Interrogators and supervisory personnel will ensure uniform, careful, and safe conduct of interrogations.

~~(S//NF)~~ Interrogations must always be planned, deliberate actions that take into account factors such as a security internee's current and past performance in both detention and interrogation, a security internee's emotional and physical strengths and weaknesses, assessment of approaches and individual techniques that may be effective, strengths and weaknesses of interrogators, and factors which may necessitate the augmentation of personnel.

~~(S//NF)~~ Interrogation approaches are designed to manipulate the security internee's emotions and weaknesses to gain his willing cooperation. Interrogation operations are never conducted in a vacuum; they are conducted in close cooperation with the detaining units. Detention regulations and policies established by detaining units should be harmonized to ensure consistency with the interrogation policies of the intelligence collection unit. Such consistency will help to maximize the credibility of the interrogation team and the effectiveness of the interrogation. Strict adherence to such regulations, policies and standard operating procedures is essential.

~~(S//NF)~~ Interrogators must appear to completely control the interrogation environment. It is important that interrogators be provided reasonable latitude to vary approaches depending on the security internee's cultural background, strengths, weaknesses, environment, extent of resistance training, as well as the urgency with which information believed in the possession of the security internee must be obtained.

~~(S//NF)~~ Interrogators must ensure the safety of security internees, and approaches must in no way endanger them. Interrogators will ensure that security internees are allowed adequate sleep and that diets provide adequate food and water and cause no adverse medical or cultural effects. Where segregation is necessary, security internees must be monitored for adverse medical or psychological reactions. Should military working dogs be present during interrogations, they will be muzzled and under control of a handler at all times to ensure safety.

~~(S//NF)~~ While approaches are considered individually within this analysis, it must be understood that in practice approaches are usually used in combination. The title of a particular approach is not always fully descriptive of a particular approach. The cumulative effect of all approaches to be

employed must be considered before any decision is made regarding approval of a particular interrogation plan .

-

156 L&O DET (DS TO 1MNB-N)

94 MP CC (DS TO 82ABN)
855 MP CO (DS TO 82ABN)

USMC TOA WITH 82D ABN

152 L/O DET

DS TO 13 COSCOM

1 (U) SITUATION.

1 A (U) ENEMY FORCES [NO CHANGE]

1.B (U) FRIENDLY FORCES [CHANGE]

1 B 1. ~~(S//REL/MCFI)~~ MILITARY POLICE UNITS FOR OIF 2 ARE SOURCED AT 50% OF WHAT OIF 1 MP UNITS WERE SOURCED. PRIORITY OF MILITARY POLICE SUPPORT IS DETAINEE OPERATIONS, JOINT POLICE OPERATIONS, AND MANEUVER AND MOBILITY SUPPORT OPERATIONS. CG, CJTF-7 DIRECTS ALL ECHELONS ABOVE DIVISION (EAD) MILITARY POLICE UNITS TO A GENERAL SUPPORT (GS) ROLE IOT SUPPORT CJTF-7 MISSION PRIORITIES.

2 (U) MISSION [NO CHANGE]

3 (U) EXECUTION

3 A COMMANDER'S INTENT [CHANGE] MILITARY POLICE BRIGADE HEADQUARTERS WILL COORDINATE AND SYNCHRONIZE PLANNING AND EXECUTION IOT FACILITATE A SMOOTH TRANSITION ACROSS CJTF-7 AO.

3.B. ~~(S//REL/MCFI)~~ CONCEPT OF OPERATIONS [CHANGE] AS CITE-1 MP BRIGADES' TRANSITION FROM A THREE BRIGADE SET (18 MP BDE, 220 MP BDE, 800 MP BDE) TO A TWO BRIGADE SET (89 MP BDE, 16 MP BDE (ABN)), ~~ON 1 FEB 04, MP TASK ORGANIZATION CHANGE.~~ THE TASK ORGANIZATION DEPICTS THE SET FOR OIF II AND 89th MP BDE IS TACON TO 1 AD AND 16th MP BDE (ABN) IN GENERAL SUPPORT TO CJTF-7. OIF I UNITS IN DIRECT SUPPORT REMAIN DS UNTIL REDEPLOYMET. MILITARY POLICE AND MP ILO UNITS WILL SUPPORT PRIORITY MISSIONS DETERMINED BY COMMANDER, CJTF-7. CURRENT PRIORITIES ARE DETAINEE OPERATIONS WITH FOCUS ON HIGH VALUE DETAINEES, MEK, SECURITY DETAINEES, AND IRAQI JAIL AND PRISON MONITORING, JOINT POLICE OPERATIONS WITH FOCUS ON TRAINING, MONITORING, AND JOINT INTEL BASED OPERATIONS; AND MANEUVER MOBILITY SUPPORT OPERATIONS ON MSR TAMPA FROM SCANIA TO LSA ANACONDA. 89th MP BRIGADE ASSUMES RESPONSIBILITY FOR US MILITARY POLICE OPERATIONS IN AO BAGHDAD TO INCLUDE THE HVD DETENTION FACILITY AND OF THE MEK COMPOUND IN AO NORTH CENTRAL. 16th MP BRIGADE (ABN) ASSUMES RESPONSIBILITY FOR US MILITARY POLICE OPERATIONS IN AO WEST, MND-CS, AND MND-SE. 16th MP BRIGADE (ABN) IS RESPONSIBLE FOR MMSO ON MSR TAMPA FROM CS' NAVISTAR TO LSA ANACONDA, WITH PRIORITY OF SUPPORT FROM CSC SCANIA TO LSA ANACONDA. UPON TOA WITH THE 82ND ABN, I MEF WILL PROVIDE ORGANIC ASSETS AND ASSUME RESPONSIBILITY FOR MILITARY POLICE OPERATIONS

IN AO WEST, WITH THE EXCEPTION OF THE OPERATION OF BCCF, WHICH WILL REMAIN THE RESPONSIBILITY OF THE 16TH MP BRIGADE (ABN). 89 MP IS TACON TO 1 CAV UPON TOA WITH 1 AD AND 1 CAV AND EACH MSC RECEIVES DS MP IAW THE TASK ORGANIZATION.

3 C TASKS TO SUBORDINATE UNITS

3.C.1 (U) **89 MP BDE**

3 C 1.A UPON TOA ON 1 FEB 04 ACCEPT ATTACHMENT OF ALL EAD MP UNITS IN AO BAGHDAD.

3 C 1 B ASSUME RESPONSIBILITY OF MEK DETENTION OPERATIONS IN AO NORTH-CENTRAL.

3 C 1.C ASSUME RESPONSIBILITY OF HVD DETENTION OPERATIONS IN AO BAGHDAD

3 C 1.D MONITOR IRAQI CORRECTIONS SERVICE (ICS) OPERATIONS AT THE BAGHDAD JAILS MONITOR ICS OPERATIONS ICW CPA MOJ CORRECTION ADVISORS.

3 C 1 E MONITOR IRAQI POLICE OPERATIONS IN AO BAGHDAD ICW CPA MOI POLICE ADVISORS.

3 C 1 F. CONTINUE TO TRAIN IPS AT DIRECTED CJTF7 POLICE ACADEMIES AND TIP TRAINING LOCATIONS IAW IPS ACCELERATION PLAN.

3 C 1.G PROVIDE AN MP COMPANY HEADQUARTERS AND 2 PLATOONS ISO THE IRAQI SECURITY GROUP (ISG) IN AO BAGHDAD.

3.C 1.H PROVIDE MP SUPPORT TO CPA WITH THE 170TH MP CO (-) AND ASSIST WITH PSD AUGMENTATION TO AMB BREMER'S SECURITY DETAIL AND CONTINUE TO SUPPORT FOR OIF II WITH A COMPANY HEADQUARTERS AND THREE PLATOONS.

3.C 1.I. PROVIDE MP SECURITY SUPPORT TO STB AT CAMP VICTORY WITH THE 59TH MP CO RELIEF FROM THIS MISSION OCCURS UPON THE REDEPLOYMENT OF 59TH MP CO O/A 23 MARCH 04 WHEN 82D ABN DRB ASSUMES SUPPORT OF THIS MISSION IAW FRAGO 18 PARA 3 C 6 B

3 C.2 (U) **16 MP BDE (ABN)**

3 C 3.A UPON TOA ON 1 FEB 04 ACCEPT ATTACHMENT OF ALL EAD US MP UNITS IN MNC-CS AND MND-SE, AND MP UNITS CONDUCTING MMSO MISSIONS IN AO BAGHDAD AND AO NORTH-CENTRAL

3 C 3 B UPON TOA BETWEEN 82ABN AND IMEF, IMEF ASSUMES RESPONSIBILITY FOR AO WEST WITH EXCEPTION OF PARAGRAPH 3.C.3 D.

3 C 3 C CONDUCT MMSO ON MSR TAMPA WITH PRIORITY OF SUPPORT FROM CSC SCANIA TO LSA ANACONDA

3.C 3 D ASSUME RESPONSIBILITY FOR OPERATION OF BCCF IN AO WEST AND CAMP BUCCA IN MND-SE.

3 C 3 E MONITOR IRAQI POLICE OPERATIONS WITH PRIORITY OF EFFORT TO CJTF-7 DESIGNATED TARGET CITIES. MONITOR IPS OPERATIONS ICW CPA MOI POLICE ADVISORS

3 C 3.F. CONTINUE TO TRAIN IPS AT DIRECTED CJTF-7 POLICE ACADEMIES AND TIP TRAINING LOCATIONS IAW IPS ACCELERATION PLAN

3 C 3 G MONITOR ICS OPERATIONS ICW CPA MOJ CORRECTION ADVISORS

3 D (J) COORDINATING INSTRUCTIONS

3.D.1. (U) RELIEFS IN PLACE WILL BE PLANNED AND EXECUTED UNDER THIS TASK ORGANIZATION WITH LEFT SEAT RIDES BEGINNING NLT 25 JAN 04.

3.D 2. (U) DILAUTH BETWEEN MSC'S AND MP BRIGADES IS AUTHORIZED AND DIRECTED

3 C 3 (U) MSC'S ARE RESPONSIBLE TO PROVIDE THEIR OWN MSR SECURITY

3 D.4 (U) CID WILL CONTINUE WITH NO CHANGES TO TASK ORGANIZATION OR OPERATIONAL SET

3 D 5 (U) COORDINATION FOR STAY BEHIND EQUIPMENT IAW DA AND CJTF7 FRAGOS, AND ICW UP-ARMORED VEHICLE REALIGNMENT WILL BE COORDINATED DIRECTLY BETWEEN MP BRIGADES WITH CONFLICTS OR ISSUES SUBMITTED TO CJTF-7 PMO AND C4 NLT 15 FEB 04

3.D.6 (U) DILAUTH AUTHORIZED TO ENSURE SMOOTH TRANSITION WITH CPA MOJ ADVISORS AS THEY INCREASE THEIR RESPONSIBILITY FOR MONITORING WITH THE TRANSITION TO IRAQI CONTROL.

4 (U) SERVICE SUPPORT [CHANGE]

4 A (U) 16TH AND 89TH MP BRIGADES ARE RESPONSIBLE FOR MAINTAINING A RSOI CELL THROUGHOUT THE OPERATION

5 (U) COMMAND AND SIGNAL. [CHANGE]

5.A (U) THE POC FOR THIS FRAGO IS MAJ MIGLIARA AT DSN. 318-558-0710 OR MICHAEL.MIGLIARA@C5MAIN HQ C5 ARMY.SMIL MIL

5 A 1 (U) THE POC FOR THE 89TH MP BDE IS MAJ RINDAL AT DNVT 302-559-4530 OR JOEL RINDAL@C5MAIN HQ C5.ARMY SMIL MIL

5 A 2 (U) THE POC FOR 18TH MP BDE IS MAJ BOICE AT DNVT. 302-559-5130 OR GILLIAN BOICE@C5MAIN.HQ C5 ARMY SMIL.MIL

5 A.3. (U) THE POC FOR THE 16TH MP BDE (ABN) IS MAJ BOBBY ATWELL AT DNVT 302-550-8220 OR BOBBY.ATWELL@C5MAIN HQ C5.ARMY SMIL.MIL

5 A.4 U) THE POC FOR THE 220TH MP BDE IS MAJ WADE AT DNVT: 302-550-8220 OR POBIN WADE@C5MAIN.HQ.C5 ARMY SMIL.MIL

5 A.5 U) THE POC FOR 800TH MP BDE IS MAJ CAVALLARO AT DNVT: 302-559-7143 OR ANTHONY CAVALLARO@C5MAIN.HQ C5.ARMY.SMIL.MIL

ACKNOWLEDGE

SANCHEZ
LTG

OFFICIAL:

MILLER
C3
ATTACHMENTS

* UNCLASSIFIED *

OTAUZYUW RUEADWD6648 0092209-UUUU--RUERPHB RUEASRB RUEASRG.
ZNR UUUUU
O 092140Z JAN 03
FM DA WASHINGTON DC//DAMO-ODM//
TO RUEASRB/CDRFORSCOM FT MCPHERSON GA//AFOP-PL/AFOP-OCM/AFOP-PLM/
AFOP-OC//
RUERSOC/CDRUSASOC FT BRAGG NC//AOP-OPM/AOP-OP/AOP-PO-MOB//
RUEAHC/CDRJSARPAC FT SHAFTER HI//APOP/APOP-OP/APOP-PL-M//
RHMFIUU/CDRJSARPAC FT SHAFTER HI//APOP/APOP-OP/APOP-PL-M//
RUERGAB/CDR FT BENNING GA//ATZB-AG/ATSH-OTP-M/ATGB-AGX//
RHMFIUU/CDR FT BENNING GA//ATZB-AG/ATSH-OTP-M/ATGB-AGX//
RUEASLA/CDRARPERSCOM ST LOUIS MO//ARPC-MOP-P//
RUEASRB/CDRUSARC FT MCPHERSON GA//AFRC-OPO/AFRC-DCG//
RUEAHOF/CDRARPERSCOM ALEXANDRIA VA//TAPC-MOB//
RHMFIUU/CDRARPERSCOM ALEXANDRIA VA//TAPC-MOB//
RUCBACM/USCINCFJCOM NORFOLK VA//J1/J33//
RUFGCIN/USCINCEUR VAHINGEN GE//J1/J3/ECRA//
RUEKJCS/JCINT STAFF WASHINGTON DC//J4-SMED/J1/J3(JOD)/J4(LRC)//
RUEADFA/CDR FT MCCOY WI//AFRC-FM-BSR-R//
RUERSHA/CDRUSAFIVE AND FT SAM HOUSTON TX//AFKB-OP/AFKB-PA/AFKB-
LG/AFKB-OP-M/AFKB-OP-GT-TR/AFKB-GT/AFKB-EOC//
RUEASRG/CDRUSAONE FT GILLEM GA//AFKA-OP-OPM/AFKA-PP/AFKA-PA/
AFK-LG/AFKA-EOC//
RUFNTU/CDR USAMEDDAC HEIDELBERG GE//AEAGC/AEAGC-O/AEAGC-P(MOB)
//
RHMFIUU/CDR USAMEDDAC HEIDELBERG GE//AEAGC/AEAGC-O/AEAGC-P(MOB)
//
RUEADWD/DA WASHINGTON DC//DAMO-ODM/DAMO-ZXG/DAPE-PRO-PCC/SALL/S
APA-PP/SAFM-BUC-E/SAMR/DAAR-OP/DAPE-PCC/DAAR-OFD/
DAAR-PE-M/DAMO-ZR/MOSO-SOD/DAMO-AOC-CAT/DASG-HCZ/
DAMO-ODK//
RUERAIX/CDRTRADOC FT MONROE VA//ATTG-P/ATCD/ATCS-EOC//
RUFDAU/CDRUSAREUR HEIDELBERG GE//AEAGC/AEAGC-O/AEAGC-P(MOB)//
RUEARNG/ARNGRC ARLINGTON VA//NGB-ARO-D/NGB-ARO//
RHMFIUU/ARNGRC ARLINGTON VA//NGB-ARO-D/NGB-ARO//
RUERNUB/CDR FT BLISS TX
RUEAMTC/CDRMTMC ALEXANDRIA VA
RHMFIUU/CDRMTMC ALEXANDRIA VA
RUEABSE/DOC FT DIX NJ
RHMFIUU/DOC FT DIX NJ
RUEABSB/CMD GP FT DIX NJ
RHMFIUU/CMD GP FT DIX NJ
RHCUAAA/AMC SCOTT AFB IL
RUDIDFE/DFAS INDIANAPOLIS IN//EOC//
RHMFIUU/DFAS INDIANAPOLIS IN//EOC//
AIG 12521
INFO RUERSHA/CDRUSAMEDCOM FT SAM HOUSTON TX//MCOP-P/MCOP-O//
RHMFIUU/CDRUSAMEDCOM FT SAM HOUSTON TX//MCOP-P/MCOP-O//
RUCQSAA/COMSOPAC HONOLULU HI//SOJ1//
RUCQSOC/USCINCSOC MACDILL AFB FL//J1//
RHMFIUU/USCINCSOC MACDILL AFB FL//J1//
RUCOBBA/COMSOPJFCOM//J1//
RUEAHC/USARPAC DCSOPS FT SHAFTER HI//APOP-PL-M/APCG//

RHMFIIU/USARPAC DCSOPS FT SHAFTER HI//APOP-PL-M/APCG//
RUFGAID/USCINCEUR INTEL VAIHINGEN GE
RUERNUK/CDRUSAA FT KNOX KY
RUERNUK/CDRUSAAA FTB KNOX KY
RUERKOA/CDRUSAARMC FT KNOX KY
RHMFIIU/CDRUSAARMC FT KNOX KY
RUEOEGA/CDRARCENTEODKU KUWAIT KU
RUERFDA/CDR FT DRUM NY
RUEAPHT/CDRUSAG FT CAMPBELL KY
RHMFIIU/CDRUSAG FT CAMPBELL KY
RUEACQC/CDR FT CARSON CO
RHMFIIU/CDR FT CARSON CO
RUERLEX/CDR FT LEE VA
RUEAWIS/CDR FT LEWIS WA
RUEANBA/CDR FT BELVOIR VA
RUEABUC/CDRUSARSO FT BUCHANAN PR
RHMFIIU/CDRUSARSO FT BUCHANAN PR
RUERSHA/MEDCOM HQ EOC FT SAM HOUSTON TX
RUEADWD/DA WASHINGTON DC//DAMO-AOC-CAT//
RUCUFFA/TAG AIR KS TOPEKA KS
RUEARSL/TAG AK ANCHORAGE AK
RUEARSL/TAG AK FT RICHARDSON AK
RHMFIIU/TAG AK FT RICHARDSON AK
RUERMTA/TAG AL MONTGOMERY AL
RHMFIIU/TAG AL MONTGOMERY AL
RHCPROC/TAG AR LITTLE ROCK AFB AR
RUEAARZ/TAG AZ PHOENIX AZ
RHMFIIU/TAG AZ PHOENIX AZ
RUEASMB/TAG CA SACRAMENTO CA
RHMFIIU/TAG CA SACRAMENTO CA
RUEAEDN/TAG CO DENVER CO
RUERNHC/TAG CT HARTFORD CT
RUEANDG/TAG DE WILMINGTON DE
RHMFIIU/TAG DE WILMINGTON DE
RUEADWD/TAG EAST
RUEAFLA/TAG FL ST AUGUSTINE FL
RHMFIIU/TAG FL ST AUGUSTINE FL
RUNGCAZ/TAG GU AGANA GU
RUEAHIC/TAG HI HONOLULU HI
RHMFIIU/TAG HI HONOLULU HI
RUERDJA/TAG IA JOHNSTON IA
RUHUBBA/TAG ID BOISE ID
RUEAILA/TAG IL SPRINGFIELD IL
RHMFIIU/TAG IL SPRINGFIELD IL
RUEANIN/TAG IN INDIANAPOLIS IN
RUERTKS/TAG KS TOPEKA KS
RUERFRA/TAGKY FRANKFORT KY
RHMFIIU/TAGKY FRANKFORT KY
RUEAXLA/TAG LA NEW ORLEANS LA
RHMFIIU/TAG LA NEW ORLEANS LA
RUEACKA/TAG MA MILFORD MA
RHMFIIU/TAG MA MILFORD MA
RUEATBM/TAG MD BALTIMORE MD
RUEATAM/TAG ME AUGUSTA ME
RHMFIIU/TAG ME AUGUSTA ME
RUEALMM/TAG MI LANSING MI
RHMFIIU/TAG MI LANSING MI

RUEAXMO/TAG MO JEFFERSON CITY MO
RHMFIUU/TAG MO JEFFERSON CITY MO
RUERAGO/TAG MS JACKSON MS
RUEANMT/TAG MT HELENA MT
RHMFIUU/TAG MT HELENA MT
RUERRNA/TAG NC RALEIGH NC
RHMFIUU/TAG NC RALEIGH NC
RUEABID/TAG ND BISMARCK ND
RHMFIUU/TAG ND BISMARCK ND
RUCULIB/TAG NE LINCOLN NE
RHMFIUU/TAG NE LINCOLN NE
RUEANDE/TAG NH CONCORD NH
RHMFIUU/TAG NH CONCORD NH
RUEANJG/TAG NJ TRENTON NJ
RHMFIUU/TAG NJ TRENTON NJ
RUEAMFE/TAG NM SANTA FE NM
RHMFIUU/TAG NM SANTA FE NM
RUEACWV/TAG NV CARSON CITY NV
RUEATNY/TAG NY LATHAM NY
RUERCOH/TAG OH COLUMBUS OH
RHMFIUU/TAG OH COLUMBUS OH
RUEAXOK/TAG OK OKLAHOMA CITY OK
RHMFIUU/TAG OK OKLAHOMA CITY OK
RUEANOR/TAG OR SALEM OR
RUEAXIA/TAG PA ANNVILLE PA
RHMFIUU/TAG PA ANNVILLE PA
RUEABUC/TAG PR SAN JUAN PR
RUERNPR/TAG RI PROVIDENCE RI
RUERSCA/TAG SC COLUMBIA SC
RUEASDN/TAG SD RAPID CITY SD
RJVVRMA/TAG TN NASHVILLE TN
RHMFIUU/TAG TN NASHVILLE TN
RJEATXA/TAG TX CP MABRY TX
RHMFIUU/TAG TX CP MABRY TX
RUEANUT/TAG UT DRAPER UT
RULGPSJ/TAG VI ST CROIX VI
RUEOLIJ/TAG VT COLCHESTER VT
RHMFIUU/TAG VT COLCHESTER VT
RUHHFMA/TAG WA TACOMA WA
RUVOBMA/TAG WI MADISON WI
RUVABQG/TAG WV CHARLESTON WV
RUEAWYA/TAG WY CHEYENNE WY
RHMFIUU/TAG WY CHEYENNE WY
RUEABXL/65 RSC OPNS FT BUCHANAN PR
RHMFIUU/65 RSC OPNS FT BUCHANAN PR
RUEABSA/77 RSC OPNS FT TOTTEN NY
RHMFIUU/77 RSC OPNS FT TOTTEN NY
RUEABTB/81 RSC OPNS BIRMINGHAM AL
RHMFIUU/81 RSC OPNS BIRMINGHAM AL
RUEABSA/90 RSCOPNS LITTLE ROCK AR
RHMFIUU/90 RSCOPNS LITTLE ROCK AR
RUEABTQ/94 RSC OPNS DEVENS RFTA MA
RHMFIUU/94 FSC OPNS DEVENS RFTA MA
RUEABTZ/99 RSC OPNS OAKDALE PA
RHMFIUU/99 RSC OPNS OAKDALE PA
RUFMDMS/RSC EUROPE NAPLES IT

B"

UNCLAS

SUBJ:DA MOB ORDER 271-03 OPS NOBLE EAGLE/ENDURING FREEDOM

1 REFERENCES.

A. UNDER SECDEF MEMO 20 SEP 01, MOBILIZATION/DEMOBILIZATION PERSONNEL AND PAY POLICY FOR RESERVE COMPONENT MEMBERS ORDERED TO ACTIVE DUTY IN RESPONSE TO THE WORLD TRADE CENTER AND PENTAGON ATTACKS

B. SECDEF MSG 131954Z SEP 01, ATSD:PA/DPL, SUBJECT: PUBLIC AFFAIRS GUIDANCE (PAG) FOR PARTIAL MOBILIZATION OF THE RESERVE AND NATIONAL GUARD

C. DA MSG 172122Z DEC 01, SUBJECT: FINANCIAL MGT GUIDANCE #3 FOR OPS NOBLE EAGLE/ENDURING FREEDOM.

2. THE PRESIDENT, PURSUANT TO TITLE 10, USC, SECTION 12302 AND EXECUTIVE ORDER 13223 IN SUPPORT OF THE WORLD TRADE CENTER AND PENTAGON ATTACKS, AUTHORIZED THE MOBILIZATION OF UNITS AND INDIVIDUALS OF THE READY RESERVE.

3. THIS MESSAGE PROVIDES AUTHORIZATION TO ORDER THE RC UNIT(S) LISTED IN PARA 5 BELOW TO ACTIVE DUTY UNDER PARTIAL MOBILIZATION AUTHORITY (TITLE 10, USC 12302).

A. UNIT PERSONNEL ARE INVOLUNTARILY ORDERED TO ACTIVE DUTY IN THEIR CURRENT GRADES AND POSITIONS FOR AN INITIAL PERIOD OF UP TO 365 DAYS, ABSENT AUTHORIZED EXTENSIONS OR REORDERS TO ACTIVE DUTY, UNDER THE PROVISIONS OF DOD DIRECTIVE 1235.10 OR SUPPLEMENTAL GUIDANCE.

B. SPECIAL OPERATIONS FORCES (SOF) UNITS DEPLOYED AWAY FROM HOME STATION TO OCONUS THEATERS OF OPERATION WILL BE EMPLOYED NOT TO EXCEED 270 DAYS, EXCLUDING BRIEF TRANSITION PERIODS. UPON REDEPLOYMENT, SOLDIERS WILL DEMOBILIZE AND BE RELEASED FROM ACTIVE DUTY UNLESS EXCEPTION OR EXTENSION IS AUTHORIZED BY HQDA.

C. NON-SPECIAL OPERATIONS FORCES DEPLOYED AWAY FROM HOME STATION TO OCONUS THEATERS OF OPERATION WILL BE EMPLOYED NOT TO EXCEED 179 DAYS, EXCLUDING BRIEF TRANSITION PERIODS. UPON REDEPLOYMENT, SOLDIERS WILL DEMOBILIZE AND BE RELEASED FROM ACTIVE DUTY UNLESS EXCEPTION OR EXTENSION IS AUTHORIZED BY HQDA

D. UNLESS SPECIFICALLY STATED OTHERWISE THIS ORDER DOES NOT AUTHORIZE THE MOBILIZATION OF PROMOTABLE COLONELS OR GENERAL OFFICERS

4. MOBILIZATION STATIONS (MS) ARE SHOWN IN PARA 5. THE UNIT(S) WILL MOBILIZE AND MOVE TO ASSIGNED MS IAW TIME LINES ESTABLISHED IN THE FORSCOM MOBILIZATION AND DEPLOYMENT PLANNING SYSTEM (FORMDEPS) UNLESS OTHERWISE DIRECTED BY MACOM COMMANDER. UNIT STRENGTH WILL NOT EXCEED THE AUTHORIZED LEVEL STATED IN PARA 5

5. THE FOLLOWING UNIT(S) IS/ARE HEREBY ORDERED TO ACTIVE FEDERAL DUTY UNDER TITLE 10 USC, SECTION 12302.

A. EFFECTIVE MOBILIZATION DATE 16 JAN 03 AND MOBSAD 19 JAN 03:

UIC	DESCRIPTION	COMPO	PAX	HOME STA	MOB STATION
WRW3AA	417 CM DET SERVICE ORG		3	10	SHEFFIELD AL FT
STEWART GA					
WRW7AA	413 CM DET SERVICE ORG		3	10	DOBBINS GA FT
STEWART GA					
WQYAA	159 EN CO (ASLT BRG)		3	183	BRIDGEPORT WV FT
LEONARD WOOD MO					
WTBAAA	671 EN CO MULTI ROLE		3	184	PORTLAND OR FT
LEONARD WOOD MO					
WSJ5Y6	900 MP BDE (EPW) DET 6		3	43	UNIONDALE NY FT
DRUM NY					

B. EFFECTIVE MOBILIZATION DATE 23 JAN 03 AND MOBSAD 23 JAN 03.

UIC	DESCRIPTION	COMPO	PAX	HOME STA	MOB STATION
-----	-------------	-------	-----	----------	-------------

W75JY2 DET 2 3 BDE 95 DIVIT (MI) 3 6 FT SAM HOUSTON TX
FT HUACHUCA AZ

6 THE UNIT(S) LISTED IN PARAGRAPH 5 ABOVE WILL BE NOTIFIED OF THE MOBILIZATION EFFECTIVE DATE WITHIN 24 HOURS OF RELEASE OF THIS MESSAGE THE MOBILIZATION PERIOD MAY BE ADJUSTED DEPENDING ON MISSION REQUIREMENTS. COMMANDERS WILL INFORM SOLDIERS TO PLAN ACCORDINGLY

7 MACOMS WILL APPLY THE PROVISION OF AMOPES, FORMDEPS, AND AR 600-8-101 FOR PERSONNEL PROCESSING.

8 THIS ORDER IS THE DA MOVEMENT DIRECTIVE. PROVISIONS OF AR 55-113 AND AR 55-355 APPLY SUPPORT INSTALLATIONS ARE DIRECTED TO PROCESS REQUESTS FROM SUBJECT RC UNIT PENDING RECEIPT OF HARD COPY ORDERS TO ACTIVE DUTY.

9 MPA AND OMA ACCOUNTING CITATIONS FOR FY03 FOR CALL-UP OF RESERVE COMPONENT PERSONNEL TO SUPPORT OPERATIONS NOBLE EAGLE AND ENDURING FREEDOM ARE AS FOLLOWS:

A. MPA ACCOUNTING CITATIONS: UNITS MOBILIZED FOR ENDURING FREEDOM
21 3 20.0.0000 01-1100 P1W1C00 11**/12** VFRE F3203 5570 S99999
(OFFICER)

21 3 20.0.0000 01-1100 P2W2C00 11**/12** VFRE F3203 5570 S99999
(ENLISTED)

B. MPA ACCOUNTING CITATIONS: UNITS MOBILIZED FOR NOBLE EAGLE
21 3 20.0.0000 01-1100 P1W1A00 11**/12** VTER F9FP2 5570 S99999
(OFFICER)

21 3 20.0.0000 01-1100 P2W2A00 11**/12** VTER F9FP2 5570 S99999
(ENLISTED)

C. OMA FUND CITATIONS FOR MOBILIZED UNITS. ALL ARMY PERSONNEL, EXCEPT SOCOM ASSETS, ORDERED TO DEPLOY IN SUPPORT OF OPERATIONS NOBLE EAGLE AND/OR ENDURING FREEDOM WILL CONTACT THE RESPECTIVE RESOURCE MANAGEMENT OFFICE FOR FUND CITES.

(1) ALL UNITS, EXCEPT SOCOM UNITS, CONTACT THE SERVICING/INSTALLATION RESOURCE MANAGEMENT OFFICE AT THE DESIGNATED MOB STATION FOR TRAVEL AND TRANSPORTATION FUND CITES.

(2) SOCOM POC. MS BETTE OTTS DSN 239-4146 (COMM (910) 432-4146.

D TRAVEL ADVANCE ACCOUNTING CITATIONS MUST CITE A SPECIFIC FISCAL STATION NUMBER (FSN). RESERVE COMPONENT PERSONNEL WILL MOBILIZE AND DEMOBILIZE AT THE SAME STATION CITE THE FISCAL STATION NUMBER OF THE STATION WHERE MOBILIZATION/DEMOBILIZATION OCCURS (THE SAME STATION WHICH ISSUES THE ADVANCES). FOR ADDITIONAL GUIDANCE REFER DFAS-IN REG 37-1, ADVANCES AND PROGRESS PAYMENTS.

10 DEMOBILIZATION OF UNITS IS PROHIBITED WITHOUT PRIOR APPROVAL OF DA INDIVIDUAL MEMBERS OF THE UNIT WILL DEMOBILIZE WITH THE UNIT UNLESS PROVISIONS OF AR 600-8-24 OR AR 635-200 APPLY

11 PUBLIC AFFAIRS GUIDANCE SEE REF B, THIS MESSAGE, FOR SPECIFIC GUIDANCE

12 ALL SOLDIERS DEPLOYING INTO AFGHANISTAN AND PAKISTAN WILL POSSESS INTERCEPTOR BODY ARMOR (IBA). IN AN EFFORT TO IDENTIFY INTERCEPTOR BODY ARMOR (IBA) FIELDING REQUIREMENTS, ALL UNITS DEPLOYING TO AFGHANISTAN AND PAKISTAN ISO OPERATION ENDURING FREEDOM AND NOT PROCESSING THROUGH THE FORT BENNING CONUS REPLACEMENT CENTER (CRC) WILL NOTIFY HQDA CAT OF IBA REQUIREMENTS

13 DA DAMO-ODM POC IS LTC CASSELL 227-4375, E-MAIL TO CASSELLM@HQDA-AOC.ARMY.PENTAGON.MIL

BT

#6648

NNNN

* UNCLASSIFIED *

~~SECRET~~

OAASZYUW RULOEGA2143 0682109-SSSS--RUEASRT RUERPHE
ZNY SSSSS
O 091951Z MAR 03
FM COMCFLCC DOHA KUWAIT KU//C3//
TO RUFDAVC/CDRVCORPS HEIDELBERG GE//G3//
RUERBFA/CDR4INFDIV FT HOOD TX
RUHHIOA/CG I MEF FWD//G3//
RUEARSB/CDR52DORDGRP FT GILLEM GA//S3//
ZEN/COMCFLCC DOHA KUWAIT KU//C1/C2/C3/C4/C5/C6/C7/C8/C9/
/PAO/SJA/PMO/SURG/MILITARY HISTORY GROUP//
ZEN/CDR335THSIGCMD DOHA KUWAIT KU
ZEN/CDR377TH^{SC} DOHA KUWAIT KU//G3/3D MEDCOM/3D PERSCOM/3D TAMCA//
ZEN/CDP416TH ENCOM DOHA KUWAIT KU
INFO RUCAACC/CDR USCENTCOM MACDILL AFB FL//CCJ3//
RUEHDO/COMUSARCENT QA//USCENTCOM FWD/CCJ3//
RUEASRT/COMCFLCC HQS FT MCPHERSON GA//WATCH//
BT

~~SECRET~~

SECTION 1 OF 2

OPER/ENDURING FREEDOM//

MSGID/GENADMIN/COMCFLCC DOHA KUWAIT KU/0660030/MAR/CG//

SUBJ/CFLCC OEF DEPLOYMENT ORDER (DEPOD) 187B (U)//

REF/A/MSG/USCENTCOM/101656ZFEB03//

REF/B/MSG/USCENTCOM/252003ZFEB03//

REF/C/DOC/COMCFLCC/15SEP02//

REF/D/MSG/USCENTCOM/061959ZMAR03//

NARR/~~(S/REL MCFI)~~ REF A IS USCENTCOM OEF DEPOD 187 REF B IS
USCENTCOM REQUEST FOR FORCES ISC OEF SERIAL 187B. REF C IS COMCFLCC
OPERATIONS ORDER 02-099, ANTITERRORISM REF D IS USCENTCOM OEF
DEPOD 187B MOD 02. THIS IS A COMCFLCC OEF DEPOD FOR SERIAL 187B.
THIS DEPOD REFLECTS CHANGES FROM THE ORIGINAL CENTCOM DEPOD 187B.
FORCE PACKAGE T8A, SPECIFICALLY THE 173RD AIRBORNE, IS NO LONGER
OPCON TO CFLCC BUT IS OPCON TO CFSOCC (REF D, PARAGRAPH 3)
ADDITIONALLY, ONCE THE 4ID (M) FINAL DESTINATION IS DETERMINED, A
MODIFICATION TO THIS DEPOD WILL BE RELEASED THAT ESTABLISHES THEIR
COMMAND AND CONTROL RELATIONSHIPS.//

RMKS/1 ~~(S/REL MCFI)~~ CFLCC

1.A ~~(S/REL MCFI)~~ PER REF A, CFLCC ACCEPTS OPCON OF DEPLOYING FORCES
REQUESTED IN REF B, IN SUPPORT OF OEF UPON ARRIVAL IN USCENTCOM AOR.
EAD/LAD FOR THESE FORCE MODULES IS 20 FEB 03/04 APRIL 03.

1 B ~~(S/REL MCFI)~~ CFLCC MAINTAINS OPCON OF THE FOLLOWING UNITS
DEPLOYING TO KUWAIT UPON ARRIVAL IN USCENTCOM AOR

1 B 1 ~~(S/REL MCFI)~~ HHC, 244TH AVIATION BRIGADE

1 B 2 ~~(S/REL MCFI)~~ HHC, 335TH THEATER SIGNAL COMMAND (-).

1 B 3 ~~(S/REL MCFI)~~ HHC, 3RD MILITARY POLICE GROUP.

1 B 4 ~~(S/REL MCFI)~~ HHC, 455TH CHEMICAL BRIGADE

2. ~~(S/REL MCFI)~~ V CORPS. ACCEPT AS ATTACHED THE FOLLOWING FORCES
UPON THEIR ARRIVAL IN THE USCENTCOM AOR

2 A ~~(S/REL MCFI)~~ 1-13TH ARMOR BATTALION

2 B ~~(S/REL MCFI)~~ 248TH ENGINEER COMPANY

2 C ~~(S/REL MCFI)~~ 432ND CIVIL AFFAIRS BATTALION

2 D ~~(S/REL MCFI)~~ 490TH CIVIL AFFAIRS BATTALION

2 E. ~~(S/REL MCFI)~~ 172ND CHEMICAL COMPANY (SMOKE GEN).

3 ~~(S/REL MCFI)~~ I MEF ACCEPT AS ATTACHED THE FOLLOWING FORCES UPON

DECLASSIFIED
BY U.S. Central Command
DATE 15 OCT 2004

THEIR ARRIVAL IN THE USCENTCOM AOR:

- 3.A ~~(S/REL MCFI)~~ 3-27 FIELD ARTILLERY BATTALION.
- 3.B. ~~(S/REL MCFI)~~ 358 CIVIL AFFAIRS BRIGADE.
- 3 C ~~(S/REL MCFI)~~ HHD, 716 MILITARY POLICE BATTALION.
- 3 D ~~(S/REL MCFI)~~ 194TH MILITARY POLICE COMPANY.
- 3.E ~~(S/REL MCFI)~~ 442ND MILITARY POLICE COMPANY (COMBAT SUPPORT).
- 3.F ~~(S/REL MCFI)~~ 977TH MILITARY POLICE CO (COMBAT SUPPORT).
- 3 G ~~(S/REL MCFI)~~ 988TH MILITARY POLICE CO (COMBAT SUPPORT).
- 4. ~~(S/REL MCFI)~~ 377TH THEATER SUPPORT COMMAND ACCEPT AS ATTACHED
THE FOLLOWING FORCES UPON THEIR ARRIVAL IN THE USCENTCOM AOR.
- 4 A ~~(S/REL MCFI)~~ 3RD AG HHC PERSONNEL COMMAND (TYPE B).
- 4 B ~~(S/REL MCFI)~~ 3RD MEDICAL TEAM (INFECTIOUS DISEASE).
- 4 C ~~(S/REL MCFI)~~ 3RD QM TM (PETRL LIAISON TM).
- 4.D ~~(S/REL MCFI)~~ 3RD TAMC (-)
- 4 E ~~(S/REL MCFI)~~ 8TH HQ CPS (LOG PLANNING AUGMENTATION TEAM).
- 4 F ~~(S/REL MCFI)~~ 19TH QUARTERMASTER COMPANY (QM PETRL PL TML).
- 4.G ~~(S/REL MCFI)~~ 195TH TRANSPORTATION COMPANY (DET CONTRACT).
- 4.H ~~(S/REL MCFI)~~ 42ND MILITARY POLICE TEAM (EXPL DET DOG TEAM).
- 4 I ~~(S/REL MCFI)~~ 44TH HQ CPS (HHD COPRS SUPPORT BN).
- 4 J ~~(S/REL MCFI)~~ 44TH MED TEAM (PATHOLOGY)
- 4 K ~~(S/REL MCFI)~~ HHD, 49TH FINANCE BATTALION
- 4 L ~~(S/REL MCFI)~~ HHC, 49TH QUARTERMASTER GROUP.
- 4 M ~~(S/REL MCFI)~~ 51ST MILITARY POLICE TEAM (EXPL DET DOG TEAM).
- 4 N ~~(S/REL MCFI)~~ 72ND MILITARY POLICE COMPANY (MP GUARD CO).
- 4 O ~~(S/REL MCFI)~~ 88TH MILITARY POLICE COMPANY (MP CO COMBAT SPT).
- 4 P ~~(S/REL MCFI)~~ 94TH TRANSPORTATION COM (MVMT CONTROL TM).
- 4 Q. ~~(S/REL MCFI)~~ A AND B COMPANY, 109TH MEDICAL BATTALION (MEDICAL
COMPANY AREA SUPPORT).
- 4 R ~~(S/REL MCFI)~~ HHD, 450TH TRANS COM (MVMT CTL).
- 4 S. ~~(S/REL MCFI)~~ 109TH TRANSPORTATION COM (MDM TRK)
- 4.T ~~(S/REL MCFI)~~ 125TH QM CO (WATER SUPPLY COMPANY)
- 4 U ~~(S/REL MCFI)~~ 133RD MILITARY POLICE COMPANY (COMBAT SPT).
- 4 V ~~(S/REL MCFI)~~ 133RD QM TEAM (TAC WATER DISTRIBUTION).
- 4 W ~~(S/REL MCFI)~~ 135TH HQ REAR OPERATIONS CENTER ASG.
- 4 X. ~~(S/REL MCFI)~~ 139TH HQ CPS (REAR CP OPERATIONS CELL).
- 4 Y ~~(S/REL MCFI)~~ 143RD TRANSPORTATION COM (HHC TRANS COMMAND)
- 4 Z. ~~(S/REL MCFI)~~ 149TH FINANCE DETACHMENT
- 4 AA ~~(S/REL MCFI)~~ 149TH TC DETACHMENT (HVY CRANE DET PREPO).
- 4 AB. ~~(S/REL MCFI)~~ 186TH MILITARY POLICE COMPANY (GUARD CO).
- 4 AC ~~(S/REL MCFI)~~ 199TH TRANSPORTATION COM DET (MVMT CTL TM).
- 4 AD ~~(S/REL MCFI)~~ 202ND QM DET (WATER PRDET PREPO)
- 4 AE ~~(S/REL MCFI)~~ 207TH MED TEAM (HEAD & NECK SURGERY).
- 4.AF ~~(S/REL MCFI)~~ 220TH MILITARY POLICE (HHC MP BDE).
- 4 AG ~~(S/REL MCFI)~~ HHC, 226TH AREA SPT GP
- 4 AH ~~(S/REL MCFI)~~ 229TH MILITARY POLICE COMPANY (GUARD CO)
- 4 AJ ~~(S/REL MCFI)~~ 240TH QUARTERMASTER BATTALION.
- 4 AJ ~~(S/REL MCFI)~~ 249TH FINANCE DETACHMENT
- 4 AK ~~(S/REL MCFI)~~ 257TH MED TEAM (DENTAL SERVICES).
- 4 AL ~~(S/REL MCFI)~~ 260TH QM HHC (PETROLEUM SUPPORT BATTALION).
- 4 AM ~~(S/REL MCFI)~~ 266TH QM TEAM (WATER PURIFYING TEAM)
- 4.AN ~~(S/REL MCFI)~~ 267TH QM TEAM (WATER PURIFYING TEAM).
- 4 AO. ~~(S/REL MCFI)~~ 277TH ORDNANCE COMPANY (MAINT NONDIV DS)
- 4 AP ~~(S/REL MCFI)~~ 310TH AG HHD (PERSONNEL GROUP)
- 4 AQ ~~(S/REL MCFI)~~ 314TH MILITARY POLICE COMPANY (GUARD CO)
- 4.AR. ~~(S/REL MCFI)~~ 320TH CHEMICAL COMPANY (CORPS TA).
- 4 AS. ~~(S/REL MCFI)~~ 320TH HHC MILITARY POLICE BATTALION (EPW/CI).
- 4 AT ~~(S/REL MCFI)~~ 320TH MILITARY POLICE COMPANY (ESCORT GUARD CO)

4 AU. ~~(S/REL MCFI)~~ 324TH HHC MILITARY POLICE BATALLION (EPW/CI).
4 AV. ~~(S/REL MCFI)~~ 325TH TRANS COM (MDM TRK CO 5000 GAL TANK).
4 AW. ~~(S/REL MCFI)~~ 343RD MILITARY POLICE TM EPW (I/R BDE LIAISON).
4 AX ~~(S/REL MCFI)~~ 346TH MILITARY POLICE DET EPW (I/R CP LIAISON)
4 AY ~~(S/REL MCFI)~~ 349TH FINANCE DETACHMENT
4 AZ ~~(S/REL MCFI)~~ 359TH TRANS COM (HHC TRANS TERMINAL BATALLION).
4 BA. ~~(S/REL MCFI)~~ 365TH HHD CORPS SUPPORT BATALLION.
4 BB ~~(S/REL MCFI)~~ 370TH TRANS COM (MDM TRK CO PLS)
4 BC. ~~(S/REL MCFI)~~ 373RD MILITARY POLICE DET EPW (I/R PROCESS SQD).
4 BD. ~~(S/REL MCFI)~~ 375TH MILITARY POLICE DET (CID CASE).
4 BE. ~~(S/REL MCFI)~~ 377TH MILITARY POLICE DET EPW (I/R PROCESS SQD).
4 BF ~~(S/REL MCFI)~~ 379TH MILITARY POLICE DET EPW (I/R PROCESS SQD).
4 BG. ~~(S/REL MCFI)~~ 381ST MILITARY POLICE TEAM EPW (I/R BDE LIAISON).
4 BH ~~(S/REL MCFI)~~ 419TH TRANS COM (HHD MOTOR TRANS).
4 BI. ~~(S/REL MCFI)~~ 439TH QM CO (PETROLEUM SUPPLY COMPANY).
4 BJ. ~~(S/REL MCFI)~~ 442ND MILITARY POLICE COMPANY (COMBAT SUPPORT).
4 BK ~~(S/REL MCFI)~~ 445TH MED DET (VET SERVICES).
4 BL ~~(S/REL MCFI)~~ 445TH QM CO (FLD SVC CO DS AOE)
4 BM ~~(S/REL MCFI)~~ 447TH MILITARY POLICE COMPANY (GUARD CO).
4 BN ~~(S/REL MCFI)~~ 459TH TRANS COM (MDM TRK CO 40 FT CNR CG).
4 BO ~~(S/REL MCFI)~~ 467TH QM HHD (SUPPLY & SERVICE B).
4 BP. ~~(S/REL MCFI)~~ 469TH FINANCE GROUP.
4 BQ ~~(S/REL MCFI)~~ 475TH TRANS COM DET (TRAILER TRANSFER POINT OP).
4 BR ~~(S/REL MCFI)~~ 497TH TRANS COM DET (TRANS LT MDM TRK CO).
4 BS. ~~(S/REL MCFI)~~ 502ND MED CO (DENTAL SERVICES).
4 BT ~~(S/REL MCFI)~~ 512TH QUARTERMASTER CO (WATER SP PREPO).
4 BU ~~(S/REL MCFI)~~ 523RD MILITARY POLICE TEAM (EXPL DET DOG TM).
4 BV ~~(S/REL MCFI)~~ 559TH QM BN (M HHD WATER SUPPORT BATALLION).
4 BW ~~(S/REL MCFI)~~ 569TH TRANS COM TEAM (MVMNT CTL-REGULATING).
4 BX ~~(S/REL MCFI)~~ 590TH TRANS COM DET (TRAILER TRANS PT OP).
4 BY ~~(S/REL MCFI)~~ 596TH TRANS COM TEAM (MVMT CTL-CARGO).
4 BZ ~~(S/REL MCFI)~~ 598TH TRANS COM DET (TRAILER TRANS PT PREPO)
4 CA ~~(S/REL MCFI)~~ 602ND TRANS COM TEAM (MVMT CTL-CARGO).
4 CB ~~(S/REL MCFI)~~ 607TH TRANS COM TEAM (MVMT CTL-REGULATING).
4 CC ~~(S/REL MCFI)~~ 625TH TRANS COM DET (MVMT CTL-REGULATING).
4 CD ~~(S/REL MCFI)~~ 647TH TRANS COM TEAM (MVMT CTL-CARGO).
4 CE ~~(S/REL MCFI)~~ 658TH COMBAT SUPPORT CO (GEN SUP)
4 CF. ~~(S/REL MCFI)~~ 691ST QM CO (FORCE PROVIDER CO)
4 CG ~~(S/REL MCFI)~~ 708TH MED CO (GROUND MED AMBULANCE CO).
4 CH ~~(S/REL MCFI)~~ 721ST AG CO (HQ POSTAL COMPANY)
4 CI ~~(S/REL MCFI)~~ 721ST AG CO (POSTAL OPS PLATOON).
4 CJ ~~(S/REL MCFI)~~ 726TH ORDNANCE HHD (ORD MNT BN DS GS).
4 CK ~~(S/REL MCFI)~~ 744TH MILITARY POLICE BN (EPW CI BN).
4 CL ~~(S/REL MCFI)~~ 755TH MILITARY POLICE CO (COMBAT SUPPORT).
4 CM. ~~(S/REL MCFI)~~ 757TH TRANS COM HHC (TRANS RAILWAY BN).
4 CN. ~~(S/REL MCFI)~~ **800TH MILITARY POLICE BDE (HHC I/R).**
4 CO ~~(S/REL MCFI)~~ 802ND QM CO (FORCE PROVIDER CO).
4 CP ~~(S/REL MCFI)~~ 809TH QM DET (PETROLEUM LIAISON TEAM).
4 CQ ~~(S/REL MCFI)~~ 814TH MILITARY POLICE CO (GUARD CO)
4 CR ~~(S/REL MCFI)~~ 823RD TRANS COM DET (MVMT CTL TM-REGULATING).
4 CS ~~(S/REL MCFI)~~ 839TH TRANS COM DET (MVMT CTL TM-REGULATING).
4 CT ~~(S/REL MCFI)~~ 849TH QM CO (SUPPLY COMPANY).
4 CU. ~~(S/REL MCFI)~~ 861ST QM CO (AD EQ CO TAACOM)
4 CV ~~(S/REL MCFI)~~ 923RD TRANS COM TEAM (TRAILER TRANSFER PT OP).
4 CW ~~(S/REL MCFI)~~ 958TH TRANS COM TEAM (MVMT CTL TM-REGULATING)
4 CX ~~(S/REL MCFI)~~ 977TH MILITARY POLICE CO (COMBAT SUPPORT).
4 CY ~~(S/REL MCFI)~~ 988TH MILITARY POLICE CO (COMBAT SUPPORT).

4. CZ. ~~(S/REL MCFI)~~ 1034 COMBAT SUPPORT CO (QM SUPPLY CO).
 4 DA ~~(S/REL MCFI)~~ 1057 TRANS COM CO (LT MDM TRK CO).
 4 DB ~~(S/REL MCFI)~~ 1083 TRANS COM CO (COMBAT HET CO).
 4 DC ~~(S/REL MCFI)~~ 1128 TRANS COM CO (MDM TRK CO PLS).
 4 DD ~~(S/REL MCFI)~~ 1136 TRANS COM CO (MDM TRK CO 20 FT CNR CG).
 4. DE ~~(S/REL MCFI)~~ 1138 MILITARY POLICE CO (GUARD CO).
 4 DF ~~(S/REL MCFI)~~ 1150 TRANS COM CO (TRANS RAILWAY OPS CO).
 4. DG. ~~(S/REL MCFI)~~ 1175 TRANS COM CO (COMBAT HET CO)
 4 DH ~~(S/REL MCFI)~~ 163RD MILITARY POLICE TEAM (NARCOTICS DET D)
 4 DI ~~(S/REL MCFI)~~ 163RD MILITARY POLICE TEAM (KENNELMASTER TM).
 4 DJ ~~(S/REL MCFI)~~ 1742 TRANS COM CO (MDM TRK CO 40 FT CNR CG).
 4. DK ~~(S/REL MCFI)~~ 178TH MP TEAM (NARCOTICS DETACHMENT DOG TEAM).
 4 DL ~~(S/REL MCFI)~~ 179TH MILITARY POLICE DET (EXPL DET DOG TEAM).
 4 DM ~~(S/REL MCFI)~~ 3662 ORDNANCE CO (GS MAINTENANCE CO).
 4 DN. ~~(S/REL MCFI)~~ 452ND MED HOSP (COMBAT SUPPORT).
 4 DO. ~~(S/REL MCFI)~~ 535TH MILITARY POLICE BN (EPW CI BN).
 4 DP. ~~(S/REL MCFI)~~ 801ST MED HOSP (COMBAT SUPPORT).
 5 ~~(S/REL MCFI)~~ 416TH ENGINEER COMMAND. ACCEPT AS ATTACHED THE
 FOLLOWING FORCES UPON THEIR ARRIVAL IN THE USCENCOM AOR:
 5. A. ~~(S/REL MCFI)~~ 30TH ENGINEER BN (HHC ENGR TOPO BN TA).
 5 B ~~(S/REL MCFI)~~ 100TH ENGINEER CO (TOPO ENGR CO).
 5. C. ~~(S/REL MCFI)~~ 132ND ENGINEER DET (TOPO PLANNING CONTROL).
 5 D ~~(S/REL MCFI)~~ 186TH ENGINEER TEAM (UTILITIES 4000 TEAM).
 5 E ~~(S/REL MCFI)~~ 212TH ENGINEER CO (ENGR CO DUMP TRUCK)
 5 F ~~(S/REL MCFI)~~ 244TH ENGINEER BN (ENGR CBT BN)
 5 G ~~(S/REL MCFI)~~ 247TH ENGINEER TEAM (ENG EQUIP TEAM PREPO).
 5 H ~~(S/REL MCFI)~~ 249TH ENGINEER BN (PRIME POWER BN).
 5 I ~~(S/REL MCFI)~~ 308TH ENGINEER DET (REAL ESTATE TEAM).
 5 J ~~(S/REL MCFI)~~ 319TH ENGINEER CO (CONSTRUCTION SUPPORT).
 5 K ~~(S/REL MCFI)~~ 323RD ENGINEER PLATOON (FFTG TEAM FIRE TRUCK).
 5 L ~~(S/REL MCFI)~~ 323RD ENGINEER PLATOON (FFTG TEAM WATER TRUCK).
 5 M ~~(S/REL MCFI)~~ 332ND ENGINEER CO (DUMP TRUCK).
 5. N ~~(S/REL MCFI)~~ 369TH ENGINEER PLATOON (FFTG TEAM WATER TRUCK).
 5 O ~~(S/REL MCFI)~~ 369TH ENGINEER PLATOON (FFTG TEAM FIRE TRUCK).
 5. P ~~(S/REL MCFI)~~ 369TH ENGINEER PLATOON (FFTG TEAM FIRE TRUCK)
 5 Q ~~(S/REL MCFI)~~ 369TH ENGINEER PLATOON (WATER PREPO).
 5 R ~~(S/REL MCFI)~~ 369TH ENGINEER PLATOON (FFTG TEAM FFTG HQ)
 5 S. ~~(S/REL MCFI)~~ 829TH ENGINEER TEAM (UTILITIES 4000 TEAM).
 5 T. ~~(S/REL MCFI)~~ 926TH ENGINEER HHC (HHC COMBAT ENGINEER).
 5 U ~~(S/REL MCFI)~~ 1030 ENGINEER BN (HQ TEAM).
 5. V ~~(S/REL MCFI)~~ 1193 ENGINEER CO (PANEL BRIDGE)
 5 W. ~~(S/REL MCFI)~~ 1438 ENGINEER TEAM (UTILITIES 4000 TEAM)
 5 X ~~(S/REL MCFI)~~ USA FACILITIES ENGINEERING GROUP
 5 Y ~~(S/REL MCFI)~~ USA FACILITIES ENGINEERING GROUP CT3
 5 Z ~~(S/REL MCFI)~~ USA FACILITIES ENGINEERING GROUP SE3
 6 ~~(S/REL MCFI)~~ CFLCC SJA ACCEPT AS ATTACHED THE FOLLOWING FORCES
 UPON THEIR ARRIVAL IN THE USCENCOM AOR: 153 JAG DETACHMENT.
 7 ~~(S/REL MCFI)~~ 335TH THEATER SIGNAL COMMAND ACCEPT AS ATTACHED
 THE FOLLOWING FORCES UPON THEIR ARRIVAL IN THE USCENCOM AOR.
 7 A. ~~(S/REL MCFI)~~ 19TH SIGNAL COMPANY (COMTEL CO-XXI).
 7 B ~~(S/REL MCFI)~~ 269TH SIGNAL COMPANY
 7 C ~~(S/REL MCFI)~~ 69TH SIGNAL COMPANY CABLE AND WIRE CO CP.
 7 D. ~~(S/REL MCFI)~~ 114TH SIGNAL COMPANY (TROPO LIGHT)
 7 E ~~(S/REL MCFI)~~ 151ST SIGNAL BATTALION (TELECOM BN AREA)
 7 F ~~(S/REL MCFI)~~ HHD, 504TH SIGNAL BATTALION (TELECOM BN AREA).
 7. G ~~(S/REL MCFI)~~ 313TH SIGNAL COMPANY.
 8 ~~(S/REL MCFI)~~ 244TH AVIATION BRIGADE ACCEPT AS ATTACHED THE

FOLLOWING FORCES UPON THEIR ARRIVAL IN THE USCENTCOM AOR:

8 A. ~~(S/REL MCFI)~~ 109TH AVIATION MAINTENANCE COMPANY.//

FINAL SECTION OF 2

RMKS/8.B ~~(S/REL MCFI)~~ E COMPANY, 111 AVIATION BATTALION (ATS).

8.C ~~(S/REL MCFI)~~ 110TH WEATHER FLIGHT

8 D. ~~(S/REL MCFI)~~ 147TH AVIATION BN (EAC).

8.E ~~(S/REL MCFI)~~ B COMPANY, 159TH AVIATION BN.

8 F ~~(S/REL MCFI)~~ HHC, 159TH AVIATION BN.

8 G. ~~(S/REL MCFI)~~ 228TH AVIATION BN HHC THEATER ARMY AVN BN.

8.H ~~(S/REL MCFI)~~ 228TH AVIATION BN THEATER AVIATION COMPANY C-12

9 ~~(S/REL MCFI)~~ ARCENT-QATAR. ACCEPT AS ATTACHED THE FOLLOWING FORCES UPON THEIR ARRIVAL IN THE USCENTCOM AOR.

9 A ~~(S/REL MCFI)~~ 938 ENGINEER TEAM, FFTG HQ.

9.B ~~(S/REL MCFI)~~ 938 ENGINEER TEAM, FIRE TRUCK.

9.C ~~(S/REL MCFI)~~ 938 ENGINEER TEAM, WATER TRUCK

10. ~~(S/REL MCFI)~~ CFLCC MILITARY HISTORY GROUP . ACCEPTS AS ATTACHED THE FOLLOWING FORCES UPON THEIR ARRIVAL IN THE USCENTCOM AOR:

10 A 30TH MILITARY HISTORY DETACHMENT (DS TO THE 75TH EXPLOITATION TASK FORCE)

10.B ~~(S/REL MCFI)~~ 35TH MILITARY HISTORY DETACHMENT (DS TO THE 377TH THEATER SUPPORT COMMAND.

11 ~~(S/REL MCFI)~~ 352ND CIVIL AFFAIRS COMMAND. ACCEPT AS ATTACHED THE FOLLOWING FORCES UPON THEIR ARRIVAL IN THE USCENTCOM AOR: 126TH MILITARY HISTORY COMPANY (DET)

12 (U) COORDINATING INSTRUCTIONS

12.A ~~(S/REL MCFI)~~ C-DAY: IAW CURRENT 103ID/IR TPFDD AS APPLICABLE.

12.B ~~(S/REL MCFI)~~ DURATION FOR THE DURATION OF OEF (UNLESS OTHERWISE DIRECTED)

12.C ~~(S/REL MCFI)~~ RULES OF ENGAGEMENT (ROE) CJCS STANDING ROE; USCENTCOM THEATER-SPECIFIC ROE, TEXT OF FOREGOING ROE ARE AVAILABLE AT THE CFLCC WEBSITE

WWW.SWA ARCENT.ARMY.SMIL MIL/SECTIONS/SJA/DOCS/ROE/UPDATE.CFM.

ADDITIONAL ROE WILL BE DISSEMINATED AS THE NEED ARISES.

12.D (U) FORCE PROTECTION

12 D.1 (U) PREDEPLOYMENT REQUIREMENTS DEPLOYING UNIT COMMANDERS WILL APPOINT IN WRITING A PRIMARY AND ALTERNATE ANTITERRORISM (AT) OFFICER TO DEVELOP, IMPLEMENT, AND SUPERVISE THE ORGANIZATION'S AT PROGRAM PRIOR TO DEPLOYMENT OF ANY KIND TO THE CFLCC AOR, ALL UNITS AND ELEMENTS MUST COMPLETE AND COORDINATE AN ANTITERRORISM PLAN FOR THEIR OPERATION FOR A COMPLETE DESCRIPTION OF PREDEPLOYMENT REQUIREMENTS REFER TO APPENDIX 4, ANNEX C, ARCENT OPERATIONS ORDER 02-099 (REF C).

12.D 2 (U) CFLCC HAS ANTITERRORISM/FORCE PROTECTION RESPONSIBILITY FOR ALL MILITARY PERSONNEL, DEPARTMENT OF DEFENSE CIVILIANS, DESIGNATED CONTRACTORS ASSIGNED, ATTACHED, TEMPORARY DUTY OR IN-TRANSIT TO CFLCC OR LOCATED ON CFLCC FACILITIES/INSTALLATIONS TO INCLUDE TENANT UNITS. COMMANDERS WILL ENSURE ALL FORCES DEPLOYED ARE AWARE OF THE THREAT LEVELS AND FORCE PROTECTION CONDITIONS SET BY CFLCC, AND ALL FORCES COMPLETE CFLCC REQUIRED PREDEPLOYMENT TRAINING, AS APPLICABLE, TO INCLUDE ANTITERRORISM AWARENESS TRAINING IAW ARCENT OPORD 02-099, ANTI-TERRORISM OPORD, 15 SEP 02 ARCENT COMMANDERS WILL ENSURE DEPLOYED FORCES RECEIVE THE APPROPRIATE LEVEL OF TERRORIST AWARENESS TRAINING UPON ARRIVAL AND, AS REQUIRED, THROUGHOUT THE LENGTH OF DEPLOYMENT IN THE AOR. ENSURE FORCE PROTECTION MEASURES INCLUDE PROVISION FOR CONTRACTORS THAT ARE INVOLVED IN THE OPERATION.

12 D 3 (U) REQUIRED INDIVIDUAL PREDEPLOYMENT TRAINING INCLUDES BUT

IS NOT LIMITED TO THE FOLLOWING:

12 D.3.A (U) VIEWING THE ARMY PERSONAL AWARENESS VIDEO PROVIDED UNDER THE INSTRUCTION OF A CERTIFIED LEVEL II AT INSTRUCTOR AND/OR VIEWING THE CJCS-APPROVED WEB-BASED INSTRUCTION.

12 D 3 B (U) VIEWING VIDEO/LEVEL II AT INSTRUCTOR OR COMPLETION OF WEB-BASED INSTRUCTION COVERING AN INTRODUCTION TO TERRORISM, TERRORIST OPERATIONS, INDIVIDUAL PROTECTIVE MEASURES, TERRORIST SURVEILLANCE TECHNIQUES, IMPROVISED EXPLOSIVE DEVICE ATTACKS, KIDNAPPING AND HOSTAGE SURVIVAL, AND TERRORISM THREAT LEVELS AND THE FPCON SYSTEM

12.D.3.C (U) ISSUANCE OF GTA 19-4-3 "INDIVIDUAL PROTECTIVE MEASURES".

12.D.3.D (U) CULTURAL ASPECTS OF HOST COUNTRY(IES).

12 D.3.E (U) RULES OF ENGAGEMENT (WHEN APPLICABLE)

12.D 3 F (U) USE OF DEADLY-FORCE (FOR PERSONNEL PERFORMING ARMED SECURITY DUTIES AND ANTITERRORISM OFFICER).

12.D.4 (U) REQUIRED UNIT PREDEPLOYMENT TRAINING INCLUDES BUT IS NOT LIMITED TO THE FOLLOWING

12.D 4 A (U) ALL INDIVIDUAL TRAINING SPECIFIED ABOVE.

12 D 4 B (U) ANTITERRORISM MEASURES DURING TRANSIT TO THE DEPLOYMENT LOCATION

12 D 4 C (U) DETERRENCE ANTITERRORISM MEASURES SPECIFIC TO THE DEPLOYMENT LOCATION.

12.D.5 (U) REQUIRED UNIT TRAINING AT THE DEPLOYED LOCATION INCLUDES BUT IS NOT LIMITED TO THE FOLLOWING:

12 D 5.A. (U) IMMEDIATE INCIDENT RESPONSE AND POST-INCIDENT ACTIONS IAW INSTALLATION AT PLAN.

12 D 5 B (U) WORKING WITH HN SECURITY.

12 D 5 C (U) EFFECTIVENESS OF COMMAND AND CONTROL SYSTEMS.

12 D 5.D (U) REHEARSALS WITH ANTI-TERRORISM EQUIPMENT.

12 E (S/REL MCFI) STATUS OF FORCES UNDER PROVISIONS OF THE US-KUWAIT DEFENSE COOPERATIVE AGREEMENT, SERVICE MEMBERS IN KUWAIT HAVE ADMINISTRATIVE AND TECHNICAL STATUS IAW THE VIENNA CONVENTION. COMMANDERS WILL ENSURE PERSONNEL OPERATING IN OTHER COUNTRIES IN THE AOR RECEIVE AN IN-COUNTRY LEGAL BRIEF FROM THEIR STAFF JUDGE ADVOCATE

12.F (U) MEDICAL. PER USCINCENT MESSAGE DTG 032024Z OCT 01 SUBJECT USCENCOM PERSONNEL POLICY GUIDANCE

12 G (U) FOOT AND MOUTH DISEASE (FMD) ALERT ALL DOD-SPONSORED PERSONNEL AND/OR EQUIPMENT MOVING WITHIN OR EXITING FROM AN FMD-AFFECTED REGION WILL COMPLY WITH DOD REGULATION 4500 9-R (DEFENSE TRANSPORTATION REGULATION) AND THE LATEST FMD GUIDANCE PROVIDED BY THE RESPECTIVE HOST NATION AS LONG AS SAID GUIDANCE IS CONSISTENT WITH THE GUIDANCE ON SOVEREIGN IMMUNITY FOUND IN USCINCEUR MESSAGE 061136ZAPR01 AND USAF MESSAGE 101500ZAPR01, AS WELL AS CONTINGENCY OPERATIONS AND UNIT DEPLOYMENTS OF 15 DAYS OR LONGER, ANY SPECIAL GUIDANCE ON SOVEREIGN IMMUNITY OF US AIRCRAFT AND FMD RECEIVED FROM OSD, THE THEATER COMMANDER, AND USDA. A LISTING OF CURRENT FMD-AFFECTED COUNTRIES MAY BE FOUND IN THE DAILY EMERGENCY OPERATIONS CENTER (EMOC) NOTICES POSTED ON THE USDA WEB PAGE, [HTTP://WWW.APHIS.USDA GOV/VS/NCIE/COUNTRY.HTML](http://www.aphis.usda.gov/vs/ncie/country.html) (LOWER CASE) ADDITIONAL INFORMATION IS CONTAINED IN SECDEF ATSD(CS) MESSAGE 211600ZMAY01 "FIELD INSTRUCTIONS FOR MOVEMENT OF MILITARY EQUIPMENT, PERSONNEL, PERSONAL PROPERTY, CARGO, AND MAIL TO THE UNITED STATES FROM COUNTRIES AFFECTED WITH FMD."

13.H. (U) CONCURRENT UNIFORM CODE OF MILITARY JUSTICE AUTHORITY, INCLUDING ARTICLE 15 AUTHORITY, TRANSFERS TO COMCFLCC WITH OPCON.

COMUSCENTCOM GENERAL ORDER NUMBER 1A (19DEC00) IN EFFECT, PROHIBITING, AMONG OTHER THINGS, THE CONSUMPTION OF ALCOHOL AND THE TAKING OF WAR TROPHIES IN THE CENTCOM AOR. FOR COMPLETE TEXT SEE: RECLUSE CENTCOM.SMIL MIL/CRISIS/CATDESKS/JAG/MSGG/GENERAL_ORDER_1A_(GO-1A).DOC.

12 I. (U) TRAINING PERSONNEL DESIGNATED AS HIGH RISK-OF-CAPTURE BY THEIR SERVICE MUST UNDERGO USCENTCOM THEATER SURVIVAL, EVASION, RESISTANCE AND ESCAPE (SERE) PREPARATION, PRIOR TO DEPLOYMENT IAW USCINCCENT MESSAGE 301308Z JUL 01 DESIGNATED HRC PERSONNEL MUST CONTACT USCENTAF A3-DOOR AT DSN 965-2959/60 TO ARRANGE PREPARATION.

12.J (U) ORDER EFFECTIVE UPON RECEIPT.

12.K (U) DEPLOYING UNITS WILL BRING ALL MTO&E AND CTA AUTHORIZED LIFE SUPPORT EQUIPMENT (I E TENTS, COTS, LIGHT SETS, ETC.) TO PROVIDE BASIC LIFE SUPPORT TO UNIT PERSONNEL.

12.L (S/REL GCTF) DEPLOYING UNITS WILL ENSURE VEHICLES AND PERSONNEL ARE MARKED IAW THE CFLCC COMBAT IDENTIFICATION STANDARDS. THE CFLCC COMBAT ID STANDARDS ARE DESCRIBED IN COMCFLCC FRAGO 21 TO COMCFLCC OPERATIONS ORDER 02-084, CFLCC COMBAT IDENTIFICATION STANDARDS, 040600ZJAN03 THIS FRAGO IS LOCATED AT [HTTP://WWW SWA ARCENT.ARMY SMIL MIL/ORDERS_MANAGER/MESSAGES/CFLCC_ORDERS_IN_EFFECT/CFLCC_ORDERS_MATRIX.XLS](http://www.swa.arcnet.army.smil.mil/orders_manager/messages/cflcc_orders_in_effect/cflcc_orders_matrix.xls).

13. (U) AIRLIFT MOVEMENT.

13 A (U) AIRLIFT MOVEMENT PRIORITY AND AIR REFUELING PRIORITY 1B1.

13 B. (U) INDIVIDUALS OR SMALL GROUPS TRAVELING VIA COMMERCIAL AIR OR ROTATOR FLIGHTS IN AND OUT OF THE USCENTCOM AOR WILL WEAR CIVILIAN CLOTHING DURING TRAVEL. GROUPS OR UNITS AUTHORIZED TRAVEL IN PRESCRIBED UNIFORMS WILL CARRY APPROPRIATE CONSERVATIVE CIVILIAN CLOTHING FOR USE DURING EXTENDED TRANSIT DELAYS AT COMMERCIAL AIRPORTS

14 (S/REL GCTF) THE USE OF JOPEs IS DIRECTED FOR ALL STRATEGIC MOVEMENTS THE USE OF JOPEs IS REQUESTED FOR SAAMS MOVEMENT TO PROVIDE VISIBILITY FOR HEADQUARTERS AND COMPONENT STAFFS. UTILIZE PID 103AC/103HD FOR DEPLOYMENT AND 103AR/103HR FOR REDEPLOYMENT AS APPLICABLE USE GCCS NEWSGROUP CENTCOM JOPEs.OPS2/CENTCOM.JOPEs.HOA AS APPLICABLE FOR COORDINATION AND VERIFICATION OF ALL JOPEs TRANSACTIONS.

15 (U) PUBLIC AFFAIRS.

15 A (U) PA POSTURE PUBLIC AFFAIRS POSTURE WILL BE PASSIVE UNTIL OSD FORMAL ANNOUNCEMENT OF DEPLOYMENT ORDER. UPON OSD ANNOUNCEMENT OF THE DEPLOYMENT ORDER, UNITS MAY ACKNOWLEDGE THE UNIT'S DEPLOYMENT TO KUWAIT IN RESPONSE TO QUERY. FOR THOSE UNITS GOING TO JORDAN, UNITS MAY ACKNOWLEDGE RECEIPT OF A DEPLOYMENT ORDER TO THE CENTCOM AOR. ONCE UNITS ARRIVE IN KUWAIT, PA POSTURE IS ACTIVE IN ACCORDANCE WITH PROCEDURES ESTABLISHED PPAG FOR MODEP. PA PERSONNEL SHOULD COORDINATE ALL MEDIA ACTIVITIES WITH THE CFLCC PAO FOR COORDINATION WITH THE U.S EMBASSY WHC WILL, IN TURN, FURTHER COORDINATE WITH GOK.

15 B (U) PA APPROACH CFLCC WILL MAINTAIN THE CURRENT PASSIVE/RESPONSE TO QUERY PUBLIC AFFAIRS POSTURE. UPON OSD ANNOUNCEMENT OF THE DEPLOYMENT ORDER, UNITS MAY ACKNOWLEDGE RECEIPT OF A DEPLOYMENT ORDER AND DISCUSS GENERIC MISSIONS FOR THE UNIT COMMANDERS MAY PERMIT MEDIA COVERAGE OF DEPLOYING UNITS PREPARING FOR DEPLOYMENT COMMANDERS ARE NOT AUTHORIZED TO EMBED MEDIA WITH DEPLOYING GROUND FORCES AT THIS TIME, HOWEVER, EMBEDDED MEDIA AUTHORIZATION IS ANTICIPATED AND INTERESTED UNITS MAY SUBMIT AN EMBED PLAN THROUGH COMMAND CHANNELS TO CFLCC PAO TO FACILITATE STREAMLINED APPROVAL. NO DISCUSSION OF OPERATIONAL DETAILS IS

AUTHORIZED NO DISCUSSION OF INTELLIGENCE INFORMATION IS AUTHORIZED.

15.C (U) THE FOLLOWING STATEMENT MAY BE USED IN RESPONSE TO QUERY:

(QUOTE) THE (UNIT OR ELEMENTS OF THE UNIT) IS DEPLOYING TO KUWAIT (OR CENTCOM AOR) TO SUPPORT THE PRESIDENT'S GLOBAL WAR ON TERRORISM AND TO PREPARE FOR FUTURE CONTINGENCIES AS MAY BE DIRECTED. THE PRESIDENT OF THE UNITED STATES HAS MADE NO DECISION ABOUT MILITARY ACTION AGAINST IRAQ, HOWEVER, OUR FORCES ARE TRAINED, PREPARED AND READY SHOULD THEY BE CALLED UPON. THESE DEPLOYMENTS ARE A PRUDENT STEP TO INCREASE MILITARY CAPABILITIES IN THE REGION. FOR MORE INFORMATION, CONTACT THE COALITION FORCES LAND COMPONENT COMMAND PUBLIC AFFAIRS OFFICE AT 011-965-468-2289/8040/8031. (UNQUOTE).

16 (U) FUNDING. CFLCC WILL FUND ALL COSTS OF THIS OPERATION, INCLUDING DEPLOYMENT AND REDEPLOYMENT COSTS. CFLCC WILL CAPTURE AND REPORT TO SERVICE COMPTROLLERS INCREMENTAL COSTS FOR DEPLOYMENTS IN SUPPORT OF THIS OPERATION.

17. (U) COMMUNICATIONS GUIDANCE. ALL UNITS MUST BRING SWA-AOR CURRENT PLUS NINETY DAY INTERTHEATER COMSEC PACKAGES (ICP). INCOMING UNITS MUST COORDINATE COMMUNICATIONS REQUIREMENTS THROUGH THEIR HIGHER HEADQUARTERS SIGNAL CHANNELS MAJOR SUBORDINATE COMMANDS COORDINATE COMMUNICATIONS REQUIREMENTS TO THE 335TH THEATER SIGNAL COMMAND (335 TSC) THE 335 TSC MANAGES THE THEATER COMSEC MANAGEMENT OFFICE (TCMO) AND SPECTRUM MANAGEMENT CFLCC C6 PRIORITIZES FREQUENCY ALLOCATIONS, SATELLITE CHANNELS, AND CIRCUITS AS REQUIRED UNITS ARRIVING IN THEATER SHOULD BRING ALL REQUIRED END USER AUTOMATION AND COMMUNICATION SYSTEMS TO INCLUDE SECURE AND NONSECURE TELEPHONES, COMPUTERS, AND PRINTERS. UNITS SHOULD ALSO BRING NETWORKING EQUIPMENT FOR LOCAL AREA NETWORKS TO INCLUDE HUBS, ROUTERS, SERVERS, ETC ONCE BROUGHT INTO THEATER, UNITS WILL CONFIGURE IAW THEATER POLICY

18 (U) POC IS MAJ CHRIS GEREN, 438-7536, EMAIL

EFWOLBERTG@SWA ARCENT ARMY.SMIL.MIL //

DECL/07MAR13//

BT

#2143

NNNN

* ~~SECRET~~ *

tainee Status

AS OF 131900ZMar04

UNCLASSIFIED

DETENTION FACILITIES

	Yesterday	Today	Adjustments
112 MP BN Special Confinement Facility (RI/AP/ RVQI)	93	93	
191 MP BN (Camp, Vigilant) BCCF	684	672	
191 MP BN (Camp, Ganci) BCCF	5119	5143	
191 MP BN (Baghdad Central Correctional Facility) BCCF	1456	1458	
191 MP BN (Baghdad Central Correctional Facility, Medical) v/h	28	27	
MNB N DCCP (v/c Mosul)	65	70	
Subtotal	7719	7738	

OTHER LOCATIONS

Med Cal Chemicals	15	8	
In Transit	1	1	
530th MP BN (Camp Asimel)	3840	3848	
Subtotal	3856	3857	

THEATER

160th MP BN Camp Bucca (Umm Qasr)	1770	1771	
Subtotal	1770	1771	

TOTAL

	13754	13366	
		12	

TRANSFERS

- 1 BUCCA received from CASH CI
- 1 Vigilant received from Ganci CI
- 31 Ganci received from Vigilant CI
- 7 Ganci received from IID CI
- 1 BCF Medical Wing received from CASH CI
- 3 BCF Prison received from BCF Medical Wing CR

- 1 CASH transferred to BUCCA CI
- 11 Ganci transferred to Vigilant CI
- 33 Vigilant transferred to Ganci CI
- 7 IID transferred to Ganci CI
- 1 CASH transferred to BCF Medical Wing CI
- 1 BCF Medical Wing transferred to BCF Prison CR

IN TRANSIT

- 1 Ganci transferred to Bucca 1 CI, Jurriatic

IMPACT

NONE

NOTES

ACCOUNTABILITY JUSTIFICATION

LOSSES

- 1 Medical administrative adjustment for reporting error (CI)
- 5 Medical administrative adjustment for reporting error (CI)
- 5 Ganci administrative adjustment for reporting error (CI)
- 1 BCF Prison administrative adjustment for reporting error (CI)

GAINS

- 5 MNB N new capture CI
- 11 IID new capture CI
- 7 Ganci administrative adjustment for reporting error CI
- 1 BCF Medical Wing administrative adjustment for reporting error CI

24

12

12

9/10



REPLY TO
ATTENTION OF

DEPARTMENT OF THE ARMY
COALITION FORCES LAND COMPONENT COMMAND
HEADQUARTERS THIRD UNITED STATES ARMY
UNITED STATES ARMY FORCES CENTRAL COMMAND
APO AE 09304

AFRD-JA

9 March 2004

MEMORANDUM FOR RECORD

SUBJECT Investigative Observations and Interviews

- 1 On or about 7 February 2004, I talked to several members of the 320th MP Battalion at Abu Gharib (BCCF), Iraq regarding accountability and detainee processing at that facility
- 2 During a tour of the Hard-Site, I visited the MP Guard orderly room located within the Hard-Site. I spoke with the NCOIC of that particular shift who verbally walked me through the "roll-call," and "call-up" procedures practiced within the Hard-Site. Of particular note was his concerns about the way ISN counts were done and reconciled with the manifests they were provided by the Battalion S-1, CPT [REDACTED]. He explained that the Hard-Site, and the other holding areas receive a detainee manifest that lists every detainee they should have in their respective areas. However, they are NEVER accurate. He further added that the manifest is usually off by at least 4 or 5 detainees, but often has a dozen or more inaccuracies. When asked why he thought this was happening, he told me that he believed that the Battalion S-1 shop was always "way behind in processing the change sheets" that are handed into them every day. He explained that a change sheet is the form used to document the movement of a detainee from one location to another (i.e. a different holding area, hospital, court, etc.). Thus, if the manifest is not updated in a timely manner, the manifest will not be accurate and makes his job very confusing and frustrating.
- 3 As a follow-up to the discussion detailed in paragraph 2 above, I discussed the issue with the Battalion S-1, CPT [REDACTED] and the Battalion S-3, Major [REDACTED]. They confirmed that the manifests were not accurate due to a delay, in many cases 4 or more days, in processing the change sheets. They further informed me that they needed at least 12 additional Soldiers dedicated to the processing of change sheets if they were to have accurate manifests/counts.
- 4 I also talked to several junior enlisted MPs while at Abu Gharib (BCCF) about how they conduct head counts of the detainees. Nearly every soldier had a different method in which they made these counts. Depending on what tent and compound you were in and who your NCOIC was at any particular time, the counts could be moving all the detainees to one end of the tent and counting them as they moved to the other end, lining the detainees up in row of 10 and physically counting the rows, removing them from the tent and having them stand along the fence, or walking them from one compound to another and counting them as they enter the second compound. There was no SOP being enforced when doing physical counts.

AFRD-JA

SUBJECT. Investigative Observations and Interviews

5 During the week of March 7th through the 13th 2004, I spoke with BG Janis Karpinski on the phone regarding reprimands she may have given SGM [REDACTED] 800th MP Brigade. She informed me that she had given him two written Letters of Admonishment and several verbal reprimands.

6 POC for this memorandum for record is the undersigned at DSN 318-438-8018

//original signed//

[REDACTED]

CPT, JA

Chief of Military Justice (CFLCC)

~~Classification SECRET//X1~~

- 1 NA
- 2 Type of incident Prisoner Escape
- 3 141335LJAN2004
- 4 Abu Ghurayb Prison, Hard Site
- 5 None
- 6 Personnel involved Prisoner ISN # 12436 and Iraqi Police # 515
- 7 320th MP BN TOC notified of missing prisoner at 1335 hrs. Immediately Hard Site was locked down, swept and headcount of prisoners started. ECP (E), (W) closed, all LSA's secured, and all perimeter towers notified of situation. Additional personnel called to respond to search with K9 teams. Orange jumpsuit was found near tiers 5, 6 and 7 in a porta-john. A footprint was found on top of wall at NE corner of facility next to yellow tower (recently installed). Footprint appeared fresh and is assumed to be from escapee. 372nd notified TOC of missing Iraqi Police from Hard Site at approximately 1415 hrs.
- 8 Further information gathered from 372nd CP showed missing IP and Prisoner were friends and that IP signed missing prisoner out for work detail in tiers 5,6 and 7 of Hard Site at 1150 hrs.
- 9 Publicity None
- 10 Command Reporting 320th MP BN
- 11 POC SSG [REDACTED]
- 12 Downgrading Instructions None

SSG [REDACTED]
320th MP BN
S3, NCOIC
DSN 559-1763

DRV FM 123-2
Dated 24 Feb 98
DECL ON X1

~~Classification SECRET//X1~~

~~Classification SECRET//X1~~

- 1 NA
- 2 Type of incident Prisoner Escape
- 3 141335LJAN2004
- 4 Abu Ghurayb Prison, Hard Site
- 5 None
- 6 Personnel involved Prisoner ISN # 12436 and Iraqi Corrections Officer, ██████████ # 515
- 7 320th MP BN TOC notified of missing prisoner at 1335 hrs. Immediately Hard Site was locked down, swept and headcount of prisoners started. ECP (E), (W) closed, all LSA's secured, and all perimeter towers notified of situation. Additional personnel called to respond to search with K9 teams. Orange jumpsuit was found near tiers 5, 6 and 7 in a porta-john. A footprint was found on top of wall at NE corner of facility next to yellow tower (recently installed). Footprint appeared fresh and is assumed to be from escapee. 372nd notified TOC of missing Iraqi Corrections Officer from Hard Site at approximately 1415 hrs.
- 8 Further information gathered from 372nd CP showed missing Corrections Officer and Prisoner were friends and that Corrections Officer signed missing prisoner out for work detail to clean tiers 5, 6 and 7 of Hard Site at 1150 hrs. Neither individuals have been located at time of report.
- 9 Publicity None
- 10 Command Reporting 320th MP BN
- 11 POC SSG ██████████
- 12 Downgrading Instructions None

PERSONAL DATA REPORT		
GENERAL INFORMATION	PHOTOGRAPH	
Dossier {4F36AA1C-FC00-4B63-A174-8652702B93D1}		
Name (F,M,L) ██████████		
Full Name		
WMD Category		
Operational Status		
Occupation		
National ID # 12436		
Gender MALE		
		ON ALERT / Fals
		THEFT, SENTENCED TO 3 YEARS

Race
 Hair Color
 Eye Color
 Build
 Height (in) Min Max
 Weight (lb) Min Max

PERSONAL DATA

ALIASES

First Name Middle Name Last Name Nickname

PASSPORT INFORMATION

Type Religion Number Issue Date Expiration Date Country Authority

Nationality: IZ-IRAQ

PERSONAL TRAITS

Primary: IZ-IRAQ

LANGUAGE(S)

Ethnicity
 Language Name Language Proficiency Is Native Language

ADDRESSES

Person: Unknown

EMPLOYMENT HISTORY

EPW Status: AT LARGE

MILITARY SERVICE HISTORY

Component: PRISON-3

PHONE NUMBERS

Type Accused Crime Int'l Area Code Phone # Ext

VEHICLE INFORMATION

DNA Sample

RELATIVES

Relation First Middle Last Maiden Birthdate

Had Money

Last Amount

Had Property

Property Description: 160209

Transfer Date

Transfer Location

Release Date

Death Cert #

JITF-CT Classification U S Relationship Status DoD Relationship Status

ALIASES

First Name Middle Name Last Name Nickname

PASSPORT INFORMATION

Type Number Issue Date Expiration Date Country Authority

PERSONAL TRAITS

LANGUAGE(S)

Language Name Language Proficiency Is Native Language

ADDRESSES

EMPLOYMENT HISTORY

MILITARY SERVICE HISTORY

PHONE NUMBERS

Type Int'l Area Code Phone # Ext

VEHICLE INFORMATION

RELATIVES

Relation First Middle Last Maiden Birthdate

SSG [REDACTED]
320th MP BN
S3, NCOIC
DSN 559-1763

DRV FM 123-2
Dated 24 Feb 98
DECL ON X1

Classification, ~~SECRET//X1~~

CIF Detainee Ops 15-6 Accountability of Detainees Recommendations

~~IAW AR 190-8 Military Police, Enemy Prisoners of War, Retained Personnel, Civilian Internees and Other Detainees~~

Chapter 3-3 EPW Facility Management

(1) The United States may subject EPW/RP to internment and may have contingency plans to confine and enclose EPW in camps located both in and outside CONUS. Medical personnel and chaplains classified as RP, while retained by the Detaining Power with a view to assisting prisoners of war, shall not be considered prisoners of war. **The EPW facility commander will provide command, control, accountability, administrative, and logistical support for the operation of all EPW/CI facilities.**

(2) **Establish and maintain complete and accurate accountability information** regarding the location, physical and legal status, training, and employment **of all individuals in the custody of, or assigned to, the EPW facility.** Information will be posted to the individual's personal, medical, and financial records and will be provided to the supporting PWIC and next higher headquarters, as required.

~~IAW 19-95B1-SM, Soldiers Manual, MOS 95B, Military Police, 16 August 2002~~

Task # 191-376-4100

Perform Enemy Prisoner of War/Civilian Internee (EPW/CI) Security and Control Activities at an EPW/CI Camp

Performance Steps

2. Observe security precautions

(1) **Account for captives by number when conducting roll call formations on both an announced and an unannounced basis.** Do this—

(a) **At least twice each day (morning and evening)**

(2) **Immediately following a mass disturbance, the discovery of a tunnel, or the detection of a hole or break in the perimeter fence**

- e Perform random head counts frequently while on work details and when en route to another facility

~~IAW FM 3-19.40, Military Police Internment/Resettlement Operations, 1 August 2001~~

4-2 Enemy Prisoners of War

4-7 The preparation and dispatch of DA Forms 2674-R are governed by AR 190-8, and they are prepared at each internment facility. **Brigade or internment facility commanders may require feeder reports from various compounds to facilitate the preparation of internee strength reports.**

Processing Actions at the EPW Processing Area

Receiving Lines & Records Review

MP Review processed records for completeness and accuracy

Escort CIs back to processing stations to correct errors if necessary

Allow CIs to prepare DA Form 2678-R. If CIs are unable to write their own cards, have someone authorized by the commander to do it for them

Prepare and maintain an accountability roster of all internees

Chapter 4-104 To detect escape attempts, conduct-

Roll Calls and head counts on a regular and unannounced bases.

Roll call twice daily, preferably early morning and late evening.

Head counts immediately after witnessing a mass disturbance, discovering an open tunnel, or detecting a hole or break in a fence

Head counts frequently while on work details and when en route to another facility

~~IAW AR 190-47-The Army Corrections System, 10 August 1998~~

Chapter 11-3 Control procedures

a Strength verification

(1) The facility commander or a designated representative will conduct physical counts of prisoners each day as specified below

Physical counts, at a minimum, will include—

- (a) Roll call, or a similarly accurate accounting method at the morning, noon, and evening formations

(b) Head count immediately on the return of all prisoners from work details.

(c) Bed check between taps and midnight, and again between midnight and reveille.

(2) The installation officer of the day, correctional facility staff duty officer, or military police duty officer will conduct a bed check between midnight and reveille, and at such other times as the installation or facility commander may direct. The reports made by the officer of the day or the military police duty officer to the installation and facility commanders will include the report of verification of the prisoner strength.

using the following procedures. Furthermore, all staff must follow the following procedures for conducting head counts, or bed checks

The senior NCO for each compound/domicile must have the updated detainee strength record/ISN manifest with them to be used during a scheduled or unscheduled count

NOTE Prior to beginning a count the senior NCO for each compound or cell block/domicile must make a note on the detainee strength record/ISN manifest that identifies all detainees that are out of the compound or cell block/domicile that are excused from the count to include the location in which the detainees are, this includes but not limited to detainees that are at scheduled appointments with MI, hospital or at in/outprocessing ect...

The senior compound or cellblock/domicile NCO will direct all detainees to prepare for count

- a. **For detainees that are assigned to a compound,**
 - a. Direct the detainees to form a single line or column adjacent to the holding area adjacent to the compound entrance and prepare to be counted as they enter the holding area
 - b. **For an ISN/Roll Call count (scheduled; Breakfast Meal and 2000hrs daily) (Unscheduled as directed by the, SOG, OIC or I/F commander) - the staff will verify each detainee's ISN on their bracelet against the detainee strength record/ISN manifest and make a check mark next to each detainees name as they enter the holding area**
 - c. If a discrepancy is identified ie (missing detainee), immediately notify the SOG/compound NCOIC of the discrepancy, on order conduct an additional ISN/Roll Call count (All counts must be logged into the compound journal) **Upon completion of any count notify the TOC/CC of the results ie (Compound 3, 455 assigned 455 present) which will be annotated in the TOC/CC journal/blotter as applicable IAW local SOP this may be conducted via radio, phone or messenger Note: Do NOT use names over a radio for OPSEC**

NOTE If any detainees are not present upon completion of any count, notify the TOC/CC of the results identifying each missing detainee by ISN and if known the location of the detainees that were excused from the count this includes but not limited to detainees that are at scheduled appointments with MI, hospital or at in/outprocessing ect .

- d For a Headcount (scheduled at Lunch and Dinner meals) (Unscheduled; after detainees return from outside the compound such as visitation or work detail, after escapes, disturbances, or as directed by the, SOG, OIC or I/F commander) - the staff will physically count each detainee as they enter the holding area and compare it to the total amount identified on the detainee strength record/ISN manifest
- e If a discrepancy is identified ie (missing detainee), immediately notify the SOG/compound NCOIC of the discrepancy, on order conduct an ISN/Roll Call count. (All counts must be logged into the compound journal) Upon completion of any count notify the TOC/CC of the results ie (Compound 3, 455 assigned 455 present) which will be annotated in the TOC/CC journal/blotter as applicable. IAW local SOP this may be conducted via radio, phone or messenger **Note: Do NOT use names over a radio for OPSEC**

NOTE If any detainees are not present upon completion of any count, notify the TOC/CC of the results identifying each missing detainee by ISN and if known the location of the detainees that were excused from the count this includes but not limited to detainees that are at scheduled appointments with MI, hospital or at in/outprocessing ect.

- f **Bed Checks - (Unscheduled head count)** At a minimum the compound staff must conduct a bed check (headcount) once between lights out and midnight and once between midnight and wake up call
- g The bed check will be directed by the TOC/CC and will be unannounced to the detainees This is conducted silently and as unobtrusive as possible by the compound staff
- h The compound staff will walk through the tents using a flashlight to see each detainee verifying that all detainees are present Furthermore, staff must not attempt to wake or agitate the detainees by shining the light in detainees'

eyes. However **staff must see either skin or movement** to verify 100% accountability. The staff will physically count each detainee as they walk through each tent and compare the count to the total amount identified on the detainee strength record/ISN manifest.

- i. This will be logged as an unannounced headcount in the compound journal. If a discrepancy is identified (missing detainee), immediately notify the SOG/compound NCOIC of the discrepancy, on order conduct an ISN/Roll Call count using the above ISN/Roll Call count procedures. Upon completion of any count notify the TOC/CC of the results (Compound 3, 455 assigned 455 present) which will be annotated in the TOC/CC journal/blotter as applicable. IAW local SOP this may be conducted via radio, phone or messenger. **Note: Do NOT use names over a radio for OPSEC.**
- j. Upon being notified by the TOC/CC that the I/F count is cleared staff may resume normal detainee operations.

For detainees that are assigned to a Hard Site (Prison or jail) Cell Block/Domicile,

NOTE: Prior to beginning a count the senior NCO for each cell block/domicile must make a note on the detainee strength record/ISN manifest that identifies all detainees that are out of the cell block/domicile that are excused from the count to include the location in which the detainees are, this includes but not limited to detainees that are at scheduled appointments with MI, hospital or at in/outprocessing ect.

- a. The senior NCO will direct all detainees to prepare for count by standing at the front of their cells to be counted for an ISN/Roll Call count (scheduled, Breakfast Meal and 2000hrs daily) (Unscheduled as directed by the, SOG, OIC or I/F commander).
- b. The domicile staff will carry the detainee strength record/ISN manifest and physically walk by each cell to compare each detainee's bracelet against the strength record/ISN manifest as they verify each detainee is present then make a check mark next to each detainees name if they are present.

- c If a discrepancy is identified ie (missing detainee), immediately notify the SOG/domicile NCOIC of the discrepancy, on order conduct an additional ISN/Roll Call count (All counts must be logged into the cell block/domicile journal) **Upon completion of any count notify the TOC/CC of the results ie: (Cell block 1A, 23 assigned 23 present) and will be annotated in the TOC/CC journal or blotter as applicable IAW local SOP this may be conducted via radio, phone or messenger Note. Do NOT use names over a radio for OPSEC.**

NOTE If any detainees are not present upon completion of any count, notify the TOC/CC of the results identifying each missing detainee by ISN and if known the location of the detainees that were excused from the count this includes but not limited to detainees that are at scheduled appointments with MI, hospital or at in/outprocessing ect...

- d For a Headcount (scheduled at Lunch and Dinner meals) (Unscheduled, after detainees return from outside the compound such as visitation or work detail, after escapes, disturbances, or as directed by the, SOG, OIC or I/F commander) - the staff will physically walk by each cell and count each detainee that is present in their cell and compare it to the total amount identified on the detainee strength record/ISN manifest
- e If a discrepancy is identified ie (missing detainee), immediately notify the SOG/domicile NCOIC of the discrepancy, on order conduct an ISN/Roll Call count (All counts must be logged into the cell block/domicile journal) **Upon completion of any count notify the TOC/CC of the results ie: (Cell block 1A, 23 assigned 23 present) and will be annotated in the TOC/CC journal or blotter as applicable IAW local SOP this may be conducted via radio, phone or messenger Note. Do NOT use names over a radio for OPSEC.**

NOTE If any detainees are not present upon completion of any count, notify the TOC/CC of the results identifying each missing detainee by ISN and if known the location of the detainees that were excused from the count this includes but not limited to detainees that are at scheduled appointments with MI, hospital or at in/outprocessing ect

- f **Bed Checks - (Unscheduled head count)** At a minimum the cell block/domicile staff must conduct a bed check (headcount) once between lights out and midnight and once between midnight and wake up call
- g The bed check will be directed by the TOC/CC and will be unannounced to the detainees. This is conducted silently and as unobtrusive as possible by the cell block/domicile staff
- h The cell block/domicile staff will physically walk by each cell using a flashlight to see inside each cell verifying that all detainees are present. Furthermore, staff must not attempt to wake or agitate the detainees by shining the light in detainees' eyes. However staff must see either skin or movement to verify 100% accountability. The staff will physically count each detainee as they walk by each cell and compare the count to the total amount identified on the detainee strength record/ISN manifest
- i **This will be logged as an unannounced headcount in the cell block/domicile journal.** If a discrepancy is identified ie (missing detainee), immediately notify the SOG/domicile NCOIC of the discrepancy, on order conduct an ISN/Roll Call count (All counts must be logged into the domicile journal) **Upon completion of any count notify the TOC/CC of the results ie (Cell block 1A, 23 assigned 23 present) and will be annotated in the TOC/CC journal or blotter as applicable.** IAW local SOP this may be conducted via radio, phone or messenger. **Note: Do NOT use names over a radio for OPSEC**
- j Upon being notified by the TOC/CC that the I/F count is cleared staff may resume normal detainee operations

NOTE At a minimum the SOG and I/F OIC must conduct a bed check once between lights out and midnight and once between midnight and wake up call. The compound or cell block/domicile staff must accompany the SOG/OIC with a flashlight and staff must see either skin or movement of each detainee. The results of these bed checks will be annotated in the compound or cell block/domicile journal. As directed by the SOG or OIC notify the TOC/CC of the results ie. (Cell block 1A, 23 assigned 23 present) or (Compound 3, 455 assigned 455 present) and will be annotated in the TOC/CC journal or blotter as applicable

On 12 February 2004, a panel of officers, directed by Major General Antonio Taguba, conducted the following interview. Major General Taguba was appointed as an Investigating Officer under the provisions of Army Regulation 15-6, by Lieutenant General David D. McKiernan, Commanding General of the Coalition Forces Land Component Command (CFLCC), to look into allegations of maltreatment of detainees, detainee escapes and accountability lapses, at Abu Gharib, also known as the Baghdad Central Confinement Facility (BCCF). The panel also inquired into training, standards, employment, command policies, and internal policies, concerning the detainees held at Abu Gharib prison. Finally, the panel looked into the command climate and the command and supervisory presence.

The following persons were present:

COL [REDACTED], MP, CFLCC – PMO, **Interviewer**
LTC [REDACTED], SJA, CFLCC – SJA, **Interviewer**
LTC [REDACTED], 705th MP Battalion, **Interviewer**
2LT [REDACTED], 320th MP Battalion, **Respondent**

The interview is summarized as follows:

My full name is [REDACTED]. My social security number is [REDACTED]. My current rank is 2LT, branch, Military Intelligence. I'm currently assigned to the 320th Military Police Battalion, at Baghdad Central Correctional Facility, Abu Gharib Prison near Baghdad, Iraq. I am Army Reservist. I've been assigned to the 320th MP Battalion, since October 2001.

My duty is to brief the Battalion Commander's staff of any potential threats, both inside and outside the facility. At present, I work for LTC [REDACTED]. Before him, I worked for LTC [REDACTED]. I often times seek initial guidance from the acting XO, or S3 Officer, MAJ [REDACTED]. Matters most pressing I take directly to the Battalion Commander. Up until recently, the XO was MAJ Michael [REDACTED]. He re-deployed.

I'm the primary liaison officer with the tactical HUMINT team we have on the ground, and, from time to time, I talk with other personnel in the 504th, which replaced the 202nd MI Brigade, and the 202nd MI Battalion, which replaced 165th MI Battalion. So, I've worked with all 3, in addition to another MI Company, that was initially on the ground.

Any other reports would be coming down from higher headquarters, through our Brigade, that were possibly created from the other tenant MI units at Baghdad Correction Facility. I communicate with the 16th MP Brigade S2 daily. With the 800th MP Brigade, I communicated with CPT [REDACTED], the S2 Officer, at least, daily. They were located at Camp Victory. Their visits varied. Sometimes, they would come to see our facilities, only once or twice a month. Other times it would be a couple times a week.

The 372nd MP Company was the unit that provided the soldiers, to control the prisoners, and to coordinate with the Iraqi Corrections Officers.

I'm not certain, whether or not it was directly connected to the prison, but the MI had the interrogation centers, and the place where they conducted most of their administrative analysis work was in the same vicinity as the hard site prison. The population was mostly under the control of the MPs.

I've heard that any alterations that they have from the standard rules of engagement, what the MI does, when they have prisoners in their custody, if they need to interrogate them, or put pressure on them, it needs to be authorized in writing. I don't know if those documents are on file.

I think the CPA would be the final over-arching authority. As soon as we started taking prisoners, it was known as a CPA prison. On the U.S. Military side, 372nd MP Company is in charge of the hard site. They report to the Battalion Commander of the 320th MP Battalion.

I had daily interaction with LTC [REDACTED]. When I reported Intel to him, he would first check the source for credibility. Then, he would take appropriate action, such as notifying tower positions, entry control point positions, QRF, IRF, and have them prepared to react.

The primary threat was we didn't have enough MPs to adequately guard the population that we had. We were well over capacity, since November 22nd. What the presiding commander did to mitigate that threat was work with our S3, who does the Task Organization, to break down the companies, and allocate resources from other places, such as from non-MOS qualified personnel, to help fill in and do some of the compound guard duties that didn't require MP-specific training, while MPs in the compound were doing MP-specific duties.

We've captured many smuggled notes, and weapons, mostly knives or cooking utensils, and on one occasion a pistol was smuggled into the CPA prison in with the food, and it actually got into an detainee's hands, and he actually fired it on an MP. Other firearms and weapons could always potentially come in, because of the number of food contractors were coming in.

I did attend the daily staff briefing.

The MI would coordinate with the Military Police or Iraqi Corrections Officers, if they were going to be working in the area, so they would be aware of their presence. I believe the MI escorted the inmates to the interrogation cells. Realizing I wasn't getting the support, that I should have, doctrinally, I took initiative, and got that information from the THT. For some time now, I was providing some of the personnel that were working with and on the THT.

My promotion is 2 months late, Sir. Our S1 is doing all she can to support that

I believe we had a briefing on the Geneva Convention, Sir. Everyone should be aware of it. It would be a good idea to have more of that at the facility

I am aware, to some extent, of the allegations of detainee abuse. I heard that there were some soldiers, possibly in the 372nd MP Company, that were forcing detainees to do things of a lewd or sexual nature, while photographing or video taping it. It sounds like these were soldiers, who don't have a good head on them. They don't know what's right from wrong. I don't think it's a leadership failure, or a broken chain of command. Our Battalion Commander is one of the few people that held our unit together, through some very difficult, overwhelming, and seemingly impossible parts of the mission, that we've had over the last year. I think there are just a couple sick soldiers out there, that made some very poor and stupid decisions, and now some people that had nothing to do with it have to pay for it.

I received my commission through ROTC, Sir. Penn State, Sir

Finished with their discussion, the panel gave 2LT [REDACTED] a list of items, to be addressed, and brought back on a Sworn Statement



**HEADQUARTERS
COMBINED JOINT TASK FORCE SEVEN
BAGHDAD, IRAQ
APO AE 09093**

1
1
CJTF-CC

17 January 2004

MEMORANDUM FOR BG JANIS KARPINSKI, 800th Military Police Brigade, Camp Victory, Iraq

SUBJECT: Memorandum of Admonishment

1. The 800th Military Police Brigade continues to perform in a manner that does not meet the standards set by the Army or by CJTF-7. In the past 6 months, incidents have occurred that reflect a lack of clear standards, proficiency and leadership within the Brigade. As the commander, I hold you ultimately responsible for these deficiencies.
2. The reported detainee abuse incident at the Baghdad Correctional Facility (Abu Ghraib) is the most recent example of what I am increasingly concluding is a poor leadership climate that permeates the Brigade. As an immediate step, as the senior commander in Iraq, I am directing the suspension of the platoon leader, company commander and battalion commander of the units involved in the incident at Baghdad Correctional Facility. You will assess their fitness to occupy leadership positions and report the results of your assessment to Major General Wojdakowski no later than 23 January 2004.
3. I admonish you to take charge of the Brigade and take the corrective actions necessary to set and enforce standards. To that end, I have requested that the Commander, U.S. Central Command, provide a team of experts to conduct focused training on confinement operations, with specific emphasis on the requirement to treat all persons under Coalition Forces' control with dignity and respect.

// ORIGINAL SIGNED //
RICARDO S. SANCHEZ
Lieutenant General USA
Commanding

CU
MGR Wojdakowski

On 11 February 2004, a team of officers, directed by Major General Antonio Taguba, conducted the following interview. Major General Taguba was appointed as an Investigating Officer under the provisions of Army Regulation 15-6, by Lieutenant General David D. McKiernan, Commanding General of the Coalition Forces Land Component Command (CFLCC), to look into allegations of maltreatment of detainees, detainee escapes and accountability lapses, at Abu Ghraib, also known as the Baghdad Central Confinement Facility (BCCF). The panel also inquired into training, standards, employment, command policies, and internal policies, concerning the detainees held at Abu Ghraib prison. Finally, the panel looked into the command climate and the command and supervisory presence.

The following persons were present:

MG Antonio M. Taguba, 576-50-8375, DCG-CFLCC, **Interviewer**
COL [REDACTED], **Member**
CPT [REDACTED], **Member**
SFC [REDACTED], **Member**
SGT [REDACTED], 372nd MP Company, **Interviewee**
SSG [REDACTED], 27D30, CFLCC - SJA, **Recorder**

The interview is summarized as follows:

My name is [REDACTED]. I am a Sergeant/E-5. My social security number is [REDACTED]. I am assigned to the 372nd MP Company.

I was assigned to the 372nd MP Company in November 2002. I was involuntarily transferred from the MMC at Fort Belvoir, VA. My MOS is a military police and my secondary MOS is 92A Logistic Specialist. I was on Active Duty from 1975 to 1981 as a military police officer. We mobilized out of Fort Lee, VA. We stayed three months at Fort Lee, VA.

Prior to deploying we trained on basic soldier skills, and we did MOUT training at Fort Stewart, GA. Our platoon, 4th Platoon did some additional training and I personally took some additional training. Our company was a combat support unit. We didn't receive any training in regards to being a guard company.

We arrived in country in April of 2003. Our company commander was CPT [REDACTED], our platoon leader was CPT [REDACTED], and our platoon sergeant was SFC [REDACTED]. My squad leader was SSG [REDACTED] until he went home in December.

Our first mission was to pull force protection at Camp Arifjan. We then moved to Al Hila, Iraq and performed an LNO/training mission for three months. In Al Hila we worked out of a warehouse. There we interfaced with both the court system and the local law enforcement personnel. We worked with them as far as weapons safety, and we came in direct contact with detainees. We didn't receive training as far as corrections, a lot of us used our civilian background as a standard on how we treated the detainees.

We didn't receive any training on the Geneva Conventions while working with the Iraqi law enforcement. To my knowledge the detainees at the facilities we trained at were not under the Geneva Convention because it was Iraqi on Iraqi crime at their local facility, so Iraqi laws governed them. We ensured that they were handled humanely and that they got to trial in due time. This is only my statement on what I understood what the detainee status was, I can't speak for the company.

In June we received a PSD mission at Al Hila. After that mission we returned back to the warehouse to finish the LNO mission. Next, we received orders to return back to Arifjan to conduct inventory and clean vehicles. Then, around October we moved to Abu Graib.

We were briefed that we would be doing Force Protection, escorting, and some corrections EPW type work. We were told that we would be assisting Iraqi Corrections Officers at the corrections facility, with one wing being solely dedicated for MI use. The wing was Tier 1. I was assigned to Tier 2 upon my arrival at the facility. I was then assigned to Tier 1 as a relief officer.

While on duty in Tier 1 I was shoot at by one of the inmates, which resulted in a large investigation. The investigation determined that there was staff bringing weapons in to the inmates. The incident took place on Thanksgiving Eve, the 23rd of November. Inmate #151365 informed me that there was an inmate in Tier 1 had a weapon and two knives.

The weapon was located on the Alpha side, I worked the Alpha side and SPC Ambiaul worked the Bravo side. I had a translator talk to the inmate, and then I determined that I had an issue and contacted the NCOIC, SOG, COL [REDACTED] and the medics. We formulated a plan based on ROE and tried to get the inmate to come out. The inmate refused and started to fire his weapon, with one of the rounds hitting my vest. We ended up wounding the inmate and flying him out to medical attention.

The 800th ROE SOP was the rules that we followed. This SOP outlined the compound rules of engagement, but it changed after the incident. There were not a set number of U.S. personnel per Tier. There were guard mounts performed prior to shift changes, but they didn't occur daily. The NCOIC of the compound would hold the guards.

I have the 1600 to 0400 guard shifts. SPC [REDACTED] and myself were the only personnel on duty at the time of the shooting incident. When we received the tip we informed the staff, and then we identified who the inmate was with our records. COL [REDACTED] SSG [REDACTED] SSG [REDACTED] SSG [REDACTED], SPC [REDACTED] some MI staff, and the medics were all present when I was talking to the inmate about him having a weapon in the cell. I was trying to get the inmate to come out of the cell so we could get cuffs on him, but he did not comply.

My understanding is that CPA cleared the staff that worked at the compound. The Tier was under control by U.S. personnel, but Iraqis worked at the access control point for that Tier. One of the Iraqis at the access control point provided the inmate with the weapon.

When I tried to grasp the inmate's risk but he pulled away from me. The inmate got down and stated praying at that point I knew it would be a gun battle. He moved closer to the bed and started to reach under the pillow. He pulled the weapon from the pillow and then he fired. He repeatedly fired the weapon when SSG [REDACTED] shot him in the chest with two non-lethal rounds. The inmate fell down and quickly got back up. SSG [REDACTED] told the inmate to put the weapon down, but the inmate did not do it. SSG [REDACTED] fired in into the cell a wounded the inmate. The inmate did not give up until he ran out of rounds, not because he was wounded. We secured the inmate to the door. we patted him down, and we got him to the medics for treatment.

I continued to work relief for Tier 1, and then when SPC [REDACTED] left I took more of a primary role. [REDACTED] usually worked the Tier 1, but he was off the night of the incident. I never worked with [REDACTED] just relieved him. SSG [REDACTED] would tell me when I would relieve [REDACTED] there was never a roster.

The [REDACTED] usually know the personnel who work Tier 1. I have asked the MI section for guidance to Access Roster of Tier 1. I know the reason why the inmates are held in Tier 1. I know they are MI inmates because I get a number, and I receive special instruction and if I don't I ask. The people in civilian clothes are OJA staff, FBI, and CID. I can't remember any names but I know descriptions. I don't specifically know Stefonovich and Israel. I probably would recognize them.

The people that come into the Tier must have a need to know in order to enter the Tier. I would usually recognize the MI staff, my concerns were with the civilian agencies because there were so many. We had an access form that required all of the person's pertinent info before they entered the Tier.

After interrogation the detainees were given back to us for custody. I never accompanied them to the interrogation site. When the detainees were returned we were not given any special instructions. If anyone had asked, I would have told him or her to put it in writing.

I have never treated any detainees in an ill or degrading way. With my background in corrections I believe that detainees need to be in a safe environment, receive medical treatment, they need to be fed, and they need protection. I have detainees that make request regarding Geneva Conventions all the time. I take the request to the NCOIC. The request does not have my name on it. I just pass the request on to the proper individual.

My first knowledge of the allegations was when the investigation was started. I had no prior knowledge of detainee abuse. I was on duty when an incident occurred, but I did not witness anything.

I don't remember a [REDACTED] asking me if an inmate had been struck, because that is not the way I operate. I understand that the limit of isolation was that an inmate could be in isolation for up to 30 days. I heard that a General passed that rule, but I don't know which General. I did confirm the time limit with [REDACTED] and he acknowledged that to be true. When an inmate is in isolation, you would perform random, but frequent checks on the inmate throughout the night, and you would make sure that they would not be trying to escape. The trans-interrogation physician does make periodic checks also. There was no special meal plan, they would eat MRE's then it was changed to Iraqi food.

I currently perform guard duty in Tier 1A. My hours are from 1600 to 0400; I currently pull duty with SGT [REDACTED] and SPC [REDACTED]. There are random checks made on us during our shift. We had random checks before the investigation also. I believe some officers have been through during my shift, particularly CPT [REDACTED].

I don't appreciate people making false complaints against me. I would probably have to work on remembering who is in and out of the facility.

The panel briefed SGT [REDACTED], and then he was dismissed.

On 10 February 2004, a panel of officers, directed by Major General Antonio Taguba, conducted the following interview. Major General Taguba was appointed as an Investigating Officer under the provisions of Army Regulation 15-6, by Lieutenant General David D. McKiernan, Commanding General of the Coalition Forces Land Component Command (CFLCC), to look into allegations of maltreatment of detainees, detainee escapes and accountability lapses, at Abu Gharib, also known as the Baghdad Central Confinement Facility (BCCF). The panel also inquired into training, standards, employment, command policies, and internal policies, concerning the detainees held at Abu Gharib prison. Finally, the panel looked into the command climate and the command and supervisory presence.

The following persons were present:

COL [REDACTED] MP, CFLCC – PMO, **Interviewer**
LTC [REDACTED] JA, CFLCC – SJA, **Interviewer**
LTC [REDACTED] 705th MP Battalion, **Interviewer**
1LT [REDACTED] 870th MP Company, **Respondent**

The interview is summarized as follows:

It's First Lieutenant [REDACTED] I'm the Company Commander at the 870th Military Police Company. We are located at Abu Gharib Prison. Right now, the 870th has the ECPs, Ganci Compounds 6, 7, and 8, we also have the holding and processing center. We work for the 320th MP Battalion. We haven't had any problems, so far.

There are a lot of problems between the MI and the MPs. The present feeling in the compound is – there is a lot of MI soldiers on the base, but the MPs do all of the work. In October the 870th moved into the LSA, when nobody was living there. We cleaned it up, painted it, and built everything on our own. The MI moved in, afterwards, have taken over the entire LSA, and squeezed us down to nothing. So, there's a lot of animosity between the MP soldiers and the MI. The MI is not doing any force protection. There's more of them but they're not doing anything. It's very little MPs on the entire base but yet they're pulling all of the missions. And that's what I have to contend with.

Right before LTC [REDACTED] left, I know we had a good relationship with one of MI LTCs. LTC [REDACTED] prior to him leaving, actually got me some MI soldiers and some LRS soldiers, to come down and help at the ECPs, and take over some of the towers cause my company was stretched pretty tight. We're at a good level, but because of REFRADs, we need a lot more, and I'll have to bring it up to LTC Upshaw and the 3. We're getting stretched pretty thin, again.

I never really had any contact with Gen Karpinski other than one time she came to visit, I think it was Christmas and I escorted her to my compounds and I was responsible for her. That was the only engagement between Gen Karpinski and myself. LTC Phillabaum? I sat down with him a few times in regards to having "hajji" barbers in the LSA, in a little

PX set up. He didn't want them in there. That was my only dealing with him. Eventually, COL Pappas ordered them all off, and they went back to Karbala.

We did get SOPs, when we initially got there, from the 320th. And I personally wrote the one for the ECP, and my other officers updated and wrote the one for the holding area and inprocessing center, but we did initially get an SOP from the 320th and we updated it. To my understanding, the SOP was still in the works. For the areas of responsibility we had, we took that part of the SOP, and we incorporated it and re-wrote it and made it to a working standard.

Prior to deploying in January, we had our summer camp in preparation for this. It was a two-week training class in the field in regards to guard operations, EPWs, convoy security, we also had a second AT in February, the same amount of training. When we got to Fort Lewis, we were activated in March, we set up and had another training scenario the same way for about 3 weeks with the 91st Training Division, EPW handling, convoy security, riots and civil disturbances, it was all entailed in that, Sir.

Initially, the training we received at Fort Lewis and Camp Roberts was training for what we're doing now. It didn't seem to come into focus until we got assigned to the 320th, because prior to that we were doing LNOs. I remember we received training on Geneva Conventions out of Fort Lewis but I don't remember exactly what it was.

Initially, we were tasked at a rating of 98 MPS for MP missions. At the time, I think we had 74 active MPs. Prior to us deploying, like myself I'm a volunteer to come over with this unit. I'm not an MP I'm Calvary. We had some 11Bs assigned to this unit along with other MOSSs to fill in for this unit to be deployed. We all received the same training that the MPs did in January, February, and March prior to being deployed. Because of our taskings, we've filled them with everyone. We had cooks, infantry, you name it they're all out there working the shifts.

Besides the initial training we had for those three different time periods, prior to our deploying, they received on the job training, and training from senior MPs, former law enforcement officers, or current law enforcement.

One of my soldiers was involved in a shooting, during an escape attempt, and there is an investigation in regards to that. I understand, yes, there may have been some abuse with one of the units and some prisoners. I don't know the details. I try to stay out of their business.

When I dealt with him, with regards to incidents, especially the shooting when we had an escape, I dealt with him one on one, in regards to procedures and policies, prior to that, no.

Actually, we had 3 disciplinary actions that I took to him and he actually dealt with them personally. He did the Article 15s, he came down to our area, read the person their

rights, talked to them and did the whole process. Anytime I went to him with a problem or already talked to him, he dealt with it.

What we have posted down in my compound are Rules of Engagement, Special Orders and the SOP. They are kept in the TOC, each tower, and each one of my soldiers has the Rules of Engagement on their person, in their helmets. They've carried them from day one.

Now, when we got a copy of CJTF7 we switched from Marines Rules of Engagement. It's a little different, Sir. The Marine Corps is a little more aggressive.

Finished with their discussion, the panel gave 1LT [REDACTED] a list of items to be addressed, and brought back on a Sworn Statement.



DEPARTMENT OF DEFENSE
OFFICE OF FREEDOM OF INFORMATION AND SECURITY REVIEW
1155 DEFENSE PENTAGON
WASHINGTON, DC 20301-1155

Ref: 04-F-2296

NOV 08 2004

Mr. John Greenewald, Jr.

Dear Mr. Greenewald:

This is in response to your April 30, 2004, Freedom of Information Act (FOIA) request. In your request you asked for "all documents pertaining to the mistreatment of Iraqii (sic) Prisoners of War and other personnel" by the U.S. military. Because the information you requested is currently a matter of litigation between the American Civil Liberties Union and the Department of Defense in the U.S. District Court for the District of Southern New York, documents will be released to you as they are released through court action. Enclosed is the AR 15-6 Investigation of the 800th Military Police Brigade, Major General Antonio M. Taguba, Investigating Officer, otherwise referred to as The Taguba Report. Annexes to the report numbered 25, 26, 34, 40, 97, 103 and 104 are not included as they have not yet been cleared for release.

Under the FOIA, 5 U.S.C. § 552, U.S. Government agencies must make available to the public all information that is not specifically exempted from disclosure. Portions of the Taguba Report have been withheld from the plaintiff in the aforementioned litigation under the following FOIA exemptions.

5 USC§552 (b) (1) which applies to information which is currently and properly classified pursuant to Executive Order 12958, as amended. In this instance the denied information is currently and properly classified pursuant to Section 1.4(c) of the Executive Order in that the information concerns intelligence activities, intelligence sources or methods.

5USC§552 (b) (2) (High), which applies to information whose release would result in the circumvention of a Department of Defense (DoD) rule, policy, or statute, thereby impeding the DoD in the conduct of its mission.

5 USC§552 (b) (3), which pertains to information exempt from release by statute. The relevant statutes in this instance are 10 USC§130b and 10 USC§130c. 10 USC§130b authorizes the Secretary of Defense to withhold from disclosure personally identifying information concerning personnel in overseas, sensitive, or routinely deployable units 10 USC§130c allows for the withholding of certain sensitive information of foreign governments and international organizations.



5 USC§552 (b) (5), which protects information of a predecisional and deliberative nature which, if released could reasonably be expected to interfere with the government's deliberative process.

5 USC§552(b) (6) which pertains to information the release of which would constitute a clearly unwarranted invasion of personal privacy.

Because of the ongoing litigation, FOIA administrative appeal rights for these documents are deemed moot. Should any of the withheld information be released through this court action, it will be forwarded to you.

There are no assessable fees for this response in this instance.

Sincerely,

C.Y. Talbott
Chief

Enclosure:
As stated