

THIS FILE IS MADE AVAILABLE THROUGH THE DECLASSIFICATION EFFORTS AND RESEARCH OF:

# THE BLACK VAULT

THE BLACK VAULT IS THE LARGEST ONLINE FREEDOM OF INFORMATION ACT / GOVERNMENT RECORD CLEARING HOUSE IN THE WORLD. THE RESEARCH EFFORTS HERE ARE RESPONSIBLE FOR THE DECLASSIFICATION OF THOUSANDS OF DOCUMENTS THROUGHOUT THE U.S. GOVERNMENT, AND ALL CAN BE DOWNLOADED BY VISITING:

[HTTP://WWW.BLACKVAULT.COM](http://www.blackvault.com)

YOU ARE ENCOURAGED TO FORWARD THIS DOCUMENT TO YOUR FRIENDS, BUT PLEASE KEEP THIS IDENTIFYING IMAGE AT THE TOP OF THE .PDF SO OTHERS CAN DOWNLOAD MORE!

**JNCLASSIFIED**

**DST-1160G-514-81-VOL 1**

W/Chg2

w/chg3

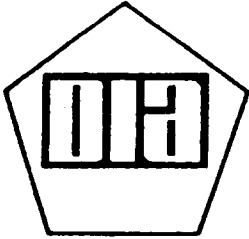

**DEFENSE  
INTELLIGENCE  
AGENCY**

**SMALL-CALIBER  
AMMUNITION  
IDENTIFICATION GUIDE (U)  
VOLUME 1  
SMALL-ARMS CARTRIDGES  
UP TO 15 mm (U)**

**LAST COPY  
RETURN TO FILE**

**20 AUGUST 1984**

**APPROVED FOR PUBLIC RELEASE;  
DISTRIBUTION UNLIMITED**

**UNCLASSIFIED**

DST-1160G-514-81-VOL 1-CHG 3  
16 August 1991

VALIDATION STATEMENT

SMALL-CALIBER AMMUNITION IDENTIFICATION GUIDE  
VOLUME 1: SMALL-ARMS CARTRIDGES UP TO 15 MM

DST-1160G-514-81-VOL 1

11 September 1981

DIA TASK UNIT PT-1160-01-07L

EFFECTIVE DATE OF REVIEW  
30 May 1991

The data upon which this document is based have been subjected to a continuous review and analysis by the US Army Foreign Science and Technology Center, and it has been determined that the substantive content of this document is still valid and up-to-date as of May 1991.

NOTE: The subject matter covered in this product is continuously being review for currency and accuracy by the Infantry Branch, US Army Foreign Science and Technology Center. Communications may be established by contacting Commander, US Army Foreign Science and Technology Center, 220 Seventh Street, NE., Charlottesville, VA 22901-5396, ATTN: AIFRCB, or calling AUTOVON 274-7475.

This validation constitutes change 3 to the basic publication.

This is a Department of Defense Intelligence Document prepared by the Foreign Science and Technology Center, US Army Intelligence Agency, and approved by the Directorate for Scientific and Technical Intelligence of the Defense Intelligence Agency.

APPROVED FOR PUBLIC RELEASE;  
DISTRIBUTION UNLIMITED

SMALL-CALIBER AMMUNITION IDENTIFICATION GUIDE (U)

Volume 1  
Small-Arms Cartridges Up to 15 mm (U)

AUTHOR  
Albert Watson, III

DST-1160G-514-81-VOL 1-CHG 2

DIA TASK UNIT PT-1160-01-07L

DATE OF PUBLICATION  
29 May 1987

Information Cutoff Date  
4 March 1987

This publication, with Changes 1 and 2, supersedes  
DST-1160G-514-78-VOL 1, dated June 1978.

This is a Department of Defense  
Intelligence Document prepared  
by the Foreign Science and Tech-  
nology Center, US Army Intel-  
ligence Agency, under the DOD  
S&T intelligence production  
program and approved by the  
Assistant Chief of Staff for  
Intelligence, US Army.

This document has been processed for CIRC.

APPROVED FOR PUBLIC RELEASE;  
DISTRIBUTION UNLIMITED

(Reverse Blank)



DST-1160G-514-81-VOL 1-CHG 2  
29 May 1987

Publication No.  
DST-1160G-514-81- US ARMY INTELLIGENCE AGENCY  
VOL 1 FOREIGN SCIENCE AND TECHNOLOGY CENTER  
CHANGE 2 Charlottesville, VA 22901-5396

SMALL-CALIBER AMMUNITION  
IDENTIFICATION GUIDE (U)

Volume 1  
Small-Arms Cartridges Up to 15 mm (U)

Publication No. DST-1160G-514-81-VOL 1, dated 11 September 1981, and amended as Change 1 on 20 August 1984, is amended for Change 2 as follows: The pages listed below are to be removed and destroyed in accordance with existing security regulations and new pages substituted or added as indicated.

Remove pages:	Insert new pages:
Title page	Title page
iii thru vi	iii thru vi
11 and 12	11 and 12
----	36.1 (Reverse Blank)
37 and 38	37 and 38
65 thru 68.2	65 thru 68.2
73 thru 78	73 thru 78
97 and 98	97 and 98
125 and 126	125 and 126
128.1 thru 130	128.1 thru 130
177 (Reverse Blank)	177 (Reverse Blank)
199 (Reverse Blank)	199 (Reverse Blank)
203 thru 207 (Reverse Blank)	203 thru 207 (Reverse Blank)

In addition, make the following pen-and-ink changes in list of tables:

- a. Page xvi: for table xxiv, change page number from 125 to 126.
- b. Page xvi: for table xxv, change page number from 128 to 128.2.

(Reverse Blank)

DST-1160G-514-81-VOL 1-CHG 1  
20 August 1984

Publication No. US ARMY MATERIEL  
DST-1160G-514-81- DEVELOPMENT AND READINESS COMMAND  
VOL 1 FOREIGN SCIENCE AND TECHNOLOGY CENTER  
CHANGE 1 Charlottesville, VA 22901

SMALL-CALIBER AMMUNITION  
IDENTIFICATION GUIDE (U)

Volume 1

Small-Arms Cartridges Up to 15 mm (U)

Publication No. DST-1160G-514-81-VOL 1, dated 11 September 1981, is amended as follows: The pages listed below are to be removed and destroyed in accordance with existing security regulations and new pages are substituted or added.

Remove pages:	Insert new pages:
Front cover/back cover Title page iii thru v (Reverse Blank) 39 thru 42 45 thru 50  67 and 68  125 thru 128 133 and 134  149 and 150 167 and 168 175 and 176 181 thru 184 189 thru 207 (Reverse Blank)	Front cover/back cover Title page iii thru vi  39 thru 42.4 45 thru 50.5 (Reverse Blank) 67 thru 68.1 (Reverse Blank) 125 thru 128.2 133 thru 134.1 (Reverse Blank) 149 and 150 167 and 168 175 and 176 181 thru 184 189 thru 207 (Reverse Blank)

(Reverse Blank)

## PREFACE

This guide outlines a systematic procedure for identifying military cartridges as to cartridge designation, country of manufacture, and--to a large extent--functional bullet type. Designed for use by persons who may not be familiar with small-arms ammunition, it provides basic information on cartridge types, construction, and terminology as well as more detailed identification data.

This guide covers military cartridges in calibers of 15 mm and below--as well as several related paramilitary or target cartridges--that have been manufactured or used since 1930. Although some of the cartridges in this guide are obsolete in the country of manufacture, they are included because they were made in such large quantities that examples may still be found. To keep the size of the guide within manageable limits, it does not include experimental or caseless types, blank cartridges, cartridges for propellant-actuated devices, ignition cartridges, or sporting cartridges. Detailed information on small arms using many of these cartridges may be found in two companion volumes: SMALL-ARMS IDENTIFICATION AND OPERATION GUIDE--EURASIAN COMMUNIST COUNTRIES, DST-1110H-394-76, and SMALL-ARMS IDENTIFICATION AND OPERATION GUIDE--FREE WORLD, DST-1110H-163-76, with changes.

The information contained in this guide has been derived from examination of cartridges, intelligence reports, US and foreign technical publications, and contributions from individuals.

Important new or revised information incorporated in Change 1 or 2 is indicated by an asterisk (\*).

DST-1160G-514-81-VOL 1-CHG 2  
29 May 1987

Most illustrations appearing in this document are identified by a six-digit negative number printed in the lower left corner of the figure. Users can request prints of these illustrations by citing the negative numbers and the short title of this study in a request addressed to the Commander, US Army Foreign Science and Technology Center, 220 Seventh Street, NE., Charlottesville, VA 22901-5396 (ATTN: AIFPO).

Constructive criticisms, comments, and suggested changes are encouraged and should be forwarded to the Commander, US Army Foreign Science and Technology Center, at the above address.

LIST OF EFFECTIVE PAGES

SUBJECT MATTER	PAGE NUMBERS	DATE
Title Page .....	None	29 May 87
Preface .....	iii and iv	29 May 87
List of Effective Pages .....	v and vi	29 May 87
Record of Changes .....	vii (Reverse Blank)	11 Sep 81
Table of Contents .....	ix thru xi (Reverse Blank)	11 Sep 81
List of Illustrations ..	xiii and xiv	11 Sep 81
List of Tables .....	xv and xvi	11 Sep 81
Section I .....	1 thru 16	-----
	1 thru 10	11 Sep 81
	11 and 12	29 May 87
	13 thru 16	11 Sep 81
Section II .....	17 thru 22	11 Sep 81
Section III .....	23 thru 68.2	-----
	23 thru 36	11 Sep 81
	36.1 thru 38	29 May 87
	39 thru 42.4	20 Aug 84
	43 and 44	11 Sep 81
	45 thru 50.5	20 Aug 84
	(Reverse Blank)	
	51 thru 64	11 Sep 81
	65 thru 68.2	29 May 87
Section IV .....	69 thru 134.1	-----
	(Reverse Blank)	
	69 thru 72	11 Sep 81
	73 thru 78	29 May 87
	79 thru 96	11 Sep 81
	97 and 98	29 May 87
	99 thru 124	11 Sep 81
	125 and 126	29 May 87
	127 and 128	20 Aug 84
	128.1 thru 130	29 May 87

SUBJECT MATTER	PAGE NUMBERS	DATE
	131 and 132	11 Sep 81
	133 and 134.1 (Reverse Blank)	20 Aug 84
Appendix I (para 1 and 2) .....	135 and 136	11 Sep 81
Annex A .....	137 thru 177 (Reverse Blank)	-----
	137 thru 148	11 Sep 81
	149 and 150	20 Aug 84
	151 thru 166	11 Sep 81
	167 and 168	20 Aug 84
	169 thru 174	11 Sep 81
	175 and 176	20 Aug 84
	177 (Reverse Blank)	29 May 87
Annex B .....	179 thru 184	-----
	179 and 180	11 Sep 81
	181 thru 184	20 Aug 84
Annex C .....	185 thru 189 (Reverse Blank)	-----
	185 thru 188	11 Sep 81
	189 (Reverse Blank)	20 Aug 84
Annex D .....	191 thru 199 (Reverse Blank)	-----
	191 thru 198	20 Aug 84
	199 (Reverse Blank)	29 May 87
Appendix II .....	201 and 202	20 Aug 84
Bibliography .....	203 (Reverse Blank)	29 May 87
Distribution List .....	205 thru 207 (Reverse Blank)	29 May 87

RECORD OF CHANGES

CHANGE NUMBER	DATE OF CHANGE	DATE ENTERED	SIGNATURE, RANK/RATE AND ORGANIZATION OF INDIVIDUAL ENTERING CHANGE

TABLE OF CONTENTS

	<u>Page</u>
Preface .....	iii
SECTION I. INTRODUCTION	
1. General .....	1
2. Organization .....	2
3. Cartridge Cases .....	3
4. Bullets .....	8
5. Cartridge Designation .....	10
6. Headstamp Markings .....	11
7. Functional Type Markings .....	16
SECTION II. CARTRIDGE IDENTIFICATION PROCEDURES	
1. General .....	17
2. Caliber and Cartridge Designation ...	17
3. Country and Year of Manufacture .....	20
4. Functional Type .....	20
5. Box and Package Markings .....	21
SECTION III. CARTRIDGE IDENTIFICATION DATA	
1. Cartridge Case Outline Drawings .....	23
2. Dimensional Data .....	37
3. Cartridge Reference Data .....	38
SECTION IV. MARKING PRACTICES BY COUNTRY	
A. GENERAL	
1. Scope .....	69
2. Organization .....	69



TABLE OF CONTENTS (Continued)

	<u>Page</u>
<b>B. COUNTRY MARKING PRACTICES</b>	
3. Argentina .....	69
4. Australia .....	71
5. Belgium .....	72
6. Bulgaria .....	72
7. Canada .....	73
8. China .....	73
9. Czechoslovakia .....	78
10. Denmark .....	80
11. East Germany .....	80
12. Egypt .....	80
13. Finland .....	86
14. France .....	87
15. Germany .....	94
16. Hungary .....	94
17. India .....	96
18. Iran .....	96
19. Israel .....	97
20. Italy .....	98
21. Japan .....	101
22. Lebanon .....	103
23. Netherlands .....	103
24. North Korea .....	104
25. Norway .....	105
26. Poland .....	106
27. Portugal .....	109
28. Taiwan .....	109
29. Republic of South Africa .....	109
30. Romania .....	110
31. Saudi Arabia .....	111
32. South Korea .....	112
33. Spain .....	113
34. Sweden .....	114
35. Switzerland .....	117
36. Syria .....	118

TABLE OF CONTENTS (Continued)

	<u>Page</u>
37. Turkey .....	119
38. United Kingdom .....	120
39. United States .....	124
40. USSR .....	126
41. World War II--Germany .....	130
42. Yugoslavia .....	134
APPENDIX I. Cartridge Headstamp Identification Guide .....	 135
Annex A. Cartridge Headstamps Containing Roman Alphabet Letters .....	 137
Annex B. Cartridge Headstamps Containing Non-Roman Alphabet Letters or Numerals .....	 179
Annex C. Cartridge Headstamps Containing Oriental Characters or Miscellaneous Symbols as a Major Element .....	 185
Annex D. Cartridge Headstamps Containing Western Numerals Only, or Having Factory Code Numbers as a Major Element .....	 191
APPENDIX II. Obsolete Military Cartridges ....	201
Bibliography .....	203
Distribution List .....	205

LIST OF ILLUSTRATIONS

<u>Figure</u>	<u>Page</u>
1. Small-Arms Cartridge Primers .....	4
2. Rimmed Cartridge Case .....	5
3. Semirimmed Cartridge Case .....	5
4. Identifying a Semirimmed Cartridge Case .....	6
5. Rimless Cartridge Case .....	6
6. Rebated Cartridge Case .....	7
7. Belted Cartridge Case .....	7
8. Typical Bullet Shapes .....	8
9. Single-Element Headstamp .....	13
10. Two-Element Headstamps .....	13
11. Three-Element Headstamps .....	14
12. Four-Element Headstamp .....	14
13. Five-Element Headstamp .....	15
14. Headstamps With Segment Lines .....	15
15. Tracer Cartridge With Bullet Tip and Primer Annulus Color Identification ....	16
16. Measuring Cartridge Case Length With a Vernier Caliper .....	17
17. Example of Proper Fit Between Cartridge Case and Outline Drawing .....	18
18. Example of Improper Fit Between Cartridge Case and Outline Drawings ....	19
19. Location of Rim and Head Measurements ...	19
20. Bulgarian Sheet-Metal Container Markings, 7.62x39 Ball Cartridges, Type PS .....	73
21. Chinese Sheet-Metal Container Markings, 12.7x108 API-T, Type 54 Cartridges .....	74
22. Czechoslovak Sheet-Metal Container Markings, 7.62x39 Ball Cartridges in Clips .....	79
23. Egyptian Label From Carton of 50 7.62x39 API Cartridges .....	82
24. Packing Label for French-Made 7.62x63 Cartridges M1949 .....	91

<u>Figure</u>	<u>Page</u>
25. Box Marking for French-Made 7.62x63 Cartridges, Linked 4 Ball to 1 Tracer ..	92
26. Hungarian Wood Container Markings, 7.62x39 Ball Cartridges, Type PS .....	95
27. Carton Marking on Italian-Made 7.62x51 Ball Cartridges .....	101
28. North Korean Sheet-Metal Container Markings, 14.5x114 API, Type 63 Cartridges .....	105
29. Polish Sheet-Metal Container Marking, 7.62x39 Ball Cartridges .....	107
30. Romanian Sheet-Metal Container Markings, 14.5x114 API Cartridges .....	110
31. Carton Marking on Saudi Arabian 12.7x99 AP Cartridges .....	112
32. Syrian Wood Container Markings, 7.62x54R Ball Cartridges .....	119
33. Soviet Wood Container Markings, 7.62x39 Tracer Cartridges, Type T-45 ...	127

LIST OF TABLES

<u>Table</u>	<u>Page</u>
I. Small-Arms Cartridge Dimensions .....	37
II. Chinese Small-Arms Ammunition Color Coding Practice .....	75
III. Markings on Chinese Small-Arms Ammunition Labels and Containers ....	76
IV. Abbreviations and Terms on Czechoslovak Small-Arms Ammunition Packaging .....	79
V. Color Coding of Interior Packaging, Egyptian Small-Arms Ammunition .....	81
VI. Color Coding of Exterior Packaging, Egyptian Small-Arms Ammunition .....	84
VII. Arabic Terms on Small-Arms Ammunition Packaging .....	85
VIII. Abbreviations and Terms on Finnish Small-Arms Ammunition Packaging .....	86
IX. Prewar Color Coding Practice, French Small-Arms Ammunition .....	88
X. Postwar Color Coding Practice, French Small-Arms Ammunition .....	89
XI. Color Coding of Exterior Packaging, French Small-Arms Ammunition .....	92
XII. Abbreviations and Terms on French Small-Arms Ammunition Packaging .....	93
XIII. Abbreviations and Terms on Hungarian Small-Arms Ammunition Packaging .....	95
XIV. Prewar Color Coding Practice, Italian Small-Arms Ammunition .....	99
XV. Abbreviations and Terms on Italian Small-Arms Ammunition Packaging .....	100
XVI. World War II Color Coding Practice, Japanese Small-Arms Ammunition .....	102
XVII. Abbreviations and Terms on Dutch Small-Arms Ammunition Packaging .....	104
XVIII. Ammunition Terms on Norwegian Small-Arms Ammunition Packaging .....	106

<u>Table</u>	<u>Page</u>
XIX. Abbreviations and Terms on Polish Small-Arms Ammunition Packaging .....	108
XX. Ammunition Terms on Romanian Small-Arms Ammunition Packaging .....	111
XXI. Abbreviations and Terms on Spanish Small-Arms Ammunition Packaging .....	114
XXII. Abbreviations and Terms on Swedish Small-Arms Ammunition Packaging .....	116
XXIII. Small-Arms Ammunition Color Coding Practice, United Kingdom .....	121
XXIV. Small-Arms Ammunition Color Coding Practice, United States .....	125
XXV. Soviet Bullet Tip Color Codes and Bullet Type Designators .....	128
XXVI. Abbreviations on Soviet Small-Arms Ammunition Packaging .....	129
XXVII. World War II and Postwar Letter-Type Manufacturers' Codes .....	131
XXVIII. World War II German Small-Arms Ammunition Color Codes and Designators .....	132
XXIX. World War II and Postwar Abbreviations and Terms on German Small-Arms Ammunition Packaging .....	133
XXX. Abbreviations and Terms on Yugoslav Small-Arms Ammunition Packaging .....	134
XXXI. Obsolete Military Cartridges .....	201

## SECTION I

### INTRODUCTION

---

#### 1. General

a. The term "cartridge identification" can embrace a wide span of activities, ranging from the simple determination of a cartridge's designation in terms of its caliber and case length to a more complex analysis that can include its country of origin, functional type, model or type designation, and even lot number, year, and place of manufacture. This guide is generally limited in scope to cartridge designation and country and year of manufacture (though some data are provided on the identification of functional types and, for major producing countries, on the principal model or type designation) for cartridges in calibers of 15 mm and below. This breakoff point was selected because cartridges in this caliber range are predominately of the small-arms type, having bullets of relatively simple construction with, typically, a bullet jacket and a core. Cartridges of 20-mm and greater calibers, on the other hand, generally have artillery-type projectiles, either fuzed explosive types or solid monobloc projectiles with artillery-type rotating bands. There are at present no service types of military ammunition between 15 and 20 mm.

b. The problems involved in the identification of cartridges may be summarized in three questions, which this guide is designed to answer:

(1) What is the cartridge designation? This is expressed by a brief nomenclature, which includes a caliber (bullet diameter) measurement, that is applicable to all cartridges that can be fired in guns chambered for this specific cartridge.

(2) Who made the cartridge, and when? Normally this information can be derived from the markings that appear on the cartridge base, which are termed "headstamps." If the cartridge is unmarked, or if the markings are for any reason inadequate, it may be necessary to make a detailed examination and comparison with similar cartridges of known origin. Because of its technical complexity, such a comparison falls outside the scope of this guide; fortunately, such examples are relatively uncommon.

(3) What is its functional type: ball, tracer, incendiary, or even explosive? This identification involves color codes, stamped markings, or bullet shapes; these are often unique to the country of manufacture and, furthermore, may vary with the time period in which the cartridge was produced.

c. Some of the military cartridge types that are described in this guide have been produced for many years. Cartridges made during and even before World War II are not necessarily unserviceable because of their age; if they have been stored under favorable conditions of low humidity and low to moderate temperature, and if the brass cartridge case has not become brittle from exposure to the mercuric compounds in the primer, or from improper annealing of the metal, they may function quite reliably. Serviceability must be determined through inspection and testing by qualified ammunition specialists.

## 2. Organization

This guide comprises four major sections and two appendixes, with coverage as follows:

a. Section I outlines the scope of this guide and its organization. It also provides the general information on construction, characteristics, and terminology of small-arms cartridges that is essential for the effective utilization of this guide.

b. Section II provides instructions on the use of this guide in the identification of cartridges from dimensional and visual data.

c. Section III provides a series of outline drawings of cartridge cases; a tabulation of major cartridge dimensions; and a brief description of each cartridge type in terms of its origin, performance, using weapons, principal countries of manufacture and use, and current status. Cross-reference of information in these three areas is facilitated by the use of an index number that is assigned to each cartridge designation.

d. Section IV approaches the identification problem on a country-by-country basis. For each country the following information is provided where applicable:

- Headstamp practices
- Functional type identification
- Package markings
- Glossary of small-arms terms

e. Appendix I provides a reference set of approximately 650 headstamp markings that are representative of several thousand variant types. These are presented in four annexes: headstamps that contain Western (Roman) letters; headstamps with Cyrillic, Greek, Arabic, or Hebrew letters; headstamps with



Oriental characters or miscellaneous symbols as a major feature; and headstamps containing primarily Western numerals.

f. Appendix II provides limited identification data on 11 additional military cartridges, the use of which within the last 50 years has been too limited to justify their inclusion in section III.

### 3. Cartridge Cases

The primary feature in cartridge identification is the cartridge case. Its shape and dimensions, which must conform to the chamber size of the gun for which it is designed, indicate the type and probable military role of the weapon, which in turn may suggest the country of origin or the political inclinations of the user. From a supply point of view, the case is the most expensive as well as, normally, the heaviest component of the cartridge. Basically the cartridge case provides a reusable, watertight container for the primer, propellant, and bullet. Functionally the cartridge case serves several purposes; in particular, it provides a pressure seal in the gun chamber and serves as a heat sink to rid the gun of some of the heat generated during firing. Key aspects of cartridge-case design and construction are outlined in the following subparagraphs.

a. To provide desired performance characteristics, military cartridge cases must be robust; all are of centerfire construction, with a reinforced cartridge case head and a centrally located primer that initiates the propellant contained in the cartridge case. Case materials include brass, mild steel (either plated or lacquered), and aluminum; of these a brass alloy, typically about 70% copper, is predominant. Cases are manufactured by punch-and-die operations, termed "drawing," with heat treatment to provide desired metallurgical characteristics.

b. Primers for small-arms cartridges are with rare exceptions (for aircraft machinegun use in World War II) of the percussion type, initiated by the impact of a firing pin. Two types of percussion priming are in use, the Boxer and the Berdan primer. The United States, as well as some other countries that utilize US-made production machinery, uses the Boxer primer (which, incidentally, was invented by a British army officer). The Boxer primer consists of a primer cup containing a priming mixture and an integral anvil; the primer seat in the cartridge base is flat-bottomed with, normally, one axial flash hole. The Berdan primer, named after a US army officer, is predominant in the United Kingdom and Europe; the primer is a simple cup containing the priming mixture, while the anvil is formed as a part of the cartridge case. The Berdan primer normally has two flash holes, 180° apart, on either side of the anvil; a single offcenter hole has also been used with the intent of improving ignition by increasing the intensity of the primer flash. No

functional difference between the two types has been noted; many cartridges, such as the 7.62x51 NATO cartridge, may have either type, depending on the country of production. Figure 1 illustrates both types. Electric primers, which require an external current source of 24 to 28 V dc, were used by Germany in World War II on some 13x64B and 15x96 aircraft machinegun cartridges. Electric primers can be identified by the presence of an insulating ring around the primer.

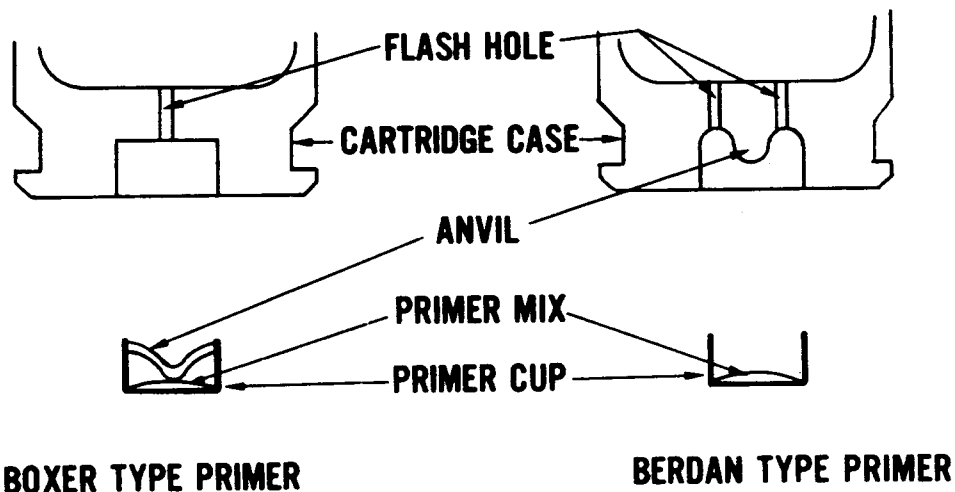

**BOXER TYPE PRIMER**

**BERDAN TYPE PRIMER**

Neg. 525253

Figure 1. Small-Arms Cartridge Primers

c. Cartridge base types, which serve a functional purpose in feeding and indexing the cartridge in the weapon, are valuable identifying features. The five types—rimmed, semirimmed, rimless, rebated, and belted—are illustrated in figures 2 through 6.

(1) Rimmed cartridge cases have a rim, or extractor flange, that extends beyond the cartridge body. Some rimmed cartridges, such as the 9x29R (.38 Special) may also have a groove in the case body ahead of the rim (fig 2).

(2) Semirimmed cartridge cases differ from rimmed cases in having a rim diameter only slightly greater than the case body diameter and an extractor groove in the case body adjacent to the rim. A semirimmed case can be identified by laying a straightedge along the cartridge body; a distinct gap will be noted just ahead of the extraction groove (fig 3 and 4).

(3) Rimless cartridges are identified by an extraction groove and by a rim diameter that is generally the same as the case body; it may be a fraction of a millimeter less or greater (fig 5).

SLIGHT UNDERCUT HERE  
IS PERMISSIBLE

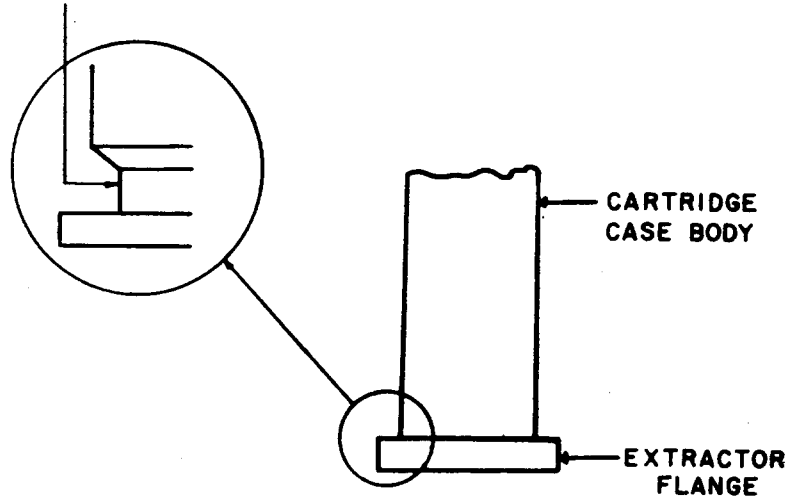

Neg. 525252

Figure 2. Rimmed Cartridge Case

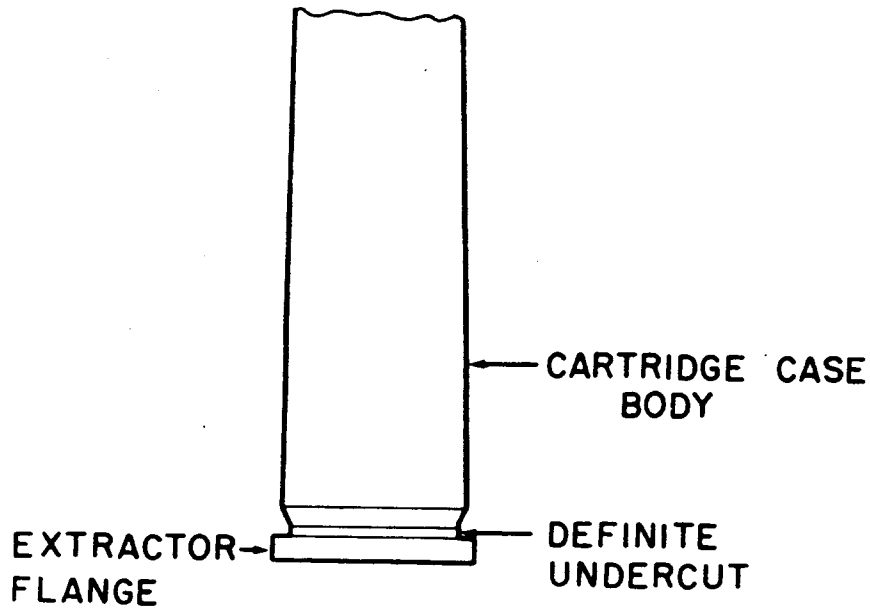

Neg. 525251

Figure 3. Semirimmed Cartridge Case

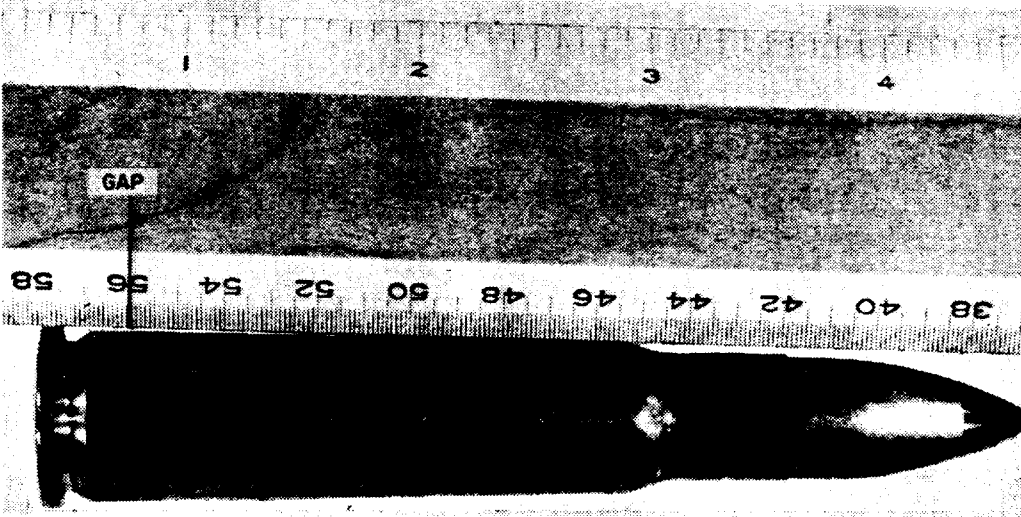

Neg. 525250

Figure 4. Identifying a Semirimmed Cartridge Case

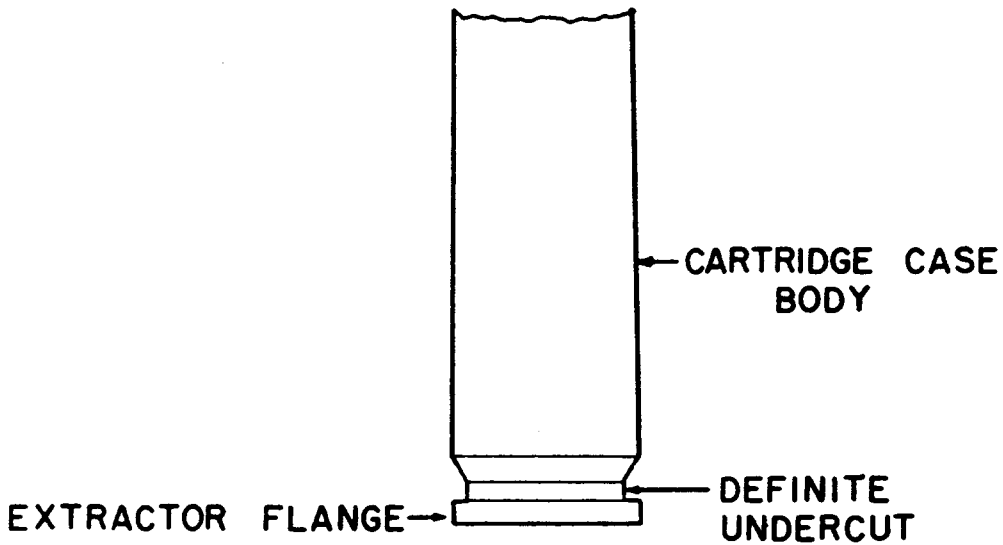

Neg. 525249

Figure 5. Rimless Cartridge Case

(4) The rebated base differs from the rimless base in the distinctly smaller diameter of the rim (fig 6).

(5) Belted cartridge cases have a pronounced raised belt around the cartridge case body ahead of the extractor groove. The rim diameter is not significant; it may be greater than, the same as, or less than the belt diameter (fig 7).

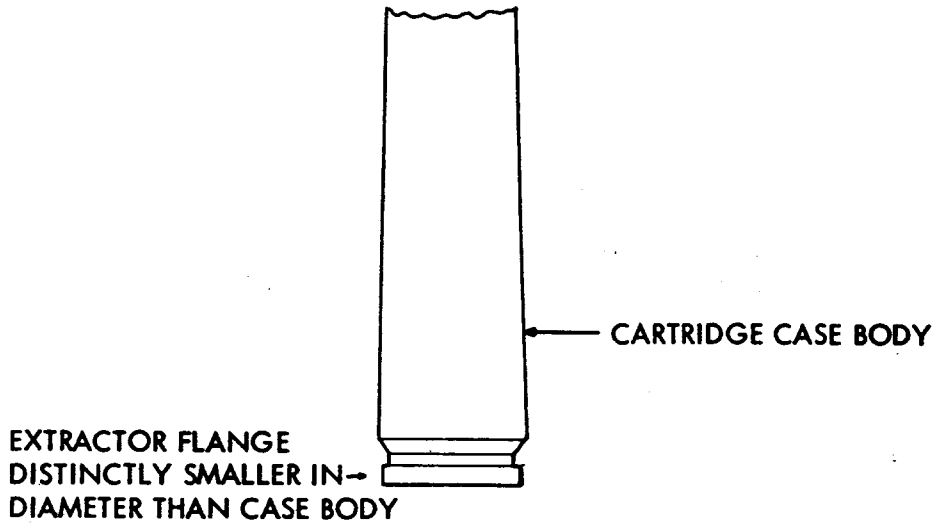

Neg. 524950

Figure 6. Rebated Cartridge Case

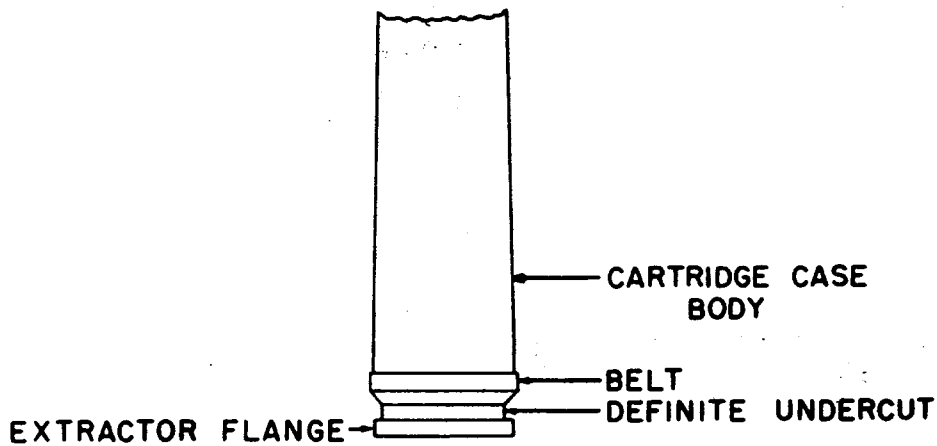

Neg. 525248

Figure 7. Belted Cartridge Case

d. Fired cartridge cases can provide information on caliber designation, country of origin, year of manufacture, and primer type. Cases may even carry a marking that indicates the functional type of the bullet that was fired. Finally, examination of a fired case by a weapon expert can, under favorable conditions, provide information as to the type of gun that fired the cartridge.

#### 4. Bullets

a. The shapes of bullets can be described as round-nose or spitzer (ogival, or pointed tip), and as flat-base or boattail. These characteristics are shown in figure 8. As a result of their poor ballistic qualities, round-nose bullets had gone out of general use for rifles and machineguns by the end of World War II in favor of spitzer types, except for low-velocity pistol and carbine cartridges and short-range training cartridges. Because of Hague Convention restrictions, as well as to provide better performance, service bullets with a lead core have a full metal jacket so that no lead is exposed at the front of the bullet.

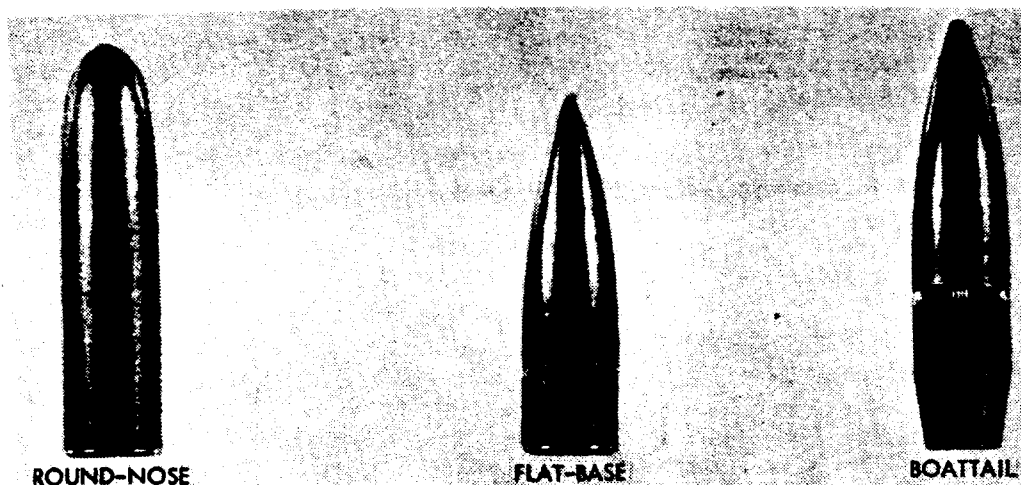

Neg. 524951

Figure 8. Typical Bullet Shapes

b. Bullets can also be classified in terms of functional design, such as ball; tracer (T); armor-piercing (AP); incendiary (I); high-explosive (HE); and observation and ranging, or spotter-tracer, types. Two or more of these functions may be combined in the same bullet, forming such combinations as AP-T, API, API-T, HEI, or HE-T. Not all types are made in every caliber; functional types are developed only to meet an expressed military requirement, and their configurations depend on the characteristics of the weapon and its ammunition, and on the intended target. Thus, pistols normally fire only ball cartridges; submachineguns may fire tracer bullets as well and, exceptionally, API bullets; and antiaircraft and aircraft machineguns may fire specialized types not used in ground guns. Each of these basic types is discussed briefly in the following subparagraphs.

(1) Ball bullets are intended for general use against personnel, unarmored vehicles, and light fortifications. A ball

bullet (sometimes designated an "ordinary" bullet in foreign terminology) normally has a full metal jacket of thin gilding metal, cupronickel, or plated mild steel. Internal construction may vary; a lead core or a lead-sheathed mild-steel core are usual, but two-part cores with a lightweight material (paper, aluminum, or steel) in the tip and a heavier material in the base have been made. As an exception, the now-obsolete 8x50.5R (Lebel) Balle D bullet was made of solid bronze.

(2) Tracer bullets are used for fire correction and target designation; they may have some incendiary effect as well. Two types of tracer bullets exist: luminous tracer bullets, which are the most widely used, and smoke tracer bullets.

(a) Luminous tracer bullets differ in construction from ball bullets only in having a pellet of pyrotechnic material in the bullet base, which is ignited by the burning propellant. Many variations in composition have been used; dim trace (for night use), red trace, orange trace, and white trace are the most common. Tracer cartridges cannot be distinguished from ball cartridges by visual examination unless they have a colored bullet tip or carry some other identification, depending on the country of manufacture. In case of doubt either an X-ray photograph or examination of a bullet removed from a cartridge will resolve the question; the pyrotechnic element will be visible in the bullet base.

(b) Smoke trace bullets usually contain white (yellow) phosphorus (WP), which burns on exposure to air to leave a spiral trail of white smoke. If handled incautiously these bullets may cause personal injury or start a fire. If no identifying coding is present, the bullet cannot be identified visually, since it has no visible pyrotechnic element in the base; an X-ray photograph will show its internal construction.

(3) AP bullets are similar in construction to ball bullets, except that the core is of hardened steel or, exceptionally, a tungsten alloy such as tungsten carbide, which is quite heavy, hard, and costly. AP bullets with tungsten alloy cores frequently bear the added designation HC for "hard core," or WC for "tungsten carbide." Depending on their impact velocity, hard-core AP projectiles may be up to 25% more effective in penetration because of the greater mass of the core. Again, visual identification will depend on the coding system used by the producing country.

(4) Incendiary bullets (or incendiary elements in combination bullets) usually contain a mixture of aluminum powder, magnesium powder, and barium nitrate that is ignited by impact and provides a flash of brief duration when the bullet jacket is ruptured. Some incendiary elements, however, contain

11 September 1981

HE or WP; these must be treated with caution. Visual identification will usually depend on the coding system used but may in some instances be established from the bullet's shape or construction features.

(5) HE bullets, while uncommon, exist, either in bullets designed for a fragmentation effect against aircraft or, less rarely, as a component of incendiary (HEI) or observation/tracer bullets. The fuze may be a simple air-gap type or a point-detonating fuze. Despite the small explosive payload, these bullets can be hazardous within a radius of several meters.

(6) Observation and ranging, or spotter-tracer, bullets are designed for fire adjustment; they may contain a small HE charge, an incendiary charge, or a combination of the two to provide a flash or a puff of smoke or dirt to indicate the point of impact. These bullets can cause injury if not handled with care.

## 5. Cartridge Designation

a. The term "cartridge designation" encompasses the approximate caliber of either the gun barrel or bullet as well as further identifying data that may include a model or type designation, year of adoption, or even the weapon for which the cartridge is designed. The same cartridge, moreover, may be identified by as many as three or even more names, which may identify one or more weapons in which used. The designations listed below, for example, all represent the same cartridge, with only minor variations in bullet and propellant:

- 7.65-~~mm~~ Borchardt
- 7.65-~~mm~~ Mannlicher carbine
- 7.63-~~mm~~ Mannlicher
- 7.63-~~mm~~ Mauser pistol
- .30 Mauser pistol
- 7.62-~~mm~~ Type P
- 7.62-~~mm~~ Type 50
- 7.62-~~mm~~ Tokarev, M30

In this series the first five and the last designation indicate specific weapons in which the cartridge is used; Type P is an arbitrary designation; and Type 50 refers to the year of adoption by China. To resolve this chaotic situation, a standardized metric cartridge designation system, which has been in use in



Europe since early in this century, will be used in this guide. This system is described in the following subparagraph.

b. The metric designation is basically composed of two numeric elements--the nominal bullet diameter and the case length--which are expressed in millimeters. The two elements are separated by the lower-case letter "x," which is read as "by"; e.g., the 7.62-mm NATO cartridge has a metric designation of 7.62x51, which is read as "seven point six-two by fifty-one." The first element, 7.62, is the nominal caliber of the bullet and corresponds to 0.308 inch; the second element, 51, expresses the nominal case length of a standard service cartridge. These values do not in all instances reflect the actual dimensions, which will vary from cartridge to cartridge, depending on the producer; they serve, however, as a convenient abbreviated code for identification and reporting. It will be noted that foreign cartridge designations frequently follow the European practice of using a comma where US and British practice requires a decimal point; the designation 7.5x55.5 thus may appear as 7,5x55,5. The two designations, however, are identical in meaning.

c. The two numeric elements are used alone when a rimless cartridge is involved; thus, the caliber .30-06 cartridge, which is rimless, becomes 7.62x63 in the metric version. Rimmed cases have a suffix R; the British .303 cartridge is designated 7.7x56R. Following the same system, rebated cases are identified by an RB suffix, semirimmed cases by SR, and belted cases by B. Rarely, two cartridges whose case dimensions are so different that functional interchangeability is impossible may have the same nominal caliber, case length, and rim type; here a further designation is added to differentiate between them. For example, there are two 8x50.5R cartridges, one French and the other Austrian; the first carries the designation Lebel; the other, Steyr.

d. For specific functional types of cartridges a supplemental nomenclature can be added, designating the functional type (Ball, AP, API-T) and, if appropriate, the specific model or type designation as well. Under this extended nomenclature a well-known US cartridge, the caliber .50 API, M8, will appear as cartridge, 12.7x99, API, M8; the service cartridge for the caliber .50 battalion antitank (BAT) spotting rifle becomes cartridge, 12.7x77, Spotter-Tracer, M48A1.

## 6. Headstamp Markings

a. The stamped markings that appear on a cartridge case base are termed the headstamp. The only general statement that can be made regarding cartridge headstamps is that the range of data that they can present is extremely varied. As a minimum military cartridge headstamps normally identify the producer and the year of production. Either or both of these elements may

consist of an abbreviation, a letter code, a numeric code, or an arbitrary symbol that is significant only to the user. The term "producer" is to be interpreted broadly; it may identify the specific plant that produced the ammunition, or it may identify the country by which (or for which) the ammunition was made, with a separate mark to identify the factory. Other markings may identify the month, quarter, or lot number of production; cartridge caliber; cartridge case material or case construction; or functional bullet type. Marks that appear to serve merely design or decorative purposes--such as stars, dots, or arcs--frequently have a specific meaning for the producer or the intended user.

b. In describing headstamps, it is convenient to use the term "design element" to indicate bits of information that may be found together in a headstamp. If only one element, such as "7.62-mm," is present, this is termed a single-element headstamp; if two elements, such as "7.62-mm" and "3-76" are present, they constitute a two-element headstamp, and so on.

c. Location of the design elements can be indicated in either of two ways, depending on which is most convenient for the cartridge case at hand: either by its clock-face orientation, in which 12 o'clock is at the top, 3 o'clock at the right, 6 o'clock at the bottom, and 9 o'clock at the left, or by the angular orientation. A two-element headstamp with one element at 12 o'clock and the other 6 o'clock, or with one at 3 o'clock and one at 9 o'clock, would be termed a 2x180 pattern; if three elements were distributed equidistantly, it would be termed a 3x120 pattern (fig 9-13).

d. Some headstamp designs include one or two segment lines that divide the cartridge base into either two or four equal parts or fields in which markings may or may not appear. Segment lines are a design feature that was relatively popular in Europe from 1880 to 1920, but has since gone gradually out of use; very few producers now follow this practice (fig 14).

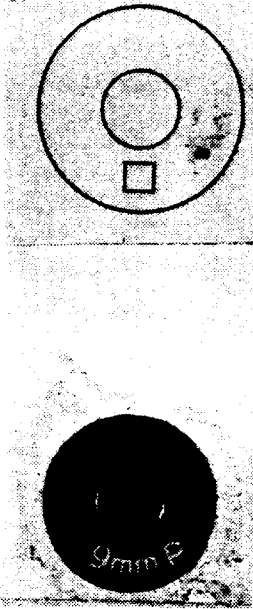

Neg. 525247

Figure 9. Single-Element Headstamp

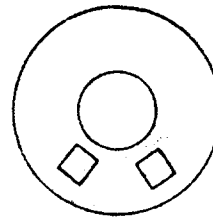
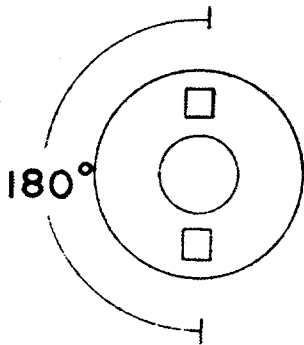

2X 180



SIDE-BY-SIDE

Neg. 525246

Figure 10. Two-Element Headstamps

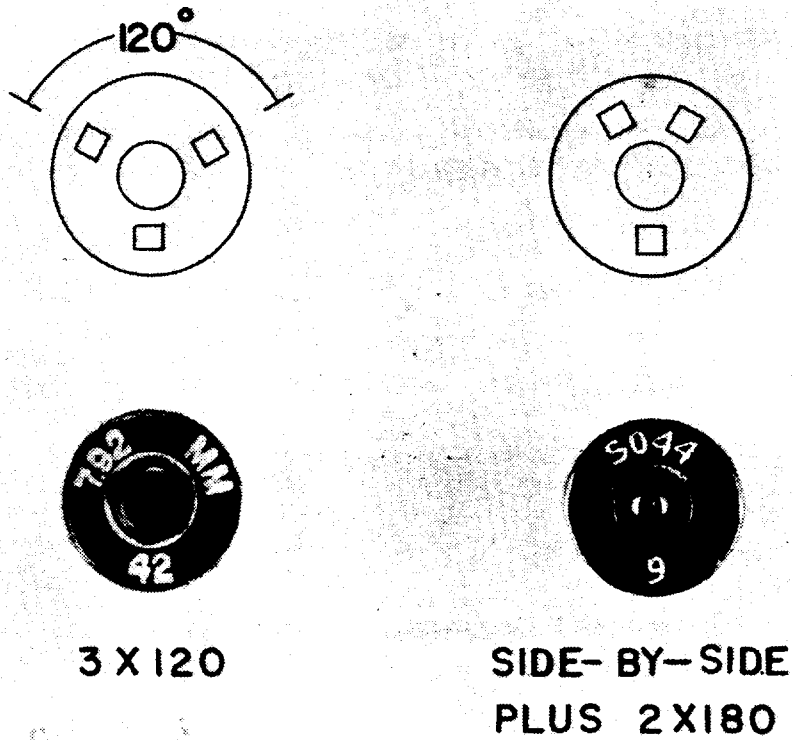

Neg. 525245

Figure 11. Three-Element Headstamps

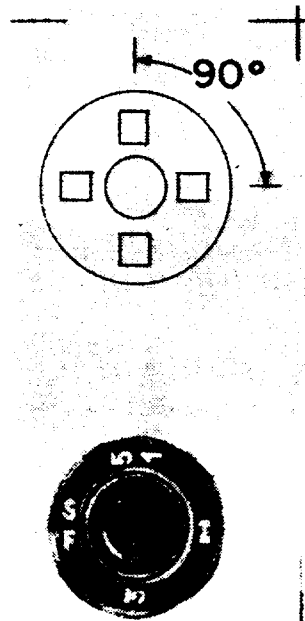
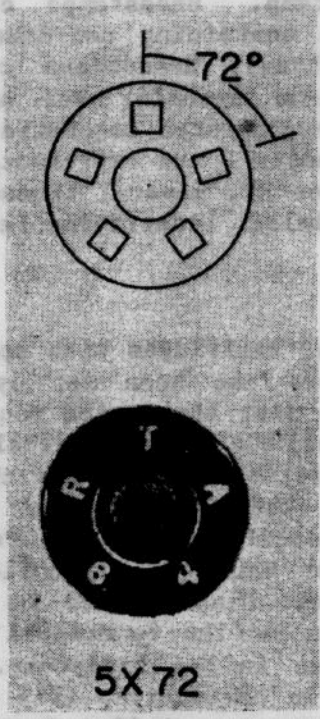
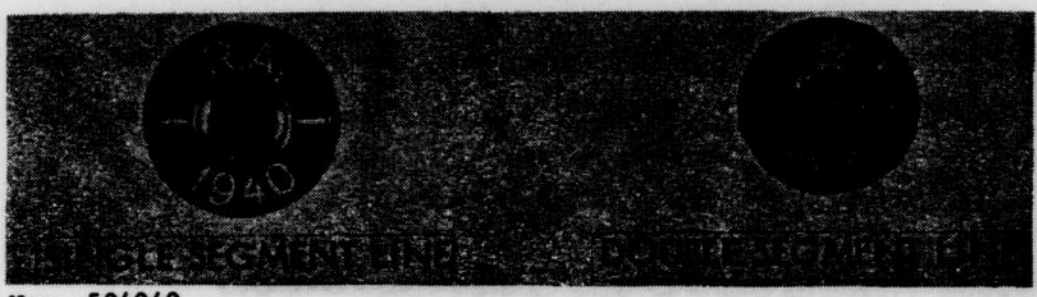

Figure 12. Four-Element Headstamp



Neg. 525243  
Figure 13. Five-Element Headstamp



Neg. 524949  
Figure 14. Headstamps With Segment Lines

e. Some countries have characteristic or unique headstamp marking systems, which are described in section IV; a study of these national marking patterns will provide a good background for the identification of cartridges by their headstamps. It must be emphasized that headstamp markings must be considered together with the cartridge caliber, year of manufacture, and with any color or other identification markings that may be present.

f. Representative headstamps are presented in appendix I; they are divided into four groups depending on the principal

identifying element of the headstamp. Headstamps containing Roman (Western) letters; headstamps containing non-Roman alphabets (Greek, Cyrillic, Arabic, Hebrew); headstamps containing Oriental characters and miscellaneous symbols; and headstamps containing only Western numerals are presented sequentially. The approximately 650 headstamps in appendix I are representative of, and can be used in the identification of, several thousand variant types that contain the same or similar identifying features.

## 7. Functional Type Markings

a. The need for recognition of cartridges with specialized bullets such as tracer or AP types has been met by several identification systems, developed to meet the varied requirements of using countries. Some countries have used several systems over a period of years, as bullet calibers and types changed or political factors came into play. These specialized cartridge types have been most frequently identified by a colored bullet tip, often in combination with color bands on the bullet. Less frequently, a color band or ring has been applied to the case mouth, the case body, or the primer, or the functional type has been indicated by letters or figures in the headstamp. All of these methods may be used alone or in combination (fig 15). For tactile identification in darkness, a tracer bullet formerly made for US submachineguns had a cross impressed in the nose of the round-nosed bullet.

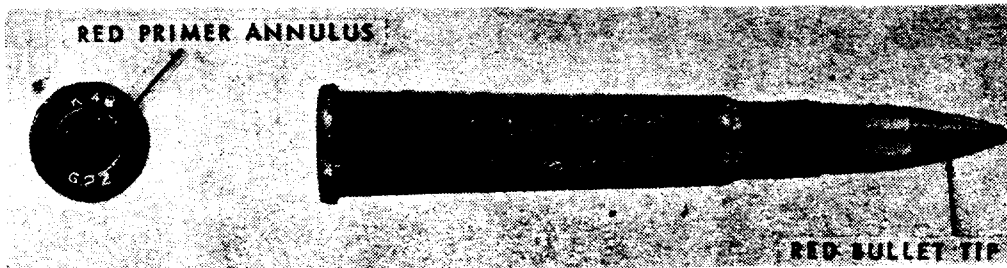

Neg. 525242

Figure 15. Tracer Cartridge With Bullet Tip and Primer Annulus Color Identification

b. Two systems of bullet-tip color coding are in widespread international use: The US/NATO system, which is also used by many non-NATO but western-oriented countries, and the Soviet color code, in use through the Eurasian Communist countries (ECC) and in some Third World countries as well. Many countries have supplemented these international marking systems with additional national codes.

c. Color codes used by the major cartridge-producing countries, as well as the calibers and types of cartridges that they identify, are presented in section IV for each country concerned.

SECTION II

CARTRIDGE IDENTIFICATION PROCEDURES

---

1. General

To identify an unknown cartridge or a fired cartridge case with the aid of this guide, all that is needed is an accurate measuring device. Since all measurements are given in metric units, a vernier caliper that reads to 0.1 mm is entirely adequate; in an emergency a metric scale that reads to 0.5 mm may be used, although with some decrease in accuracy. Calipers or micrometers graduated in inches will also serve, provided that the measurements are converted to metric units. Since one inch is equal to 25.4 mm, the inch measurement (in decimals, not in fractions of an inch) is multiplied by 25.4 to arrive at the metric measurement.

2. Caliber and Cartridge Designation

a. As has been noted, cartridge designation is expressed by a nominal caliber and case length. Data in this guide, however, are presented in order of case length as the principal identifying factor, and thereafter in order of increasing caliber. The first step is to measure the cartridge case length and bullet diameter--or, for a fired case, the case mouth diameter--and note the type of cartridge base (fig 16). Either of two methods can then be followed to establish the cartridge designation.

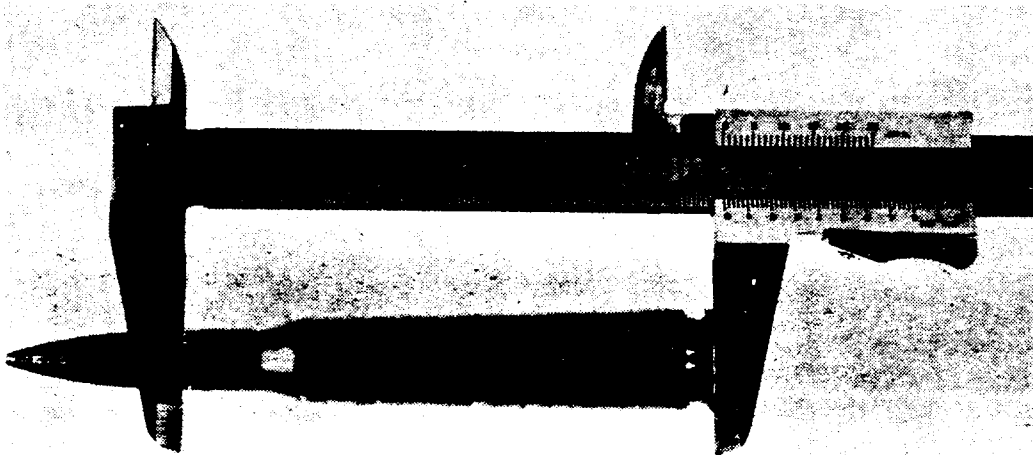

Neg. 531858

Figure 16. Measuring Cartridge Case Length  
With a Vernier Caliper

b. For a rough-and-ready identification, refer to the cartridge case outline drawings in section III. Look for a cartridge case drawing whose designation indicates a case length that matches the unknown cartridge, and which has the same type of cartridge head. The case lengths may not be identical, but a case outline can usually be found that is a close match to the unknown cartridge or case. A proper match is achieved when an even border of white is visible around the cartridge case, when it is laid over the outline drawing. Figure 17 shows an example of a proper fit, while figure 18 shows two examples of an improper match; the cartridge on the left has a case neck and mouth that are distinctly smaller than the outline, while the cartridge on the right shows several incorrect fits:

- The cartridge case head and body are too small in diameter.
- The cartridge body profile is not parallel to the outline drawing.
- The cartridge case has no shoulder, whereas one is shown in the outline drawing.
- The cartridge case is shorter than the outline drawing.

Having found a good fit, note the applicable cartridge designation and the corresponding index number. For further information refer to section III, paragraph 3 of this guide, where data on the origin, characteristics, and use of this cartridge will be found by reference to its index number.

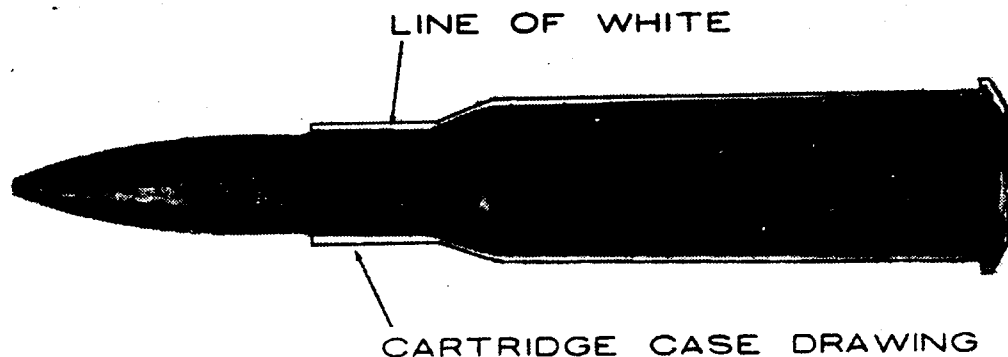

Neg. 525240

Figure 17. Example of Proper Fit Between Cartridge Case and Outline Drawing



11 September 1981

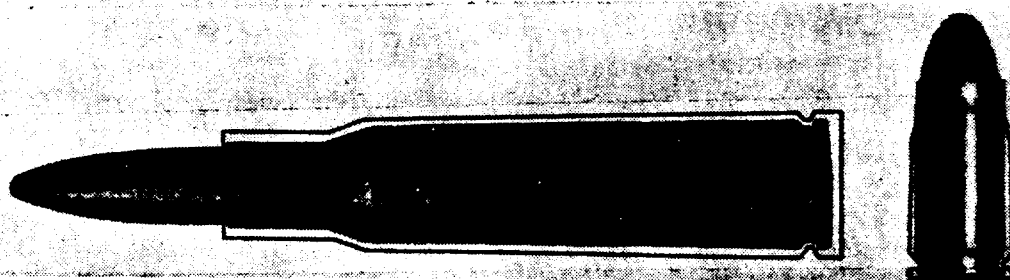

Neg. 525239

Figure 18. Example of Improper Fit Between Cartridge Case and Outline Drawings

c. For a more detailed identification measure the cartridge case length and bullet or case mouth diameter as before, and in addition measure the case diameters at the following points: rim (the rearmost diameter of the cartridge case), case head (or belt, for belted cartridges), and case mouth. In figure 19, point A indicates the rim diameter to be measured, and point B the case or belt diameter. Using the case length as a key dimension, refer to the tabulation of case dimensions in section III, paragraph 2, to find the cartridge designation with base type and dimensions to match those of the unknown cartridge. The dimensions in this table are representative measurements; individual cartridges, and particularly fired cases, may vary slightly from the dimensions shown. Although the bullet diameter should be very close to the indicated value, the case length may be as much as 1 mm less than the dimension given, while diameters may be up to 0.5 mm more or less than the figures shown.

d. Identification data on sporting cartridges and older military cartridges not included in this guide can be found in the sources listed at the end of this guide.

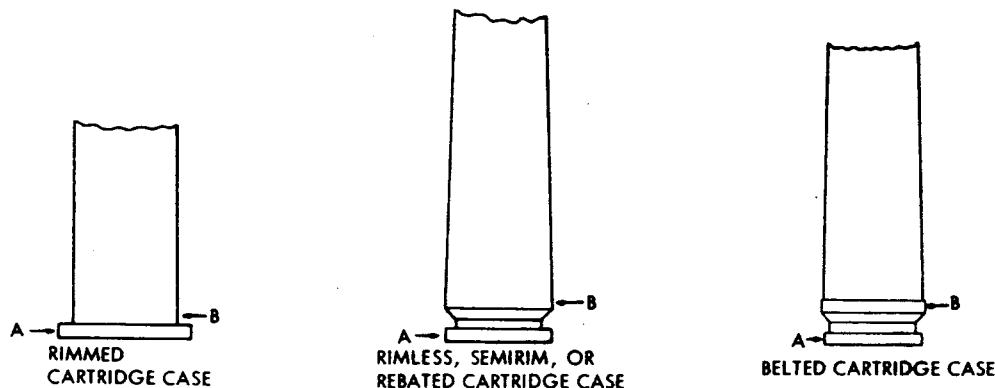

Neg. 524948

Figure 19. Location of Rim and Head Measurements

### 3. Country and Year of Manufacture

a. The first step in determining the country of manufacture--or, in some instances, for whom the cartridge was manufactured--is to examine the headstamp to ascertain the principal identification element. For the majority of headstamps one or more letters of the Western alphabet will be present; these are often, but not invariably, the manufacturer's or producer's mark. If such letters are present, look for a comparable headstamp in appendix I, annex A. Even though the exact headstamp may not appear, a reasonably close match in style and layout will usually be found. Note the country and year of manufacture. If a year or span of years of production is given in the caption, compare this with the year date in the cartridge headstamp, if there is one. Next, refer to sections III and IV of the guide and compare the headstamp data with the information that is given on that cartridge and on the marking practices of the indicated country of origin, including the glossary of foreign terms. If the cartridge is one that is appropriate for the country in question to have made in the year that appears in the headstamp, the probability is strong that the identification is valid.

b. If no Western letters appear in the headstamp, select the most probable element or elements present, and look in the appropriate annex of appendix I for a similar type of headstamp. Having noted the country indicated and any indication of year that may be present, follow the procedure outlined in the preceding subparagraph. Good judgment and consideration of the probable or indicated period of manufacture should help to resolve most questions of doubt, although, as appendix I indicates, a firm identification is not possible in every instance. Furthermore, new headstamp types, as well as caliber designations, may be found that are not covered in this guide.

c. The year of manufacture may be indicated by a two-digit or four-digit year code, in a foreign numeric code (Arabic or Oriental), or in a letter code. Each of these is explained where applicable, either in appendix I or under the country of manufacture.

### 4. Functional Type

a. Identification of a cartridge as to functional type is dependent on the cartridge designation, country of origin, and year or other time period of manufacture, together with any color coding or other identifying marking and whatever visible construction details may be present, such as a two-piece bullet jacket, a flat bullet tip, or a nose fuze. This information is then compared with the data presented in section IV for the country indicated. If a question still exists as to its functional type, and especially if a possible hazard exists, an

X-ray examination by a responsible agency will resolve the question.

b. Fired tracer bullets can be identified by the characteristic base cavity for the pyrotechnic element; fired bullets may even contain unburned tracer mix, which presents no hazard. Bullets with tracers, however, may also contain incendiary or even explosive material; thus, the fact that a bullet has been fired does not always insure that no hazard remains. This is of course especially true for explosive types with a visible fuze.

c. Some information can be gained by testing the cartridge case and bullet with a magnet; this will determine whether either component contains ferrous materials. This is not a conclusive test, as even a completely nonferrous cartridge (brass case, gilding metal bullet jacket, lead core) may contain an incendiary mixture or a tracer element. Removal of unknown types of bullets from the cartridge case for examination involves a degree of risk and should not be attempted by collectors in the field.

#### 5. Box and Package Markings

a. Although the information that they contain will vary, depending on each producer's marking practice, box and package markings usually provide as a minimum firm identification of their contents as to country of manufacture, cartridge designation, functional type, and date of manufacture. They frequently contain, in addition, producer codes and lot number data and may even provide detailed information on cartridge components, such as the type and quantity of propellant and its producer. A study of package markings frequently can yield information that could otherwise be provided only by an extensive laboratory examination of the cartridges themselves.

b. The first step in identifying cartridges from package labels or container markings is to establish the country of origin; the style of container marking, the language or alphabet used, and the terminology in the markings normally leave little room for doubt. There are, however, exceptions. Containers of cartridges produced for commercial sale may carry markings in English, using UK or US terminology. Even more, some foreign producers of US military cartridge types have followed US specifications as to packaging and marking so closely that only the producer code and lot number reveal the origin of the cartridges. An examination of cartridge headstamps (which normally agree with the producer code indicated on the container) will confirm the identification. Finally, during World War II the United States made cartridges for the Republic of China (ROC) with containers that carried stenciled markings in Chinese; when translated, however, these identified the United States as the country of origin. Containers with markings in Cyrillic may be of Soviet, Bulgarian, or Yugoslav origin; identification can be

established by referring to section IV, where examples of package marking and of differences in terminology are presented. The same holds true for package markings or labels in Arabic, which can be identified by comparing them with the examples in section IV of package marking of major Arab producers.

c. The second step in identification is to determine the cartridge designation, its functional type, and, if possible, its model or type designation. This can often be read from the box markings and interpreted or translated by reference to the marking data and language glossaries that are presented in section IV of this guide.

d. Container markings frequently include color-code markings that further identify the functional type of the contents. These markings are usually, but not always, similar to the color coding of the cartridges themselves. The type or style of these markings, and the colors used, should be noted and recorded for comparison with the data provided in section IV. Whenever possible, information from package markings should be correlated with that obtained from examination of the cartridges themselves.



SECTION III

CARTRIDGE IDENTIFICATION DATA

---

1. Cartridge Case Outline Drawings

Index No. 1  6.35x15.5SR

Index No. 2   
Index No. 3  7.65x17  
7.65x17SR







Index No. 4  9x17





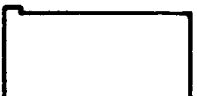

Index No. 5  9x18

Index No. 6  9x19

Index No. 7  11.43x19R

DST-1160G-514-81-VOL 1  
11 September 1981

Index No. 8		7.65x20
Index No. 9		9x20SR
Index No. 10		9x20R
Index No. 11		7.65x21
Index No. 12		8x21
Index No. 13		7.65x22

Index No. 14		9x22
Index No. 15		7.5x22.5R
Index No. 16		9x23
Index No. 17		9x23SR
Index No. 18		11.43x23
Index No. 19		11.43x23R

DST-1160G-514-81-VOL 1  
11 September 1981



Index No. 20

11.43x23.5SR



Index No. 21

7.62x25



Index No. 22

9x25



Index No. 23

8x27R



Index No. 24

9x29R



Index No. 25

7.62x33

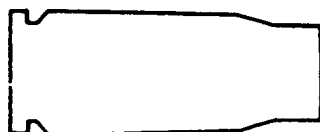

Index No. 26

7.92x33





Index No. 26a

5.45x39



Index No. 27

5.6x39



Index No. 28

7.62x39



Index No. 29

7.62x39R



Index No. 30

5.56x45



Index No. 31

7.62x45



**Index No. 32**

**4.85x49**



**Index No. 33**

**6.5x50.5SR**

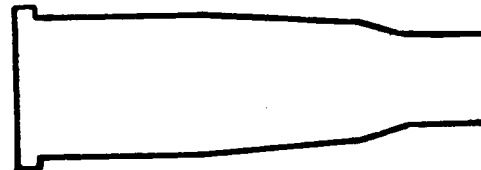

**Index No. 34**

**8x50.5R (Label)**

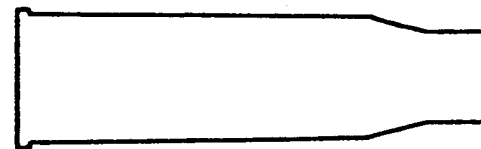

**Index No. 35**

**8x50.5R (Steyr)**



**Index No. 36**

**7x51**

**Index No. 37**

**7.62x51**



**Index No. 38**

**7.35x52**

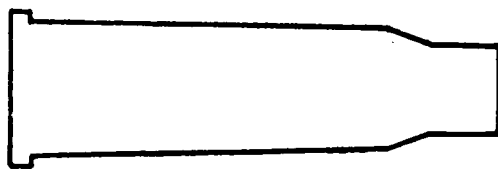

Index No. 39

8x52R

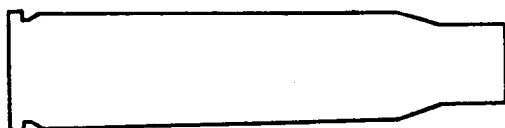

Index No. 40

6.5x52.5

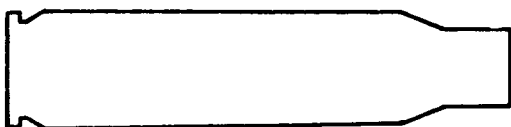

Index No. 41

6.5x53.5



Index No. 42

7.65x53.5



Index No. 43

6.5x54R



Index No. 44

7.5x54



Index No. 45

7.62x54R



Index No. 46

6.5x55



Index No. 47

7.5x55.5



Index No. 48

7.7x56R

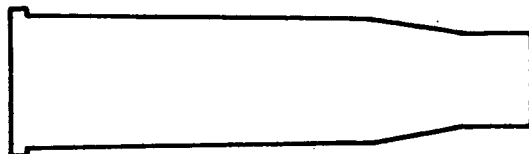

Index No. 49

8x56R



Index No. 50

7x57



Index No. 51

7.92x57

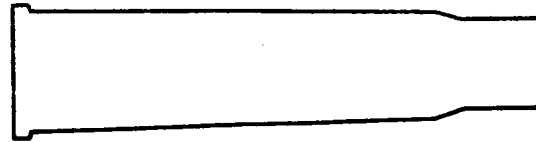

Index No. 52

7.92x57R (Dutch)



Index No. 53

6.5x58



Index No. 54

7.7x58

Index No. 55

7.7x58SR

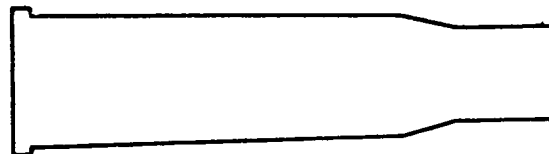

Index No. 56

8x58R



Index No. 57

8x59RB



Index No. 58

7.92x61RB

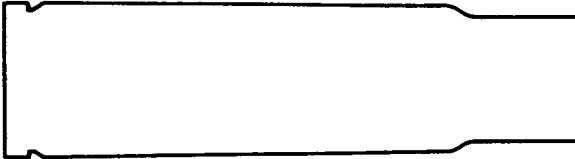

Index No. 58a

11.35x62



Index No. 59

7.62x63



Index No. 60

8x63



Index No. 61

13x64B

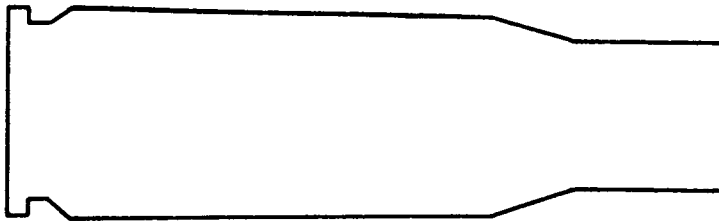

**Index No. 62**

**12.7x77**

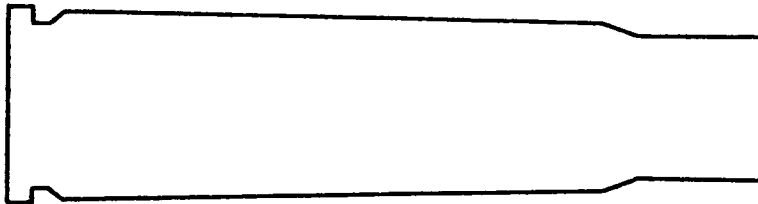

**Index No. 63**

**12.7x80**

**Index No. 64**

**12.7x81SR**

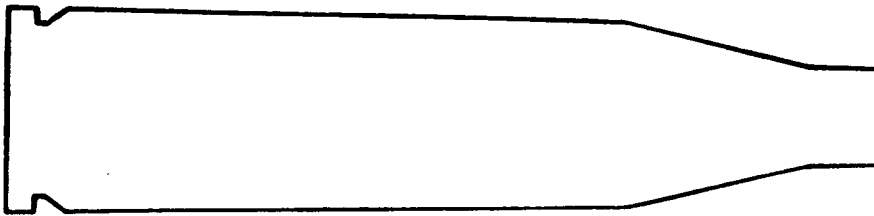

**Index No. 65**

**7.92x94**

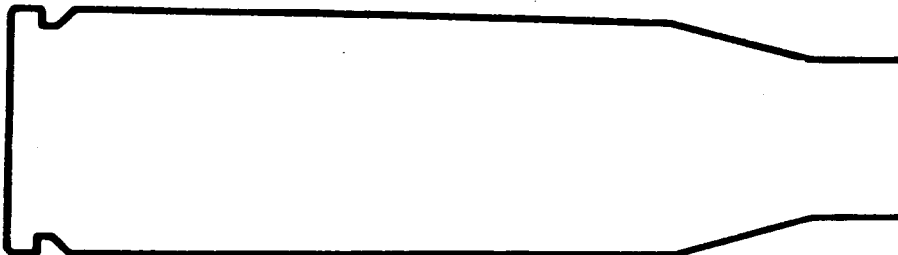

**Index No. 66**

**15x96**

DST-1160G-514-81-VOL 1  
11 September 1981

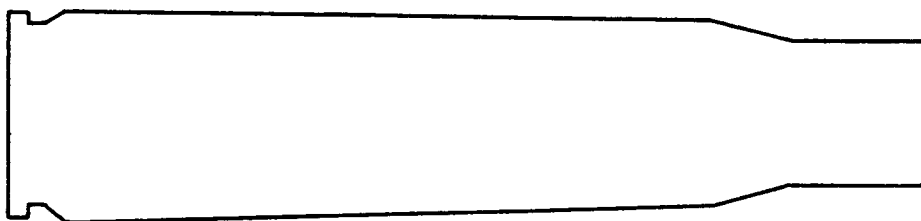

Index No. 67

12.7x99

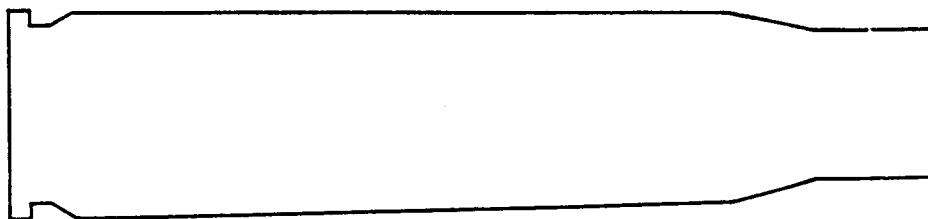

Index No. 68

13.2x99

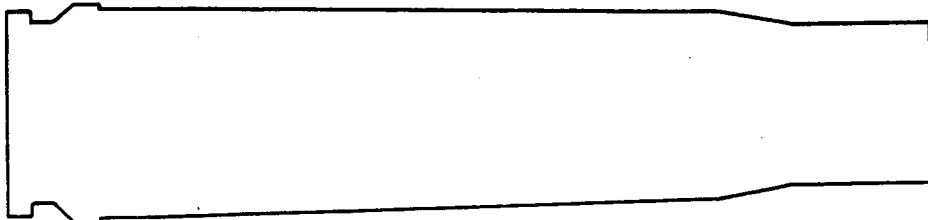

Index No. 69

13.9x99B



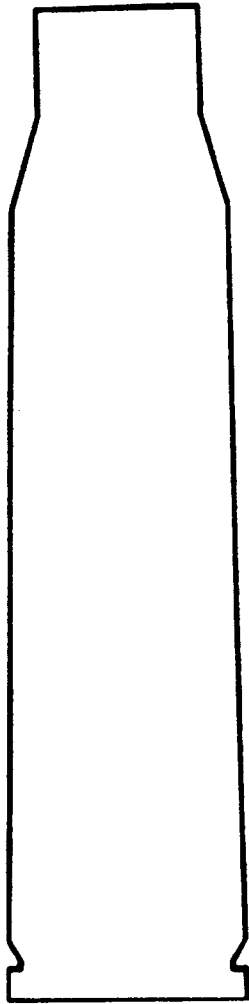

Index No. 70  
15x105

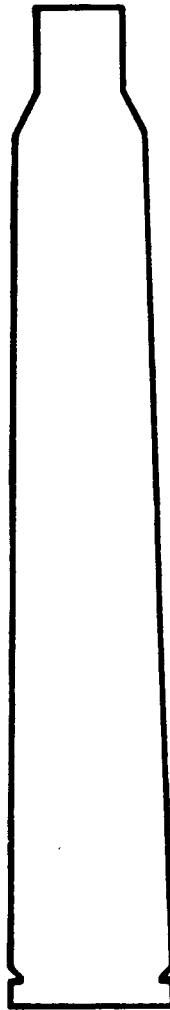

Index No. 71  
7.92x107

DST-1160G-514-81-VOL 1  
11 September 1981

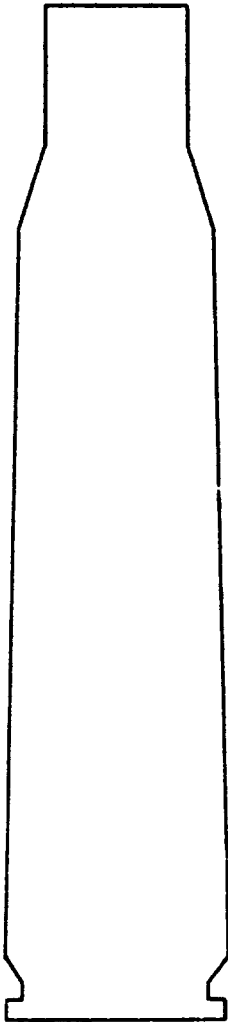

Index No. 72  
12.7x108

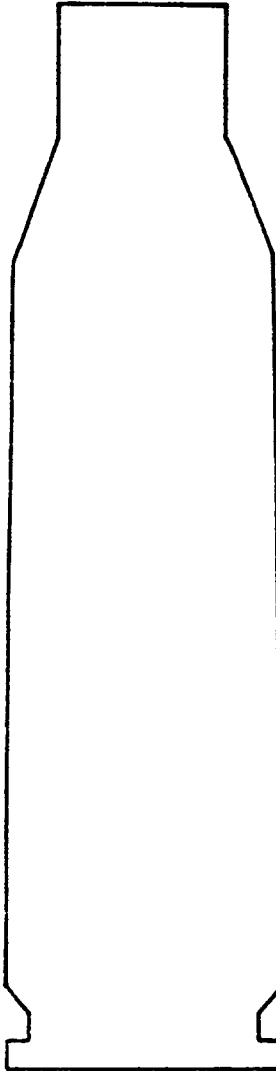

Index No. 73  
14.5x114

DST-1160G-514-81-VOL 1-CHG 2  
29 May 1987

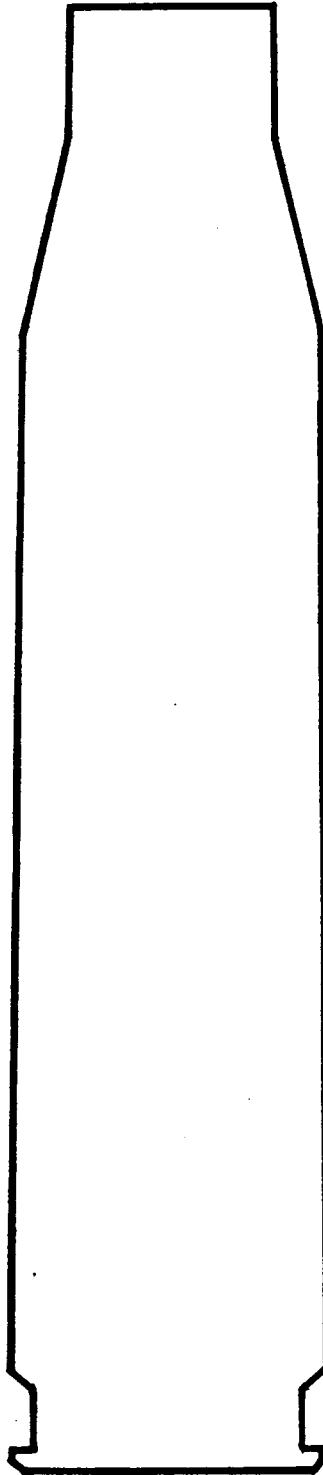

Index No. 74  
15x115

36.1  
(Reverse Blank)

2. Dimensional Data

Table I provides dimensions of the cartridges whose case outlines appear in paragraph 1. The dimensions that appear in this table are those of standard cartridges; as has previously been noted, individual cartridge dimensions may vary from the figures given. The index numbers facilitate cross-references to data in paragraphs 1 and 3.

Table I. Small-Arms Cartridge Dimensions

Index number	Cartridge designation	Case type	Cartridge-case dimensions (in mm)				Bullet diameter
			Length	Rim diameter	Head diameter	Mouth diameter	
1	6.35x15.5SR	Semirimmed	15.7	7.6	7.0	7.0	6.4
2	7.65x17	Rimless	17.0	8.4	8.4	8.1	7.8
3	7.65x17SR	Semirimmed	17.0	8.9	8.4	8.1	7.8
4	9x17	Rimless	17.2	9.5	9.5	9.5	9.0
5	9x18	do	18.0	9.9	9.9	9.8	9.2
6	9x19	do	19.3	9.9	9.9	9.9	9.0
7	11.43x19R	Rimmed	19.5	13.6	12.2	12.1	11.5
8	7.65x20	Rimless	20.0	8.6	8.6	8.5	7.8
9	9x20SR	Semirimmed	20.2	10.2	9.7	9.5	9.0
10	9x20R	Rimmed	20.1	11.1	9.8	9.8	9.1
11	7.65x21	Rimless	21.3	8.5	8.4	8.4	7.8
12	8x21	do	21.4	10.5	10.4	8.6	8.1
13	7.65x22	do	21.6	9.9	9.9	8.3	7.8
14	9x22R	Rimmed	22.0	11.0	9.9	9.5	9.0
15	7.5x22.5R	do	22.6	10.3	8.8	8.5	8.0
16	9x23	Rimless	23.0	9.9	9.9	9.6	9.0
17	9x23SR	Semirimmed	23.0	10.3	9.7	9.7	9.1
18	11.43x23	Rimless	22.8	12.0	12.0	12.0	11.5
19	11.43x23R	Rimmed	22.8	13.1	12.0	12.0	11.5
20	11.43x23.5SR	Semirimmed	23.6	12.7	12.1	12.0	11.5
21	7.62x25	Rimless	24.7	9.9	9.9	8.4	7.8
22	9x25	do	25.1	10.0	10.0	9.6	9.1
23	8x27R	Rimmed	27.2	10.1	9.1	8.9	8.2
24	9x29R	do	29.5	11.2	9.6	9.6	9.1
25	7.62x33	Rimless	32.8	9.0	9.0	8.4	7.8
26	7.92x33	do	32.8	11.9	11.8	9.0	8.2
26a	5.45x39	do	39.5	10.0	10.0	6.3	5.6
27	5.6x39	do	38.6	11.2	11.2	6.2	5.6
28	7.62x39	do	38.6	11.2	11.2	8.6	7.8
29	7.62x39R	Rimmed	38.6	9.7	9.1	7.3	7.5
30	5.56x45	Rimless	44.7	9.5	9.4	6.4	5.7
31	7.62x45	do	44.9	11.2	11.2	8.6	7.8
32	4.85x49	do	49.2	9.5	9.5	5.5	4.9
33	6.5x50.5SR	Semirimmed	50.8	12.0	11.6	7.4	6.7
34	8x50.5R (Lebel)	Rimmed	50.3	16.0	13.8	8.8	8.2
35	8x50.5R (Steyr)	do	50.3	14.1	12.7	8.9	8.2
36	7x51	Rimless	49.5	12.0	12.0	8.0	7.2
37	7.62x51	do	51.1	12.0	11.9	8.6	7.8
38	7.35x52	do	51.1	11.4	11.3	8.2	7.6
39	8x52R	Rimmed	52.0	14.3	12.9	8.9	8.2
40	6.5x52.5	do	52.1	11.4	11.3	7.5	6.7
41	6.5x53.5	do	53.1	11.4	11.3	7.3	6.7
42	7.65x53.5	do	53.4	12.0	11.9	8.6	7.9
43	6.5x54R	do	53.4	13.3	11.4	7.5	6.7
44	7.5x54	Rimless	53.6	12.2	12.2	8.6	7.8
45	7.62x54R	Rimmed	53.6	14.2	12.4	8.4	7.9
46	6.5x55	Rimless	54.9	12.2	12.2	7.4	6.7
47	7.5x55.5	do	55.5	12.6	12.5	8.5	7.7
48	7.7x56R	Rimmed	56.1	13.5	11.6	8.6	7.9

★Table I. Small-Arms Cartridge Dimensions (Continued)

Index number	Cartridge designation	Case type	Cartridge-case dimensions (in mm)				Bullet diameter
			Length	Rim diameter	Head diameter	Mouth diameter	
49	8x56R	Rimmed	56.0	14.1	12.5	9.0	8.2
50	7x57	Rimless	56.7	12.1	12.0	8.1	7.3
51	7.92x57	do	57.0	12.0	11.9	8.9	8.2
52	7.92x57R (Dutch)	Rimmed	56.8	13.4	11.9	8.9	8.1
53	6.5x58	Rimless	57.9	11.8	11.9	7.5	6.7
54	7.7x58	do	57.9	12.1	12.1	8.6	7.9
55	7.7x58SR	Semirimmed	57.9	12.7	12.1	8.6	7.9
56	8x58R	Rimmed	57.9	14.6	14.0	9.0	8.2
57	8x59RB	Rebated	59.0	12.2	12.5	9.1	8.2
58	7.92x61RB	do	61.0	11.9	12.3	8.9	8.2
58a	11.35x62	Rimless	61.6	16.0	15.9	12.6	11.66
59	7.62x63	do	63.2	12.0	11.9	8.6	7.8
60	8x63	do	63.2	12.2	12.4	9.0	8.2
61	13x64B	Belted	63.8	17.0	17.9	13.8	12.8
62	12.7x77	Rimless	77.0	20.3	20.2	14.0	13.0
63	12.7x80	do	80.1	18.2	18.3	13.8	13.0
64	12.7x81SR	Semirimmed	80.8	19.5	18.3	13.8	13.1
65	7.92x94	Rimless	94.0	21.0	21.0	9.5	8.3
66	15x96	do	95.8	25.2	25.1	15.9	15.1
67	12.7x99	do	99.2	20.3	20.2	14.0	13.0
68	13.2x99	do	96 to 98.8	20.1	19.9	14.4	13.5
69	13.9x99B	Belted	98.8	20.3	21.9	14.9	14.0
70	15x105	Rimless	104.5	24.7	24.6	16.4	14.5 (bourrelet)
71	7.92x107	do	107.2	16.3	16.3	9.2	8.2
72	12.7x108	do	108.0	21.8	21.6	14.0	13.0
73	14.5x114	do	113.8	26.9	26.9	16.2	14.8
74	15x115	do	114.9	24.7	24.7	15.5	15.0

### 3. Cartridge Reference Data

a. This paragraph presents information on the development, service use, and performance characteristics of the cartridges listed in table I.

b. The term "practical range" as used in this guide is defined as an estimate of the range at which an average soldier would have an even chance--a 50% probability--of hitting an adversary. The effective range is the maximum range at which firing can be conducted with sufficient accuracy (although with reduced hit probability) and remaining bullet energy to inflict casualties or cause damage.

c. It is emphasized that this guide is limited to identification of ammunition based on its physical characteristics. Identification of a cartridge does not imply, and will not insure, that the cartridge can be safely fired in, or will properly function in, any weapon except an appropriately chambered weapon design for the cartridge and made in the same country as the cartridge.

Index No. 1

6.35x15.5SR

Other Designations: .25 Auto; .25 ACP.

★This low-power cartridge was developed in Belgium in 1906 and introduced in the United States in 1908 for small pocket automatic pistols of Browning design. The full metal jacketed bullet weighs 3.25 grams. Muzzle velocity ranges from 225 to 247 m/s, depending on the manufacturer. Practical range does not exceed 15 meters. This cartridge and pistols designed to fire it have been produced by numerous manufacturers in many countries over the past 70 years. Except perhaps in Spain, the cartridge has no military application, but pistols chambered for this cartridge have been used by security forces in several European countries.

Index No. 2

7.65x17

Other Designations: 7.62x17; Type 64.

Other than in the smaller diameter of the rim, this cartridge is identical in dimensions to the 7.65x17SR cartridge, Index No. 3, and is probably similar in performance. The cartridge was introduced in 1964 by China for use in the Type 64 and Type 67 silenced pistols, which will not accept the 7.62x17SR cartridge. The full metal jacketed bullet weighs 4.8 grams. This cartridge is believed to be manufactured only in China.

Index No. 3

7.65x17SR

Other Designations: 7.65 Auto; 7.65 Browning;  
.32 ACP; .32 Auto Colt.

★This cartridge was developed at the turn of the century for pocket automatic pistols of Browning design, and has retained its popularity to the present. The full metal jacketed bullet can range in weight from 4.6 to 5.0 grams, and the velocity from 275 to 366 m/s, depending on the manufacturer. Practical range does not exceed 15 meters. This cartridge has been produced by numerous manufacturers in many countries; over the years automatic pistols and even revolvers of many makes, as well as the Czechoslovak "Skorpion" machine pistol, have been designed to fire this cartridge. Aside from this latter weapon, the cartridge has found military application in many pistols, including the Czechoslovak Vz 50 and Vz 70, North Korean Type 64 and Japanese Model 57B pistols.

Index No. 4

9x17

Other Designations: 9-mm Browning Short; 9-mm  
Corto; 9-mm Kurz; .380 ACP;  
.380 Automatic; 9-mm M34.

★The 9x17 cartridge was introduced in Europe in 1908 as the 9-mm Browning Short and in the United States as the .380 ACP. The full metal jacketed bullet weighs approximately 6.2 grams. Muzzle velocity varies from 275 to 310 m/s, depending on the manufacturer. Practical range is 15 to 25 meters. In addition to widespread use in police and self-defense weapons, this cartridge has been used in military pistols, notably by Czechoslovakia in the Vz 64 machine pistol, by Spain, and by Italy in the Model 1934 Beretta pistols.

Index No. 5

9x18

Other Designations: 9-mm Makarov; 9-mm PM;  
Type 59; 9-mm Police.

This cartridge was introduced in the Soviet Union shortly after the close of World War II as a replacement for the 7.62x25 pistol and submachine-gun cartridge. It appears to be a development of the 9-mm Ultra, developed in Germany in 1936 but dropped soon afterward. Muzzle velocity of the 7.62-gram bullet ranges from 310 to 340 m/s. Practical range of the pistol is approximately 25 meters; of the machine pistol, 40 meters. The full metal jacketed bullet had a lead core until the mid-1960s, when a mushroom-shaped mild steel core was substituted. The 9x18 cartridge is used in the Soviet Makarov (PM) pistol; in an East German version, the Pistole M; and in a Chinese version, the Type 59 pistol. This cartridge is also used in the Polish P-64 pistol, the Soviet Stechkin machine pistol, and the Polish Wz 63 machine pistol. The 9x18 Makarov cartridge is known to be made in the USSR, Poland, East Germany, and China. A similar but not identical 9x18 cartridge, with a case very similar in dimensions to that of the Soviet cartridge, is now produced in Austria by Hirtenberger Patronenfabrik, as the 9-mm Police. This cartridge, which has a flat-nose, full metal jacketed bullet weighing 6.4 grams and a muzzle velocity of 312 m/s, is designed for use in a Walther automatic pistol but can be fired in the ECC weapons. This cartridge can be identified by the 9-mm Police designation in the headstamp.



Index No. 6

9x19

Other Designations: 9-mm Parabellum; 9-mm Para;  
Pistolenpatrone 08; Pistolen-  
patrone 1941; 9-mm Luger;  
9-mm m/34; 9-mm m/39; 9-mm M38.

The 9x19 cartridge was introduced in 1904 by DWM of Karlsruhe for use in a Luger automatic pistol. The German Army adopted the pistol and cartridge in 1908, giving both the 08 designation. The term "Parabellum" (abbreviated "Para") is for "prepare for war" or "protect against war"; this is the registered trade name for pistols, carbines, and machineguns manufactured by DWM, which has become associated over the years with the 9x19 cartridge as well as the 7.65x22 cartridge. The 9x19 cartridge has been produced in a variety of bullet weights and propellant loadings. The full metal jacketed service bullet with lead core may vary in weight from 5.75 to 8.9 grams; the muzzle velocity ranges from 345 to 375 m/s in pistols and up to 450 m/s in submachineguns, depending on the loading and the weapon in which the bullet is fired. Practical ranges are 25 to 50 meters when fired from a pistol and 75 to 100 meters from a submachinegun. During World War II, bullets with mild steel cores were made by Germany; tracer bullets have been produced by a number of countries, including France, Israel, and Finland. A variety of special-purpose loads, including target, training, signal, and blank cartridges have been produced in one country or another over the years. Two variant types of 9x19 service cartridges exist. The 9x19 cartridge, developed by Italy for the Glisenti Model 1910 automatic pistol and also used in other makes and models, has a third less propellant than the standard loading and may not operate automatic weapons designed for the full load. This cartridge can be

identified by the designation "9-mm Glisenti" in the headstamp marking. The second variant is a DWM-developed 9-mm Luger carbine cartridge. Identified by its blackened cartridge case and the headstamped code number 480D, this cartridge develops a high pressure that may damage a pistol or injure the shooter. Its use should be restricted to weapons for which it is designed.

★The 9x19 is considered to be the most widely distributed military cartridge in use. It has been made by almost every country with cartridge-production capability, with the exception of the Soviet Union. Pistols using this cartridge include the Belgian FN High Power, UK Model L9A1, Czechoslovak Vz 68 and 75, French MAS Model 50 and MAB P15, Hungarian Tokagyt, Italian Beretta M1951, Japanese Model 57A, Swiss SIG Models 49 and 75, West German P1, H&K P9 and VP-70, and the Yugoslav Model 65. Submachineguns include the Austrian Steyr Model 69, Czechoslovak Vz 23 and 25, four models of the Danish Madsen, French MAT Model 49, West German MP 38 and 40, Israeli UZI, Italian Beretta M-38 series and Model 12, Romanian Model 1941, UK STEN and L2 models, West German H&K MP 5 and Walther Models MP-K and MP-L, and the Swedish Model 45b.

Index No. 7

11.43x19R

Other Designation: .455 Webley Revolver

This cartridge was adopted in 1897 by the United Kingdom for the Webley service revolvers, Marks I through VI. These revolvers and this cartridge were used in both World War I and World War II. It is now obsolete in the United Kingdom. Military loads in this cartridge have a full metal jacketed bullet weighing approximately 17 grams, fired at a

muzzle velocity of 186 m/s. Despite its low velocity, the heavy bullet is a good man-stopper at short range. Practical range for this cartridge is 25 meters.

This cartridge was developed from the .455 Enfield Mark I cartridge, which differs in having a case 22 mm long. Under its English designation this cartridge has been made both in the United Kingdom (including Canada) and the United States. In addition to the Webley .455 service revolvers, both Colt and Smith & Wesson have in the past made revolvers chambered for this cartridge.

Index No. 8

7.65x20

Other Designations: 7.65-mm French Long;  
7.65-mm French Pistol;  
7.65 L pour Pistolet,  
7.65-mm MAS.

This cartridge was introduced in 1935 for the 1935A and M1935S automatic pistols adopted by the French Army. The French Model 1938 submachinegun also fires this cartridge. The cartridge itself is very close to the .30 caliber cartridge developed by the United States in 1918 for the "Pedersen device," which made possible semiautomatic assault fire with the M1903 Springfield rifle using short-range pistol cartridges. The two cartridges can be readily distinguished by the French-style headstamp marking on the 7.65x20, which differs from the US headstamp on the .30 Pedersen cartridge. The full metal patched bullet weighs approximately 5.6 grams and has a muzzle velocity of about 360 m/s. Practical range is 25 meters for the pistol and 40 meters for

the submachinegun. In performance the 7.65x20 cartridge falls between the 7.65x17SR and the 9x19 cartridge. Although replaced in 1950 for military use by the 9x19 cartridge, this cartridge may still be found in use for police and paramilitary purposes.

Index No. 9

9x20SR

Other Designations: 9-mm Browning Long;  
9-mm Swedish Model 07.

This cartridge was designed by John M. Browning for the M1903 military automatic pistol, which was produced by Fabrique Nationale of Belgium and adopted by Sweden as the M 07 pistol. It remained in service until about 1940, when it was replaced by the 9x19 cartridge in the M1940 Swedish pistol. This cartridge was also used in other models of pistols and submachineguns, but it is now obsolete for military purposes. With a full metal jacketed bullet weighing approximately 7 grams and a muzzle velocity of about 335 m/s, the cartridge is not quite the equal of the more widely-known 9x19 Parabellum cartridge. Its practical range is about the same: 25 to 50 meters from a pistol and 75 to 100 meters from a submachinegun.

Index No. 10

9x20R

Other Designations: .38 S&W; .38 Colt New Police;  
.38 Super Police; .380/200.

This cartridge was designed by Smith & Wesson around 1877 for a pocket revolver for self-defense; it was adopted by the United Kingdom as a military cartridge prior to World War II, and it will accordingly be found in military as well as commercial

loadings. With a bullet weight (military Mark II) of 12.96 grams and a muzzle velocity of 180 m/s, this cartridge has a practical range of about 25 meters. Aside from the Smith & Wesson and Webley & Scott revolvers, many other US and foreign revolvers have been made to fire this moderate-energy but quite popular cartridge. The Webley & Scott revolver has been replaced in the United Kingdom as a military weapon by the Browning High Power automatic pistol, firing the 9x19 cartridge.

Index No. 11

7.65x21

**Other Designations:** 7.65-mm Mannlicher and M1901 and M1915; 7.65-mm Mannlicher Automatic.

Developed for the Models 1900 and 1901 Mannlicher automatic pistols, this cartridge was moderately well known in Europe before World War II. Pistols for this cartridge were made in Spain as well as Austria, and became popular in some South American countries. Although the guns and cartridges are now practically obsolete, the cartridge is included here because of its similarity to other service cartridges. With a bullet weight of approximately 5.5 grams and a muzzle velocity of 312 m/s, this cartridge has a practical range of 25 to 50 meters.

Index No. 12

8x21

**Other Designation:** 8-mm Nambu.

This cartridge was adopted in 1914 by the Japanese Army for the Type 14 Nambu automatic pistol. It was also used in the Type 94 pistol and Type 100 submachinegun. Except for a very limited postwar production in Japan and the United States, this cartridge was made only until 1945, and only in Japan. Cartridges made up to 1945 have no headstamp; some made in Japan in 1961 are headstamped J-AOA with a date of 61. Procurement in 1962 is also reported.

The 6.6-gram full metal jacketed bullet has a muzzle velocity of 325 m/s in a pistol; its practical range is 25 meters in a pistol and 50 meters in a submachinegun. Guns and cartridges are now obsolete.

Index No. 13

7.65x22

**Other Designations:** 7.65-mm Parabellum-Pistole; 7.65-mm Luger; .30 Luger.

This cartridge was introduced in 1900 by Deutsche Waffen und Munitionsfabriken of Karlsruhe for the newly-developed Luger automatic pistol; the pistol and cartridge were adopted for service use by Switzerland in 1903. The term "Parabellum" is, as has been noted, DWM's trade name for its weapons. The Spanish Llama automatic pistol has been chambered for this cartridge, as have some types of submachineguns. Cartridges of this caliber made for the DWM Parabellum Carbine have a heavier load than do pistol cartridges; the carbine cartridges are identified by a blackened case and—if made by DWM—generally by the case number "471A" in the headstamp.

This pistol cartridge has a bullet weighing approximately 6 grams with a muzzle velocity of about 370 m/s; in addition to full metal jacketed bullets, soft-nosed bullets have been produced for hunting. The practical range of the pistol is 25 meters; of the carbine, 100 meters. While obsolete as a military cartridge, it is still produced for self-defense and sporting purposes.

DST-1160G-514-81-VOL 1  
11 September 1981

Index No. 14

9x22R

Other Designation: 9-mm Japanese Revolver, Type 26.

This cartridge was introduced for the Japanese Army Type 26 (1893) service revolver, which remained in use to the end of World War II. The cartridge is notable for the extreme thinness of the cartridge rim—approximately 0.6 mm. These cartridges were made only in Japan; none has been found with a headstamp.

With a lead bullet weighing approximately 9.7 grams, fired at a muzzle velocity of 195 m/s, the 9x22R is a close counterpart of the 9x20R; like the latter, it has a practical range of 25 meters. This gun and cartridge are now obsolete.

Index No. 15

7.5x22.5R

Other Designations:

This cartridge was introduced for the Model 1882 Nagant-type Swiss Army revolver, which remained in service with some army elements even after adoption in 1903 of the 7.65-mm Luger pistol. Although obsolete for military use, the cartridge is still manufactured in Switzerland. Several types of bullets have been made for this cartridge, ranging in weight from 6.6 to 7.1 grams and with a muzzle velocity of about 220 m/s. Practical range of this cartridge is about 20 meters. This cartridge is dimensionally similar to, and is interchangeable with, cartridges for the 7.5x22.5R Norwegian and Swedish Nagant revolvers; the cartridge's origin can, however, be determined from the difference in headstamps.

Index No. 16

9x23

Other Designations: 9-mm Largo; 9-mm Bayard; 9-mm Bayard Long; 9-mm Bergmann-Bayard;  
9-mm Astra m/1921.

This cartridge was introduced in 1903 for the Bergmann Automatic pistol, (manufactured in Belgium as the Bergmann-Bayard), which was adopted by the Danish Army as a service pistol in 1910. The Spanish-made Astra m/1921, Star Model A, Super Star pistols, and Model Z45 submachineguns all use this cartridge, under the 9-mm Largo (=Long) designation. With a bullet weight of from 8.0 to 8.9 grams and a muzzle velocity of 360 m/s, this cartridge has a practical range in a pistol of 25 meters; in a submachinegun, perhaps 50 meters. Except in Spain, this cartridge is now obsolete for military purposes.

A cartridge very similar in dimensions to the Bergman-Bayard cartridge was used in the Steyr M1911 automatic pistol, which was adopted as a service weapon by Austria-Hungary in 1911 and by Romania in 1913. The rim of the Steyr cartridge is approximately 0.3 mm less in diameter, and the bullet weight is about 7.65 grams. This cartridge is also obsolete as a military cartridge. The two cartridges are quite similar in performance.

Index No. 17

9x23SR

Other Designations: .38 ACP; .38 Super Automatic.

The designation .38 ACP is not to be confused with the .380 ACP designation of the 9x17 Browning Short cartridge; the two cartridges are quite different. The 9x23SR was not developed as a metric-designation cartridge; it was introduced in 1900 by Colt for their Browning-designed .38 automatic pistol. In addition to Colt, pistols chambered for this cartridge were made by Webley & Scott. The 9x23SR cartridge has approximately the same characteristics as the 9x19 Luger cartridge. In 1929, a higher-velocity load using the same cartridge case was introduced as the .38 Colt Super Automatic cartridge, and headstamps may be found with this designation. Llama, Star, and Astra automatic pistols have been made for this cartridge.

Index No. 18

11.43x23

Other Designations: Cal. .45, Model 1911; .45 ACP;  
.45 Automatic; .450 Automatic;  
11.25-mm Norwegian Colt;  
11.25-mm Model 14.

This cartridge was developed by John M. Browning in 1905 and adopted by the US Government for the Model 1911 Colt automatic pistol designed by Browning. In 1914, Norway adopted the pistol and cartridge under the 11.25-mm designation. Argentina has used this cartridge in Colt-type automatic pistols and in the Ballester-Molina and HALCON submachineguns; Mexico in the Obregon pistol; and Brazil in the Model INA 953 submachinegun. In addition to the Model 1911 pistol, the following US military weapons have been chambered for this



cartridge: Colt and Smith & Wesson Model 1917 revolvers; Thompson submachineguns, Models 1928 and 1928A1; Reising Models 50, 55, and 60 semiautomatic guns; M1, M1A1, M3 and M3A1 submachineguns; and even a single-shot pistol with a stamped sheet steel receiver intended to be parachuted into occupied countries for use by resistance movements. Commercial pistols chambered for this cartridge have been made in Spain. The 11.43x23 (.45 ACP) cartridge is notable both for its stopping power (it is the most powerful military pistol cartridge in use today) and for its accuracy in the hands of a well-trained shooter. With a bullet weight of over 15 grams a muzzle velocity of 260 m/s, this cartridge has a practical range in a pistol of 25 meters, and in a submachinegun of 50 meters or greater. This cartridge has also been made with a tracer bullet, which is identified by the red bullet tip and, for identification by touch in darkness, by a cross impressed in the bullet tip.

Index No. 19

11.43x23R

Other Designation: .45 Auto Rim.

Never a US military cartridge, this rimmed version of the 11.43x23 cartridge was introduced in the United States after World War I for police and hunting use in Colt and Smith & Wesson Model 1917 revolvers; its purpose was to eliminate the inconvenience of the half-moon steel slips that enabled the rimless automatic pistol cartridges to be ejected from the revolver cylinder. Other than in case design this cartridge is identical to the Model 1911 ball cartridge. This cartridge has been manufactured by Brazil for military use.

Index No. 20

11.43x23.5SR

Other Designation: .455 Webley Automatic.

This cartridge was adopted by the British Navy in 1913 for the .455 Webley automatic pistol. The cartridge, a counterpart of the US Model 1911 cartridge, proved more durable than the pistol, which was soon replaced by the Model 1911 Colt automatic pistol, chambered for the British cartridge. In performance this cartridge is similar to the .45 ACP cartridge, except for a somewhat lower velocity. This cartridge is obsolete in the UK service.

Index No. 21

7.62x25

Other Designations: 7.63-mm Mannlicher, Model 1896 or 1903; 7.65-mm Mannlicher Carbine, M1896 or 1901; 7.65-mm Borchardt; .30 Mauser Pistol; 7.63-mm Mauser Pistol; 7.62-mm Type P; 7.62-mm Type 50; 7.62-mm Tokarev, M. 30.

★This durable cartridge first appeared in 1893 for the Borchardt self-loading pistol that was the design forerunner of the Luger pistol. With only minor changes in bullet weight and propellant loading, this cartridge was also used in the Models 1896, 1901, and 1903 Mannlicher pistols and pistol-carbines. The same cartridge case but with a distinctly heavier load was developed for the 7.63-mm Mauser Model 1896 military automatic pistol, which earned a worldwide reputation. In 1930, the Soviet Union adopted the Mauser cartridge, under the designation 7.62-mm Type P, for the Tokarev TT-30 and TT-33 automatic pistols and later

20 August 1984

for the Models PPD-40, PPSH-41, and PPS-43 sub-machineguns. Although no longer used by Soviet military forces, these weapons are found in eastern Europe and worldwide. Other military weapons that fire this cartridge are the German Model 1932 machine pistol; PRC Types 51 and 54 pistols and Types 50 and 64 submachineguns; Czechoslovak Models 24 and 26 submachineguns and Model 52 pistol; Polish Model 1943/52 submachinegun; North Korean Type 68 pistol; Hungarian Model 48 sub-machinegun; Yugoslav M49, M49/57 and M56 submachineguns and Spanish Astra Models 900 and 903 pistols.

Besides ball cartridges, API and tracer cartridges have been made by the Soviet Union for submachinegun use. The muzzle velocity of the 7.62x25 is 400 m/s in the pistol and 450 m/s in the submachinegun. its practical range in a pistol is 25 to 30 meters; in a submachinegun, 100 to 150 meters; and in a pistol-carbine, about 200 meters. Although obsolescent as a military cartridge, the 7.62x25 is still available commercially for police and sporting use.

Index No. 22

9x25

Other Designations: 9-mm Mauser Pistol;  
9-mm Mauser, Export Model,  
9.08x25, Kal. 9 Mauser.

Reported to be the most powerful pistol cartridge ever developed in Europe, this cartridge was designed for the Mauser Model 1908 automatic pistol. The Swiss "SIG" and Hungarian Models 39M and 43M submachineguns were also chambered for this cartridge. It has been obsolete for military use since the end of World War II. With a metal-jacketed bullet weighing up to 9 grams and a muzzle

velocity of over 400 m/s, this cartridge has a practical range in a pistol of up to 30 meters and a submachinegun of up to 60 meters.

Index No. 23

8x27R

Other Designations: 8-mm Lebel Revolver;  
8-mm Revolver M 1892;  
8.3x27, 5-mm Lebel Revolver.

★ Adopted in 1886 but used chiefly in the French Lebel service revolver Model 1892, this cartridge was generally replaced in the French military service before World War II by the 7.65x20 MAS cartridge. With a bullet weight of up to 9.6 grams and a muzzle velocity of 260 m/s, this only moderately powerful cartridge has a practical range of 25 meters. Other revolvers chambered for this cartridge were made for commercial sale, among them the Belgian-made Pieper and Bayard.

Index No. 24

9x29R

Other Designations: .38 Special; .38 S&W Special;  
.38 Colt Special.

Under the designation ".38 Special," this cartridge was introduced in 1902 by Smith & Wesson as an improved military cartridge to replace the .38 Long Colt cartridge. Although never adopted by the United States as a regulation military cartridge, this cartridge has been widely used for three quarters of a century for police, guard, personal protection, and competition use. Bullet weights may range from 6.5 to 13 grams, but weights of 9.6 to 10.2 grams and muzzle velocities of 260 to

325 m/s are more common. A variety of special-purpose bullets are made for police, hunting, and target use. The cartridge has been widely adopted by foreign countries for guard and police purposes.

The 9x29R cartridge is noted for its accuracy; this, with its moderate recoil, gives it a practical range in a revolver of perhaps 35 meters. In addition to revolvers, both Smith & Wesson and Colt have made automatic pistols that fire this cartridge. Foreign manufacturers in Germany, Belgium, and Spain have made revolvers that fire this still-popular cartridge.

Index No. 25

7.62x33

Other Designations: .30 Carbine; .30 M1 Carbine;  
K7.62.

Introduced in 1941 for the Winchester-designed semiautomatic M1 carbine, this cartridge is nearly identical to the cartridge developed in 1906 for Winchester's .32 caliber self-loading rifle, a cartridge that by 1920 had become obsolete for sporting purposes because of its weak performance. With a bullet weight of 7.2 grams and a muzzle velocity of 580 m/s, this cartridge has a practical range of about 150 meters; although the carbine sights are graduated for ranges up to 300 yards, its remaining energy at ranges over 150 meters is not impressive. Tracer as well as ball cartridges have been produced.

Aside from its use in various models of semiautomatic and automatic US carbines and their Japanese counterparts, at least one commercial handgun has been chambered for this cartridge. Although still in limited use in foreign countries, it is obsolescent as a military cartridge.

Index No. 26

7.92x33

Other Designations: 7.92x33 Kurz; PP 43.

★Developed by Germany in 1941-1942, and thus a contemporary of the US 7.62x33 cartridge, the 7.92x33 is essentially a shortened 7.92x57 Mauser cartridge using a lighter bullet and is intended for full-automatic fire at short to medium ranges in the MP-43 and 44 assault rifles. With a bullet weight of 8.1 grams and a muzzle velocity of 700 m/s, the practical range of 300 meters is limited by the full-automatic fire mode of the assault rifles. The guns and cartridge have been obsolete since the end of World War II, except in East Germany, where cartridge and assault guns (designated Kz 43) have been produced.

Index No. 26a

5.45x39

Other Designations: 5.45-mm AK-74; AKS-74; RPK-74.

Introduced by the USSR in 1974 for use in the AK-74 and AKS-74 assault rifles and the RPK-74 light machinegun, this cartridge has a low-drag bullet design that provides better performance than the 7.62x39 cartridge. Ball and tracer types are known. Bullet weight is approximately 3.4 grams. Muzzle velocity in the assault rifle is 900 m/s and in the light machinegun, 960 m/s. Practical range in the assault rifle is 400 to 500 meters; in the RPK-74 light machinegun, the effective range is approximately 800 meters.

Index No. 27

5.6x39

Other Designation: 5.6 "Running Deer" cartridge.

Although not in use as a military cartridge, this cartridge is included because it exists in a full metal jacketed, spitzer bullet version of military type for competition firing.

The 5.6x39 cartridge is based on the 7.62x39 case, necked down to take a 5.6-mm bullet. It was developed in the USSR in the 1950s for small-game hunting and for competition firing at a range of 100 meters on the "Running Deer" target. The cartridges have also been made in Finland by Lapua and Sako. With a bullet weight of 2.8 grams and a muzzle velocity of 1030 to 1060 m/s, this is a satisfactory cartridge for 200- to 250-meter target shooting and, with a soft-nose bullet, for small game hunting. No military application of this cartridge is reported.

Index No. 28

7.62x39

Other Designations: 7.62-mm Soviet short; 7.62-mm M 43; 7.62-mm Type 56; 7.62-mm Model 60.

The 7.62x39 cartridge was introduced in 1943 by the USSR as a counter-threat to the German 7.92x33 assault rifle cartridge. With a bullet weight of approximately 8 grams and a muzzle velocity of 715 m/s, it has somewhat more energy at short and medium ranges than the German cartridge. Depending on the type of weapon in which used, the cartridge has a practical range of 300 meters in the AKM assault rifle and an effective range of 800 meters in the RPK light machinegun. The 7.62x39 is still a standard infantry cartridge of the ECC; weapons

chambered for this cartridge include the Soviet SKS carbine, AK-47 and AKM assault rifles, and Models RPD and RPK light machineguns; the Czechoslovak Model 52/57 rifle, Model 58 P and 58 V assault rifles, and Model 52/57 light machinegun; the East German MPiK and MPiKM assault rifles and LMGD and LMGK light machineguns; the Polish PKM assault rifle; the Finnish M60 and M62 assault rifles and M60 light machinegun; the Yugoslav M59 and M59/66 rifles and M56 assault rifle; the Egyptian "Rashid" rifle; and the Chinese Type 56 carbine, assault rifle, and light machinegun. The 7.62x39 cartridge has been produced throughout the ECC and in some countries of the free world as well. In addition to ball cartridges, API, tracer, and I-T types have been made.

Index No. 29

7.62x39R

Other Designations: 7.62-mm Nagant revolver;  
7.62-mm Russian revolver.

This cartridge was used in the Belgian-designed Nagant revolver, which was adopted by the Czar's Army in 1895. The cartridge is unusual in that the bullet is contained entirely within the case mouth. This construction is demanded by the design of the Nagant revolver cylinder, which moves forward when the revolver is cocked, so that the mouth of the chamber fits over the rear of the barrel while the case mouth extends slightly into the barrel to avoid escape of gas at the junction of cylinder and barrel. Replaced in service in the USSR in 1930 by the 7.62-mm TT-30 pistol, this gun and cartridge were used during the Korean War; they are still used to some extent for target shooting. Both the cartridge and revolvers chambered to accept it have also been produced outside the USSR. The lead



DST-1160G-514-81-VOL 1-CHG 1  
20 August 1984

bullet weighs in the vicinity of 7 grams and has a muzzle velocity of 290 m/s. The gun has a practical range of perhaps 25 meters.

Index No. 30

5.56x45

Other Designations: 2.23 Remington; 5.6x45.

★The world's first adopted service cartridge with a caliber below 6 mm, this cartridge was developed by Remington in the mid-1950s and introduced into the US service a decade later for use in the AR-15 and M16 assault rifles. The cartridge has recently been adopted by NATO as a standard caliber, in addition to the 7.62x51 cartridge. The US M193 ball bullet, with a weight of 3.56 grams, has a muzzle velocity of 990 m/s and a practical range of about 300 meters. Improved performance at longer ranges can be achieved by use of a heavier bullet with better ballistic characteristics, such as Fabrique Nationale's SS-109 bullet (US Designation M855); this bullet, however, requires a faster rifling pitch for proper performance than does the M193 projectile. Rifles and light machineguns firing the 5.56x45 cartridge include the Austrian Sturmgewehr (assault rifle) 77, Belgian C.A.L. and FNC, French F.A.M.A.S., Israeli Galil, Italian Beretta M70, and the West German HK13, HK21, and HK21A1. Cartridges are made in many free world, Eurasian Communist, and Third World countries.

Index No. 31

7.62x45

Other Designations: 7.62-mm Czechoslovak Short;  
7.62-mm M52.

This cartridge was developed by Czechoslovakia after World War II and went into production in 1950. Like the Soviet 7.62x39, its design was evidently inspired by the German 7.92x33 assault rifle cartridge. With a bullet weight of 8.54 grams and a muzzle velocity of 750 m/s, this cartridge outperforms the Soviet 7.62x39 cartridge; its practical range should be slightly greater. The 7.62x45 cartridge was used in the Czechoslovak Model 52 rifle and light machinegun, but its use was short-lived, as Czechoslovakia soon afterwards (in 1957) modified its weapons to accept the 7.62x39 cartridge. Both ball and tracer types are known. Never made elsewhere than in Czechoslovakia, the cartridge has been obsolete for many years. Closely resembling the 7.62x45 cartridge, and easily confused with it, is a trial 7.5x45-mm cartridge made in 1947 to 1949 for the Model ZK-472 semiautomatic rifle that never reached mass production. The 7.5-mm cartridge has a bullet diameter of 7.6 mm and a cartridge case that is 0.5 mm smaller in diameter than the M52 case.

Index No. 32

4.85x49

Other Designation: 4.85-mm UK Assault Rifle.

Introduced by the United Kingdom for field trials, this is the smallest caliber military cartridge to date that has been developed beyond the experimental state. The cartridge case is evidently derived from the 5.56x45 case, necked down to 4.85 mm; the neck is lengthened to provide a seat for the long bullet. Bullet weight is approximately 3.25 grams; muzzle velocity ranges from 900 m/s in the assault rifle to 930 m/s in the light support weapon. The high sectional density of the bullet is intended to provide increased range and lethality over that of the 5.6x45 cartridge. Practical range is estimated to be perhaps 350 meters. Ball and tracer cartridges are reported. The only weapons chambered for this trial cartridge are made by the United Kingdom.

Index No. 33

6.5x50.5SR

Other Designations: 6.5-mm Japanese; 6.5-mm Arisaka.

This Japanese-developed cartridge, which first appeared in 1897, is best known for its use in the Model 38 (1905) Arisaka rifle and carbine and the Nambu machinegun. Although largely replaced by the 7.7x58 cartridge, 6.5-mm guns and ammunition continued in service through World War II; Chinese and North Korean troops used them in the Korean War. The long, round-nosed bullet, which weighs 9 grams, has a cupronickel jacket and lead core and is fired at a muzzle velocity of about 760 m/s. The relatively heavy bullet gives this cartridge a practical range of up to 400 meters. Although obsolete as a military cartridge, cartridges in this caliber for hunting are reported to be produced by Norma A/S of Sweden and can be identified by the headstamp. Japanese military cartridges in this caliber have no headstamp; some, however, were produced in Japan for Thailand with a Thai marking. The PRC also produced this cartridge in 1949-1951.

Index No. 34

8x50.5R (Lebel)

Other Designation: 8-mm Lebel.

Introduced by France in 1886 for the Lebel bolt-action rifle, this is the first high-velocity, small-caliber (under 10 mm) military cartridge using smokeless powder to be adopted by any major country. During World War I, automatic rifles and light and heavy machineguns firing this cartridge were produced; cartridges in this caliber have been made in many countries, including the United States and the United Kingdom, for sporting as well as military use. Although replaced in the French service in 1936 by the 7.5x54 cartridge, this 90-year-old cartridge was still in use during World War II, and has not, even now, completely disappeared from use. The 12.8-gram boat-tailed bullet (Balle D) is of solid bronze; with a muzzle velocity of about 725 m/s, it has a practical range in rifles of up to 350 meters and an effective range in machineguns of up to 1200 meters or more.

Index No. 35

8x50.5R (Steyr)

Other Designation: 8-mm Austrian Mannlicher.

Despite the similarity in caliber and case length, the case dimensions of this cartridge differ so much from those of the Lebel cartridge that they are in no way interchangeable. This cartridge, with a black powder propellant charge, was adopted by Austria-Hungary in 1888 in the Mannlicher Model 88 Straight Pull rifle; it was also used, with a smokeless powder load, in the improved Model 95 rifle and later in machineguns. This cartridge was also used by Bulgaria and Greece. This is another of the standard cartridges of World War I; it saw limited use in World War II and is now obsolete for military purposes, although sporting cartridges are still produced in this caliber.

With a bullet weight of 15.8 grams and a muzzle velocity of 620 m/s, this cartridge has a practical range in rifles of 300 meters and an effective range in machineguns of 1200 meters.

Index No. 36

7x51

This cartridge was produced about 1954 by Fabrique Nationale of Herstal, Belgium for use in a 7-mm FAL rifle produced for Venezuela. The results were not satisfactory, and FN discontinued cartridge production about 1956. The rifles were rebarreled to 7.62x51 NATO. This cartridge utilized a 7.62x51 case necked down to take a 7-mm bullet; it can be identified by the bullet diameter. The cartridge is listed in FN sales brochures; specimens are known with the FN headstamp and dates of 52 or 56. Bullet weight is 9 grams, and muzzle velocity is 790 m/s. Its performance and practical range should be about that of the 7.62x51 NATO cartridge.

Index No. 37

7.62x51

Other Designations: 7.62 NATO; .308 Winchester.

Developed in the early 1950s and adopted as the US military rifle cartridge in 1954, this is a shorter and lighter version of the 7.62x63 (.30-06) cartridge. Despite the 12-mm difference in case length and a reduced propellant capacity, this cartridge is almost, if not quite, equal to the 7.62x63. Used in the US M14 rifle and M60 machinegun, this cartridge has been adopted as NATO standard and has been produced by many NATO and non-NATO countries. Among the foreign rifles and machineguns chambered for this cartridge are the West German G-3 rifle and MG-1 and MG-3 machineguns; Belgium's MAG machinegun and its derivatives and FN's FAL series; the French AAT 52N1 machinegun and FRF-F1 sniper's rifle; UK's L-4 series machineguns and L-37 and L-42 rifles; the Italian BM-59 rifle; the Czechoslovak VZ59N machinegun; and the Swiss SIG-510 rifle (export version).

Although replaced in the United States for service rifle use by the 5.6x45, the 7.62x51 remains in use for the M60 machinegun. The 9.72-gram bullet has a muzzle velocity of 872 m/s; its practical range in the rifle is 350 meters, and its effective range in the machinegun is 1200 meters or greater.

Index No. 38

7.35x52

Other Designations: 7.35 Carcano; 7.35 Italian.

To provide a rifle and machinegun cartridge with improved performance, Italy adopted this cartridge in 1938 as a replacement for the older 6.5x52 cartridge. In the following year the deteriorating international situation caused production of the new gun and cartridge to be discontinued, and they were withdrawn from service. In performance the 7.35x52 is nearly the equal of the 7.62x51 NATO cartridge; with an 8.3-gram bullet and a muzzle velocity of 867 m/s, it has a practical range of perhaps 325 meters and an effective range of 800 meters. Weapons chambered for this cartridge include the Model 38 rifle and carbine and the Breda Model 38 light machinegun. Although used by Finland in the 1939 Russo-Finnish War, it was not used to any extent in World War II and is obsolete as a military cartridge. Many weapons were sold as post-war surplus in the United States. The cartridge is not currently made in either military or sporting loadings.

Index No. 39

8x52R

Other Designations: 8-mm Type 66; 8-mm Siamese.

The Type 66 cartridge was introduced in 1923, replacing the Type 45 8x50R cartridge, which had been in use since 1902. With a bullet weight of 11.7 grams and an estimated muzzle velocity of 725 m/s, performance of this cartridge is only moderate. Its practical range is approximately 300 meters in rifles, and its effective range is perhaps 1100 meters in machineguns. This cartridge was used in Mauser-type rifles made at Tokyo Arsenal, in Mannlicher Model 95 straight-pull rifles, and in Madsen machineguns. The cartridge and guns have been obsolete since the end of World War II.

Index No. 40

6.5x52.5

Other Designations: 6.5 Italian; 6.5 Mannlicher-Carcano.

This cartridge and Index Nos. 41 and 43 are quite similar in case dimensions and in performance. The 6.5x52.5 cartridge was the first to appear; it was adopted in 1891 by the Italian Army for use in the bolt-action Mannlicher-Carcano rifle and carbine, and it remained in service through World War II. With a round-nosed, jacketed bullet weighing 10.5 grams and a muzzle velocity of 700 m/s, this cartridge has a practical range of about 350 meters and an effective range of 800 to 900 meters. In addition to the rifle and carbine, this cartridge was also used in the Breda Model 30 light machinegun and the Fiat-Revelli Model 1914 heavy machinegun. Prior to 1940, sporting cartridges were available in this caliber. It has been obsolete as a military cartridge since the close of World War II but has seen some use (with soft-point bullets) as a sporting cartridge in war-surplus arms.

DST-1160G-514-81-VOL 1  
11 September 1981

Index No. 41

6.5x53.5

Other Designations: 6.5-mm Greek Mannlicher; 6.5-mm Mannlicher-Schoenauer.

Introduced by Greece for use in the Model 1903 Mannlicher bolt-action rifle, this cartridge differs only slightly in its case dimensions and configuration from the 6.5x52.5 Mannlicher-Carcano cartridge, Index No. 40; identification can usually be established from the headstamp markings. This cartridge also has a round-nosed jacketed bullet that weighs 10.5 grams; at 715 m/s its muzzle velocity is a bit higher than that of the preceding cartridge. The performance of the two cartridges is about the same. Although now obsolete, military cartridges in this caliber were manufactured by Fabrique Nationale in Belgium as recently as 1950, and sporting cartridges are still manufactured in Europe.

Index No. 42

7.65x53.5

Other Designation: 7.65 Mauser.

Another "durable" cartridge, the 7.65x53.5 was developed by Mauser for the Belgian Model 1889 rifle; Mauser rifles in this caliber were widely adopted in South America and by Turkey. Early bullet design called for a round-nosed jacketed bullet weighing 11.25 grams and a muzzle velocity of 725 m/s; by 1940, this bullet had been replaced by a boat-tailed, pointed, spitzer-type bullet of the same weight with improved ballistic characteristics. A lighter, flat-based bullet has also been made by FN; it has a 10-gram bullet traveling at a muzzle velocity of 830 m/s. With these bullets the 7.65x53.5 cartridge is in a class with the 7.62x51 NATO cartridge. Although no longer used by Belgium or Turkey, the 7.65x53.5 cartridge remains in service in Argentina, Bolivia, Colombia, and Ecuador. In addition to ball cartridges, bullet types include AP, incendiary, tracer, and observation. A potential hazard exists in handling the Argentine observation cartridge, Type R, since the bullet contains an HE filler. The bullet can be recognized by its black tip and by a slight rattle that can be heard when the cartridge is gently shaken. Over a dozen models of Mauser bolt-action rifles have been chambered for the 7.65x53.5 cartridge.

Machineguns include FN's Browning Automatic Rifle, Model 30, and Browning heavy machinegun, as well as the Madsen machinegun, Models M28, M31, and M35. Military and sporting cartridges are still available in this caliber.

Index No. 43

6.5x54R

Other Designations: 6.5-mm Dutch Mannlicher; 6.5-mm Romanian Mannlicher.

Introduced in 1892 for the Dutch and Romanian Model 1892 Mannlicher rifles, this cartridge is identical to the 6.5x53.5 Greek Mannlicher cartridge except for the rimmed case. Bullet weights and types, muzzle velocity, and performance characteristics are similar to those of the Greek Mannlicher cartridge. Although obsolete in both countries as a military cartridge since the close of World War II, commercial sporting ammunition is still manufactured in Europe.



DST-1160G-514-81-VOL 1  
11 September 1981

Index No. 46

6.5x55

Other Designations: 6.5-mm Norwegian Krag; 6.5-mm Swedish Mauser.

Adopted by Sweden in 1894, this cartridge was used in Swedish Mauser rifles and carbines, Models 94, 96, and 38. The same cartridge was adopted by Norway for the Model 1894 and 1912 Krag-Jorgensen rifles. The military cartridge originally had a heavy, round-nosed jacketed bullet that weighed approximately 10 grams and traveled at a muzzle velocity of 720 m/s. This cartridge has a practical range in rifles of about 350 meters and an effective range of 1200 meters.

In later years both countries improved cartridge performance by changing to a boat-tailed, ogival (pointed) jacketed bullet weighing approximately 9 grams and fired at a muzzle velocity of 800 m/s.

In addition to ball ammunition, Sweden has also produced tracer and AP cartridges in this caliber. This cartridge is extremely accurate, and is still widely used for hunting and target shooting. It has been produced in Finland and other countries, as well as in Norway and Sweden. As a military cartridge, however, it has been obsolete since the close of World War II.

In addition to the aforementioned rifles, the following Swedish weapons fired this cartridge: Model 42 series (Ljungmann) rifles; Models 21 and 37 Browning automatic rifles; Browning heavy machinegun; and Browning Model 42 machinegun.

Index No. 47

7.5x55.5

Other Designations: 7.5-mm Swiss; 7.5-mm Schmidt-Rubin; 7.54 mm.

Introduced in 1889 for the Swiss Schmidt-Rubin straight-pull, bolt-action rifle, this cartridge originally had a paper-patched, round-nosed lead bullet that weighed 13.6 grams and had a muzzle velocity of only 600 m/s. Improved bullets and propellants were developed as stronger rifle actions were introduced, culminating in the Model 1911 cartridge, which has a boat-tailed, pointed spitzer-type bullet that weighs 11.3 grams and has a muzzle velocity of 780 m/s. Because of its more powerful loading and slightly larger bullet diameter, the Model 1911 cartridge should not be fired in Model 1889 rifles. In its range and effectiveness the 7.5x55.5 cartridge is equal to the 7.62x51-mm NATO cartridge. Despite its caliber designation the Model 1911 bullet, like the 7.5x54 French bullet and the 7.62x51 NATO bullet, measures 7.8 mm in diameter. In addition to service ball cartridges, tracer, AP, and competition firing loadings exist. The Swiss use or have used this cartridge in the following weapons, in addition to the Model 1889 rifle: Model 1911 carbines and rifles; Model 1931 carbine and rifle; Models 31/42, 31/43, and 55 rifle; Model 57 assault rifle; Model 1925 light machinegun; Models 51, MG 710-1, and MG 710-2 machineguns; and Model 1911 heavy machinegun. This cartridge is still in use.



Index No. 48

7.7x56R

Other Designations: .303 British; .303 Enfield; 7.7 mm Japanese Type 92.

The 7.7x56R cartridge was adopted in 1888 for use in the Lee-Metford bolt-action rifle. At that time the cartridge had a 13.9-gram round-nosed jacketed bullet, a propellant charge of compressed black powder, and a muzzle velocity of 564 m/s. In 1892, the propellant was changed to cordite, which is a double-base smokeless propellant in the form of long, thin, translucent strands. In 1914, the bullet shape was changed to a long, pointed, jacketed bullet with an aluminum (or fiber) nose filler ahead of the lead filler. This bullet, the Mark 7, has remained in use ever since. A variety of other bullet types have been used, including tracer, AP, and incendiary. During World War II, nitrocellulose propellants were also used; cartridges with this propellant can be identified by the letter Z added to the bullet designation in the headstamp marking. The 7.7x56R cartridge remained in service in the United Kingdom until 1957, and it is still to be found in service on the borders of the former British empire. In performance it is very close to the 7.62x51 NATO cartridge that replaced it. The Lee-Metford rifle was replaced in 1895 by the first of a long series of models of Lee-Enfield rifles and carbines that were chambered for this cartridge. Various models of Vickers, Lewis, Browning, Hotchkiss, and Bren machineguns were also designed or adapted to fire this cartridge. The 7.7x56R cartridge was used outside of the United Kingdom during World War II; Italy used this cartridge in the Breda aircraft machinegun, and the Japanese Navy in Type 92 (Lewis design) and Type 97 (Vickers design) machineguns. The Japanese loadings, which can be recognized by the headstamp, include a high-explosive bullet that contains a PETN charge. This bullet, identifiable by its blunt nose and a purple primer seal, must be considered as very hazardous in view of its age.

Index No. 49

8x56R

Other Designations: 8-mm Hungarian Mannlicher; 8-mm Hungarian Model 31,  
8-mm Austrian Model 30.

This cartridge was developed in 1931 and adopted in 1933 by Hungary to replace the 8x50.5R (Steyr) cartridge. Although Hungary adopted the 7.92x57 Mauser cartridge in 1940, the 8x56R cartridge was used to some extent during World War II; it is now obsolete as a military cartridge, and no sporting loads are reported. With a bullet weight of about 13 grams and a muzzle velocity of 700 m/s, this cartridge has a practical range of 300 meters in rifles and an effective range of 1100 meters in machineguns. The principal weapons that chamber this cartridge are the Austrian Model 1895 carbine (rebarrelled) and Model 305 light machinegun, and the Hungarian Model 35 rifle and Model 31 light machinegun.

Index No. 50

7x57

Other Designations: 7-mm Mauser; Spanish Mauser.

This cartridge was developed by Mauser in 1892 as a smaller-caliber version of the military 7.92x57 cartridge. It was immediately adopted by Spain for use in Mauser bolt-action rifles, to replace the 11.15x58R cartridge used in single-shot Remington rifles. The 7x57's excellent ballistic qualities led to its wide acceptance, notably in South America and Mexico. As originally loaded, the 7x57 military cartridge had a round-nose jacketed bullet having a diameter of 7.19 mm and weighing 11.2 grams. Muzzle velocity was below 700 m/s. At some time in the 1900s, performance was improved by substituting a pointed spitzer-type bullet with a diameter of 7.29 mm. Military rifles were rebarreled to accept the larger-diameter bullet. Fabrique Nationale in Belgium produces this cartridge with a jacketed, pointed bullet weighing 9 grams and having a muzzle velocity of 855 m/s. Practical range is about 300 meters and effective range, 900 meters.

Hunting rifles in this caliber have generally retained the smaller bore diameter of the original 7x57 cartridge design. Use of the larger-diameter military bullets in these rifles will result in high--perhaps dangerously high--chamber pressures and should be avoided. This cartridge has been produced in Europe as a sporting cartridge, in a rimmed case version designated the 7x57R.

Index No. 51

7.92x57

Other Designations: 7.9-mm Mauser; 7.92-mm Mauser; 8-mm Mauser; 8x57 Mauser.

The original 7.92x57 cartridge, which was designed for the German Model 1888 rifle, had a round-nosed, jacketed bullet 8.1 mm in diameter and weighing 14.7 grams. Muzzle velocity was 630 m/s. When the Mannlicher-type Model 1888 rifle was replaced by the considerably more robust Mauser Model 1898-series rifles and carbines, improvements in cartridge case, propellant, and bullet were undertaken. The outcome was the appearance in 1903 of the "S" cartridge, so designated because of the "S" ("Spitzgeschoss," or "pointed bullet") bullet. This short, pointed, jacketed bullet weighed only 9.8 grams and had a muzzle velocity of 870 m/s--an extremely high velocity for a military bullet at that time. The "S" bullet was 8.22 mm in diameter; this larger diameter, with the heavier propellant loading, renders it hazardous to fire these cartridges in guns designed for the M1888 cartridge. The practical range of this cartridge is about 400 meters; its effective range is from 800 to 1400 meters, depending on the bullet used and the type of weapon in which fired. A heavier, boat-tailed bullet was used for machineguns in World War I.

This cartridge has been very popular in hunting loads as well; designated the 8x57, it is available in two versions. The 8x57 J ("J" = "I" and stands for "Infantry") cartridges, which have an 8.1-mm-diameter bullet and a moderate propellant load, are designed for guns chambered for the M1888 cartridge and are safe to fire in any serviceable 7.92x57 rifle. The 8x57 JS cartridge has the larger 8.22-mm bullet and should be used only in S-bore rifles. As was true of the 7x57 cartridge, a rimmed 7.92x57 sporting cartridge, designated the 8x56 JR, is produced in Europe. This cartridge should not be confused with the military 7.92x57R (Dutch) cartridge, Index No. 52.

In addition to numerous Mauser-pattern rifles, the following are some of the arms that are or have been chambered for this cartridge: FN semiautomatic rifle; M49 Egyptian Hakim (Ljungmann) rifle; German G-41 and G-43 rifles and MG08, MG 08/15, MG34, MG42, and FG42 machineguns and copies; Czechoslovak ZB26, ZB30, and ZB37 machineguns and copies; and Spanish ALFA M1944 and FAO machineguns.

The 7.92x57 cartridge, like the 7.7x56R and 7.62x63 cartridges, was widely used in both world wars, and has not yet disappeared from service. The cartridge has been produced in many countries; the United States produced this cartridge in quantity for Nationalist China during World War II. The ROC (and, from 1950-1952, the PRC) has also produced this cartridge. Many functional types have been made over the course of years; heavy ball, AP, tracer, incendiary, and API. During World War II Germany made an observation bullet, designated the B-Patrone, that indicated the point of impact by a flash and a white smoke puff. This cartridge contains a firing pin and a small amount of explosive. The cartridge can be identified by a black primer seal and by either a chrome-colored bullet tip or a bullet with the rear half blackened.

Also during World War II, Japan produced 7.92x57 cartridges (which have no headstamp) in ball, AP, incendiary, and HE loadings. The incendiary bullet contains WP and is recognized by a magenta band ahead of the case mouth; the HE bullet, containing PETN, has a white band ahead of the case mouth. These special-purpose bullets can inflict serious injury or death if handled injudiciously.

**Index No. 52** **7.92x57R (Dutch)**

**Other Designations:** 7.92-mm Dutch machinegun; 7.92-mm Dutch rimmed.

This cartridge case can be distinguished from a commercial 8x57 JR sporting cartridge by the unusually thick (1.6 mm) extraction rim. The cartridge will usually have a characteristic Dutch-style headstamp marking. The cartridge was adopted for use in the Models 1901 and 1908 Schwarzlose heavy machineguns; it may also have been used during World War II in some Lewis light machineguns. When adopted, the cartridge had a long, round-nosed jacketed bullet. By World War II a boat-tailed, jacketed spitzer-type bullet was standard. Ball, AP, and AP-T types are known. Practical and effective ranges are similar to those of the 7.92x57 cartridge, Index No. 51. This cartridge and its guns were used in World War II but are now obsolete.

**Index No. 53** **6.5x58**

**Other Designations:** 6.5-mm Mauser-Vergueiro; 6.5-mm Portuguese Mauser.

Used in the Mauser-Vergueiro bolt-action rifle, Model 1904, this cartridge had a long, round-nosed jacketed bullet that weighed 10 grams and had a muzzle velocity of 715 m/s. This cartridge was used until 1937, when it was replaced by the 7.92x57 Mauser rifle and cartridge. In performance it is inferior to the 7.92x57 cartridge; its practical range is about 300 meters, its effective range 750 to 800 meters. Sporting cartridges have been loaded in this caliber, but it is obsolete as a military cartridge. No military weapons other than the Mauser-Vergueiro rifle are known to have been chambered for this cartridge.

DST-1160G-514-81-VOL 1  
11 September 1981

Index No. 54

7.7x58

Other Designations: 7.7 Japanese Type 99; 7.7 Japanese rimless; 7.7x58 Arisaka.

Introduced in 1939 for use in the Japanese Army's Type 99 (Arisaka) rifle and Type 99 light machinegun, this cartridge is a rimless version of the 7.7x58 SR Type 92 heavy machinegun cartridge. Aside from having a rimless cartridge case, Type 99 cartridges differ in having flat-based bullets that are slightly lighter in weight than the boat-tailed bullets of the semirimmed Type 92 cartridges, and in having a correspondingly reduced propellant loading that provides the same muzzle velocity as the heavier cartridge—about 730 m/s. Bullet weights range from approximately 12 grams for ball bullets to 9.7 grams for AP and tracer types. Practical and effective ranges and identification color coding are the same as those given for the Type 92 cartridge, Index No. 55. Aside from the Type 99 rifle and light machinegun, this cartridge was used in the Type 97 tank machinegun and the Type 1 heavy machinegun. It is reported that Type 99 cartridges will also fire in the Type 92 heavy machinegun. Although not in use as a military cartridge today, Norma Projektfabrik of Sweden manufactures hunting cartridges in this caliber for the American market.

Index No. 55

7.7x58 SR

Other Designations: 7.7-mm Japanese Type 92; 7.7-mm Japanese semirimmed.

This cartridge was adopted in 1932 for the Type 92 heavy machinegun to provide improved performance over that of the 6.5x50.5 SR cartridge; it did not, however, replace the latter cartridge, which continued in service to the close of World War II.

The 7.7x58 SR cartridge has boat-tailed, jacketed, spitzer-type ball and AP bullets, while tracer, incendiary, and HE bullets have long, flat-based spitzer bullets. Bullet types are identified by a color band on the bullet ahead of the case mouth: pink for ball cartridges, green for tracer, black for AP, magenta for incendiary, and purple for HE. The HE bullet can be further identified by its flat tip. The incendiary bullet contains WP, and the HE bullet contains PETN; a minimum of handling and a maximum of caution are recommended. Aside from the Type 92 heavy machinegun, the semirimmed cartridge is also used in Type 89 fixed and flexible aircraft machineguns. The practical range of the 7.7x58 and 7.7x58 SR cartridges is about 350 meters; the effective range, which will vary with the type of cartridge and weapon in which used, is from 700 meters to 1200 meters. The 7.7x58 SR cartridge was made in the PRC in 1951 for use during the Korean War; the cartridge and weapons have been obsolete ever since. No sporting or hunting loads are known, as this was exclusively a machinegun cartridge.

Index No. 56

8x58R

Other Designation: 8-mm Danish Krag.

This cartridge was adopted by Denmark in 1889 for the Model 1889 Krag-Jorgensen bolt-action rifle. As with other cartridges of the period, the bullet was originally a long, round-nosed jacketed bullet with a weight of 15.3 grams and a muzzle velocity of about 620 m/s. In 1908, this bullet was replaced by a boat-tailed, spitzer-type bullet weighing 12.7 grams and having a muzzle velocity of 770 m/s. This cartridge remained standard for ground troops until the 8-mm rifle went out of service. The Danish Navy, which was armed with the single-shot 8-mm Remington rifle, continued, however, to use the lower-pressure Model 1889 ammunition. During the 1930s, tracer and AP bullets were introduced into service. The practical range of the M1908 bullet is about 350 meters; the effective range is 900 to 1000 meters. Although the weapons and cartridge became obsolete as service weapons at the close of World War II, a half-million 8-mm cartridges were made in 1959-1960 for use in Greenland, with cartridge cases manufactured by Norma A/S of Sweden. Cartridges in this caliber have also been made in Norway, in Germany, and, in 1916-1917, under contract in the United States. Sporting and target loads are still manufactured by Norma A/S.

In addition to Krag-Jorgensen Model 1889 rifles and carbines and Remington M 1867/1893 rifles, this cartridge was also used in Madsen light machineguns, Models 1904 thru 1939.

Index No. 57

8x59RB

Other Designations: 8-mm Breda; 8-mm Model 1935.

Introduced in Italy in 1935, this cartridge is unusual in that it was developed for and used only in machineguns. With a bullet weight of 13.4 grams and a muzzle velocity of 755 m/s, the boat-tailed, jacketed spitzer-type ball bullet has an effective range of over 1200 meters.

Incendiary, AP-T, and AP bullets have also been developed. These cartridges were used in the Fiat Model 1935 and Breda Model 1937 and 1938 machineguns, which were used through World War II and remained in service well into the postwar period (until about 1960). Military ammunition in this caliber is still available.

Index No. 58

7.92x61 RB

Other designations: 7.92-mm Norwegian machinegun; 7.92x60.8.

This cartridge, like the 8x59 RB, was developed for and used only in a machinegun—the Norwegian Model 29 Browning heavy machinegun. With a boat-tailed, jacketed spitzer-type bullet weighing 14.2 grams and having a muzzle velocity of approximately 760 m/s, this cartridge has an effective range of over 1200 meters. Although in use from about 1929 through World War II, this cartridge is now obsolete for service use. No weapons other than the Browning machinegun are known to have been chambered for this cartridge, nor is it known to have been made outside of Norway.

DST-1160G-514-81-VOL 1  
11 September 1981

Index No. 58a

11.35x62

Other Designation: 11.35-mm Madsen.

The 11.35x62 cartridge was designed by Dansk Industri Syndikat, a Danish firm, and developed by Kynoch, Ltd., in the United Kingdom, for use in the 11.43-mm Madsen machinegun. Although the gun never achieved widespread popularity, it was adopted by Argentina. Cartridges in this caliber were made in the 1930s by Kynoch, and in 1940 to 1946 by Argentina. Bullet weight is 19.83 grams and muzzle velocity, 850 m/s. Kynoch production included ball, AP, tracer, and a smoke tracer-incendiary type with a white phosphorus filler. Kynoch's color coding for these types is as follows: Ball--no color tip; AP--green bullet tip; tracer--red bullet tip; and smoke tracer (WP filler)--blue tip.

Index No. 59

7.62x63

Other Designations: US caliber .30; caliber .30-06; caliber .30 Springfield.

As introduced in 1903 for the Model 1903 Springfield bolt-action rifle, this cartridge had a case length of 65 mm and used the same long, round-nosed jacketed bullet as its predecessor, the caliber .30 Krag-Jorgensen rifle. The muzzle velocity was 670 to 700 m/s. In 1906, as a result of the demonstrated effectiveness of France's pointed Balle D bullet and Germany's S-type spitzer bullet, a flat-based, jacketed spitzer-type bullet weighing 9.72 grams was adopted, and the cartridge case length was reduced by 2 mm to accommodate the new bullet. This cartridge was designated Model 1906. Its muzzle velocity was 816 m/s. To accommodate the shorter cartridge case, Model 1903 rifles were recalled from service and modified.

During World War I, AP, tracer, incendiary, and even explosive bullets were developed; all were dropped at the end of the war except for tracer and AP types, on which development continued. In 1925, a heavy, boat-tailed spitzer bullet, designated M1, replaced the M1906 as standard. This bullet, designed for long-range machinegun fire, weighed 11.2 grams and had a muzzle velocity of 792 m/s. In 1940, the M1 bullet was dropped in favor of a flat-base 9.73-gram bullet with a muzzle velocity of 835 m/s. During World War II, AP-T and API types were widely used. Although replaced in the US service by the 7.62x51 cartridge in 1957, this cartridge is still in wide use throughout the world. The practical range of this cartridge is 350 meters; effective range (depending on the weapon and cartridge used) is 900 to 1500 meters.

Weapons chambered for the 7.62x63 cartridge include the US Model 1903 series, Model 1917, and M1 rifles; Model 1918 series automatic rifles; Model 1917 series, Model 1919 series, and M37 machineguns; Belgian FN Model 49 rifle and Model D automatic rifle; and Mexican Model 1954 rifle and Model RM-2 Mendoza light machinegun. Cartridges in this caliber are still manufactured in many countries in both military and sporting loads.

Index No. 60

8x63

Other Designation: 8-mm Swedish Machinegun.

This cartridge was adopted in 1932 as a machinegun cartridge; in 1940, a rifle was developed that also used it. The boat-tailed, jacketed spitzer-type ball bullet weighs 14.2 grams and has a muzzle velocity of 750 m/s; tracer, AP, and API versions are also known. Its performance should be identical to that of the 7.62x63 cartridge, which it closely resembles. Since the bullet diameter is 8.2 mm, caution must be exercised not to attempt to fire this cartridge in a weapon chambered for the US cartridge; the resulting overpressure could destroy the weapon and kill or injure the shooter. Identification can be definitely established from case and bullet dimensions and headstamp marking. This cartridge was in use through World War II but is now obsolete. It is not known to have been made elsewhere than in Sweden. Weapons chambered for this cartridge include the Swedish M40 rifle and machineguns M 14/29, M36-series, and M-42.

Index No. 61

13x64B

Other Designations: 13-mm Type 2 Aircraft Machinegun; 13-mm MG-131.

This World War II cartridge was developed in Germany in the 1930s for the Rheinmetall-Borsig MG-131 aircraft machinegun; Japan made this cartridge for use in the Japanese version, the Type 2 aircraft machinegun.

German-made cartridges are readily identifiable by the typical headstamp marking; Japanese headstamp markings are not known, but they may be navy markings similar to the 13.2x99 cartridge. Cartridge cases are usually electric-primed, but early percussion-primed cases are known. Both countries used explosive cartridges: the German high-explosive tracer and high-explosive incendiary tracer can be recognized by the yellow projectile body and the point-detonating fuze, marked AZ 1532. Japanese HE-T projectiles have a red body with brown band; the HE projectiles have a maroon, or rust-colored body. The fuze is a simple air-gap type. The Japanese incendiary projectile, which contains WP, has a yellow body. Appropriate precautions should be taken if it is necessary to handle known or suspected explosive ammunition. Neither the German nor the Japanese guns or ammunition are reported in use since the close of World War II.

Index No. 62

12.7x77

Other Designations: .50 BAT; .50 Spotter-Tracer.

The United States introduced this shortened version of the US 12.7x99 cartridge about 1953 to provide a spotting cartridge with a good trajectory match for the US 106-mm M40-series recoilless rifle, generally known as the BAT. A practice (ball) bullet is identified by an olive-green bullet tip; the M48-series spotter-tracer bullet has a yellow and red color coding, and the bullet tip appears hollow. These cartridges are used only in the US M8-series spotting rifles, which are still in service in several countries. These cartridges cannot be fired in standard 12.7x99 machineguns. Because of the friction- and impact-sensitive nature of the spotting element, a degree of caution should be observed in handling this cartridge. The 12.7x77 cartridge has been made in the United Kingdom, Spain, and Japan, as well as in the United States.

DST-1160G-514-81-VOL 1  
11 September 1981

Index No. 63

12.7x80

Other Designation: 0.5 in Vickers.

Developed by the United Kingdom in 1922, this is the first of the modern .50-caliber cartridges to appear. Although very close in case dimensions to the 12.7x81 SR cartridge, it can be identified by its smaller rim diameter of 18.2 mm. The two cartridges are not interchangeable. The cartridge was adopted as the United Kingdom's standard heavy machinegun cartridge and was used in 0.5-in Vickers machineguns, Mark 1 through Mark 7. Ball, AP, AP-T, and incendiary cartridges are reported. With a bullet weight of 36.6 grams and a muzzle velocity of 750 m/s, performance of this cartridge is distinctly inferior to that of the US 12.7x99 cartridge. Although widely used early in World War II, the guns and ammunition were eventually replaced by US 12.7x99 materiel, and were obsolete at the end of the war. A related cartridge is the more powerful 0.5 in Vickers-Armstrong high-velocity cartridge, developed in 1925, which is identified by its semirimmed cartridge case—120 mm long and nearly 25 mm in rim diameter—and its long tapered shoulder. This cartridge was used in the long-barreled, water-cooled Vickers-Armstrong Class D anti-aircraft guns. It had a bullet weight of about 45 grams and a muzzle velocity of 925 m/s. Despite this impressive performance, and some use by China and the Japanese Navy before World War II, production of this cartridge is reported to have ceased in 1939.

Index No. 64

12.7x81 SR

Other Designations: .5 in Vickers-Armstrong V/565; 12.7 mm Breda; 12.7 mm Japanese HO-103.

This cartridge was developed in 1924 as the 0.5 in Vickers-Armstrong V/565 cartridge, for use in an air-cooled, aircraft machinegun. It can be distinguished from the preceding cartridge by the 19.5-mm diameter of the cartridge rim. This cartridge was adopted in World War II by Italy for use in the Breda-Safat and Scotti I-F aircraft machineguns and by Japan for the HO-103 aircraft machinegun; no UK use during the war is known. Italian and Japanese loadings included HE projectiles in addition to ball, AP, and tracer cartridges. Italian explosive projectiles have a brass nose fuze; the brass-clad steel projectile body may be red, yellow, or blue. An incendiary bullet, containing WP, is identified by a blue bullet tip, while an AP-T bullet has a white tip. All cartridge cases will have an Italian-type headstamp marking, such as SMI/939 or BPD/41. In addition to ball and AP-T types, Japanese loadings included an HEI type with a two-piece, flat-tipped brass fuze, and a fuzeless HEI bullet that is identified by a flat bullet tip and a purple band ahead of the case mouth. The body of the bullet is of brass. Japanese cartridges have no headstamp marking. Safety precautions apply if any of these types must be handled, since they contain PETN, a powerful and sensitive explosive. Bullet weight, velocity, and performance of each cartridge are similar to those given for the preceding 12.7x80 cartridge. The guns and cartridge have been obsolete since the close of World War II.



Index No. 65

7.92x94

Other Designations: 7.92-mm PzB 38; Patrone 318.

Recognizable by its extremely large case diameter (21 mm) in proportion to the small bullet diameter, this cartridge was developed by Germany in 1938 for shoulder-fired, single-shot antitank rifles, the PzB (Panzerabwehrbuechse) 38 and 39. The service cartridge, designated Patrone 318, has a jacked bullet identified by a black tip. The bullet contains a tungsten-carbide core and a tear-gas filler, as well as a tracer. A cartridge with an ordinary ball bullet was used for training. Headstamp markings are normal German style. Bullet weight, muzzle velocity, and performance data are not available. This cartridge saw service in the early part of World War II, but it appears to have been dropped from service due to its lack of effectiveness at any but close ranges. The gun and the cartridge have been obsolete since the early 1940s.

Index No. 66

15x96

Other Designations: 15-mm Mauser; 15-mm MG 151.

Developed in Germany in 1934-1936 for the MG 151 aircraft machinegun, the cartridge was originally percussion-primed; in 1940, an electric-primed version was developed. With a projectile weight of 59 grams and a muzzle velocity of 960 m/s, this was a formidable cartridge; a tungsten-carbide-core, AP bullet is reported to penetrate 38 mm of steel armor at a range of 200 meters. In addition to AP and tracer bullets, three HE projectiles were used; these can be identified by the brass nose fuze, Model AZ 1551. Projectile bodies may be yellow or unpainted. Safety precautions should be observed in handling these ammunition types.

Some MG 151 guns were used by Italy and Japan, but no manufacture of ammunition is reported. Guns and ammunition have been obsolete since the close of World War II.

Index No. 67

12.7x99

Other Designations: Caliber .50 Browning Machinegun (BMG); 0.5 in Browning.

★The United States initiated development of this cartridge after World War I for antiarmor and antiaircraft use: it was soon adopted for aircraft machineguns as well. Essentially a scale-up 7.62x63 cartridge, its bullet weight of 46 grams and muzzle velocity of 865 m/s, combined with its accuracy and reliability, make it very effective against lightly protected targets. AP, tracer, and incendiary bullets are available; no explosive bullets are made in this caliber. The 12.7x99 cartridge is produced by many Western countries and in Japan, Saudi Arabia, Israel, and Egypt as well. The United Kingdom also makes spotting cartridges in this caliber for the L21A1 spotting machinegun. All cartridges, regardless of where manufactured, will function in the Browning 12.7-mm (caliber .50) M2 and M3 series of machineguns. Guns and cartridges are widely used and are expected to remain in service well into the future. New weapons chambered for this cartridge include the US GECAL 50 Gatling aircraft machinegun and new US semiautomatic and bolt action sniper rifles developed by Barrett Firearms Manufacturing Co., Napco International, Inc., and Small Arms Development and Testing Company.

Index No. 68

13.2x99

Other Designations: 13.2-mm Breda; 13.2-mm Vickers Armstrong;  
13.2-mm Hotchkiss; 13.2-mm Japanese Type 93;  
13.2-mm Japanese Type 3.

This cartridge was made in the United Kingdom by Kynoch, Ltd., as early as 1926 for use in a Hotchkiss machinegun. During World War II, the 13.2x99 cartridge was used in several machineguns: the UK Vickers-Armstrong, the French Hotchkiss, the Italian Breda, and the Japanese Type 93 and Type 3 guns. With a bullet weight of approximately 51 grams and a muzzle velocity of 800 m/s, the 13.2x99's performance approached that of the US 12.7x99 (caliber .50) cartridge. Although most bullets were of conventional types, Japan made a HEI bullet that contained PETN as well as an incendiary. This cartridge can be identified by a flat bullet tip and a yellow primer annulus. The headstamp will be a typical Japanese Navy headstamp, with Western date but with place of manufacture indicated by a Japanese syllabic character. Caution should be exercised if the cartridge must be handled. French and Belgian cartridges may be as short as 96 mm in length, and German cases, with an even shorter case neck, may measure as short as 93.5 mm. The guns and ammunition are not reported in use since the close of World War II.

Index No. 69

13.9x99B

Other Designation: 0.55 in Boys Antitank Rifle.

This cartridge was developed by the United Kingdom in 1935 for the Boys Antitank Rifle. The 60-gram steel-core projectile had a muzzle velocity of 758 m/s and a reported penetration of 21 mm of steel at 274-meters range. This performance proved inadequate during World War II, and the gun and cartridge were obsolete by the end of the war. This cartridge was used in the Mark 1, Mark 1\*, and Mark 2 Boys rifles.

Index No. 70

15x105

Other Designations: 15-mm Czechoslovak ZB60; 15-mm M1938;  
15-mm BESA.

This cartridge was developed by Czechoslovakia and used in the ZB60 (M1938) heavy machinegun and in a single-shot Czechoslovak antitank rifle. The cartridge was also used in the pre-World War II British-made 15-mm BESA Mk1 machinegun, a copy of the Czechoslovak design. With a bullet weight of 74 grams and a muzzle velocity of 960 m/s, the AP bullet could penetrate 20 mm of steel armor at a range of 250 meters. Czechoslovakia also made an HE-T cartridge, which can be identified by a flat-tipped



about 825 m/s; these figures will vary depending on bullet type. Because of the heavier bullet, performance is marginally better than that of the 12.7x99 cartridge. Types of the 12.7x108 cartridge include API; API-T; HE-T Type MDZ and an HEI Type ZP. This last type is identified by its flat-tipped, hollow-point projectile, which has an internal air-gap fuze. Though not known to be in current use, this cartridge should be handled with caution if found, since it contains an explosive charge of PETN. The Type MDZ is identified by its all-red bullet with a visible seam 7 mm below the bullet tip. This bullet contains an HE charge of RDX and aluminum powder and, if found, should be handled with great care. The 12.7x108 cartridge is made in many Communist countries and in at least one other country--Egypt--as well. Both brass and lacquered-steel cartridge cases are in use. This cartridge is used in the Soviet DShK M38/46 machinegun, NSV machinegun and Model A12.7P aircraft machinegun, the Czechoslovak quad-mount M53 antiaircraft machinegun, and the Chinese Type 54, Type 77, and Type W-85 heavy machineguns. A rimmed version of this cartridge, the 12.7x108R, was used in the Soviet ShVAK 12.7 machinegun at the opening of World War II and, briefly, in the M1938 antitank rifle. The rimmed cartridge case had a longer shoulder than the rimless version, and although both types used the same bullets, they were not interchangeable. The ShVAK and its ammunition disappeared from the scene early in World War II, but 12.7x108 machineguns and ammunition remain in use in many countries of Europe, Asia, and Africa.

Index No. 73

14.5x114

Other Designations: 14.5-mm Soviet Machinegun;  
14.5-mm Chinese Type 56.

This cartridge is noteworthy in that it started its service life as an antitank rifle cartridge; the antitank rifles became obsolete but the cartridge's excellent ballistic characteristics led to development of a heavy machinegun to take advantage of the 200-gram bullet weight and 1000-m/s muzzle velocity. Cartridge types include API; API-T; I-T; and HE-T Type MDZ. The latter type, which contains a HE charge of RDX and aluminum powder, can be identified by the all-red bullet with a joint or junction visible 7 mm from the bullet tip. (Caution: This cartridge is hazardous, and safety precautions must be observed.)

The 14.5x114 cartridge was used in the PTRS and PTRD antitank rifles during World War II and, to a limited extent, in Korea; these guns are now obsolete in the USSR. The cartridge is used in the ZPU-1, ZPU-2, and ZPU-4 antiaircraft machinegun systems, which use the KPV machinegun, and in the Chinese Type 56 heavy machinegun. As is true of the 12.7x108 cartridge, 14.5x114 cartridges are made in many Communist countries and in Egypt as well. Both brass and lacquered-steel cartridge cases can be found. Use of the guns and cartridges is widespread both within and outside of the countries of manufacture.

★ Index No. 74

15x115

Other Designation: 15-mm BRG Machinegun.

This weapon and its ammunition were developed in the 1980s by Fabrique Nationale of Liege, Belgium to fill a free world gap between 12.7- and 20-mm weapons. The purpose was to develop a weapon and ammunition system retaining many features (such as cost and weight of the 12.7-mm M2 HB) and approaching 20 mm in terms of performance and effectiveness. At the same time, Fabrique Nationale was determined to produce a free world alternative to the Soviet 14.5-mm KPV machinegun that would be superior in performance. The BRG-15 heavy machinegun, along with its ammunition, is expected to enter mass production by the end of the 1980s. Ammunition types currently include APDS, API, APEI, TP, and AP.

11 September 1981

## SECTION IV

## MARKING PRACTICES BY COUNTRY

## A. GENERAL

1. Scope

This section summarizes cartridge headstamp marking and functional type identification practices as well as packaging practices for selected ammunition-producing countries. A glossary of small-arms terms and abbreviations is added to facilitate the interpretation of container markings and labels on packaged ammunition.

2. Organization

Countries are arranged in alphabetical order, with the addition of World War II--Germany as a separate element, following the USSR in sequence.

## B. COUNTRY MARKING PRACTICES

3. Argentina

a. Headstamp Marking Practice. Argentine military headstamps are identified by factory designators at the 12 o'clock position. Aside from the ORBEA mark used in 1943, the designators shown below have been used during the years indicated. These are found with numerous variations but almost invariably include a two-digit or four-digit year code and, occasionally, a caliber designation.

F.A.M.A.P.	Fabrica Argentina de Municiones de Armas Portatiles (1936-1937)
F.A.M.M.A.P.	Fabrica Argentina Militar de Municiones de Armas Portatiles (1937-1944)
FLB	Fray Luis Beltran (post-1958)
FMCSF	Fabrica Militar de Cartuchos San Francisco (1954)
F.M. "FLB"	Fabrica Militar "Fray Luis Beltran" (1961-1975)
F.M.C. "SL"	Fabrica Militar de Cartuchos "San Lorenzo" (1950-1955)
F.M.M.A.P.	Fabrica Militar de Municiones de Armas Portatiles (1939-1944)
F.M.M.A.P. "B"	Fabrica Militar De Municiones de Armas Portatiles--Borghi (1944-1950)





11 September 1981

## Current Argentine Color Coding System

<u>Bullet tip</u>	<u>Primer annulus</u>	<u>Calibers used</u>	<u>Functional type and designation</u>
None	None	Varied (commercial)	Ball
None	Violet	7.76x17SR through 12.7x99	Ball (C), (S), or (SS)
Maroon	Maroon	7.62x51, 7.65x53.5	Ball, for competition (EC)
Black	Black	7.62x51, 7.62x63, 7.65x53.5, 12.7x99	AP (P)
Silver	Silver	7.62x51, 7.62x63	API (PI)
Blue	Blue	7.65x53.5	Incendiary (QI)
Red	Red	9x19, 11.43x23 7.62x51 7.65x53.5 12.7x99	Tracer (T)
Black/ red	Black	7.65x53.5	AP-T (PT)
Yellow	Yellow	7.62x51, 7.65x53.5	Observation (R)

c. Packaging. The standard Argentine packaging practice is not known. A color stripe corresponding to the bullet tip code is placed on the top of the wooden packing box to indicate type of contents.

d. Glossary. See glossary under Spain.

#### 4. Australia

a. Headstamp Marking Practice. For military cartridges Australia follows the UK headstamp pattern, which combines a factory designator with a code indicating the bullet type. Factory designators have in the past included MF, MG, MH, MJ, MQ,

and MW; the only designator in current use is MF. In recent years sporting cartridges in caliber 6.2x45 (.243 W) have been produced with IMI (Imperial Metal Industries, Ltd.) and MYRA factory designators.

b. Cartridge Type Identification and Packaging. Australia follows UK practice in indicating functional cartridge type and in packaging.

## 5. Belgium

a. Headstamp Marking Practice. Fabrique Nationale, located in Herstal, Belgium, produces military cartridges for foreign sales as well as domestic use. Although other types of headstamps have been reported used on special orders, the letters FN normally are found either with a two-digit year date or in combination with other letters or symbols. Some care is necessary to distinguish FN-produced cartridges from other cartridges whose headstamps contain these letters, such as Mexico, Portugal, and Spain.

b. Cartridge Type Identification. Cartridges produced on contract for foreign countries may include the type designation in the headstamp marking (app I, A-140, A-155, A-156). Cartridges made for domestic use will follow the NATO type coding that is described under "US."

c. Packaging. Cartridges produced on foreign contract are packaged as prescribed by the purchaser. Although domestic packing may vary, one type consists of a sealed sheet-metal case that contains 48 cardboard cartons of 20 cartridges each. The cartons and the case have a bilingual label, in French and in Flemish, identifying the contents.

d. Glossary. See glossary under France.

## 6. Bulgaria

a. Headstamp Marking Practice. Earlier headstamp practice (app I, headstamps B-2, B-4) has been completely replaced in post-war years by the factory code 10, nearly always at the 12 o'clock position, and a two-digit year marking at 6 o'clock.

b. Cartridge Type Identification. Bulgarian cartridges follow the Soviet color tip identification pattern.

c. Packaging. Packaging is identical to that of Soviet cartridges: two sealed metal containers in a wooden box. Metal and wooden containers carry a stenciled marking in Cyrillic that identifies the contents. Bulgarian markings can be distinguished by the factory code 10 in two concentric circles, in the upper right and, usually, lower right corners (fig 20). Packaging of

special-purpose cartridges (tracer, API) is indicated by a color stripe or stripes on each container, corresponding to bullet tip color, following Soviet practice. Abbreviations and cartridge designations follow Soviet practice.

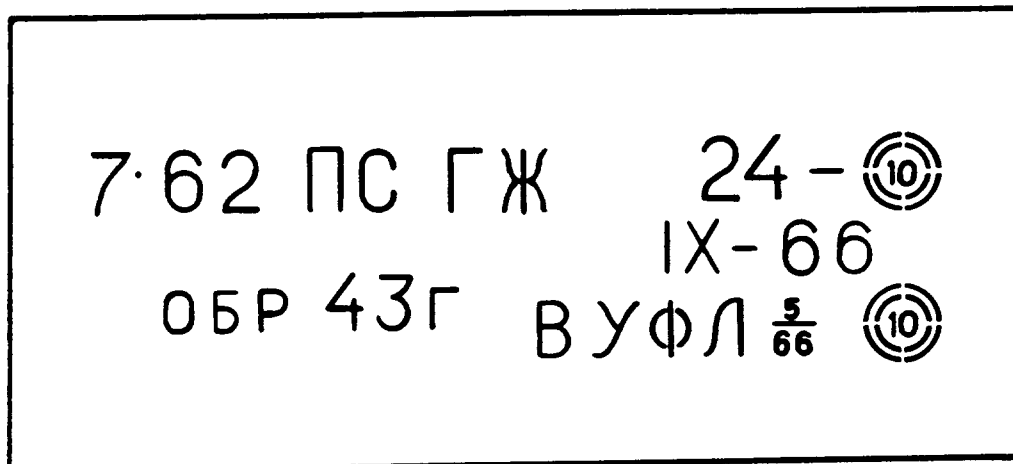

Neg. 531450

Figure 20. Bulgarian Sheet-Metal Container Markings,  
7.62x39 Ball Cartridges, Type PS

#### 7. Canada

a. Headstamp Marking Practice. Canadian military cartridge headstamps are identified by the following factory designators: DA, DAC, DC, D.C.CO, DI, and IVI. These identifiers are combined with two-digit or four-digit year markings, and in past years have often included caliber or bullet type. In recent years Canada has followed NATO headstamp practice.

b. Cartridge Type Identification. During World War II, Canada followed UK practice in indicating bullet type and propellant loading in the headstamp and by primer annulus colors. Cartridges of more recent manufacture have specifically Canadian model designations, with bullet type indicated by the NATO bullet tip color code.

c. Packaging. Packaging will vary, depending on year, caliber, and type of cartridge; identification from stenciled data will pose no problem.

#### 8. China

a. Headstamp Marking Practice. The early years of the present government's production, from 1949 to 1952, produced a variety of headstamps on cartridges made for captured Japanese and Nationalist Chinese arms. No clear pattern of marking can be distinguished; symbols or factory codes and year dates, however, are always present. Starting in 1952 with factory code 11, China

has adopted standard ECC marking practice, using a two-digit year date and a two-digit (or, more recently, three-digit and four-digit) factory code. The factory code normally appears in the 12 o'clock position but has at times been noted at 6 o'clock on 14.5x114 cartridges. Factory codes in use since 1952-1953 include 31, 41, 61, 71, 81, 321, and 661. It should be noted that factory code 11 is also used by Yugoslavia; Chinese headstamps differ in having no serifs at the top of the numerals. An exception to this rule is a 14.5x114 cartridge, dated 1967, with serif-type numerals.

b. Cartridge Type Identification. China adopted Soviet bullet tip color coding with the introduction of Soviet-type weapons and ammunition in the 1950s. Because China makes fewer functional types in each caliber, there is no need for a full range of bullet tip color codes; for this reason China, starting in 1967, simplified the color coding of cartridges. As an example, China makes only one ball cartridge in caliber 7.62x54R; designated the Type 53, this cartridge is a copy of the Soviet LPS bullet in this caliber. The Soviet bullet has a white tip for identification, and until 1967 the Chinese version was similarly marked; but since this is the only ball cartridge in that caliber, the color marking was dropped as unnecessary in all subsequent production. The former and present color codes appear in table II.

c. Packaging. Chinese packaging and marking conform to ECC practice, with two sealed metal containers in a wooden box. Metal and wooden containers carry a stenciled marking of ECC pattern, with Western numerals used for caliber, year type, lot and factory number, and year dates. Simplified Chinese characters indicate the functional type and case material. Color code markings follow ECC practice but conform to the Chinese bullet color code; thus, containers of cartridges made before 1967 may carry color codes that differ from those of current manufacture. Figure 21 shows a metal container marking of current type. Chinese stenciled markings indicating bullet type and case marking appear in the glossary.

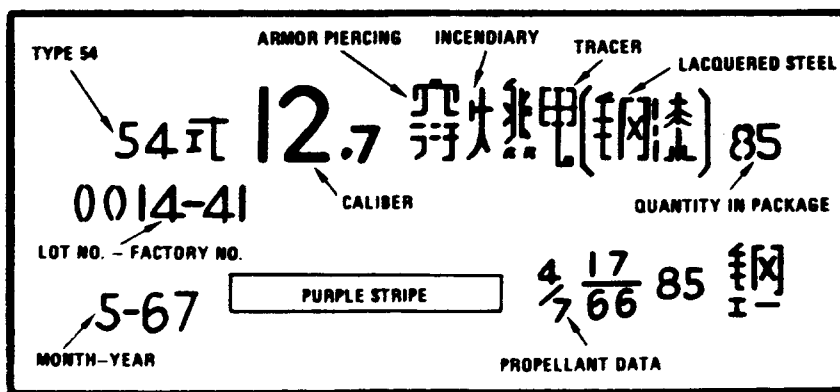

Neg. 524665

Figure 21. Chinese Sheet-Metal Container Markings,  
12.7x108 API-T, Type 54 Cartridges

Table II. Chinese Small-Arms Ammunition Color Coding Practice

Cartridge type and designation	Bullet color code	Packaging color code	Remarks
<b>7.62x39 for assault rifles and light machineguns</b>			
Tracer, Type 56	Green bullet tip	Green stripe	Current marking
API, Type 56	Black bullet tip, red ring	Black stripe above red stripe	Pre-1967 marking
API, Type 56	Black bullet tip, black primer annulus	Black stripe	Current marking
I-T, Type 56	Red bullet tip	Red stripe	May be obsolete
<b>7.62x54R for heavy machineguns</b>			
Ball (mild steel core), Type 53	White or silver bullet tip	White stripe, or rectangular black frame	Marking discontinued by 1967
API, Type 53	Black bullet tip, red ring	Black stripe above red stripe	Pre-1967 marking
API, Type 53	Black bullet tip	Black stripe	Current marking
<b>12.7x108 for machineguns</b>			
API, Type 54	Black bullet tip, red ring	Black stripe above red stripe	Pre-1967 marking
API, Type 54	Black bullet tip	Black stripe	Current marking
API-T, Type 54	Violet bullet tip, red ring	Violet stripe above red stripe	Pre-1967 marking
API-T, Type 54	Violet bullet tip	Violet stripe	Current marking
<b>14.5x114 for machineguns</b>			
API, Type 56	Black bullet tip, red ring	Black stripe above red stripe	Pre-1967 marking
API, Type 56	Black bullet tip	Black stripe	Current marking
I-T, Type 56	Red Bullet Tip	Red stripe	Current marking

d. Glossary.

(1) The Chinese numerals, which are also used in Japan and elsewhere in the Far East, appear below:

Chinese	Western	Chinese	Western
一	1	六	6
二	2	七	7
三	3	八	8
四	4	九	9
五	5	十	0

(2) Markings found on packing labels and containers are presented in table III.

Table III. Markings on Chinese Small-Arms Ammunition Labels and Containers

Printed form	Stenciled form	Meaning
穿	穿	AP
銅 銅	銅 銅 銅 銅	Brass (copper)
夾	夾	Clip (in clips)
總重	毛重	Gross Weight
燃	燃 燃 燃	Incendiary
鉄	鉄 鉄 鉄	Iron (cartridge case)

Table III. Markings on Chinese Small-Arms Ammunition Labels and Containers (Continued)

Printed form	Stenciled form	Meaning
公斤	公斤	Kilograms
漆	漆	Lacquer (on cartridge case)
輕	輕 輕	Light (weight)
批	批	Lot
普 普	普 普 普 普	Ordinary (ball cartridge)
手	手 手	Pistol
發 发	发	Rounds (number in package)
鋼 鋼	鋼 鋼 鋼 鋼	Steel
曳	曳 曳 曳	Tracer
式	式 式	Type

9. Czechoslovakia

a. Headstamp Marking Practice. Prewar military cartridge headstamps are divided into quadrants by segment lines and contain a factory code (M, SB, or Z) with a year date or caliber designation. This pattern was followed to a limited degree until 1942 under German occupation (app I, headstamp A-371), although Czechoslovak wartime production is more generally indicated by a German code designator, such as ak or dou (see World War II--German). In the immediate postwar years the prewar pattern was reintroduced, but without segment lines and using factory codes PS and Z. From 1949 to 1952, a new series of symbol codes was used (app I, headstamps C-31 to C-36) that may contain a curved bar indicating the presence of one flash hole rather than two in the Berdan primer pocket. This feature, a holdover from German wartime production, was intended to provide better ignition. Commencing in 1952, military cartridges have been identified by letter codes aym (to mid-1960s), czo (1956), bxn (1952 to present), and, since 1957, ZV. Commercial cartridges that bear the letters SB in the headstamp and are packed in cartons that carry the Sellier & Bellot trademark are produced at the state-owned Blanické Strojírny plant at Vlašim, the successor to the prewar Sellier & Bellot firm.

b. Cartridge Type Identification. Czechoslovak 7.92x57 cartridges made in the early postwar period, before 1952, are identified as to type by primer annulus color: Green, black, or blue indicates ball cartridges; a red primer annulus indicates tracer and a white primer annulus AP cartridges. In 1952, Czechoslovakia introduced the short-lived series of 7.62x45 M1952 cartridges; these, and the successor Soviet-caliber cartridges, follow the Soviet bullet tip color code. Two 7.62x39 M1943 cartridges of Czechoslovak design have been added: a ranging cartridge for training, designated Zm43, and a short-range practice cartridge, designated Rd 43. Both types have round-nosed jacketed bullets; the Zm43, which contains a tracer, has a green bullet tip with a white band to the rear, while the Rd 43 bullet has a white tip.

c. Packaging. Packaging follows the Soviet pattern; two sealed sheet-metal containers in a wooden box. Metal and wooden containers carry a stenciled marking that identifies the contents. Czechoslovak packaging can be identified by the use of Czechoslovak abbreviations, and the three-letter factory designators (fig 22). The abbreviation "Ks" (quantity in container) on the wooden box indicates Czechoslovak origin. Packaging of special-purpose cartridges (tracer, API) is indicated by a color stripe or stripes on each container, following Soviet practice.

d. Glossary. See table IV.



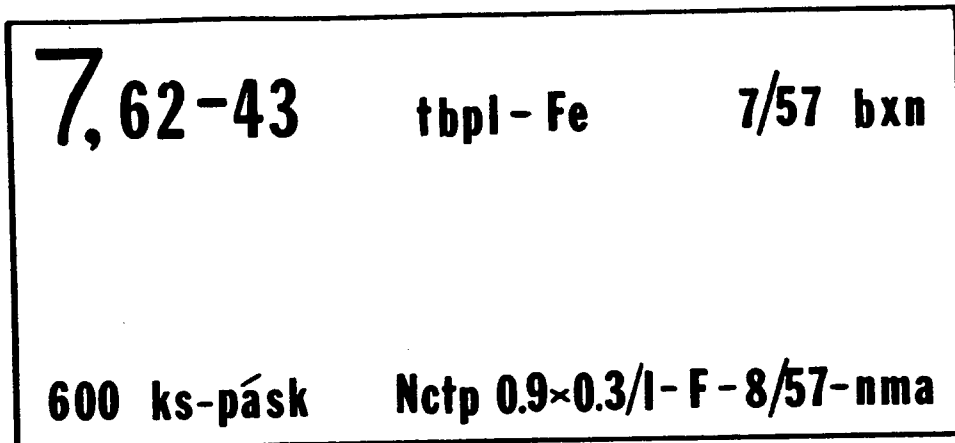

Neg. 525237

Figure 22. Czechoslovak Sheet-Metal Container Markings, 7.62x39 Ball Cartridges in Clips

Table IV. Abbreviations and Terms on Czechoslovak Small-Arms Ammunition Packaging

Abbreviation	Czechoslovak	English
Cv	cvičný	Blank
Cv-okraj	cvičný okrajový	Blank rimmed
Fe	(ocel)	Steel
Kr	karabina	Carbine
Ks	kus	Piece, unit, each
Náb	náboj	Cartridge
Ostr	ostrý	(indicates ball cartridge)
Pi	pistolový	Pistol
Pásk	páskovaných	(in) Chargers or clips
PZ	prubojný zápalný	API
Rd	redukovaný	Practice
Sk	skolní	Dummy
S	svíticí	Tracer
Sv	svíticí	Tracer
Tbpl	tombakovýplech	Gilding metal clad
Tz	těžkou	Heavy (pointed ball)
Tz Sv	těžkou svíticí	Heavy tracer
Vz	vzor	Model
Z	zápalný	Incendiary
Zá	zástřelný	Ranging (combat cartridge)
Zm	zaměřovací	Ranging (training cartridge)

10. Denmark

a. Headstamp Marking Practice. From 1900 to 1937, Danish military cartridges were identified by the letters HL (Haerens Laboratorium, for Army Laboratory) at the 6 o'clock position in the cartridge headstamp, with the year date split between the 9 o'clock and 3 o'clock positions. At 12 o'clock was placed either a crown or a combination of letters and numerals identifying the cartridge case metal supplier and the year of metal production. Exceptionally, the letters HA may be found in the 12 o'clock position. From 1951 to 1955, the letters AA or AMA (standing for Ammunition Arsenal) were placed at 6 o'clock, with a two-digit year marking at 9 o'clock and 3 o'clock, and a crown at 12 o'clock. Starting in 1955, a new headstamp style was introduced, having the letters AMA at 12 o'clock and a two-digit year date at 6 o'clock. Cartridge cases that have been reloaded for Home Guard use are identified by an added surcharge, normally a small triangle. During World War II, 9x19 cartridges produced under German occupation carry a two-digit year date at 12 o'clock and the letters PJJ at 6 o'clock.

b. Packaging. Packaging will vary, depending on the year, caliber, and type of cartridge. External containers carry markings that indicate the caliber, type, and quantity of contents. Current production of military cartridges follows NATO standards as to calibers, color coding, and packaging.

11. East Germany

a. Headstamp Marking Practice. Since 1950 East Germany has manufactured military cartridges in several calibers that are identified by the factory codes 04 and 05 together with a two-digit year date (app I, headstamps D-6, D-7, and D-8). Commercial cartridges are reported with the headstamp SB, two rosettes, and the caliber designation (app I, headstamp A-372).

b. Packaging. The 7.62x39 military cartridges are packed 20 per cardboard carton. The carton flap bears a printed label in German indicating type and quantity of contents. Sixty-eight cartons or 1320 cartridges are packed in a single sheet-steel container in a wood outer container. Both containers are marked with type and quantity of contents and lot number information.

c. Glossary. See glossary under World War II--Germany.

12. Egypt

a. Headstamp Marking Practice. Through 1958, the Arabic name for Egypt, "Misr" (app I, headstamp B-25), appeared at 12 o'clock together with a two-digit year date. From 1959-1971, a three-letter Arabic acronym for United Arab Republic occupied the 12 o'clock position (app I, headstamp B-28). Since 1971, the

three letters have been rearranged; they now represent the Arab Republic of Egypt (app I, headstamp B-31). Each headstamp exists in at least two patterns but always includes a two-digit year date. Egypt uses the Western (astronomical) year system.

b. Cartridge Type Identification. Color coding for Soviet-type cartridges follows the Soviet bullet tip coding pattern; US-type 12.7x19 (caliber .50) cartridges follow the US color coding pattern.

c. Packaging.

(1) Soviet-type 7.62-mm cartridges are packed in thin cardboard cartons of 50 cartridges, sealed with a paper label (fig 23). This label provides data on the type and quantity of cartridges, the producer, and year and lot data. A diagonal color band further identifies the contents as to caliber and functional type. The 9x19 pistol cartridges are packed in cartons of 36 cartridges. Color identification markings for 7.62-mm and 9-mm cartridges are given in table V. The 12.7-mm and 14.5-mm cartridges follow the Soviet pattern in having no interior pack; they are bulk-packed in sealed sheet-metal containers in the wood box.

Table V. Color Coding of Interior Packaging,  
 Egyptian Small-Arms Ammunition

Caliber	Cartridge type	Color code
7.62x39	Ball	Diagonal blue stripe
7.62x39	Tracer	Diagonal blue stripe with green tips
7.62x39	API	Diagonal blue stripe with black and red triangles at tips
7.62x54R	Ball	Diagonal tan stripe
7.62x54R	Tracer	Diagonal tan stripe with green tips
9x19	Ball	Two parallel horizontal tan stripes, one above and one below label data

These factors have been rearranged; they now represent the Arab Republic of Egypt (app I, heading 1). There are at least two patterns but the data. Egypt uses the Western (app I, heading 1) type cartridges follows the Soviet type 12.7x19 (caliber .50) cartridge patterns.

3. Packaging.

(1) Soviet-type 7.62-mm cardboard cartons of 50 cartridges (fig 23). This label provides the color band further identifies the functional type. The 9x19 caliber cartons of 50 cartridges. Caliber 7.62-mm and 9-mm cartridges are and 14.5-mm cartridges follow the interior pack; they are held together in the wood box.

Table V. Color Coding of Egyptian Small-Arm

Caliber	Cartridge Type	Color
7.62x39	Ball	Blue
7.62x39	Tracer	Green
7.62x39	API	Black
7.62x39	Ball	Blue
7.62x39	Tracer	Green
9x19	Ball	Blue



Neg. 524458  
 Figure 23. Egyptian Label From  
 Carton of 50 7.62x39 API Cartridges

(2) Exterior packaging consists of a hinged wooden box having a sealed tinplate liner. Box contents are as follows:

7.62x39 cartridges	2000 per box
7.62x54R cartridges	1200 per box
9x19 cartridges	1450 per box
12.7x108 cartridges	200 per box
14.5x114 cartridges	168 per box

Boxes carry stenciled markings in Arabic that identify the contents as to caliber, functional type, quantity, and year and lot data. Boxes containing ball cartridges are not color-coded; boxes holding other types of cartridges (API, tracer) have color codes that correspond to the bullet-tip color code. The box codes, which differ from those used in ECC practice, appear in table VI. Arabic caliber designations in typical stenciled form appear as follows.

7.62x39	٣٩ x ٧,٦٢ or ٣٩ x ٧,٦٢
7.62x54R	٥٤ x ٧,٦٢ or ٥٤ x ٧,٦٢
9x19	٩
12.7x108	١٢,٧
14.5x114	١٤,٥

Arabic terms indicating cartridge type (ball, tracer, API) are presented in the glossary, table VII.

Table VI. Color Coding of Exterior Packaging, Egyptian Small-Arms Ammunition









Caliber	Cartridge Type	Color Code	
		Box Front	Box Ends
7.62x39	Tracer	 Diagonal green stripe	None
		 Two green stripes on box rear	None
7.62x39	API	 Black above, red below, on all corners	
7.62x54R	Tracer	None	 Green stripe on both box ends
12.7x108	API	 Black above, red below, on all corners	
12.7x108	API-T	 Purple above, red below, on all corners	
14.5x114	API, API-T	Like corresponding 12.7x108 types	

Table VII. Arabic Terms on Small-Arms Ammunition Packaging

Arabic	English Equivalent
١	1
٢	2
٣	3
٤	4
٥	5
٦	6
٧	7
٨	8
٩	9
٠	0
نار ق	AP
عادية	Ball (ordinary) (type bullet)
كارتة	Cartridges
مصر	Egypt
جرام	Grams (abbreviation)
في كرتون	In cartons
نار ح	Incendiary
كجم	Kilograms (abbreviation)
مم	Millimeters (abbreviation)
نار ليل	Night tracer
نار	Tracer

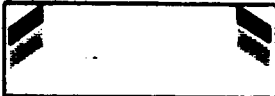
13. Finland

a. Headstamp Marking Practice. Cartridges of Finnish manufacture will have one of the following types of headstamps: LAPUA plus caliber; SAKO plus caliber (and, rarely, a two-digit year date); SO plus a two-digit year date; or VPT plus a two-digit year date and, rarely, the caliber. Examples of these headstamps appear in appendix I. Aside from military cartridges, sporting ammunition in a wide variety of calibers is exported.

b. Packaging. Packaging for export will vary to meet customers' specifications. A typical packing of 7.62x39 cartridges is 50 cartridges per printed cardboard carton; 20 cartons (1000 cartridges) in a wooden box. Cartons and box will bear an identifying marking that may be in Swedish and English as well as Finnish.

c. Glossary. See table VIII.

Table VIII. Abbreviations and Terms on Finnish Small-Arms Ammunition Packaging

Abbreviation	Finnish	English
Kpl	hylsy	Cartridge case
	ilman	Without
	kappale	Each, piece
	kivääri	Rifle
	konekivääri	Semiautomatic rifle
	konepistooli	Submachinegun
	laatiko	Box
	latausharjoitus	Loading training
	lentojuokot	For aircraft use
	luoditon	Bulletless
	luoti, luodin	Bullet
	matalapaine	Low-pressure
	messing	Brass
	nalli	Primer
ps	nitroselluloosa	Nitrocellulose
	panos	Charge, weight
p. patr	panssari	AP
	patruuna	Cartridge
pist	paukku	Dummy
	pikakivääri	Light machinegun
	pistooli	Pistol
	ruostuttamaton	Noncorrosive
syt	ruutipano	Propellant charge or weight
	sieiteita	
	sytytin	Incendiary
vj	tarkkuus	Adjustment
	vain pistoolille	For pistols only
	valojuova	Tracer



11 September 1981

14. France

a. Headstamp Marking Practice. French military headstamps present at first view a confusing array of headstamp patterns and an overwhelming variety of letter codes. If they are first classified by headstamp pattern and then by their letter and numeral codes, the identification problem is simplified. Until the 1930s, a headstamp divided into quadrants by segment lines (app I, headstamp A-25) was in wide but not exclusive use for older types of standard French service cartridges. This four-element design is also found with variations in arrangement of design elements (headstamp A-384). From 1912 to perhaps 1968, a four-element design without segment lines was also used, with the quarter (trimester) and year of manufacture reading vertically, on the pattern of headstamp A-381; headstamp A-384 shows a variant of this pattern. A third major style of headstamp in use from 1950 to recent years, continues the four-element design but places the date of manufacture at 12 o'clock and the cartridge caliber at 6 o'clock. Again, variants of this pattern are found; for 12.7x108 cartridges, for instance, the caliber and date locations are reversed. Since 1956, 7.62x51 NATO cartridges have had a three-element headstamp with the NATO mark at 12 o'clock and the cartridge manufacture and year occupying the 4 o'clock and 8 o'clock positions. Headstamp A-410 represents this type. Other headstamp patterns, including two-element headstamps, are known, but their use has been quite limited; they have the manufacture's code at 12 o'clock and the year at 6 o'clock (headstamp A-28).

b. Manufacturers' Codes. Military cartridge headstamps always include a two-letter or three-letter code that identifies the cartridge producer; usually but not invariably the headstamp includes a one- or two-letter code that indicates the supplier of the cartridge case metal. In a four-element design the producer's code is normally at 9 o'clock, and the metal supplier's at 3 o'clock; this arrangement was reversed for 1949-1957 production of 12.7x99 cartridges with producer code MR (MANURHIN). Codes that have been in general use since 1930 include the following:

<u>Cartridge manufacturer</u>		<u>Metal supplier</u>		
AP	RS	A	ES	N
ATS	SF	AN	F	P
CN	TE	B	FY	PC
CP	TH	BA	GP	R
LM	TS	BD	H	S
MI	VE	BDV	HMB	SD
MR	VS	BS	HX	SF
PX		C	I	TA
		CCM	L	V
		CY	M	
		D		

French commercial cartridge production is identified by the following marks, which may appear singly or in combination: CF intertwined; Gevelot; Gaupillat; G's intertwined; G plus star; and SFM (see headstamps A-57 and A-385).

c. Cartridge Type Identification

(1) Three systems for visual identification of functional cartridge types have been used. The prewar system initially involved only bullet jacket color; as new types were introduced and the available range of bullet jacket colors became inadequate, bullet tip colors and case mouth and primer annulus colors were added. Some of these color codes were continued into postwar years. The postwar system involves bullet tip colors alone; with a few modifications in 1958, it is still in use. The third identification system, involving primer annulus colors only, was limited to prewar production of 13.2x99 cartridges. It should be noted that cartridges manufactured during World War II in the occupied area of France carry German-type headstamp and functional code markings.

(2) The prewar system, which was different for each caliber, is shown below in table IX. Cartridge calibers such as 7.65x20 that involve ball cartridges only and have no special identifying features are not included.

Table IX. Prewar Color Coding Practice,  
 French Small-Arms Ammunition

7.5x54					
Bullet jacket color	Bullet tip color	Case mouth color	Primer annulus color	Functional type	Remarks
Cupronickel	None	None	None	Light ball	
Blackened	None	Violet	Violet	Heavy ball	
Brass	None	None	None	AP	
Brass	Green	Green	Green	AP-T	In postwar use
Brass	Black	Black	Black	Tracer	In postwar use
Cupronickel	Blue	Blue	Blue	Incendiary	In postwar use

11 September 1981

Table IX. Prewar Color Coding Practice,  
French Small-Arms Ammunition (Continued)

8x50.5R (Lebel)	
Bullet jacket	Functional type
Brass (bronze) Cupronickel Tinned Blackened	Ball (solid bronze) Ball (lead core, CNJ) Tracer AP

13.2x99	
Primer annulus color	Functional type
Black Green Red Yellow	Ball Tracer AP AP-T

(3) The postwar system utilizes bullet tip color codes that are applicable to the calibers listed below. It will be noted that until 1958 the French air forces used a variant color coding system; since that year all services have used a single system. Cartridges without a bullet tip color are, regardless of caliber, ball cartridges.

Table X. Postwar Color Coding Practice,  
French Small-Arms Ammunition

Bullet tip color	Calibers	Functional type	Remarks
Violet	7.5x54 only	Heavy ball	Not used after 1958
Gray	12.7x99	Ball	Not used after 1958
White	8x50.5R (Lebel), 9x19, 12.7x99	Tracer	Not used after 1958
Red	12.7x99	Incendiary	Not used after 1958

Table X. Postwar Color Coding Practice,  
 French Small-Arms Ammunition (Continued)

Bullet tip color	Calibers	Functional type	Remarks
Red	7.5x54, 7.62x33, 7.62x51, 9x19, 12.7x99	Tracer	1958 regulation
Orange	7.62x33, 7.62x63, 12.7x99	Tracer	US color code
Orange	7.5x54	Short range practice (plastic bullet)	Model 1961
Maroon	12.7x99	Tracer	US color code
Black	7.5x54, 7.62x51, 7.62x63, 12.7x99	AP	1958 regulation
Blue	7.5x54, 7.62x51, 7.62x63, 12.7x99	Incendiary	1958 regulation
Dark blue/ light blue	12.7x99 only	Incendiary	US color code
Silver	7.5x54, 7.62x51, 7.62x63, 12.7x99	API	1958 regulation
Yellow	7.62x51	Observation	1958 regulation
Black/white	12.7x99	AP-T	Not used after 1958
Black/red	7.5x54, 12.7x99	AP-T	1958 regulation
Blue/silver	12.7x99	API	Aircraft guns only
Red/silver	12.7x99	API-T	US M20 Type
Blue/red	12.7x99	I-T	1958 regulation
Yellow/red	7.5x54	Observation- tracer	1958 regulation
Silver/red	Unknown	API-T	1958 regulation

d. Packaging.

(1) Several types of internal packaging have been used, depending on the caliber and type of weapon and period of manufacture. Cartridges of prewar manufacture may be packaged in paper-wrapped packets; more recent practice utilizes cardboard cartons, bandoliers, or linked belts, packed in one or more sealed metal containers in a wood box. Common to all packaging is the use of a package label that provides information on quantity, caliber, and type of contents; component lot data; and special packing, if any (in clips or links). The wooden container is marked with quantity, caliber, type, model, special packing (links or clips) of contents, and other packaging data.

(2) Internal and exterior packaging of color coded cartridges have color stripes and correspond to the bullet tip color. Carton labels may have diagonal stripes or colored corner markings; current practice provides a vertical color stripe on each side of the label. Figure 24 shows a typical carton label. Wooden boxes (exterior containers) have corresponding vertical stripes at the ends. Containers of ball cartridges have no color marking; white stripes on the box ends indicate blank cartridges. Figure 25 shows an example of the current marking system. Caliber and type of ammunition should be verified from the printed data, as color codes on boxes of pre-1958 manufacture may differ from current practice. Some of the differences that may be found are presented in table XI.

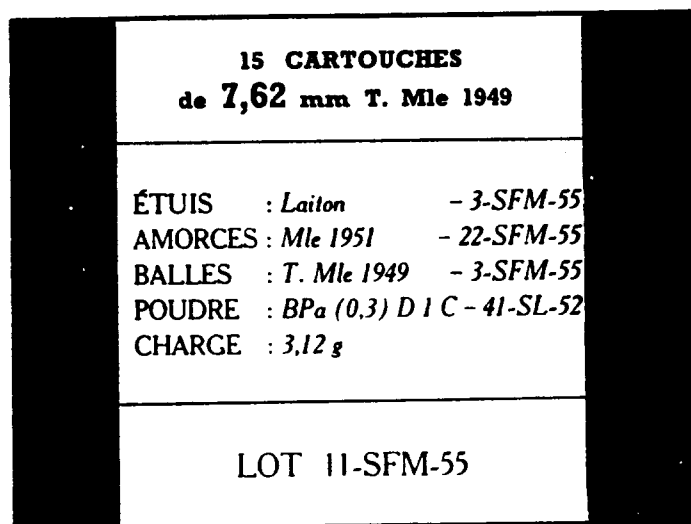

Neg. 525236

Figure 24. Packing Label for French-Made  
7.62x63 Cartridges M1949

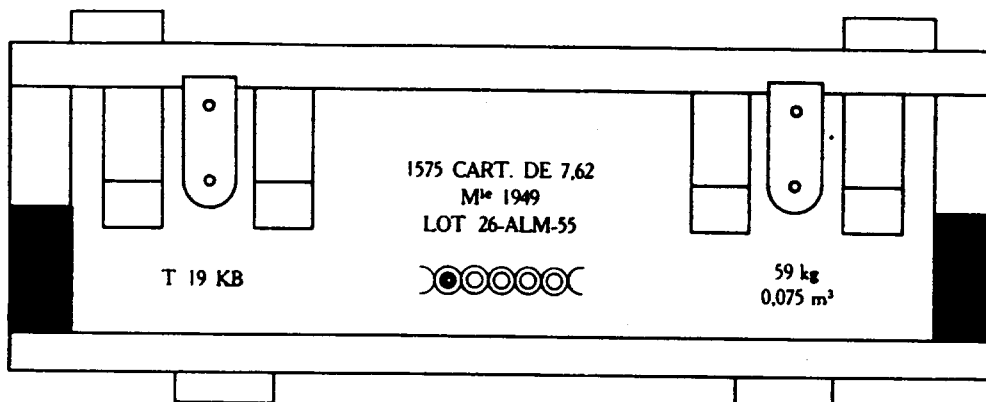

Neg. 525235

Lower half of end stripes is red, upper half uncolored, indicating mixture of ball and tracer cartridges.

Figure 25. Box Marking for French-Made 7.62x63 Cartridges, Linked 4 Ball to 1 Tracer

Table XI. Color Coding of Exterior Packaging, French Small-Arms Ammunition

Current container marking	Functional type	Former container marking
None	Ball	Yellow or violet
Black	AP	Green
Black/red	AP-T	Green/red
Blue	Incendiary	Red
Red	Tracer	White

e. Glossary. See table XII.

Table XII. Abbreviations and Terms on French Small-Arms Ammunition Packaging

Abbreviation	French	English
AA	arme automatique	Machinegun
	à blanc	Blank
	acier	Steel
Am.	amorce	Primer
Bal.	balle	Bullet
	bande	Belt
	bois	Wood
	boîte	Box
	boîte cloisonnée	Divided box
	carton	Cardboard
Cart.	cartouche	Cartridge
Ch.	charge	Propellant weight
	chargeur	Charger
	corps	Body
C	courte	Short
Et.	étui	Cartridge case
F	fusil	Rifle
FL	fusil	Rifle
FM	fusil-mitrailleuse	Light machinegun
FR	fusil à répétition	Bolt-action rifle
FX	fausse	False
I	incendiaire	Incendiary
IT	incendiaire traçante	I-T
	inerte	Inert
L	long, longue	Long
	lame chargeur	Strip charger
	laiton	Brass
	liège	Cork
	lourde	Heavy
M, Mle	modèle	Model
M, MIT	mitrailleur, mitrailleuse	Machinegun
	matière plastique	Plastic material
N	NATO	North Atlantic Treaty Organization
O	ordinaire	Ball (bullet)
OTAN	Organisation du Traité de l'Atlantique du Nord	NATO
P	perforante, perforant	AP
PA	pistolet automatique	Semiautomatic pistol
Pdr., pdre	poudre	Propellant
PI	perforante incendiaire	Perforating incendiary
PIT	perforante incendiaire traçante	API-T
PLAST	matière plastique	Plastic material
PM	pistolet mitrailleur	Submachinegun
	portée réduite	Short-range

Table XII. Abbreviations and Terms on French Small-Arms Ammunition Packaging (Continued)

Abbreviation	French	English
R	réglage	Spotting
RT	réglage traçante	Spotter-tracer
T	traçante, traceur, traceuse	Tracing, tracer
TIRED.	tir réduite	Gallery practice, subcaliber
TP	traçante perforante	AP-T
V.B.	Viven-Bessières	Rifle grenade discharged from a cup-type launcher

15. Germany

a. Headstamp Marking Practice. German (FRG) headstamps are predominantly of the three-element style, though two-element and four-element designs are not uncommon. Headstamp elements include a two-letter or three-letter producer code, typically an abbreviation or an acronym for the manufacturer, which may appear in the 12 o'clock, 6 o'clock, or 8 o'clock position. Other elements may include caliber designation or NATO mark, a two-digit year date, and lot number. Producer (factory) codes that identify German production include DAG, DNG, DWM, GECO, IAC, IWK, ME, MEN, MS, RWS, and S.K.D.

b. Cartridge Type Identification. Germany follows NATO bullet tip color coding practice.

c. Packaging. Packaging practice is varied; it may include cardboard cartons, sealed polyethylene inner pack, and metal or wooden boxes. Containers can be identified by the German language marking that, for military ammunition, includes a cartridge model number prefixed by the letters DM, and by one of the producer codes listed in the preceding paragraph.

d. Glossary. See glossary under World War II--Germany.

16. Hungary

a. Headstamp Marking Practice. Prewar 8x56R cartridges are known with segmented headstamps with factory designator at 12 o'clock and year at 6 o'clock (app I, A-14). During World War II the segment lines were omitted and a two-element design used (A-237). Postwar practice has followed the Soviet model, with factory designator 21 or 23 at 12 o'clock and the year at 6 o'clock. (Note: Factory code 21 has also been used by Poland,



11 September 1981

but with design differences that indicate the country of production. See headstamps A-354 and D-25, 26, 27, and 28.)

b. Cartridge Type Identification. Currently Soviet calibers and types of small-arms ammunition carry Soviet nomenclature and cartridge type color identification.

c. Packaging. Hungarian packaging follows the Soviets pattern, with two rectangular sealed sheet-metal containers in a wood box. Internal and external containers carry a stenciled marking indicating contents as to caliber, type, lot, and (on the wood box) quantity. Special-purpose cartridges follow the Soviet pattern in having a color band that corresponds to the bullet tip color. Hungarian markings can be recognized by the transliteration from Cyrillic into Hungarian; by the factory code; and (on the wooden container) by the abbreviation "DB," indicating quantity in box (fig 26).

d. Glossary. See table XIII.

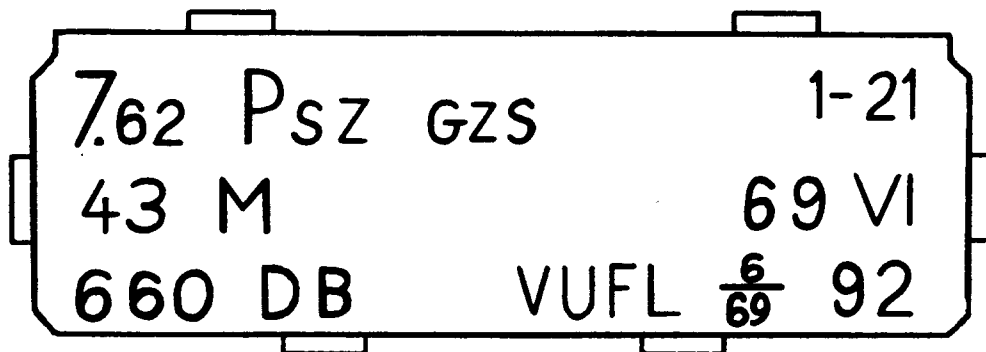

Neg. 525234

Figure 26. Hungarian Wood Container Markings,  
7.62x39 Ball Cartridges, Type PS

Table XIII. Abbreviations and Terms on  
Hungarian Small-Arms Ammunition Packaging

DB .....	
GZS .....	Transliteration of GZh; gilding metal clad steel
PSZ .....	Transliteration of PS: ball cartridge with steel-core bullet
Darab (Db) .....	Each, piece; number in package
Forgópisztoly .....	Revolver
Gyalogságitöltény ...	Ball cartridge
Karabély .....	Carbine
Kézigránát .....	Handgrenade
Lőszer .....	Ammunition (general)
Lőszerlada .....	Small-arms ammunition box

Table XIII. Abbreviations and Terms on Hungarian  
Small-Arms Ammunition Packaging (Continued)

Nyomjelző lövedék .....	Small-arms tracer bullet
Páncéltörő (pct) .....	AP
Pisztoly .....	Pistol
Puska (Pu) .....	Rifle
Puskágranát .....	Rifle grenade
Súly .....	Weight
Töltény .....	Cartridge
Ürméret .....	Caliber
Vaktöltény .....	Blank cartridge

17. India

a. Headstamp Marking Practice. Before and during World War II, and up to 1965, cartridges made at the principal small-arms cartridge plant at Kirkee were identified by the letters K F on either side of a letter I topped by a broad arrow. After 1965, the I and broad arrow were not used. A second factory at Khamaria has used the identifier OK since 1943. The year of manufacture and caliber or type of cartridge are also indicated, following UK practice (app I, headstamps A-226, A-227). From 1959 onward 7.62x51-caliber cartridges, identified as 7.62-mm A and 7.62-mm M80, have replaced 7.7x56R cartridges. From 1965 in a third factory, at Varangaon, has used the identifier OFV (app I, headstamps A-226, K-227, A-292, A-294).

b. Cartridge Type Identification. Until 1965, cartridge (bullet) identification followed the UK pattern; current practice continues use of caliber designation in the headstamp but adds the Indian model designation. Color marking will follow the US pattern.

c. Packaging. Markings on the packaging are in English and are self-explanatory.

18. Iran

a. Headstamp Marking Practice. From the 1930s to 1968, Iranian cartridge headstamps were usually but not invariably divided into quadrants by segment lines. Marking includes Arabic numerals, year dates, and letters; invariably, from the end of World War II through 1968, the headstamp included a crown. Recent (1970-1978) production does not use segment lines (app I, headstamps B-46 to B-49).

b. Cartridge Identification Practice. Cartridges of US calibers follow the US color code marking.

29 May 1987

c. Packaging. One representative type of packaging involves cardboard cartons of 20 cartridges each; 50 cartons or 1000 cartridges are sealed in a thin sheet-metal liner in a wooden box. The outside of the box is stenciled in Arabic with type of contents, quantity, and year and lot data.

## 19. Israel

★ a. Headstamp Marking Practice. During the last 30 years, Israel has used several styles of headstamp marking. For the most part these have in common the use of Hebrew letters (app I, headstamps B-50, B-55). Israel has also made cartridges for export sale with the factory mark TA (Tel Aviv), IMI (Israeli Military Industries) and TZ (Taasiya Tsviat). (See headstamps A-196, A-197, A-404, and A-452.)

### b. Cartridge Type Identification.

(1) For 7.92x57 cartridges, which are no longer in use, color coding involved a combination of bullet tip and primer annulus colors, as follows:

<u>Bullet tip</u> <u>color</u>	<u>Primer annulus</u> <u>color</u>	<u>Functional</u> <u>type</u>
None	Purple	Ball
Red	Green	Tracer
Black	Green	AP
Black	Red	API
Blue	Green	Incendiary

★ (2) Other calibers use only a bullet tip color code. Not all functional types are made in each caliber. The color code is as follows:

<u>Bullet tip</u> <u>color</u>	<u>Functional</u> <u>type</u>
None	Ball
Violet	Blank
Red	Tracer
Black	AP
Blue and black	API
Blue, red, and black	API-T

(Note: The last two codes are found on 12.7x99 cartridges only.)

(3) For 9x19 ball cartridges, a silver tip identifies cartridges intended for use in pistols and revolvers; ball cartridges with no tip color have a more powerful propellant load for use in submachineguns. A blue tip is found on subsonic cartridges.

c. Packaging. Packaging will vary but can be recognized by the combination of Hebrew letters and Western numbers for caliber and quantity.

20. Italy

a. Headstamp Marking Practice.

(1) Military cartridges may have either raised or impressed headstamps; almost invariably they will include a one-, two-, or three-letter manufacturer's identifier with a two-, three-, or four-digit year date. Other markings may be added; until 1943, Bologna (B) and Capua (C) headstamps included the initials of the chief inspector (app I, headstamps A-6, A-7, A-48). Caliber or model designation, or the NATO mark, may also be found (headstamps A-174, A-233, and A-309). The letters S, L, or P indicate, respectively, explosive, tracer, or AP projectiles; MA (prewar) or AM (post-1958) indicates aviation use. Factory codes used on military headstamps include the following:

<u>Factory code</u>	<u>Producer</u>
B	Pirotecnico di Bologna (to 1942 only)
BPD	Bombrini-Parodi-Delfino
C	Pirotecnico Esercito di Capua
GFL	Giulio Fiocchi, Lecco
LBC	Leon Beaux and Company
PEC	Pirotecnico Esercito di Capua
P.C.	Pirotecnico Esercito di Capua
SMI	Societa Metallurgica Italiana

Three military headstamps are known that do not include a factory identifier (headstamps A-244, A-245, and A-246).

(2) Sporting cartridges may carry such manufacturer's names as BEAUX, L. BEAUX, FIOCCHI, or LB-M (Leon Beaux Milano).

b. Cartridge Type Identification.

(1) Prewar and wartime cartridge identification practice utilized bullet tip color coding, frequently in combination with other features. This practice, which was not uniform for all calibers, is summarized in table XIV.

Table XIV. Prewar Color Coding Practice, Italian Small-Arms Ammunition

Bullet tip color	Other identification	Calibers	Functional type
None	None	All	Ball
None	Green primer seal	7.7x56R only	AP
None	Unknown color band at case mouth	13.2x99 only	AP
None	"P" in headstamp	8x59RB	AP, M35
White	—	8x59RB only	AP, M39
White	"Stepped" bullet ogive; may have "S" in headstamp	12.7x81SR only	API-T
Red	—	13.2x99 only	AP-T
Red	May have "L" in headstamp	7.7x56R, 12.7x81SR	Tracer
Red	Red primer seal; may have "P" in headstamp	8x59RB, M41; 12.7x81SR	AP-T
Blue	4 holes in bullet ogive	7.7x56R only	API (WP)
Blue	holes in bullet ogive; red case mouth and primer seal	12.7x81SR only	API (WP)
Blue	2-piece bullet jacket	7.7x56R; 8x59RB; 12.7x81SR	Observation (WP)
Black	—	7.7x56R, 8x59RB	Observation
Green	4 holes in bullet ogive	7.7x56R	API
Green	—	12.7x81SR	AP
(Brass fuze)	Red body	12.7x81SR only	HE
(Brass fuze)	Light blue body	12.7x81SR only	HE-T
(Brass fuze)	Dark blue body	12.7x81SR only	I-T
(Long brass fuze)	Yellow body	12.7x81SR only	HEI-T

(2) Postwar cartridge identification practice has conformed to US and NATO cartridge tip color coding.

c. Packaging. Cartridges are normally packaged in cardboard cartons, with a printed label in Italian identifying the contents as to caliber, functional type, quantity, manufacturer, and lot number. Special packing (i.e., clips or link belts) or weapon type data may also be included (fig 27). Cartons are packed in a sealed metal case liner in a wooden box carrying identification data similar to those on the carton.

d. Glossary. See table XV.

Table XV. Abbreviations and Terms on Italian Small-Arms Ammunition Packaging

Abbreviation	Italian	English
Cal.	arme	Rifle, weapon
	balistite	Double-base propellant
	bossolo	Cartridge case
	calibro	Caliber
	carabina	Carbine
	caricatori	Chargers (clips)
	caricato	Charged (clipped)
Cart.	cartuccia	Cartridge
	capsula	Primer
	frangibile	Frangible
Fuc.	fucile	Rifle
Inc., Incend.	incendiaria	Incendiary
	lotto	Lot
M, MOD.	modello	Model
Mitr.	mitraglia,	Machinegun
	mitragliatrice	
	moschetto	Carbine
	nitrocellulosa	Single-base propellant
Ord.	ordinaria	Ball bullet
	ottone	Brass
Pall.	pallotolo,	Bullet
	pallotola	
Perf., Perfor.	perforante	AP
	piastri	Chargers (clips)
	pistola	Pistol
	proiettile	Bullet
	propellente	Propellant
	salve	Blank (cartridge)
	solenite	Double-base propellant
	tiro ridotto	Gallery practice
	tombacco	Gilding metal
	Tracc.	tracciante

11 September 1981



Neg. 525233

Figure 27. Carton Marking on Italian-Made  
7.62x51 Ball Cartridges

## 21. Japan

### a. Headstamp Marking Practice.

(1) Up to the close of World War II, service cartridges for army use carried no headstamp. Blank or dummy cartridges may carry a mark that resembles a dot in parentheses (app I, headstamp C-29). Cartridges for naval use (7.7x56R, 13.2x99) have a three-element headstamp that includes a Japanese-language character indicating the producer as well as the caliber and year of manufacture in Western and Roman numerals (headstamps C-22 to C-24).

(2) Postwar cartridge headstamps have included the manufacturer's code, and for military cartridges the year, in Western letters and numerals. Sporting cartridges carry the cartridge designation instead of the year. Postwar manufacturers' codes include the following: AO; AOA; J-AO; J-AOA; J-ST; J-TE; and TOYO (app I).

### b. Cartridge Type Identification.

(1) Cartridge identification to the close of World War II was by color markings, which varied for army and navy cartridges and were not uniform for all calibers in each service. Marking practices are summarized in table XVI. It should be noted that all incendiary bullets contain WP and that all HE and HEI bullets contain PETN; especially in view of their age, some hazard is involved in their handling.

Table XVI. World War II Color Coding Practice,  
 Japanese Small-Arms Ammunition

Army color coding					
Case mouth color band	6.5x50.5SR	7.7x58	7.7x58SR	7.92x57	12.7x81SR
Pink	Ball	Ball	Ball	Ball	---
Green	Tracer	Tracer	Tracer	---	Tracer
Black	---	AP	AP	AP	AP-T
Magenta	---	---	Incendiary (WP)	Incendiary (WP)	---
Purple	---	---	---	---	HEI (fuzeless)
White	---	---	HE (PETN)	---	HEI (RDX) (brass fuze)
Red	---	---	---	---	Ball
Green/white	---	---	---	---	AP-T

Navy color coding		
Primer or annulus color	7.7x56R (primer color)	13.2x99 (primer annulus)
Black	Ball	Ball
White	AP	AP
Red	Tracer	Tracer
Green	Incendiary (WP)	---
Purple	HE (PETN) (blunt copper bullet)	---
Yellow	---	HEI (PETN)

13x64B only*	
Projectile body color	Functional type
Black	Ball
White	AP-T
Red	Tracer
Yellow	Incendiary (WP)
Red with brown band	HE-T (PETN)
Maroon (rust color)	HE (PETN)

\*All projectiles have a nose fuze or dummy fuze plug.



11 September 1981

(2) The postwar cartridge identification pattern has followed the US and NATO color code system.

c. Packaging. Postwar packaging generally follows US specifications but can be identified by the Japanese manufacturers' codes and lot numbers. Cartons or bandoliers may also carry Japanese-language markings.

d. Glossary. For standard Chinese/Japanese numerals, see glossary under China.

## 22. Lebanon

a. Headstamp Marking Practice. Cartridges produced for Lebanon in 1956 are identified by a stylized evergreen tree (the Cedar of Lebanon) flanked by two Arabic letters that stand for "Republic of Lebanon." The headstamp also includes Arabic numerals for caliber and year of manufacture and the Arabic letters m m d, indicating manufacture by Defense Industries Establishments, Damascus, Syria (app I, headstamp C-46). No domestic manufacture is known.

b. Packaging. Packaging in cartons and wooden boxes follows the French pattern; printed carton labels provide data in Arabic on caliber, type, and quantity of contents and component lot data.

c. Glossary. See glossary under Egypt.

## 23. Netherlands

### a. Headstamp Marking Practice.

(1) In prewar years an unsegmented 4x90 layout predominated, with a 2x180 format used to a lesser degree. Various year, number, and letter combinations were used; one marking pattern provided a 2-digit year date of cartridge case manufacture at 12 o'clock, with the year of cartridge loading at 3 o'clock and a propellant lot number at 9 o'clock. The 6 o'clock position had either a brass lot number or a letter; the letters D, G, O, and P have been noted. Headstamps A-69 and A-70 in appendix I, are representative of these types. The letters AI (Artillerie Inrichtingen) indicate Dutch origin.

(2) Postwar manufacture has utilized two-, three-, and four-element layouts but always with a factory designator; AI or its recent successor, EMZ; or NWM.

b. Cartridge Type Identification. Postwar cartridge identification practice has followed the US and NATO bullet tip color code system.

c. Packaging. Dutch packaging conforms generally to NATO practice; packaging can be recognized by the Dutch terms used.

d. Glossary. See table XVII.

Table XVII. Abbreviations and Terms on  
Dutch Small-Arms Ammunition Packaging

Abbreviation	Dutch	English
br	brand-	Incendiary
kar	karabijn	Rifle; carbine
ls	losse	Blank (cartridge)
lsp	lichtspoor	Tracer
	mitrailleur	Machinegun
ms	messing	Brass
pbr	pantserbrand	API
ptn	patroon	Cartridge
pts	pantser-	AP
rb	rookzwak buskruit	Smokeless propellant
sch	scherpe	Live; ball (cartridge)
	wapen	Weapon; arm
zb	zwart buskruit	Black powder

#### 24. North Korea

a. Headstamp Marking Practice. North Korean headstamps almost invariably consist of two elements, placed at 12 o'clock and 6 o'clock. The factory designator and year code may include one of several symbols--triangle, star, or circle--and a Korean letter or two-digit year code. A recent (1972) headstamp has the factory designator (93) at 12 o'clock, and a two-digit year code at 6 o'clock.

b. Cartridge Type Identification. Cartridges are identified by color tip coding, generally following the ECC pattern.

c. Packaging. Packaging also follows the ECC pattern, with two sealed sheet-metal containers in a wood box. Container markings give the caliber and lot number in Western numerals, with other data in Korean characters (fig 28).

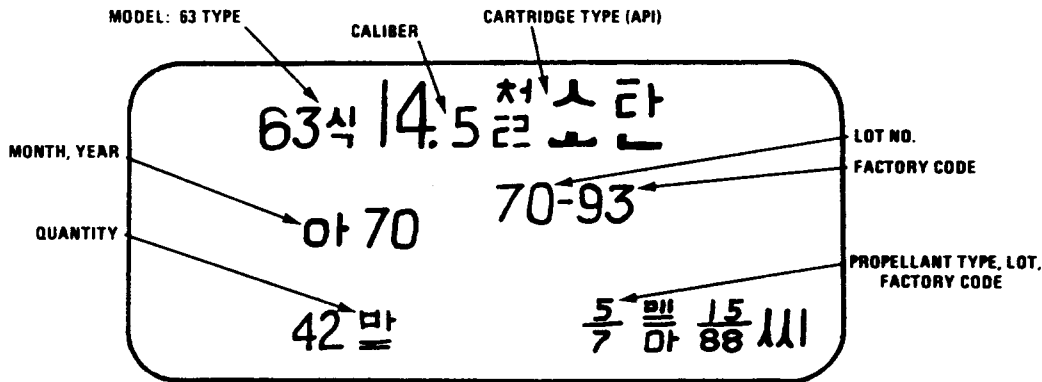

Neg. 524618

Figure 28. North Korean Sheet-Metal Container Markings, 14.5x114 API, Type 63 Cartridges

25. Norway

a. Headstamp Marking Practice. Norwegian cartridge headstamps are predominantly of the two-element pattern, but three- and four-element designs are known; segment lines may be present on cartridges of older (pre-1930) manufacture. Markings may include a crown; factory identifiers AYR or RAUFOSS; or RA in a variety of styles. The RA headstamp can be confused with the US Remington Arms Corporation headstamp but can normally be distinguished through comparison with US headstamps. In case of doubt, definite identification can be established by examining the primer construction; US production uses the Boxer-type primer with a single flash hole, whereas Norway follows the usual European practice of using Berdan primers with two flash holes and an integral primer anvil in the cartridge case. In a single instance, 7.62x51 NATO cartridges have the NATO mark and the letters NP and year date (app I, headstamp A-285).

b. Cartridge Type Identification and Marking Practice. Norwegian production of military cartridges follows NATO standards as to calibers, color coding, and packaging. Cardboard cartons carry labels indicating contents, manufacture, and year and lot number.

c. Glossary. See Table XVIII.

Table XVIII. Ammunition Terms on Norwegian  
 Small-Arms Ammunition Packaging

Norwegian	English
brann	Incendiary (cartridge)
gevaer	Rifle
hastighet	Velocity
hylse	Cartridge case
håndvåpen	Small-arms
krutt	Propellant
kule	Bullet
lette	Light (weight)
løs patron	Blank cartridge
maskingevaer	Automatic rifle; light machinegun
mitraljøs	Machinegun
panserprosjektil	AP bullet
panserprosjektil-brann-	
sporlysprosjektil	API-T bullet
patron	Cartridge
pipe	(gun) barrel
prosjektil	Projectile; bullet
skarpe	Live; ball (cartridge)
sporlys	Tracer (cartridge)
tennhette	Primer
tunge	Heavy (weight)

26. Poland

a. Headstamp Marking Practice.

(1) Prewar headstamps utilized a four-element design layout with segment lines normally but not invariably present. Design elements included an identifying letter code—such as DZ, F, or N—and frequently a Polish eagle. A two-digit year date is found on all but dummy cartridges. The code 67 may be present; this number, following German practice in World War I, indicates the specific brass case metal alloy. Arrangement of the design elements is not fixed; the eagle may be at 12 o'clock or 3 o'clock and the year date at 3 o'clock or 6 o'clock. Production during the German occupation followed German headstamp practice.

(2) Early postwar production of Soviet-type cartridges used three-element or four-element designs without segment lines and with a numerical factory code (21 or 343) in an oval at 12 o'clock. Since 1955, all production has had factory code 21 at 12 o'clock and a two-digit year date at 6 o'clock. In Polish

practice this year date is invariably inverted with respect to the factory code; the base of both sets of numerals is toward the primer. This feature serves to distinguish Polish-made cartridges from those with factory code 21 made by Hungary, which have both sets of numerals reading in the same direction.

b. Cartridge Type Identification. Color coding follows Soviet practice.

c. Packaging. Packaging is identical to Soviet practice, with two sealed metal containers in a wooden box. Metal and wooden containers carry a stenciled marking of Soviet pattern, but in Polish, that identifies the contents. Indicators of Polish origin are the letters "Ł" or "Z" following the caliber designation, or the abbreviation "WZ" (model) and "szt" (quantity in container). Figure 29 shows a typical Polish container marking.

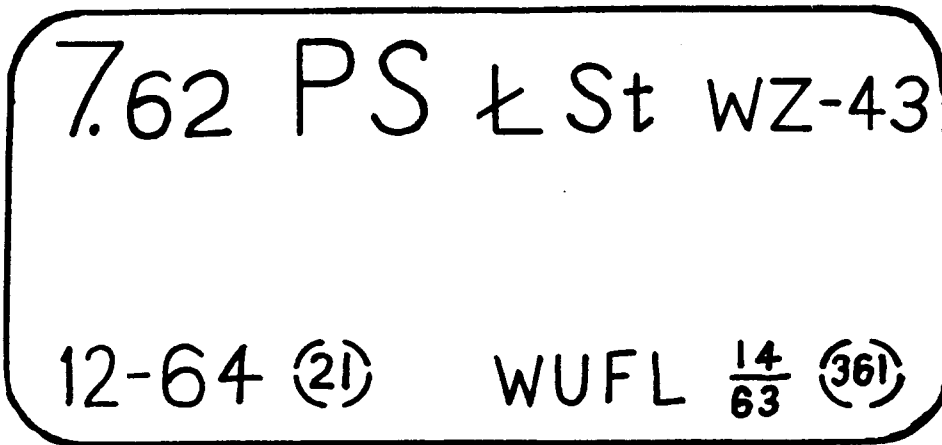

Neg. 525232

Figure 29. Polish Sheet-Metal Container  
Marking, 7.62x39 Ball Cartridges

d. Glossary. See table XIX.

Table XIX. Abbreviations and Terms on Polish Small-Arms Ammunition Packaging

Abbreviation	Polish	English	
C	ciężki	Heavy (bullet); corresponds to Soviet Type "D"	
	ciężar	Weight	
	ćwiczebne	Training	
	czarny	Black	
	czerwony	Red	
	część (głowicowa)	Tip (of bullet)	
	długość	Length	
	fiolety	Violet	
	lekki	Light (weight)	
	lodka (lodkach)	Clips	
	liczba	Number	
	łuska	Cartridge case	
	Zm	łuska mosiężna	Brass cartridge case; corresponds to Soviet GL
		ZSt	łuska stalowa
ZZ	łuska żelazna		Gilding metal clad steel cartridge case; corresponds to Soviet GZh
	miesiąc	Month	
	mosiężny	Brass	
	naboj	Cartridge	
	naboj ślepy	Blank cartridge	
	nazw	Nomenclature	
	pancerno-	Armor-	
	pociskow	Bullet	
	prędkość	Velocity	
	prochu	Propellant	
	rok	Year	
	smugowy	Tracer	
	stalowa	Steel	
	Wz	szuk	Each: units (in package)
wzor		Model	
zapalajacy		Incendiary	
zielony		Green	
żółty		Yellow	
zwykłym		Ordinary; ball (cartridge)	

27. Portugal

a. Headstamp Marking Practice. Prewar production of military cartridge was identified by a four-element design with segment lines. The intertwined letters AE (Arsenal do Exercito) appear at 12 o'clock and the year date at 6 o'clock. Postwar production uses a two-, three-, or four-element headstamp that includes the letters FNM (Fabrica Nacional de Municoes) and the year date (app I, headstamps A-144, A-145, and A-148).

b. Cartridge Type Identification. Current production follows US/NATO color tip marking.

28. Taiwan

a. Headstamp Marking Practice. Production on the mainland until 1949 was identified by three-element or unsegmented four-element headstamps that include a factory symbol, caliber designation, and a two-digit year date. ROC year dates are computed from 1912, the year of the revolution; thus, 12 years must be added to the indicated date to give the Western calendar date. Since removal to Taiwan, military production has been identified by factory code 60A plus the ROC year date; the caliber designation is normally but not invariably present. ROC 7.92x57 cartridges with Chinese characters and year dates of 42 to 44 are of US wartime (1942-1944) production for the ROC (app I, headstamps C-1, C-2, C-4 to C-7, and C-9).

b. Cartridge Type Identification and Packaging Practice. Taiwan's production of small-arms cartridges follows US specifications as to caliber, type, color coding, and packaging.

c. Glossary. Chinese-style numerals and their Western counterparts are presented under China.

29. Republic of South Africa

a. Headstamp Marking Practice.

(1) Military cartridge headstamp patterns are normally of the two-element type, with manufacturer and year at 12 o'clock and cartridge type or caliber, following UK practice, at 6 o'clock. From 1938 to 1960, production at the South African Mint was identified by the letter U and a two-digit or four-digit year date; the branch mint at Kimberly added a diamond following the letter U. Following independence in 1961, the letter U was replaced by SAM (South African Mint).

(2) Commercial and sporting cartridges do not carry the year date; both PMP and PMP with caliber designation are known.

b. Cartridge Type Identification. South Africa followed UK practice in identifying UK calibers and types by identifying bullet type and propellant loading in the headstamp and by use of primer annulus colors. Production of 7.62x51 NATO-type cartridges is believed to follow US/NATO color tip coding.

30. Romania

a. Headstamp Marking Practice. Production before and during World War II is identified by a four-element headstamp having the letters CMC at 12 o'clock, caliber designation at 6 o'clock, and the year date split between 9 o'clock and 3 o'clock. Segment lines may be present. In postwar years Romania has used two headstamp patterns. One, known from 1957 to 1965, has the factory designator 21 RPR or 22 RPR with a two-digit year date; the other, in use from 1951 to the present, has factory designator 22 at 12 o'clock and the year date at 6 o'clock.

b. Packaging. Packaging follows the ECC pattern, with two sealed sheet-metal containers in a wooden box. Metal and wooden containers carry a stenciled marking of Soviet style, but with Cyrillic letters transliterated into Western (Roman) letters. Identification can be established by the presence of Romanian factory codes, as previously noted. Figure 30 shows a typical Romanian marking on a sheet-metal container of 14.5x114 API cartridges, Type B-32. The color stripes are black above red.

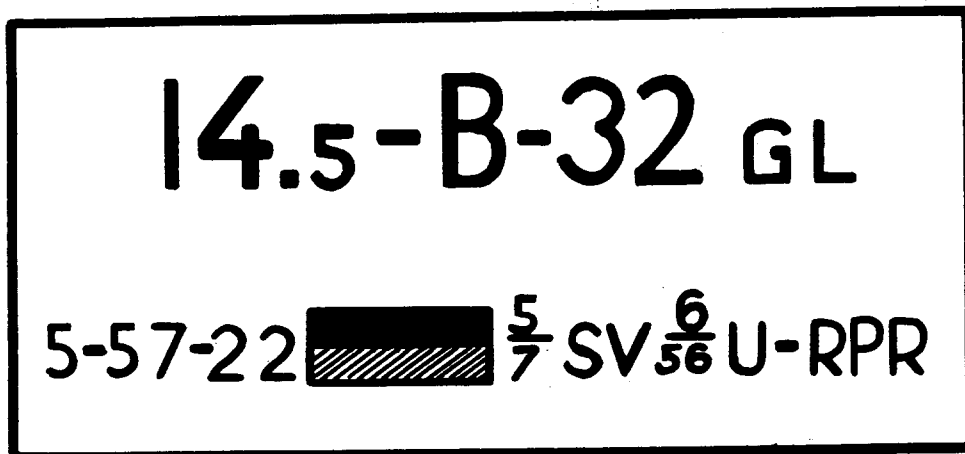

Neg. 525231

Figure 30. Romanian Sheet-Metal Container Markings, 14.5x114 API Cartridges

c. Glossary. See table XX.



**Table XX. Ammunition Terms on Romanian Small-Arms Ammunition Packaging**

Romanian	English
bucăți	Pieces: each; quantity in package
carabină	Rifle
cartușe	Cartridge
glont	Bullet
incendiator	Incendiary
mitraliere	Machinegun
proiectil	Projectile, bullet
praf de pușcă	Black powder
pușcă	Gun

31. Saudi Arabia

a. Headstamp Marking Practice. Cartridges of Saudi Arabian production can be identified by the unsegmented four-element headstamp with a palm tree at 12 o'clock; crossed sabers a 6 o'clock; and arabic numerals at 9 o'clock and 3 o'clock, indicating caliber and year respectively. Saudi Arabia follows the lunar calendar and calculates years from the Hegira; thus, the Islamic year 1390 represents the Western year 1970. Appendix I, headstamp C-47 shows a typical Saudi Arabian headstamp.

b. Cartridge Type Identification. AP 12.7x99 (caliber .50) cartridges have been noted with a purple bullet tip, case mouth seal, and primer annulus, as well as with a black seal, case mouth seal, and primer annulus. The significance, if any, of the color difference is not known. AP-T cartridges in this caliber have green bullet tips and incendiary bullets have orange bullet tips.

c. Packaging. Cartridges are packed in cardboard cartons that bear a printed label that may carry French as well as Arabic language markings, indicating quantity, caliber, and component lot numbers. A diagonal color stripe (not necessarily of the bullet tip color) further identifies the contents as to type. Figure 31 shows a Saudi Arabian carton of 12.7x99 AP cartridges. The diagonal stripe is black.

d. Glossary. See Arabic glossary in Table VII.

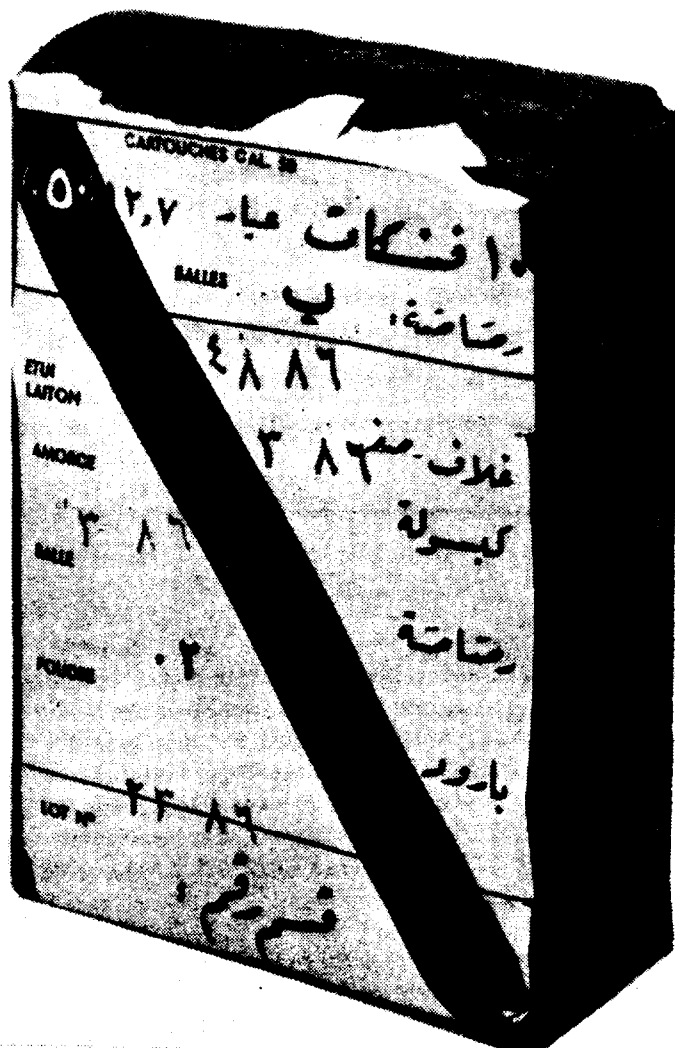

Neg. 525229  
Figure 31. Carton Marking on Saudi Arabian  
12.7x99 AP Cartridges

### 32. South Korea

South Korean military cartridges can carry any of three headstamp markings: the producer code KA and a two-digit year date; PS and a two-digit year date; or a combination of Korean characters and Western numerals that includes a two-digit year date. See appendix I, headstamps A225, A324, A324-1, and C13-1. Color markings and model designations follow US practice.

33. Spain

a. Headstamp Marking Practice.

(1) Spain's several manufacturing facilities have used a variety of layouts and factory identifiers; although some of the latter are easily confused with those of other countries, identification can normally be established from the cartridge designation, layout pattern, and year of manufacture. The predominant layout is a three-element pattern including a factory identifier, caliber designation, and year date. Two-element and four-element headstamps have been used, primarily for sporting cartridges. The factory identifier may be split into two or even three elements, or two identifiers may be included and the year omitted. The principal identifiers are tabulated below:

CIM	Consorcio de Industrias Militares
FNP	Fábrica Nacional de Palencia
FNT	Fábrica Nacional de Toledo
MMM	Manufacturas Metalicas Madrilenas
P	Fábrica Nacional de Palencia
PS	Pirotecniá Militar de Sevilla
S	Pirotecniá Militar de Sevilla
SB	Empresa Nacional Santa Barbara, at Palencia
T	Fábrica Nacional de Toledo

(2) During the Spanish Civil War (1936-1939), at least four cartridge producers made small-arms ammunition for the Loyalist forces. Headstamps were of the style shown in appendix I as A365. The letters S at 9 o'clock and A at 3 o'clock stand for Subsecretaria de Armamento, the agency of the Valencia government that was responsible for ammunition production. A caliber designator appears at 12 o'clock, and the factory code number (1, 3, 9, or 27) at 6 o'clock. Caliber designators are known as follows:

7	7x57
7.6	7.62x54R
7.9	7.92x57
9L	9 Largo (9x23)

b. Packaging. Cartridges are packaged in cardboard cartons; the number per carton will vary with the cartridge

caliber. Each carton bears a label indicating in Spanish the caliber, quantity, producer, and production date. Cardboard containers are packed in a sealed sheet-metal container, painted black, in a wooden packing box. The box bears black stenciled markings in Spanish that correspond to the carton markings. Special-purpose ammunition may be identified by an added marking in Spanish in color, e.g., in orange for tracer cartridges.

c. Glossary. See table XXI.

Table XXI. Abbreviations and Terms on Spanish  
 Small-Arms Ammunition Packaging

Abbreviation	Spanish	English
	bala	Bullet
	capsula	Primer
	cartucho	Cartridge
	cartucho de guerra	Live (ball) cartridge
	cartucho de instruccion	Inert (dummy) cartridge
	corto	Short
	ejercicio	Practice
	especial	Special
ES	especial sobrecargada	High-pressure test cartridge
F	fogueo	Blank (Argentina)
I	incendiaria	Incendiary
None	largo	Long
LP	luminosa perforante	AP-T
N	normal	Ball bullet or cartridge
P	perforante	AP
	polvora	Propellant
QI	quimica incendiaria	Chemical incendiary
R	reglaje	Observation; fire adjustment
S	(German designation see table XXIX)	Light pointed ball
SS	(German designation see table XXIX)	Heavy pointed ball
	salvas	Blank (Spain)
TH	trazante humosa	Smoke tracer (Argentina)
TL	trazante luminosa	Luminous tracer
	vaina	Cartridge case

34. Sweden

a. Headstamp Marking Practice. Military cartridge headstamps have a segmented or unsegmented headstamp that normally

contains three elements; occasionally four elements; and, less often, two elements. Marking elements normally include a two-digit year date and a numeric or alphabetic producer code, and may include a crown. Sporting cartridges carry a manufacturer's mark and caliber designation without a year date. Headstamps on 12.7x99 cartridges have a distinctly different style; examples are given in appendix I, headstamps A-220 and A-286. Military producer codes include numerical codes 24 through 32 and 70; alphabetical codes are tabulated below:

Amf	Norma Projektilfabrik, Åmotfors
K	Karlskrona Naval Arsenal
M	Marieberg Arsenal, Kungsholmen
METALLVERKEN	Svenska Metallverken AB, Västerås
NORMA	Norma Projektilfabrik, Åmotfors
NP	(Same as above)

b. Cartridge Type Identification. Ball cartridges have no bullet tip color code. Other types are identified as follows:

<u>Bullet tip color</u>	<u>Functional type</u>
Red	Tracer (1941 and earlier)
White	Tracer (current)
Black	AP
Orange	Incendiary (8x63 only)
Orange	Tracer (12.7x99 only)
Yellow	API (12.7x99 only)

c. Packaging. Cartridges are packed in cardboard cartons in quantities that are determined by caliber and method of pack--i.e., in clips or belts. Cartons carry a paper label printed in Swedish, indicating quantity, caliber, and functional type. Special packing is indicated by an appropriate figure symbol, which may be color-coded to indicate functional type. Cartons may be sealed in a polyethylene inner liner in a sheet-metal ammunition box or sealed in sheet-metal containers in a wooden box. External containers carry markings indicating contents.

d. Glossary. See table XXII.

Table XXII. Abbreviations and Terms on Swedish Small-Arms Ammunition Packaging

Abbreviation	Swedish	English
ag	automatgevär	Semiautomatic rifle
	äldre	Older
am	ammunition	Ammunition
ask	askar	Boxes
brandprj	brandprojektil	Incendiary bullet
	bandade	Belted
diglkrut	diglykolkkrut	Diglycol propellant
	endast för fredsskjutning	For peace-time use only
g	gevär	Bolt action rifle
gexkr	gevärexerciskrut	Propellant for rifle drill cartridges
gkr	gevärkrut	Propellant for rifle cartridges
k	karbin	Carbine
kal	kaliber	Caliber
kg	kulsprutegevär	Light machinegun
kpist	kulsprutepistol	Submachinegun
kptr	kammarpatron	Low-powered cartridge for indoor firing
ksp	kulspruta	Machinegun
kspband	kulspruteband	Machinegun belt
kspexkrut	kulspruteexerciskrut	Propellant for machinegun drill cartridges
kspkr	kulsprutekrut	Propellant for machinegun cartridges
ml, M	modell	Model
	maskingevär	Heavy machinegun
nband	normalband	Belted ball cartridges
nc	nitrocellulosa	Nitrocellulose
nckrut	nitrocellulosakrut	Single-base propellant
ncglkrut	nitroglycerinkrut	Double-base propellant
NK	Nobelkrut	Nobel double-base propellant
	ny	New
oml	omladdad	Reloaded
övnprj	övnprojektil	Gallery practice bullet
p	pansar	AP
pist	pistol	Pistol
pkr	pistolkrut	Propellant for pistol cartridges
pprj	pansarprojektil	AP bullet
pptr	pansarpatron	AP cartridge

Table XXII. Abbreviations and Terms on Swedish Small-Arms  
Ammunition Packaging (Continued)

Abbreviation	Swedish	English
prj	projektil	Bullet
ptr	patron	Cartridge
ptrask	patronaskar	Cardboard box
ptrh	patronhylsa	Cartridge case
ptrlåda	patronlåda	Wooden case
	ramad	In chargers
red lng	reducerad laddning	Reduced loading
sk	skarp, skarpa	Live (cartridge)
sl, slj	spårlyus	Tracer
slbrandband	spårlyusbrandband	Belted tracer and incendiary cartridges
slnband	spårlyusnormalband	Belted tracer and ball cartridges
slpband	spårlyuspansarband	Belted tracer and AP cartridges
slprj	spårlyusprojektil	Tracer bullet
slptr	spårlyuspatron	Tracer cartridge
svkr	svartkrut	Black gunpowder
th	tändhatt	Primer
	wolframskärna	Tungsten carbide core

### 35. Switzerland

a. Headstamp Marking Practice. Swiss military cartridges carry a four-element headstamp, with month of manufacture at 12 o'clock and a two-digit year date at 6 o'clock. A letter code for the cartridge producer is at 3 o'clock and for the brass case metal producer at 9 o'clock. Cartridges for competition shooting may have an M+FA at 12 o'clock.

b. Cartridge Type Identification. Ball cartridges carry no color identification. Other 7.5x55.5 cartridges are identified by a colored cartridge case head; AP cartridges have a violet case head and tracer cartridges a red case head.

c. Packaging. Rifle and machinegun cartridges are packed in cardboard cartons carrying a printed label in both German and French identifying the contents as to caliber, type, and model. A Swiss cross, in white, is also present. Functional types are indicated by a diagonal stripe on the label, as follows:

<u>Functional type</u>	<u>Diagonal stripe color</u>
Ball	Red
AP	Red-Brown
Tracer	Yellow

Cartons may be packed in a wooden box or in a heavy fiberboard container that carries an identifying label similar to that on the carton except for the indication of quantity.

d. Glossary. See glossaries under France and World War II--Germany.

36. Syria

a. Headstamp Marking Practice. Syria normally uses a four-element design layout, but a three-element design is also known. Current practice places the caliber designation at 12 o'clock; five-pointed stars at 3 o'clock and 9 o'clock; and a two-digit year date in Arabic (not Western) numerals at 6 o'clock. Examples of several marking patterns are presented in appendix I.

b. Cartridge Type Identification. Color tip coding of Soviet-type cartridges follows the ECC and Soviet bullet tip color code.

c. Packaging. Cartridges are packaged in cardboard cartons with white paper labels printed in Arabic. Label data follow the French style in providing detailed component lot data in addition to quantity and type of contents. Cartons are inclosed in a sealed sheet-metal liner, in a hinged wooden box similar in type to ECC packaging. The front of the box carries Arabic markings indicating box contents, lot number, and weight. Figure 32 shows the markings on a box of 1200 7.62x54R ball cartridges.

d. Glossary. See glossary in table VII.





38. United Kingdom

a. Headstamp Marking Practice. Up to 1957, UK military headstamp markings included a producer code and year date, together with a caliber designation and/or a mark number. Two-element, three-element, or four-element layouts were used. The year date was normally expressed by two digits, but the full four-digit year was used from 1933 to 1943 for cartridges for synchronized aircraft machineguns. Starting in 1957, with the introduction of the 7.62x51 NATO cartridge, a new system of cartridge nomenclature was adopted; the model designation, which can be recognized by the prefix letter L (Land), appears in the headstamp. UK producers' codes are presented below:

UK Cartridge Producers' Codes

B	Birmingham Metals and Munitions Co., Ltd.
BD	Hall's Telegraph Co., Burghfield
B+E	Royal Ordnance Factory (R.O.F.), Blackpool
CP	Crompton Parkinson, Ltd.
E	Eley Bros., Ltd.
G	Greenwood & Batley, Ltd.
GB	do
GBF	do
H+N	R.O.F. Hirwaun
J	Birmingham Metals & Munitions Co., Ltd.
K,K2,K4,K5	I.C.I., Ltd. (Kynoch), various plants
KN	Kings Norton Metal Co., Ltd.
M	Nobel's Explosive Co., Ltd.
N	do
RC	Raleigh Cycle Co., Ltd.
RH	do
RG	R.O.F., Radway Green
R+L	R.O.F., Woolwich, London
RW	Rudge Whitworth, Nottingham
SR	R.O.F., Spennymoor
ST	R.O.F., Steaton
SWN	R.O.F., Swynnerton
TH	R.O.F., Thorpe Arch, Yorkshire

b. Cartridge Type Identification.

(1) Up to 1957, cartridge nomenclature followed this pattern:

Cartridge, S.A., 7.92-mm, Incendiary, B MK1Z

The letters S.A. stand for small arms. B is the letter identifier for incendiary cartridges (it should be noted that ball cartridges in all calibers, and 12.7x99 API, have no letter identifiers). MK 1 is the mark (model) number of this incendiary bullet. Until 1945, the mark number was expressed in Roman

11 September 1981

numerals; from that year on conventional Western numerals were used. The suffix Z on the mark number indicates that graphite-glazed, single-base nitrocellulose propellant was used; the absence of the suffix Z means that the propellant is unglazed, double-base cordite. When more than one cartridge exists with the same caliber designation, the nomenclature is expanded to identify the cartridge further, often by reference to the weapon used; for example:

0.30 in, carbine (7.62x33)  
0.30 in, Browning (7.62x63)

(2) Post-1957 cartridge nomenclature makes use of the term "round" for all cartridges that include a bullet; the term "cartridge" is reserved for those such as blank cartridges that do not contain a bullet. The "round" or "cartridge" is further identified by a prefix letter L (indicating land service) and a model number without suffix letter; for example:

Round, S.A., 0.50 in, Browning, Incendiary-Tracer, L1A2  
Cartridge, S.A., 7.62-mm, Rifle Grenade, L1A1

(3) Visual identification of military small-arms ammunition as to functional type primarily involves recognizing the letter identifier, if any, and the model designation in the cartridge headstamp. These may be supplemented by primer annulus color and, for some types, bullet tip color and other features. Practice is not consistent for all calibers. Identification features for small-arms ammunition manufactured to government specifications are presented in table XXIII.

Table XXIII. Small-Arms Ammunition Color Coding  
Practice, United Kingdom

UK service ammunition				
Headstamp identification	Primer annulus color	Bullet tip color	Other feature	Functional type
7.62x33				
1	Purple	None	None	Ball
7.62x51				
L2A1 or L2A2 L5A1 or L5A3 L1A1 or L1A2	Purple Red None	None Red None	None None Rear half of case blackened	Ball Tracer Grenade-launching

Table XXIII. Small-Arms Ammunition Color Coding  
 Practice, United Kingdom (Continued)

UK service ammunition				
Headstamp identification	Primer annulus color	Bullet tip color	Other feature	Functional type
<b>7.62x63</b>				
2Z or 4Z G1Z W1Z or W2Z B1Z or B2Z	Purple Purple Green Blue	None Red None Blue	None None None None	Ball Tracer AP Incendiary
<b>7.7x56R</b>				
7 or 7Z 8Z G1, G2, G3, G7, or G8 G4, G4Z, G6, or G6Z G5 or G5Z W1 or W1Z B4 or B4Z  B6 or B6Z B7 or B7Z 0.1 PG1 or PG1Z  H1Z  H2  H4  H7Z	Purple Purple Red  Red  Red Green Blue  Blue Blue Black Red  None  None  None  None	None None None  White  Gray None None  None Blue Black None  None  None  None  None	None None None  None  None None Step in bullet jacket  None None None Blue band on case base Front half of case blackened Entire case blackened Case blackened 3/4-inch from each end Rear half of case blackened	Light ball Heavy ball Tracer  Tracer  Tracer AP Incendiary  Incendiary Incendiary Observing Practice-tracer Grenade-launching Grenade-launching Grenade-launching Grenade-launching
<b>7.92x57</b>				
1Z or 2Z G1Z, G2Z, or G3Z W1Z or W2Z B1Z or B2Z	Purple Red  Green Blue	None None  None None	None None  None None	Ball Tracer  AP Incendiary

Table XXIII. Small-Arms Ammunition Color Coding Practice, United Kingdom (Continued)

UK service ammunition				
Headstamp identification	Primer annulus color	Bullet tip color	Other feature	Functional type
9x19				
1, 1Z, 2, or 2Z	Purple	None	None	Ball
9x20R				
1, 1Z, 2, or 2Z	Purple	None	None	Ball
11.43x19R				
2, 4, 5, 6, or 6Z	Purple	None	None	Ball
12.7x80SR				
F1Z, F2, or F2Z	Green	None	None	Semi-AP
FG1Z, FG2, or FG3Z	Green	None	None	Semi-AP-T
W1 or W1Z	Green	None	None	AP
B1Z	Blue	None	None	Incendiary
12.7x99				
2Z or 3Z	Purple	None	None	Ball
G2Z	Purple	None	None	Tracer
G5Z or G6Z	Purple	Brown	None	Tracer
W2Z	Green	None	None	AP
B2Z	Blue	None	None	Incendiary
1Z	Purple	Silver	None	API
L11A1 or L11A2	Red	Yellow & Red	None	I-T
L11A2	?	Mustard Yellow	None	I-T practice; inert bullet
13.9x99B				
W1 or W2	Green	None	None	AP

(4) Military cartridges have also been manufactured in the United Kingdom for commercial orders that differ from or have no counterpart in the UK service. Representative samples of these cartridges are tabulated below:

UK Commercial Production

Headstamp identification	Primer annulus color	Bullet tip color	Other feature	Functional type
7.7x56R				
G2Z W1Z B4Z	Red Green Blue	Red Green Blue	None None Step in bullet jacket	Tracer AP Incendiary
8x52R				
-- -- --	Purple Red Black	None Red Silver	None None None	HP ball Tracer API

c. Packaging. Military ammunition is packed in cardboard cartons labeled to indicate contents. Cartons are packed in a sealed sheet-metal case liner, painted black, in a wooden box that is marked to indicate contents by caliber, type, quantity, and stock and lot number. Wooden cases are usually closed by metal straps that can be opened quickly in an emergency.

39. United States

a. Headstamp Marking Practice. Military cartridge headstamp practice combines a producer code with a two-digit year mark and, occasionally, other elements in a two-, three-, or four-element design without segment lines. US producers and their codes are listed below. Many of those listed were wartime plants that are no longer in production. Frankford Arsenal, a major producer for over a century, discontinued production in 1973.

US cartridge producers' codes

<u>Code</u>	<u>Manufacturer</u>
AO	Allegany Ordnance Plant
DEN	Denver Ordnance Plant
DM	Des Moines Ordnance Plant
EC	Evansville Ordnance Plant
ECS	Evansville Ordnance Plant (Evansville-Chrysler-Sunbeam subsidiary)
EW	Eau Claire Ordnance Plant

US cartridge producers' codes (continued)

<u>Code</u>	<u>Manufacturer</u>
FA	Frankford Arsenal
FC	Federal Cartridge Co.
FCC	Federal Cartridge Co.
KS	Allegany Ordnance Plant (Kelly-Springfield Tire Company, contractor)
LC	Lake City Ordnance Plant
LM	Lowell Ordnance Plant
M	Milwaukee Ordnance Plant
PC	Peters Cartridge Company
PCC	Peters Cartridge Company
RA	Remington Arms Company
REM	Remington Arms Company
SL	St. Louis Ordnance Plant
TW	Twin Cities Ordnance Plant
U	Utah Ordnance Plant
UT	Utah Ordnance Plant
W	Western Cartridge Company
WC	Western Cartridge Company
WCC	Western Cartridge Company
WRA	Winchester Repeating Arms Co.

b. Cartridge Type Identification. Ball cartridges in all calibers have no color tips; other types have colored bullet tips as indicated in table XXIV. Most of these bullet tip color codes are in use by NATO and many other countries; variations from this coding system have previously been indicated, when they exist, for the country concerned. In the table, where two colors are shown under "bullet tip color," the first is the tip color and the second is the color band. A recent addition to the NATO color code is a green bullet tip in caliber 5.56x45 only. This color code identifies ball cartridges with heavy bullets

of the Belgian SS109 or US M855 types which require a rifling pitch of about 7 inches (180 mm) for most effective performance.

Table XXIV. Small-Arms Ammunition Color Coding Practice, United States

Bullet tip color	Functional type	7.62 x33	7.62 x51	5.56 x45	7.62x63 (cal. .30 US)	11.43x23 (cal. .45)	12.7x99 (cal. .50)	12.7x77 (BAT)
Black	AP	--	M61	--	M2	--	M2	--
Silver	API	--	--	--	M14	--	M8	--
Blue	Incendiary	--	--	--	M1	--	M1	--
Orange	Tracer	M27	M62	--	M25	--	M10	--
Red	Tracer	M161	--	M196	M1	M26	M1, M21	--
Maroon	Tracer	--	--	--	--	--	M17	--
Green/white	Frangible	--	--	--	M22	--	--	--
Red/silver	API-T	--	--	--	--	--	M20	--
Dark blue/light blue	Incendiary	--	--	--	--	--	M23	--
Yellow/red	Spotter-tracer	--	--	--	--	--	--	M48, M48A1
Green	Ball (SS109 type)	--	--	M855	--	--	--	--

c. Packaging. US small-arms ammunition may be packed in any of several ways: in cardboard cartons, either plain or wax-sealed; in metal-foil envelopes; in hermetically sealed tinfoil cans; or in waterproof metal ammunition boxes. External packaging is either a cleated wooden box or a wirebound box. The ammunition may be bulk-packed; functionally packed in clips in bandoleers; or belted, frequently with mixed functional types, for machinegun use. Each exterior and interior container carries markings that include the Federal stock number, descriptive nomenclature, and quantity. Exterior containers also carry additional storage and shipping data. Boxes containing



20 August 1984

functionally packed ammunition (in clips or belts) have stenciled figure symbols that identify the type of pack. (See TM 9-1305-200 for more complete information.)

#### 40. USSR

##### a. Headstamp Marking Practice.

(1) USSR cartridge headstamps have displayed a variety of layouts and type styles, with raised (relief) headstamps used on 7.62x54R and larger calibers and occasionally on 7.62x25 as well. All 7.62x39 and 9x18 cartridges have impressed headstamps. A two-element layout, with the producer code at 12 o'clock and the year date at 6 o'clock, has been predominant for many years, but other elements may appear, forming three-element or four-element headstamps. When present, these added elements are generally one or two five-pointed stars (though triangles have been used), which may be combined with a letter or numeral. Segment lines saw occasional use in 1944-1945. The producer code is normally a one- to three-digit figure, but one or two Cyrillic letters have also been used. A two-digit numeric year date has been invariable except for the years 1952-1956, when a single Cyrillic letter was used as a year code. Year codes are as follows:

Г = 1952; д = 1953; E = 1954; И = 1955; K = 1956

(2) In the years 1939 to 1946, 7.62x54R cartridges with especially strong cases were made for use only in the ShKAS aircraft machinegun. These cartridges, whose bullet-tip colors follow the normal pattern, are identified by the Cyrillic letter ш in the headstamp. Headstamps B22 and B23 in appendix I show examples of this marking.

b. Cartridge Type Identification.

(1) Cartridges without a color tip are invariably ball cartridges; two models of 7.62x54R ball cartridges, however, as well as specialized functional types in all calibers, are identified by a bullet or bullet tip color coding system that is distinctly different from the US/NATO marking pattern. The Soviet identification system is followed, with some minor local variations, throughout the ECC and indeed wherever ammunition is made for ECC type weapons.

(2) Soviet cartridges are identified as to functional type by a designator, composed of one or more Cyrillic letters indicating the bullet's functional type, and frequently including the year of adoption. Table XXV presents the color coding system in use since the 1930s, together with the bullet-type designators transliterated into English. The Cyrillic abbreviations and their English equivalents are presented in table XXVI.

c. Packaging.

(1) Soviet small-arms cartridges are packed in sealed sheet-metal containers, with two containers in a wooden box. Older Soviet production utilized rectangular containers of heavy-gauge galvanized iron, with soldered seams. More recent practice, introduced about 1959, involves a painted, rolled-edge, round-cornered, tinplate, "sardine can" container.

(2) Metal and wooden containers carry standardized markings that identify the contents as to caliber, functional type (cartridge designator), cartridge case material, quantity, and cartridge and propellant lot data. Specialized cartridges

are further identified by a color code consisting of one or two color stripes corresponding to bullet tip color (fig 33). AP cartridges with tungsten carbide cores are identified by two concentric circles instead of color stripes. Soviet cartridge designation, packaging, and marking practices are generally followed by other ECC; each, however, has introduced some modifications in designation and marking. Soviet ammunition packaging can be distinguished from Bulgarian packaging, which also carry Cyrillic markings, primarily by the difference in producer (factory) code; codes 3, 17, 38, 60, 188, 270, 304, 539, 711, and T are codes that indicate Soviet production. The producer code on the container also appears in the headstamp of the cartridges in the container.

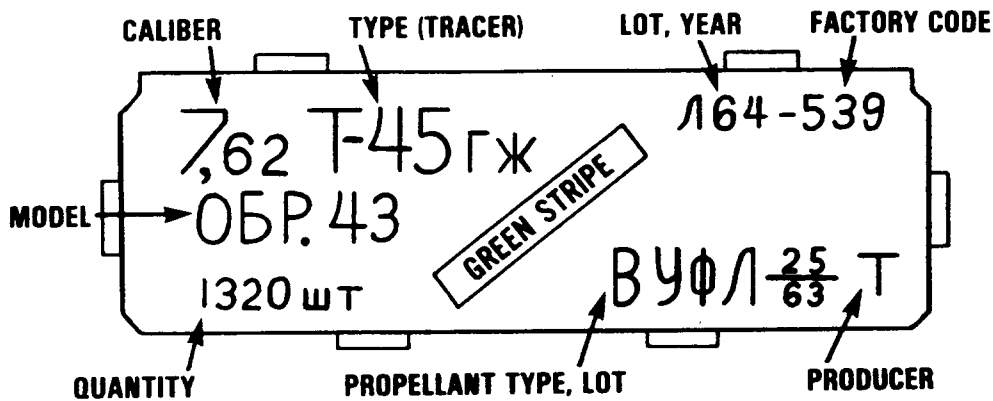

Neg. 524903

Figure 33. Soviet Wood Container Markings,  
7.62x39 Tracer Cartridges, Type T-45

★ Table XXV. Soviet Bullet Tip Color Codes and Bullet Type Designators

Bullet tip color	Functional type	Status	5.45x39	7.62x25	7.62x39	7.62x34R	9x18	12.7x108	14.5x114
None	Ball	Current	PS	P, PST (obsolete)	PS	L	.9P, 9 PST	--	--
Yellow	Heavy ball	Current	--	--	--	D	--	--	--
Silver (white)	Light ball	Current	--	--	--	LPS	--	--	--
Green	Tracer	Current	T	PT (obsolete)	T-45	T-46	--	--	--
Black	AP	Obsolete	--	--	--	B-30	--	B-30	--
Black/red	API	Current	--	P-41 (obsolete; World War II)	BZ	B-32	--	B-32	B-32
Black/yellow	API	World War II	--	--	--	--	--	(Designator unknown)	--
Purple/red	API-T	Current	--	--	--	BZT (obsolete)	--	BZT-44	BZT
Red	I-T (ranging)	Current	--	--	Z	PZ(ZP)	--	--	ZP
Red bullet, purple tip	API-T	Current	--	--	--	--	--	--	BST
Red bullet, black tip	API	Current (BZT only)	--	--	--	BS-40 (obsolete)	--	BS-41 (obsolete)	BS-41 (obsolete); BZT
Green bullet and cartridge	*Reduced velocity ball	World War II	--	--	--	(Designator unknown)	--	--	--
Black/green	*Reduced velocity ball	Current	--	--	US	--	--	--	--
Red bullet w/fuse	HEI	Current	--	--	--	--	--	MDZ	MDZ

\*For silenced weapons; muzzle velocity below 300 m/s.

★Table XXVI. Abbreviations on Soviet Small-Arms  
Ammunition Packaging

Abbreviation	Transliteration	English
Б	B	AP
Б-30	B-30	AP cartridge with 1930 pattern bullet
Б-32	B-32	AP cartridge with 1932 pattern bullet
БС	BS	AP special bullet (core made of tungsten carbide instead of carbon steel)
БС-40	BS-40	AP special cartridge with 1940 pattern bullet
БС-41	BS-41	AP special cartridge with 1941 pattern bullet
БСТ	BST	AP special bullet (core made of tungsten carbide instead of carbon steel) with added tracer
БТ	BT	AP-T
БЗ	BZ	API
БЗТ	BZT	API-T
БЗТ-44	BZT-44	API-T cartridge with 1944 pattern bullet
Д	D	Heavy ball bullet with lead core
Г	G	Year
ГЛ	GL	Brass cartridge case
ГЖ	GZh	Gilding metal clad steel cartridge case
ГС	GS	Lacquered steel cartridge case
Х	Kh	Blank
Л	L	Light (weight)
ЛПС	LPS	Light ball bullet with mild steel core
МДЗ	MDZ	HEI cartridge
ОБР	OBR	Model
П	P	Bullet
П-41	P-41	Cartridge loaded with 1941 pattern bullet
ПС	PS	Ball bullet with mild steel core
ПСТ	PST	Ball bullet with mild steel core
ПТ	PT	Tracer bullet
ПЗ	PZ	Incendiary bullet
Ш	Sh	ShKAS aircraft machinegun
Т	T	Tracer cartridge
Т-45	T-45	Tracer cartridge with 1945 pattern bullet
Т-46	T-46	Tracer cartridge with 1946 pattern bullet
З	Z	Incendiary
ЗП	ZP	Incendiary bullet
ШТ	ShT	Piece, unit, each; quantity in package
УС	US	7.62x39 reduced-velocity cartridge

41. World War II--Germany

a. Headstamp Marking Practice.

(1) From the mid-1930s to the end of the war in 1945, military cartridges produced either in Germany, in occupied countries, or for German military use in other countries, normally utilized an unsegmented four-element layout; rarely, a two-element design is also reported. Headstamps included a producer code designed to conceal the identity and thus location of the producing factory; until 1940, with few exceptions, this code consisted of the letter P, either alone or more usually, followed by two or three digits. From 1940 on, this code was generally replaced by an alphabetic code consisting predominantly of three lower-case letters, less frequently of two letters, and in rare instances, a single letter (k or y). The normal four-element headstamp has the producer code at 12 o'clock. A code at 3 o'clock indicates the case material: St or St + indicates a steel case, either plated or lacquered; a combination of a Roman numeral, a lower-case letter, and an Arabic numeral (for example, VIII b1) identifies a copper-plated steel case; and \* or S\* indicates a brass case. An arc, or curved line, between the producer code and material code indicates that the Berdan primer pocket has just one flash hole rather than two. A lot number appears at 6 o'clock, and a two-digit year code at 9 o'clock.

(2) Well over a hundred letter-type producer codes are known; many of these are reported to reflect production outside of Germany proper. In addition, three-letter codes of wartime German style have been used by Czechoslovakia since the close of the war. In the interest of brevity, the complete listing of World War II codes is not presented here; instead, table XXVIII contains only those letter codes reported to have been used on small-arms ammunition produced in occupied countries or under foreign contract during World War II, or used by Czechoslovakia on postwar production. All codes other than those listed here represent wartime production in Germany.

b. Cartridge Type Identification. Cartridges are identified as to functional type by the presence or absence of a colored primer annulus, bullet tip color, or other feature. The color coding for the principal service cartridges is summarized in table XXVIII. Cartridges packed for use in tropical areas are further identified by a band at the case mouth of the same color as the primer annulus, as well as by the abbreviation (trop) in cartridge nomenclature on package labels.

Table XXVII. World War II and Postwar Letter-Type Manufacturers' Codes

Code	Country	Use
ak	Czechoslovakia	World War II occupation
am	Austria	World War II occupation
auu	Czechoslovakia	World War II occupation
aym	Czechoslovakia	Postwar; 1952-1968
bd	Czechoslovakia	World War II occupation
be	Austria	World War II occupation
bg	Austria	World War II occupation
bxn	Czechoslovakia	Postwar 1953-1964
ch	Belgium	World War II occupation
czo	Czechoslovakia	Postwar; 1956
dou	Czechoslovakia	World War II occupation
dtp	Czechoslovakia	Postwar; 1955
dye	Austria	World War II occupation
eeo	Poland	World War II occupation
jtb	Switzerland	Reported World War II contract production
kam	Poland	World War II occupation
kfg	Yugoslavia	World War II occupation
ksb	France	World War II occupation
kye	Romania	World War II production
kyn	Romania	World War II production
kyp	Romania	World War II production
lkm	Czechoslovakia	World War II occupation
mpr	Switzerland	World War II production
mrb	Czechoslovakia	World War II occupation
ndn	Yugoslavia	World War II production
nfx	Czechoslovakia	World War II occupation
oyj	France	World War II occupation
pjj	Denmark	World War II occupation
wf	Poland	World War II occupation
y	Hungary	World war II production

Table XXVIII. World War II German Small-Arms Ammunition Color Codes and Designators

Primer annulus color	Bullet tip color	Other feature	Bullet type	Designator	Calibers
Green	-	-	Heavy ball	L.S.	7.92x33, 7.92x57
Blue	-	-	Heavy ball (mild steel core)	S.m.E	7.92x33, 7.92x57
Red	-	Black bullet	AP (hard-core)	S.m.K (h)	7.92x33, 7.92x57
Red	Black	-	AP-T	S.m.K L'spur	7.92x33, 7.92x57
Red	-	-	AP	S.m.K	7.92x33, 7.92x57
White	-	-	AP	S.m.K	7.92x57
Black	-	Black bullet	Incendiary	S.P.R	7.92x33, 7.92x57
Black	-	-	API	P.m.K	7.92x33, 7.92x57
-	-	Green stripe on cartridge base	Ball (practice)	L.S.	7.92x33, 7.92x57
-	Black	Green stripe on cartridge base	Tracer (practice)	L.S. L'spur	7.92x57
Black	Chrome	-	Observation	B	7.92x57
Black	-	Rear half of bullet blackened	Observation	B	7.92x57 early manufacturer
Black	-	Not significant	Ball	'08	9x19
Green	-	Green cartridge case	Ball (low velocity)	'08 S	9x19
Green	-	Green cartridge case	Ball (low velocity)	Nah	7.92x57

c. Packaging. Cartridges are packed in cardboard cartons that bear a printed paper label indicating contents. The color of the paper label indicates the functional type: For 7.92x57 cartridges a white label indicates ball and AP cartridges; a yellow label, tracer cartridges; a green label, API; white with a black stripe at the top, explosive cartridges; white with a vertical green stripe, light practice tracer cartridges; divided diagonally in red and white, AP (hard-core); and red-mauve, blank cartridges. An overprint indicates a special pack or restricted use, i.e., cartridges in clips or restricted to use in machine-guns. Cartons may be packed in heavy tagboard intermediate packs or in sealed metal liners. External packing is a hinged wooden box carrying a similar but larger label.

d. Glossary. See table XXIX.



Table XXIX. World War II and Postwar  
Abbreviations and Terms on German  
Small-Arms Ammunition Packaging

Abbreviation	German	English
	Beobachtungspatrone	Observation cartridge
	Brand	Incendiary
Gesch.	Geschoss	Bullet
Gl'spur	Glimmspur	Dim ignition tracer (WW II)
	Hartkern	Hard core (WC alloy)
KB	Kurzbahn	Short range
L.	Ladestreifen	Charger (clip)
	lang	Long
L'spur	Leuchtspur	Tracer
	Manoeverpatrone	Blank cartridge
m.E.	mit Eisenkern	Mild steel core bullet (WW II)
MG	Maschinengewehr	Machinegun
MP	Maschinenpistole	Submachinegun
NZ	Nitrozellulose	Single-base propellant
Patr.	Patrone	Cartridge
Patrh.	Patronenhulse	Cartridge case
	Pistole	Pistol
P.m.K.	Phosphorgeschoß mit Kern	API (WW II)
PP	Pistolenpatrone	Pistol cartridge
S.	Spitzgeschoss	Light pointed bullet (WW II)
S.m.E.	Spitzgeschoss mit Eisenkern	Pointed bullet with iron core (WW II)
S.m.K.	Spitzgeschoss mit Stahlkern	AP bullet with steel core (WW II)
S.m.K.(H)	Spitzgeschoss mit Stahlkern (gehartet)	AP bullet with hardened steel core (WW II)
S.m.K.(H)	Spitzgeschoss mit Stahlkern (gehartet)	Pointed bullet with hardened steel core (WW II)
StbP	Stabchenpulver	Single-perforated grain propellant
StG	Sturmgewehr	Assault Rifle (WW II)
s.S.	schweres Spitzgeschoss	Heavy pointed ball bullet (WW II)
	Treibladung	Propellant
Ub	Ubung	Practice
Zdh.	Zundhutchchen	Primer

42. Yugoslavia

a. Headstamp Marking Practice. From 1949 to the mid-1950s, Yugoslavia followed Soviet practice, using a four-element layout with producer code 11, 12, or 14 at 12 o'clock, stars at 3 and 9 o'clock, and a two-digit year date at 6 o'clock. Since 1956, the numeric producer code has been dropped in favor of a two-letter, three-letter, or four-letter abbreviation in Roman or Cyrillic letters. Codes EIGN, PP-YU, PPU, PP, and IK are known, as well as the Cyrillic forms for IK, PG, and PPU: ИК, ПГ, ППУ. Headstamps on sporting cartridges generally carry a caliber designation rather than a year date.

★ b. Cartridge Type Identification. Both ECC and free world (US) calibers are produced. Cartridges are identified as to functional type by bullet tip color; ECC calibers follow the Soviet color coding pattern, whereas US calibers are identified in most cases by the US color tip code. Cartridges in US calibers having Soviet bullet tip colors are known to exist.

c. Packaging. Cartridges are packaged in cardboard cartons that carry a printed label in either Cyrillic or Roman (Western) alphabet that identifies the contents as to type, quantity, and lot. Yugoslav production can be identified by the word "KOMADA," abbreviated "KOM," for "quantity in package," and the word "METAK" for cartridge. The Yugoslav version of the Cyrillic alphabet utilizes letters not found in either Russian or Bulgarian; the presence of any of the following letters is a positive indication of Yugoslav origin:

Ђ, Ј, Љ, Њ, Ћ, Ќ

d. Glossary. See table XXX.

Table XXX. Abbreviations and Terms on Yugoslav  
Small-Arms Ammunition Packaging

Abbreviation	Cyrillic	Roman	English
КОМ.	БАРУТ ЧАУРА (ЧАУРОМ, ФИШЕК КОМАДА	barut čaura fišek komada	Propellant Cartridge case Cartridges Each; quantity in package
	МЕТАК МИТРАЛЈЕЗ ОБИЧНИМ	metak mitraljez običnim	Cartridge Heavy machinegun Ordinary (ball) cartridge
СЕР.	ПИШТОЉ СЕРИЈА	pistolj serija	Pistol Production lot (number)
	ТЕШКИМ ЗРНОМ	teškim zrnom	Heavy Bullet

APPENDIX I

CARTRIDGE HEADSTAMP IDENTIFICATION GUIDE

---

1. General

a. This appendix provides a recognition guide that presents representative headstamp markings primarily of military cartridges, but including some commercial headstamps that may be found on military caliber cartridges from the 1930s to the present. These headstamps do not represent all the variations that will be encountered, but they provide examples of many producers' marks and headstamp arrangements that will assist in identification of a cartridge as to its country of origin. Variations in layout and in year, caliber, and other markings are to be expected. This appendix should be used in conjunction with the instructions in section II and the information in sections III and IV of this guide.

b. The NATO mark, a cross within a circle, in a military cartridge headstamp indicates that the cartridge in question conforms to a stated NATO specification; this mark can be found on 9x19 and 7.62x51 cartridges that have been made since 1954. The absence of this mark on cartridges in these calibers indicates only that such cartridges may differ in cartridge case or bullet construction or in propellant loading from the NATO specifications.

c. All headstamps are impressed (stamped), unless indicated as "raised," or as "impressed or raised." The year or years indicated in the caption represent the known or reported years of use of the producer's mark or headstamp style; it is emphasized that years other than those shown may be found.

2. Organization

Cartridge headstamps are indexed in four annexes to this appendix, in accordance with the primary identification element. For the user's convenience some headstamps will be found in more than one annex. Notes will be found at the end of each annex.

a. Annex A presents headstamps that contain one or more letters of the Western (Roman) alphabet, arranged in alphabetic sequence. These headstamps may also contain numerals, characters, or symbols, but they will be indexed under their Roman letters if any are present. As an exception, headstamps that contain recognizable Roman numerals (such as IX, VI, XII) with a numeric or other producer code will be indexed under the primary identification element.

DST-1160G-514-81-VOL 1  
11 September 1981

b. Annex B presents headstamps that contain letters or numerals of non-Roman alphabet--Cyrillic, Greek, Arabic, Hebrew, or Amharic--as a primary identification element.

c. Annex C presents headstamps containing Oriental characters or miscellaneous symbols as a primary element. They may also contain Western or Roman numerals as a secondary element.

d. Annex D presents headstamps that contain either Western numerals only, or factory (producer) code numbers in Western numerals as a major identification element. These latter marks may also contain as secondary elements symbols, letters, or other numerals such as a year date.

ANNEX A

CARTRIDGE HEADSTAMPS CONTAINING ROMAN ALPHABET LETTERS

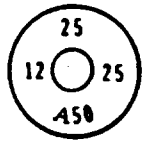

A1 NETHERLANDS

1925-1940.  
See Note 4.

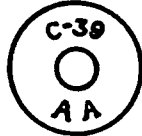

A7 ITALY

A variant of the preceding  
headstamp, dated 1939.  
See Notes 4 and 12.

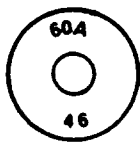

A2 REPUBLIC OF CHINA  
(FORMOSA)

Made at Factory No. 60A.  
The numerals 46 indicate  
manufacture in 1958.



A8 NETHERLANDS

Made by Artillerie  
Inrichtingen, Zaandam.  
1959-1964.  
See Note 4.

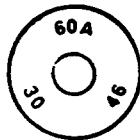

A3 REPUBLIC OF CHINA  
(FORMOSA)

A variant of the preceding  
headstamp.

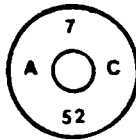

A9 DOMINICAN REPUBLIC

Made at the San Cristobal  
Arms Factory in 1952.

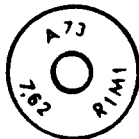

A4 BELGIUM

Made by Fabrique Nationale  
for the Republic of South  
Africa in 1970.

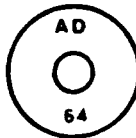

A10 INDONESIA

The letters AD stand for  
Angkatan Darat.  
Made in 1964.

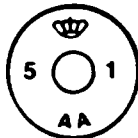

A5 DENMARK

The letters AA stand for  
Ammunitionsarsenalet, in  
Copenhagen. 1951-1953.

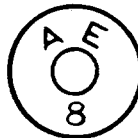

A11 ISRAEL

On 9x19-mm cartridges  
made in 1948.

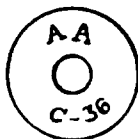

A6 ITALY

Made by Pirotecnico  
Esercito, in Capua, in  
1936.  
See Notes 4 and 12.

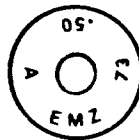

A12 NETHERLANDS

On 12.7x99-mm cartridges  
made by Eurometaal-  
Zaandam in 1973.

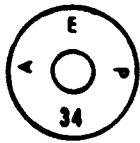

A13 BELGIUM

A E P stands for the manufacturer, Anciens Etablissements Pieper. See Note 4.



A19 SWEDEN

AMF stands for Armeformvaltningen, the army's procurement element. 26 is the army producer code; 42 is year of production. Used from 1921 to 1966. See Note 4.



A14 HUNGARY

Made at Csepel Arsenal, near Budapest. See Note 4.

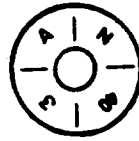

A20 UNITED STATES

Probably made in the 1950s.

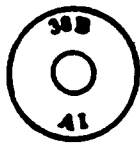

A15 NETHERLANDS

Made by Artillerie Inrichtingen, Zaandam.



A21 JAPAN

On reduced-charge 7.62x51-mm cartridges made by Asahi-Okuma, Ltd., in 1963.



A16 NETHERLANDS

A variant of the preceding headstamp.

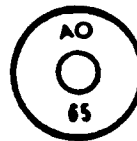

A22 JAPAN

A variant of the preceding mark, used in 1965. See Note 4.

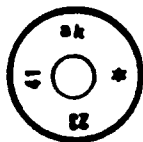

A17 CZECHOSLOVAKIA

Made under German occupation. 1941-1942. See Notes 1 and 4.

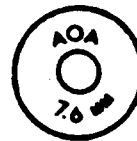

A23 JAPAN

On sporting cartridges made by Asahi-Okuma, Ltd., since 1954. See Note 4.

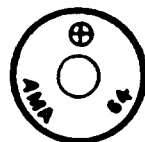

A18 DENMARK

AMA stands for Ammunitionarsenalet, in Copenhagen. Used 1964 and later. See Note 4.



A24 ITALY

Believed to be a code for BPD (Bombrini-Parodi-Delfino). On cartridges reportedly made on contract for Egypt in 1952.



A25 FRANCE  
A typical 8x50.5R (Lebel) marking from 1904 to approximately 1930. See Notes 2 and 4.

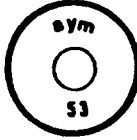

A31 CZECHOSLOVAKIA  
1952-1968.  
See Note 1.

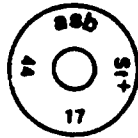

A26 GERMANY  
A typical World War II ammunition code marking. See Note 1.



A32 NORWAY  
On cartridges made at Raufoss Ammunisjonsfabrik in 1954. See Note 4.

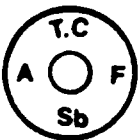

A27 TURKEY  
T.C stands for Turkiye Cumhuriyet, or Turkish Republic. A F indicates production by the military ammunition factory. This headstamp is known from the early 1950s. See Note 4.

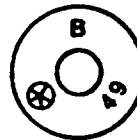

A33 CHINA  
1949.  
See Note 4.



A28 FRANCE  
1942-1948.  
See Note 2.

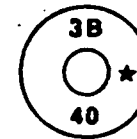

A34 SOVIET UNION  
The letters are the Cyrillic letters ZV. Also found without the star. 1933-1941.

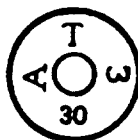

A29 YUGOSLAVIA  
The letters are the Cyrillic letters A T Z. 1930.

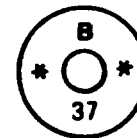

A35 ITALY ?  
On 12.7x81SR cartridges made in 1937.

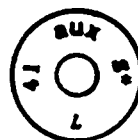

A30 GERMANY  
World War II. 1941-1944. See Note 1.

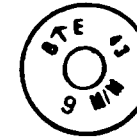

A36 UNITED KINGDOM  
Made at Ministry of Supply factory, Swynnerton, Blackpool. 1943. See Note 3.





A37 ITALY  
Made by L. Beaux, Milan,  
ca. 1935-1955.  
See Note 4.

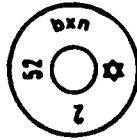

A43 CZECHOSLOVAKIA  
Both impressed and raised  
headstamps, in several  
variations using this  
letter code, are known.  
1951-1964.

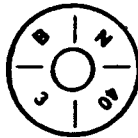

A38 UNITED STATES  
Probably made in the  
1950s.

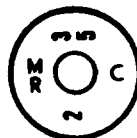

A44 FRANCE  
Made in 1935.  
See Note 2.

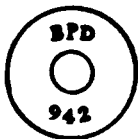

A39 ITALY  
Made by Bombrini-Parodi-  
Delfino. Both impressed  
and raised headstamps are  
known. May have a two-  
digit year marking.  
1942-1957.  
See Note 4.

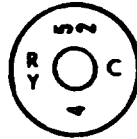

A45 FRANCE  
1952-1953.  
See Note 2.



A40 ITALY  
Made by Bombrini-Parodi-  
Delfino. 1970.

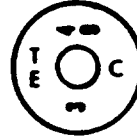

A46 FRANCE  
1939-1955.  
See Note 2.

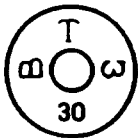

A41 YUGOSLAVIA  
These are Cyrillic  
letters V T Z.  
1930-1933.

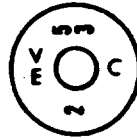

A47 FRANCE  
1950-1953.  
See Note 2.

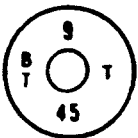

A42 SWITZERLAND  
Made in 1945.

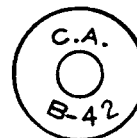

A48 ITALY  
Made by Pirotecnico di  
Bologna, 1939-1942. Also  
found with raised  
headstamp.  
See Note 12.

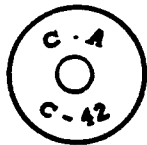

A48-1 ITALY  
Made by Pirotecnico di Capua in 1942. Raised headstamp.  
See Note 12.

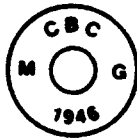

A54 BRAZIL  
The letters CBC stand for Companhia Brasileira de Cartuchos; the MG for Ministro de Guerra.  
See Note 4.



A49 NEW ZEALAND  
1939-1968.  
See Notes 3 and 4.

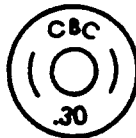

A55 BRAZIL  
On 7.62x63-mm cartridges.  
Probably 1940-1950.  
See Note 4.



A50 NEW ZEALAND  
Cartridges made for Forest Service use.  
ca. 1970.



A56 MEXICO  
Commercial cartridges,  
ca. 1970.  
See Note 4.

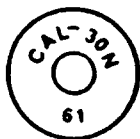

A51 DOMINICAN REPUBLIC  
1961.

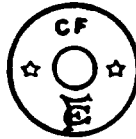

A57 FRANCE  
Commercial production by Cartoucherie Française,  
ca. 1930.  
See Note 4.



A52 YUGOSLAVIA  
Made at Prvi Partizan plant at Titovo Uzice in 1966.

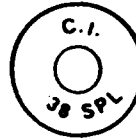

A58 MEXICO  
On cartridges of commercial production.  
Probably in the 1960s.  
See Note 4.

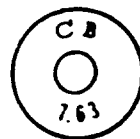

A53 BELGIUM  
The letters stands for Cartoucherie Belge. On 7.62x25-mm cartridges for 7.63-mm Mauser pistol.



A58-1 SPAIN  
Made by Consorcio de Industrias Militares (CIM) at Fabrica Nacional de Toledo, 1932-1936.



A58-2 SPAIN

Made by Consorcio de Industrias Militares (CIM) at Pirotecnia de Sevilla, 1932-1936.

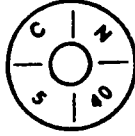

A64 UNITED STATES

Probably made in the 1950s.



A59 SPAIN

Made by Consorcio de Industrias Militares (CIM) at Pirotecnia de Sevilla in 1934.

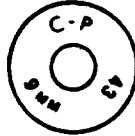

A65 UNITED KINGDOM

Made by Crompton Parkinson Co., Ltd., at Doncaster, York. 1943. See Note 4.



A60 SINGAPORE

On 5.56x45-mm cartridges, the letters FI are a year code for 1969.

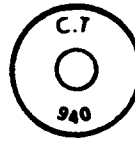

A66 ITALY

Made at the Campo Tizzoro plant of Societa Metallurgica Italiana in 1940.



A61 ROMANIA

1939-1942.

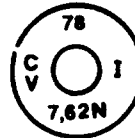

A67 FRANCE

On 7.62x51 cartridges made on contract for the Republic of Upper Volta.

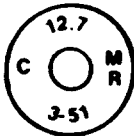

A62 FRANCE

1951. See Note 2.

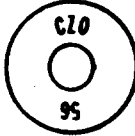

A68 CZECHOSLOVAKIA

Postwar production. On a 12.7x108 cartridge, dated 1956.

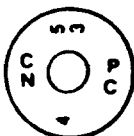

A63 FRANCE

1931-1953. See Note 2.

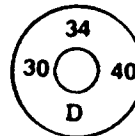

A69 NETHERLANDS

1930-1940. See Note 4.

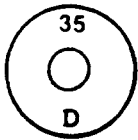

A70 NETHERLANDS  
1935.

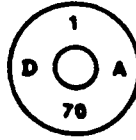

A76 SWITZERLAND  
1941-1970.  
See Note 4.

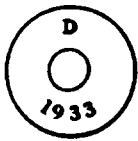

A71 GERMANY  
Commercial manufacture by  
Gustav Genschow and Co.  
at Durlach. 1933.  
See Note 4.

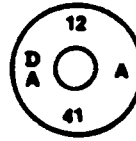

A77 SWITZERLAND  
1941.

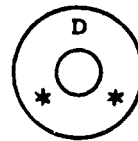

A72 GERMANY  
On commercial pistol  
cartridges made by Gustav  
Genschow and Co. at  
Durlach before World  
War II.

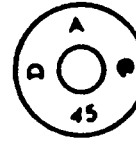

A78 CANADA  
See Notes 3 and 4.



A73 CHINA  
1950-1951.

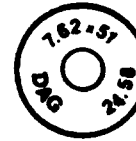

A79 GERMANY  
1950-1976.  
See Note 4.

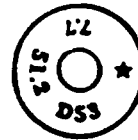

A74 CHINA  
1951.  
See Note 4.



A80 BRAZIL  
DAM stands for Diretoria  
da Marinha, or Navy; MM  
for Ministry of Marine.  
1973.  
See Note 4.

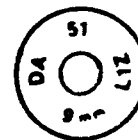

A75 CANADA  
1951.  
See Note 3.



A81 CANADA  
See Notes 3 and 4.



A82 CANADA  
Commercial manufacture by  
Dominion Cartridge Co. to  
1948.  
See Note 4.

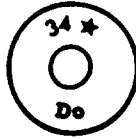

A88 NETHERLANDS  
1934.



A83 UNITED STATES  
Denver Ordnance Plant.  
1941-1944.  
See Note 4.

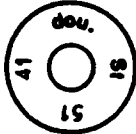

A89 CZECHOSLOVAKIA  
Made under German  
occupation. 1941-1944.  
See Note 4.



A84 CANADA  
Dominion Industries, Inc.  
1941-1944.  
See Notes 3 and 4.

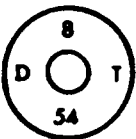

A90 SWITZERLAND  
1954-1969.  
See Note 4.

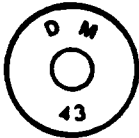

A85 UNITED STATES  
Des Moines Ordnance Plant.  
1941-1945.  
See Note 4.



A91 GERMANY  
Deutsche Waffen und  
Munitionsfabriken.  
1930-1940.  
See Note 4.



A86 GERMANY  
On commercial cartridges  
by Deutsche Waffen-und  
Munitionsfabriken, before  
World War II.  
See Note 4.

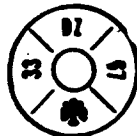

A92 POLAND  
1933-1937.  
See Note 4.

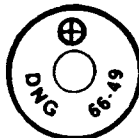

A87 GERMANY  
Dynamit-Nobel-Genschow  
A/G, 1962-1966.

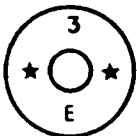

A93 SOVIET UNION  
Letter code indicates  
production in 1954, at  
Factory No. 3.  
See Note 4.

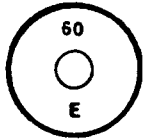

A94 SOVIET UNION

Letter code indicates production in 1954, at Factory No. 60. See Note 4.



A100 UNITED STATES

Evansville Ordnance Plant, Evansville, Indiana. On 11.43x23 (.45 ACP) and 7.62x33 (.30 carbine) cartridges, 1943-1944.

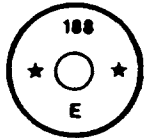

A95 SOVIET UNION

Letter code indicates production in 1954, at Factory No. 188. See Note 4.

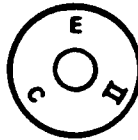

A101 UNITED KINGDOM

Eley Brothers, Ltd. Date of manufacture unknown. See Note 3.

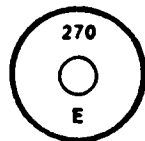

A96 SOVIET UNION

Letter code indicates production in 1954, at Factory No. 270. See Note 4.

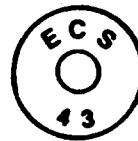

A102 UNITED STATES

On caliber .45 cartridge cases made by Evansville Chrysler-Sunbeam Corp., and loaded at the Evansville Ordnance Plant. 1943-1944.

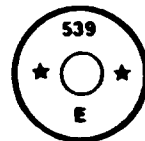

A97 SOVIET UNION

Letter code indicates production in 1954, at Factory No. 539. See Note 4.



A103 YUGOSLAVIA

On 12.7x99-mm cartridges made in 1966.



A98 JAPAN

The character shown reads YO, and indicates manufacture at Yokosuka Naval Arsenal. 1937-1942.



A104 GREECE

1940.



A99 NORWAY

Raufoss Ammunition Plant. 1957.

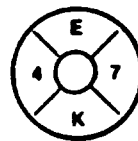

A105 SWEDEN

The letter E indicates a substitute case material (steel); the letter K indicates manufacture at Karlskrona Naval Arsenal. 1944-1947.



A106 GREECE  
1915-1952.



A112 CHILE  
On 9x17-mm pistol  
cartridges. The W stands  
for Walther.  
See Note 4.



A107 GREECE  
1938-1940.



A113 CHILE  
1945.  
See Note 4.

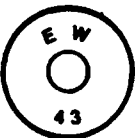

A108 UNITED STATES  
Eau Claire Ordnance Plant,  
Wisconsin.  
1943-1944.

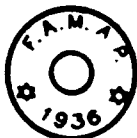

A114 ARGENTINA  
1936-1937.  
See Note 4.



A109 POLAND  
1938.

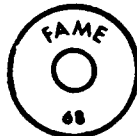

A115 PERU  
1967-1968.  
See Note 4.



A110 UNITED STATES  
Frankford Arsenal,  
Philadelphia. Military  
cartridges were produced  
here until 1973.  
See Note 4.



A116 ARGENTINA  
1941.  
See Note 4.

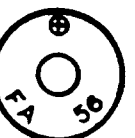

A111 UNITED STATES  
Frankford Arsenal.  
Typical marking on  
7.62x51-mm NATO  
cartridges.  
See Note 4.



A117 UNITED STATES  
Contract production by  
Federal Cartridge Co.  
1960.  
See Note 4.



A117-1 BRAZIL

On cartridges made about 1960 by Fabrica de Cartuchos de Itajuba, in Minas Gerais, Brazil.



A123 ITALY

Commercial production by Giulio FIOCCHI & Co., Lecco, Italy. See Note 4.



A118 PORTUGAL

1943.

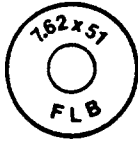

A123-1 ARGENTINA

On an aluminum-case blank 7.62x51 cartridge, ca. 1978.

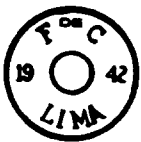

A119 PERU

1942.

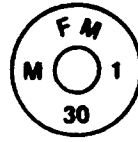

A124 MEXICO

On 7.62x33 (US Cal. .30 carbine) cartridges. See Note 4.

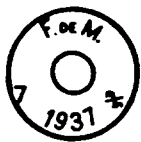

A120 MEXICO

1937.  
See Note 4.

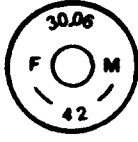

A125 MEXICO

1942.  
See Note 4.

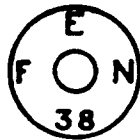

A121 BELGIUM

Produced by Fabrique Nationale for Argentina in 1938. The letter E indicates explosive bullet.

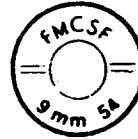

A126 ARGENTINA

1951-1954.  
See Note 4.

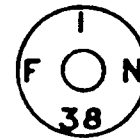

A122 BELGIUM

Produced by Fabrique Nationale for Argentina in 1938. The letter I indicates incendiary bullet.

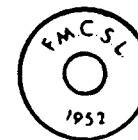

A127 ARGENTINA

1952-1954.  
See Note 4.



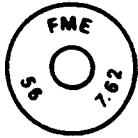

A128 CHILE  
1956.  
See Note 4.

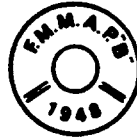

A134 ARGENTINA  
1948.  
See Note 4.

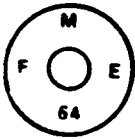

A129 CHILE  
1964.  
See Note 4.



A135 ARGENTINA  
1972-1973.  
See Note 4.

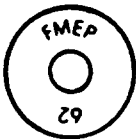

A130 PERU  
1962.



A136 ARGENTINA  
1956.  
See Note 4.



131 ARGENTINA  
1963.  
See Note 4.



A137 BELGIUM  
Made by Fabrique Nationale  
at Herstal in 1948. The  
FN mark has been used  
since the early 1920s.  
See Note 4.



A132 CHILE  
1952-1964.  
See Note 4.

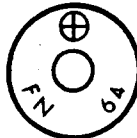

A138 BELGIUM  
Made by Fabrique  
Nationale. 1962-1975.  
See Note 4.

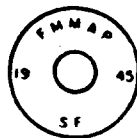

A133 ARGENTINA  
1944-1948.  
See Note 4.

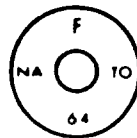

A139 CHILE  
1964.

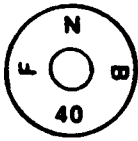

A140 BELGIUM  
Made by Fabrique Nationale. The letter B indicates ball ammunition.  
See Note 4.

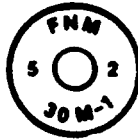

A146 MEXICO  
1952.  
See Note 4.

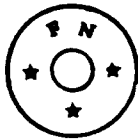

A141 BELGIUM  
Commercial production by Fabrique Nationale.  
See Note 4.

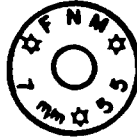

A147 MEXICO  
1955.  
See Note 4.



A142 BELGIUM  
On 7.62x51-mm cartridges made by Fabrique Nationale.

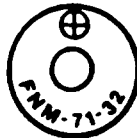

A148 PORTUGAL  
1968-1971.



A143 MEXICO  
1935.  
See Note 4.



A149 SPAIN  
The letters FNP represent Fábrica Nacional de Palencia.  
See Note 4.

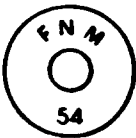

A144 PORTUGAL  
1954.  
See Note 4.

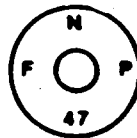

A150 SPAIN  
Fábrica Nacional de Palencia, 1947-1951.

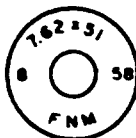

A145 PORTUGAL  
1958.  
See Note 4.

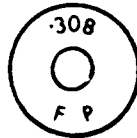

A151 UNKNOWN  
On 7.62x51 cartridges from Central Africa.  
Date unknown.

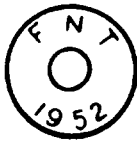

A152 SPAIN

The letters FNT represent  
Fábrica Nacional de  
Toledo. 1946-1954.  
See Note 4.

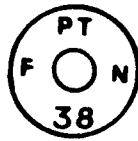

A156 BELGIUM

Made by Fabrique  
Nationale. The letters  
PT indicate AP-T  
bullet. 1938.

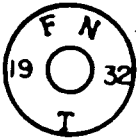

A153 SPAIN

1931-1934.  
See Note 4.

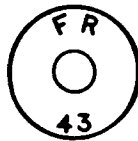

A157 BRAZIL

1943.  
See Note 4.

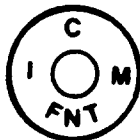

A154 SPAIN

Made by Consorcio de  
Industrias Militares  
(CIM) at Fábrica  
Nacional de Toledo,  
1932-1936.

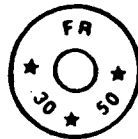

A158 BRAZIL

1950.  
See Note 4.



★A154-1 SPAIN

Made at Fábrica Nacional  
de Toledo, 1947.

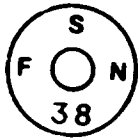

A159 BELGIUM

Made by Fabrique  
Nationale. S indicates  
light flat-based ball  
bullet. 1938.

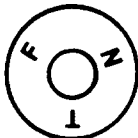

A154-2 SPAIN

Made at Fábrica Nacional  
de Toledo, ca. 1955.

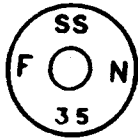

A160 BELGIUM

Made by Fabrique  
Nationale. SS indicates  
heavy boat-tailed ball  
bullet.  
1935.

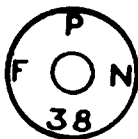

A155 BELGIUM

Made by Fabrique  
Nationale. The letter P  
indicates AP bullet.  
1938.

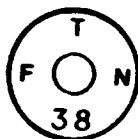

A161 BELGIUM

Made by Fabrique  
Nationale. T indicates  
tracer bullet. 1938.



A162 AUSTRIA  
Made by Hirtenberg for  
Argentina. 1926-1929.

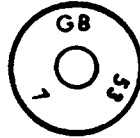

A168 UNITED KINGDOM  
A variant of the preceding  
headstamp. 1953.



A163 GERMANY  
Probably made by Polte  
for Argentina. 1934.



A169 UNITED KINGDOM  
Made by Greenwood and  
Batley, Farnham. 1942.  
See Note 3.

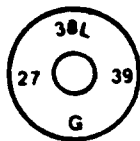

A164 NETHERLANDS  
1939.



A170 SWEDEN  
On 12.7x99 cartridges.  
Year of manufacture  
unknown.  
See Note 4.

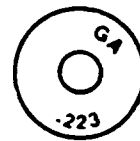

A165 SINGAPORE  
Made after 1960.

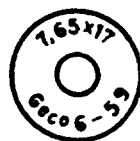

A171 GERMANY  
Commercial cartridges made  
by Gustav Genschow and  
Co., Durlach, in 1959.  
See Note 4.

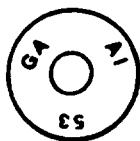

A166 NETHERLANDS  
1953.



A172 FRANCE  
Commercial cartridges made  
by Societé Française de  
Munitions, Paris, formerly  
Gevelot and Gaupillat.  
See Note 4.



A167 UNITED KINGDOM  
Made on contract by  
Greenwood and Batley.  
1941-1949.  
See Note 3.

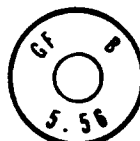

A172-1 SINGAPORE  
On 5.56x45 cartridges. GF  
is the year code for 1976.  
Codes GG (1977) and GH  
(1978) also known.



A173 ITALY  
 Made by Giulio Fiocchi and Co., of Lecco, Italy. See Note 4.

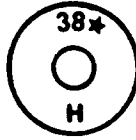

A179 AUSTRIA  
 On military cartridges by Hirtenberger. Probably 1938. See Note 7.



A174 ITALY  
 Made by Giulio Fiocchi and Co., of Lecco, Italy. 1942-1967. See Note 4.

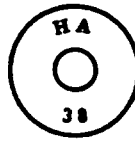

A180 DENMARK  
 On military cartridges by Haerens Ammunitionsarsenal (Army Ammunition Arsenal), Copenhagen. 1938.



A175 AUSTRIA  
 Trade mark of G. Roth of Vienna, before World War II. Many variations of this mark are known.



A180-1 DENMARK  
 On military cartridges made at Haerens Ammunitionsarsenal from 1938 to 1950. See Note 11.



A176 FRANCE  
 On 6.35x15.5SR pistol cartridges made under German occupation in 1944.

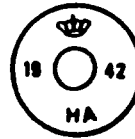

A181 DENMARK  
 Haerens Ammunitionsarsenal. Also with two-digit year date. Used 1938-1950. See Note 11.



A177 FRANCE  
 On 9x20R (.380 revolver) Mk 27 cartridges made for Pakistan by Gevelot SA, Paris. 1959-1960.

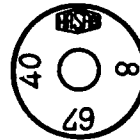

A182 GERMANY  
 Made in Poland in 1940 under German occupation.



A178 AUSTRIA  
 Commercial cartridges by Hirtenberger Patronen, Zundhutschen, and Metallwarenfabrik. See Note 7.



A183 GERMANY  
 On plastic blank cartridges. 1959.

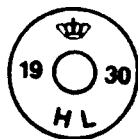

A184 DENMARK  
On cartridges made at  
Haerens Labororium from  
1900 to 1937.  
See Note 4.

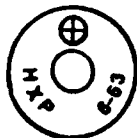

A188 GREECE  
Made by Greek Powder and  
Cartridge Co. 1955-1976.  
See Note 4.



A184-1 DENMARK  
On cartridges made at  
Haerens Labororium from  
1912 to 1937.  
See Note 11.



A189 AUSTRIA  
1934-1938.  
See Note 4.

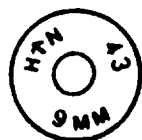

A185 UNITED KINGDOM  
Made at R.O.F. Hirwann.  
1943-1945.  
See Note 3.

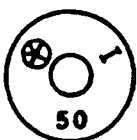

A190 CHINA  
See Note 4.

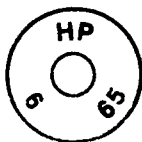

A186 AUSTRIA  
Made by Hirtenberger  
Patronen, Zundhutchchen,  
und Metallwarenfabrik.  
1965.  
See Note 4.



A191 GERMANY  
1965.

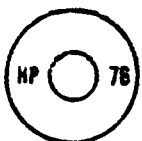

A186-1 AUSTRIA  
A variant of the preceding  
mark. 1976.

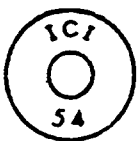

A192 UNITED KINGDOM  
Made by Imperial Chemical  
Industries, Ltd. 1954.  
See Note 4.

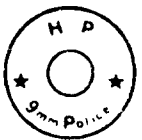

A187 AUSTRIA  
Commercial manufacture,  
ca. 1975.  
See Note 10.

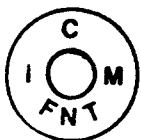

A192-1 SPAIN  
Made by Consorcio de  
Industrias Militares (CIM)  
at Fabrica Nacional de  
Toledo, 1932-1936.  
Compare A58-1.

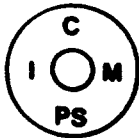

A193 SPAIN  
Made by Consorcio de Industrias Militares (CIM) at Pirotecnia Militar de Sevilla, 1932-1936. Compare A58-2.



A199 ARGENTINA  
Made by Industria Metallurgica y Plastica, Argentina. 1943-1946.

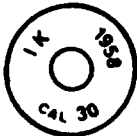

A194 YUGOSLAVIA  
Made at the Igman Plant at Konjic. 1956-1960. See Note 4.

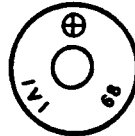

A200 CANADA  
Made by Industries Valcartier, Inc. 1968-1972. See Note 4.

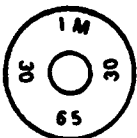

A195 COLOMBIA  
The letters IM stand for Industria Militar. 1965. See Note 4.

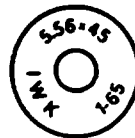

A201 GERMANY  
Made by Industrie Werke Karlsruhe, formerly DWM. 1964-1965. See Note 4.



A196 ISRAEL  
Made for export by Israeli Military Industries. 1967-1975. See Note 4.



A202 JAPAN  
Made by Asahi-Okuma, Ltd. 1956-1964.

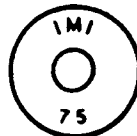

A197 ISRAEL  
A variant of the preceding headstamp. 1975.

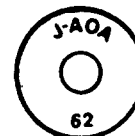

A203 JAPAN  
Made by Asahi-Okuma Arms Corp. 1961-1962.



A198 AUSTRALIA  
Commercial production by Imperial Metal Industries, Ltd. (now Eley). See Note 4.

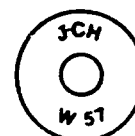

A204 JAPAN  
Made by Chuo-Kayaku-Kako-Kaisha Co. 1957.

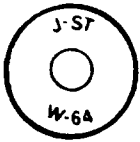

A205 JAPAN  
Made by Showa-Kayaku, Inc.  
at Totsuka. 1960-1964.

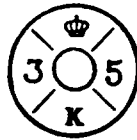

A211 SWEDEN  
Made at Karlsborg. 1935.  
See Note 4.

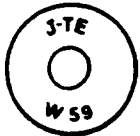

A206 JAPAN  
Made by Toyo Seki, Inc.  
1957-1959.

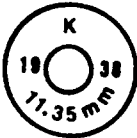

A212 UNITED KINGDOM  
On 11.35x62 Madsen  
machinegun cartridges  
made by ICI, Ltd.  
(Kynoch). 1938.

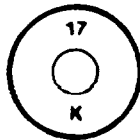

A207 SOVIET UNION  
Letter code for production  
at Factory No. 17. 1956.  
See Note 4.

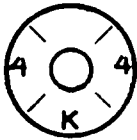

A213 SWEDEN  
Made at Karlsborg. 1944.  
See Note 4.

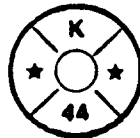

A208 SOVIET UNION  
Made at an unidentified  
factory that used the  
letter code K. 1944.

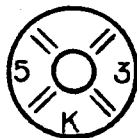

A214 SWEDEN  
On Karlsborg production.  
1945-1956.

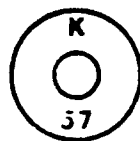

A209 SWEDEN  
Made at Karlsborg  
Ammunition Factory.  
1957-1960.

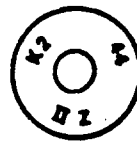

A215 UNITED KINGDOM  
Made at ICI (Kynoch)  
Plant at Standish.  
1943-1944.  
See Notes 3 and 4.

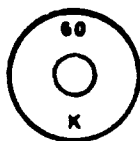

A210 SOVIET UNION  
Letter code for production  
at Factory No. 60. 1956.

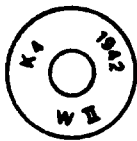

A216 UNITED KINGDOM  
Made at ICI (Kynoch)  
Plant at Yeading.  
1942-1944.  
See Notes 3 and 4.





A217 UNITED KINGDOM  
Made at ICI (Kynoch) Plant  
at Kidderminster. 1944.  
See Notes 3 and 4.

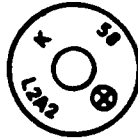

A223 UNITED KINGDOM  
See Note to No. A218.  
1958-1965.  
See Notes 3 and 4.

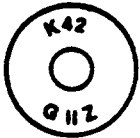

A218 UNITED KINGDOM  
Made at ICI (Kynoch) at  
Witton, Birmingham.  
1939-1966.  
See Notes 3 and 4.

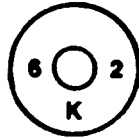

A224 SWEDEN  
Made at Karlsborg. 1962.  
See Note 4.



A219 UNITED KINGDOM  
See Note to No. A218.  
1946.  
See Notes 3 and 4.

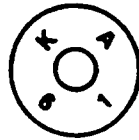

A225 SOUTH KOREA  
On cartridges made at the  
Republic of Korea's 1st  
Arsenal, 1959-1976.

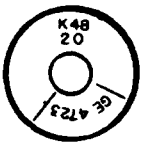

A220 SWEDEN  
On 12.7x99-mm cartridges.  
ca. 1948-1951.



A226 INDIA  
Made at the Kirkee Arsenal  
at Poona. 1957.  
See Note 4.

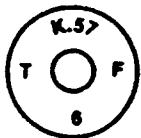

A221 UNITED KINGDOM  
Made for Southern  
Rhodesia. 1957.

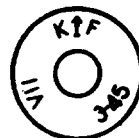

A227 INDIA  
Made at Kirkee Arsenal.  
1940-1945.  
See Notes 3 and 4.

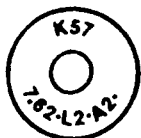

A222 UNITED KINGDOM  
See Note to No. A218.  
1957.  
See Notes 3 and 4.

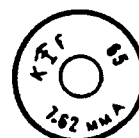

A228 INDIA  
Made at Kirkee Arsenal.  
1951-1974.  
See Note 4.

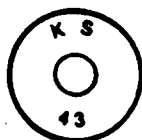

A229 UNITED STATES

Made at Allegany Ordnance Plant, operated by Kelly-Springfield Tire Co., Cumberland, Maryland. 1942-1943.

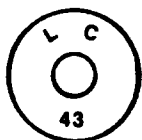

A235 UNITED STATES

Made at Lake City Ordnance Plant, Missouri. 1943-1970.



A230 UNITED KINGDOM

Commercial production. See Note 4.



A236 UNITED STATES

On 12.7x99 (caliber .50) cartridges made by Lowell Ordnance Plant, Mass. 1942-1943.



A231 FINLAND

Made by Lapua in 1949. See Note 4.

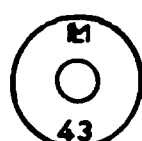

A237 HUNGARY

Made by Magyar Lőszermuvek. 1943. See Note 4.



A232 FINLAND

Commercial production since 1963. See Note 4.



A238 FRANCE

1929-1968. See Note 2.

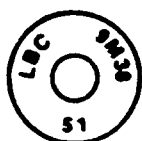

A233 ITALY

Made by Leon Beaux and Co., Milan. 1955-1961. See Note 4.

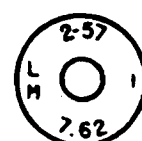

A239 FRANCE

1955-1959. See Note 2.



A234 ITALY

On commercial cartridge production. See Note 4.



A239-1 ITALY

Made by Pirotecnica di Capua in 1934. Raised headstamp. See Note 12.

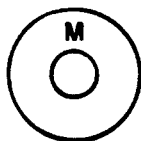

A239-2 SPAIN  
On 9x19 cartridges made by Standard Electrica, Madrid, during the Spanish Civil War, 1936-1939.

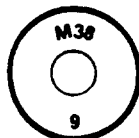

A245 ITALY  
On 9x19-mm cartridges made by an unknown manufacturer, presumably during World War II or earlier.

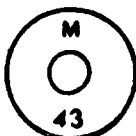

A240 UNITED STATES  
On cartridges made at the Milwaukee Ordnance Plant, Wisconsin. 1942-1943.

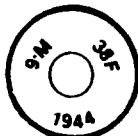

A246 ITALY  
On 9x19-mm cartridges made in 1944 by an unknown manufacturer.



A241 CZECHOSLOVAKIA  
1930-1934.  
See Note 4.

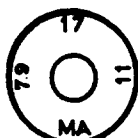

A247 REPUBLIC OF CHINA  
On cartridges captured during the Korean War. Possibly made at Mukden Arsenal in 1929.

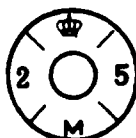

A242 SWEDEN  
Made at Marieberg Arsenal at Kungsholmen, Sweden, 1925-1928.

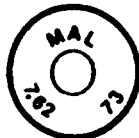

A248 MALAYSIA  
1973.

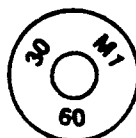

A243 DOMINICAN REPUBLIC  
1960.  
See Note 4.



A249 ITALY  
Commercial cartridges made by Munizioni e Cartucce Martignoni, Genoa.  
See Note 4.

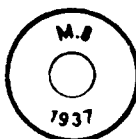

A244 ITALY  
On 8x50.5-mm Mannlicher cartridges made in 1937 by an unknown manufacturer.

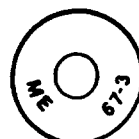

A250 GERMANY  
Made by Maschinenfabrik Elisenhuetten, Nassau.



A251 GERMANY  
Made by Maschinenfabrik  
Elisenhuetten, Nassau.  
1958-1972.  
See Note 4.

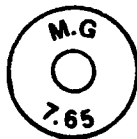

A256 FRANCE  
On 7.65x17SR cartridges  
made by M. Gaupillat &  
Cie, Paris.



A252 SWEDEN  
Made in various calibers.  
See Note 4.



A257 AUSTRALIA  
1940-1949.  
See Notes 3 and 4.



A253 MEXICO  
1930.  
See Note 4.



A258 AUSTRALIA  
1941-1946.  
See Notes 3 and 4.



A254 AUSTRALIA  
1927 to present.  
See Notes 3, 4, and 9.



A259 FRANCE  
1951-1958.  
See Note 2.



A255 SWITZERLAND  
Made at the government  
facility at Altdorf.  
See Note 4.

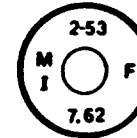

A260 FRANCE  
1953-1968.  
See Note 2.



A255-1 NEPAL  
On 9x19 cartridges. Also  
found on 7.62x51  
cartridges. 1974-1975.



A261 AUSTRALIA  
1942-1946.  
See Note 3.



A262 TURKEY  
1959.  
See Note 4.

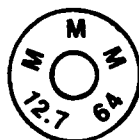

A267 SPAIN  
Made by Manufacturas  
Metalicas Madrilenas.  
1959-1964.  
See Note 4.

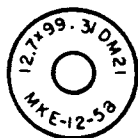

A263 TURKEY  
1959.  
See Note 4.

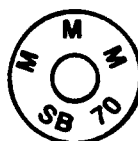

A267-1 SPAIN  
On cartridges loaded by  
Empresa Nacional de Santa  
Barbara at Palencia,  
using cases made by MMM.  
1969-1977.

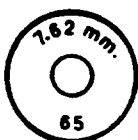

A264 CAMBODIA  
(NOW KAMPUCHEA)  
Also found marked 7.5 mm  
without date. Despite the  
1965 date, cartridges are  
reported made in 1969-1970  
only.

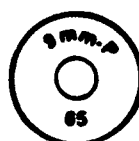

A268 CAMBODIA  
(NOW KAMPUCHEA)  
Despite the 1965 date,  
cartridges are reported  
made in 1969-1970 only.

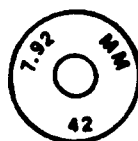

A265 CANADA  
Made for BESA machinegun.  
Also made in 9 mm, for use  
in Sten submachine gun.  
1942-1945.

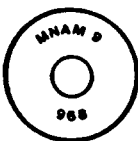

A269 MOROCCO  
Made by Manufacture  
Nationale d'Armes et  
Munitions at Fez, 1964 to  
1968. Other calibers  
also known.  
See Note 4.

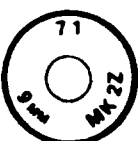

A266 PORTUGAL  
On 9x19 cartridges  
reported manufactured  
for Israel.  
1971.



A270 AUSTRALIA  
1942-1943.  
See Notes 3 and 4.



A266-1 ZIMBABWE  
(RHODESIA)  
On 9x19 cartridges made  
in limited quantity by  
Matthews Mfg. Co., about  
1979.

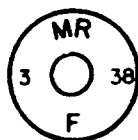

A271 FRANCE  
1932-1938.  
See Note 2.

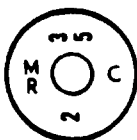

A272 FRANCE  
1928-1938.  
See Note 2.

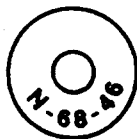

A278 UNKNOWN  
On 7.62x51 cartridges from  
Central Africa. Probably  
made in 1968.

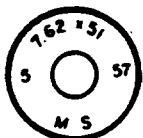

A273 GERMANY  
Made by Manusaar.  
1957-1963.  
See Note 4.



A279 POLAND  
1937-1939.  
See Note 4.

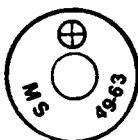

A274 GERMANY  
Made by Manusaar.  
1952-1963.

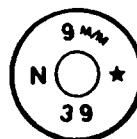

A280 POLAND  
1939.

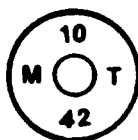

A275 SWITZERLAND  
Made at the government  
facility at Thun.  
1942.  
See Note 4.



A281 POLAND  
Also known with segment  
lines.



A276 AUSTRALIA  
1942-1946.  
See Note 3.



A282 POLAND  
1935-1938.



A277 AUSTRALIA  
Commercial production by  
Myra's Sports Stores,  
Broken Hills, N.S.W.,  
Australia, ca. 1973.  
See Note 4.



A283 SWEDEN  
Commercial manufacture  
by Norma Projekttilfabrik,  
Amotfors.  
See Note 4.

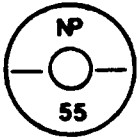

A284 SWEDEN  
 Commercial manufacture.  
 See Note 4.

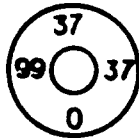

A290 NETHERLANDS  
 1932-1940.  
 See Note 4.

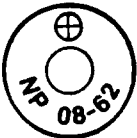

A285 NORWAY  
 Made by Norma  
 Projektilfabrik A/S,  
 Oslo. 1962.

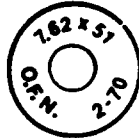

A291 NIGERIA  
 1970.

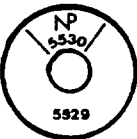

A286 SWEDEN  
 On 12.7x99-mm cartridges.  
 Probably made in 1955.



A292 INDIA  
 On 7.62x51-mm cartridges  
 made at Varangaon Arsenal  
 at Bhusawal. 1965 to  
 present.  
 See Note 4.

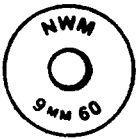

A287 NETHERLANDS  
 Made by Nederland Wapen  
 and Munitiefabrik N.V.  
 1956-1960.  
 See Note 4.

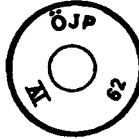

A293 AUSTRIA  
 On cartridges made by  
 Oesterreichisches  
 Jagdpatronenfabrik.  
 1959-1962.

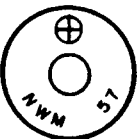

A288 NETHERLANDS  
 A variant of the preceding  
 mark. Made in 1957.

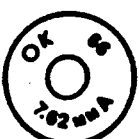

A294 INDIA  
 Made at Khamaria Arsenal  
 at Jubbulpore. 1943-1966.

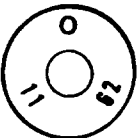

A289 NORWAY  
 On 7.62x51-mm cartridges.  
 1962.



A295 ARGENTINA  
 1942.  
 See Notes 3 and 4.

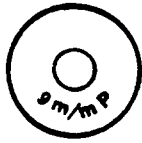

A296 FINLAND

On 9x19-mm cartridges by Sako A/B. Date unknown.

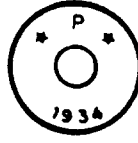

A301 AUSTRIA

On cartridges made by Hirtenberger Patronenfabrik. Also found without the date. 1929-1934. See Note 4.

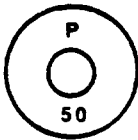

A297 SPAIN

On cartridges made at Fabrica Nacional de Palencia in 1950.

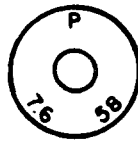

A302 SPAIN

Made at Fábrica Nacional de Palencia, 1958 to 1965. See Note 4.

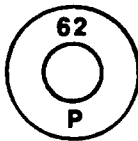

A297-1 JAPAN

On 6.35x15.5 cartridges. The letter P indicates police use. Made in 1962.



A303 GERMANY

1940. See Note 5.

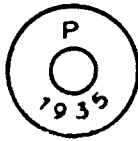

A298 CZECHOSLOVAKIA

On 8x50R-mm cartridges reportedly made by Sellier and Bellot, Prague. 1935.

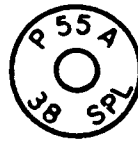

A304 JAPAN

Made by Asahi Okuma Arms Co. in 1955 for police use.

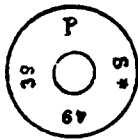

A299 GERMANY

On 7.92x57-mm cartridges made by Polte in Magdeburg. 1937-1939. See Note 4.

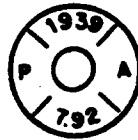

A305 UNIDENTIFIED

On 7.92x57-mm cartridges.

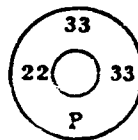

A300 NETHERLANDS

1933. See Note 4.

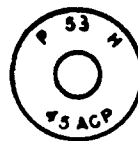

A306 JAPAN

Made by Hokuto Shinko Kabushiki Co. in 1953 for police use.



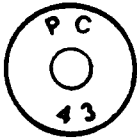

A307 UNITED STATES  
Made by Peters Cartridge  
Co., Ohio. 1941-1944.

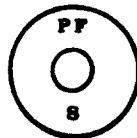

A313 SWITZERLAND  
Made by Patronenfabrik  
Solothurn. Date of  
manufacture unknown.



A308 UNITED STATES  
Made by Peters Cartridge  
Co. for United Kingdom.  
1940.  
See Note 3.



A313-1 SOUTH KOREA  
On pistol cartridges made  
by Poongsan Metal Corp.  
9x19 and 9x29R also made.  
1979-1980.

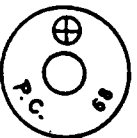

A309 ITALY  
Made by Pirotecnico  
Esercito, Capua. 1968.  
See Note 4.

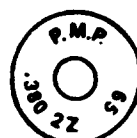

A314 REPUBLIC OF SOUTH  
AFRICA  
Made by Pretoria Metal  
Pressing, Ltd.  
See Note 4.

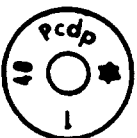

A310 GERMANY  
1940.  
See Notes 1 and 5.

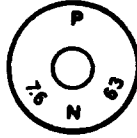

A315 SPAIN  
Made by Fábrica Nacional  
de Palencia. 1963.

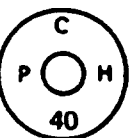

A311 GREECE  
Made by the Greek Powder  
and Cartridge Co., Athens.  
1940.



A316 PAKISTAN  
Made at Pakistan Ordnance  
Factory. 1959-1970.  
See Note 3.



A312 ITALY  
Made by Pirotecnico  
Esercito, Capua.  
1962-1964.  
See Note 4.



A317 YUGOSLAVIA  
Made at Prvi Partizan  
Titovo, Uzice. 1966-1972.  
See Note 4.

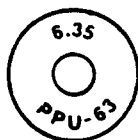

A318 YUGOSLAVIA  
A variant of the preceding mark.  
See Note 4.



A323 SPAIN  
Made by Pirotecnia Militar de Sevilla. 1949-1950.  
See Note 3.

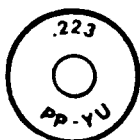

A319 YUGOSLAVIA  
See Note 4.



A324 SOUTH KOREA  
Made by Poongsan Metal Corporation, 1974-1979.

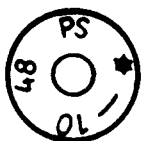

A320 CZECHOSLOVAKIA  
Made by Povazske Strojarnie. 1948-1949.  
See Note 4.

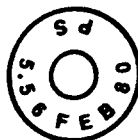

A324-1 SOUTH KOREA  
Made by Poongsan Metal Corporation, 1980.

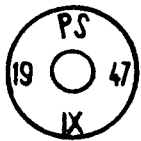

A321 CZECHOSLOVAKIA  
A variant of the preceding mark.

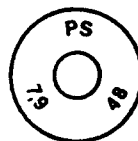

A325 SPAIN  
Made at Pirotecnia Militar de Sevilla. Found on cartridges of several calibers. 1932-1958.  
See Note 4.



A322 JAPAN  
Made by Showa Kinzoku, Ltd., Tokyo, for police use. 1954.

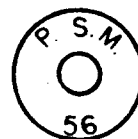

A326 INDONESIA  
Made by Pabrik Sendjasta Mesiu, in Bandung. 1956-1963.



A322-1 SPAIN  
Made by Pirotecnia Militar de Sevilla, in 1944 and 1945.

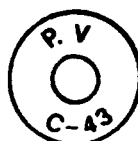

A327 ITALY  
Made by Pirotecnico Esercito, Capua. 1943.

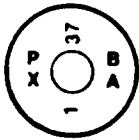

A328 FRANCE  
1937.  
See Note 2.



A334 UNITED STATES  
Made on contract for the  
United Kingdom. 1941.

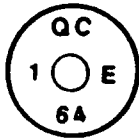

A329 SOUTH VIETNAM  
1964.

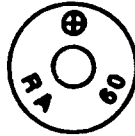

A335 UNITED STATES  
Also found with "9 MM" in  
place of NATO mark. On  
9x19-mm and 7.62x51-mm  
cartridges. 1900-1968.

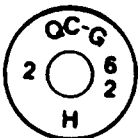

A330 SOUTH VIETNAM  
1962.

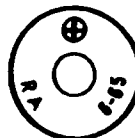

A336 NORWAY  
This and the following  
eight marks appear on  
products of Raufoss  
Ammunisjonsfabrik. 1965.  
See Note 6.



A331 BRAZIL  
Made by Fabrica Realengo.  
1945.  
See Note 4.

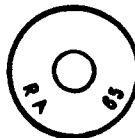

A337 NORWAY  
A variant of the  
preceding mark.  
1963-1965.  
See Note 6.

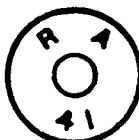

A332 UNITED STATES  
Made by Remington Arms  
Co., Bridgeport, Conn.  
1940-1960.  
See Note 4.

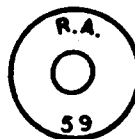

A338 NORWAY  
1959.  
See Note 6.

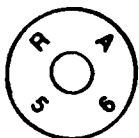

A333 UNITED STATES  
A variant of the  
preceding mark.  
1945-1956.



A339 NORWAY  
1949.  
See Note 6.

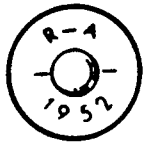

A340 NORWAY  
1937-1952.  
See Note 6.

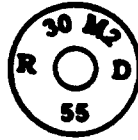

A345 DOMINICAN REPUBLIC  
1955-1959.  
See Note 4.



A341 NORWAY  
1932-1941.  
See Note 6.

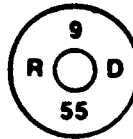

A346 DOMINICAN REPUBLIC  
1955-1958.  
See Note 4.

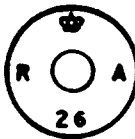

A342 NORWAY  
1926.



A347 UNITED KINGDOM  
Made at R.O.F. plant at  
Radway Green. 1951.  
See Note 3.



A342-1 NORWAY  
On 6.5x55 high-pressure  
test cartridges.



A348 UNITED KINGDOM  
Made by Raleigh Cycle Co.,  
Ltd., Nottingham.  
See Note 3.



A343 NORWAY  
1925.  
See Note 4.



A349 UNITED KINGDOM  
Made at R.O.F. plant at  
Woolwich, London.  
1936-1949.  
See Note 3.

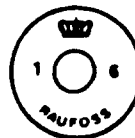

A344 NORWAY  
1959-1960.  
See Note 4.



A350 UNITED KINGDOM  
1956.  
See Note 3.

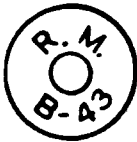

A351 ITALY  
Made by Pirotecnico de  
Bologna. 1943.

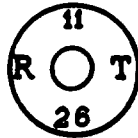

A357 SWITZERLAND  
1926.

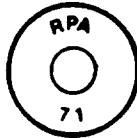

A352 REPUBLIC OF THE  
PHILLIPINES  
1971.

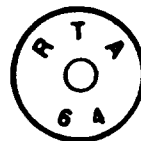

\*A358 THAILAND  
1964-1982.



A353 ROMANIA  
Factory code number 22.  
On 14.5x114 cartridges  
made in 1957.

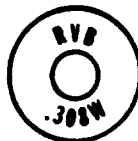

A358-1 AUSTRALIA  
On commercial cartridges  
by Riverbrand Co., which  
merged with Myra's Sport  
Stores in 1977.  
See Note 4.



A354 ROMANIA  
Factory code number 21.  
On 14.5x114 cartridges  
made in 1957.

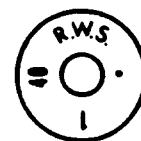

A359 GERMANY  
Made by Rheinisch  
Westfalische Sprengstoff,  
in Nürnberg. 1940.



A355 ROMANIA  
On 7.62x39-mm cartridges.  
1963-1969.

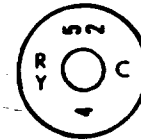

A360 FRANCE  
1952-1953.  
See Notes 2 and 4.



A356 FRANCE  
1928-1956.  
See Note 2.

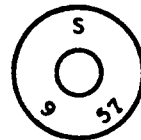

A361 SPAIN  
On 9x19 cartridges by  
Pirotecniã Militar de  
Sevilla, from 1952 to  
present.

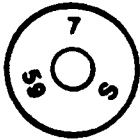

A362 SPAIN  
On 7x57 cartridges. A variant of the preceding mark.  
See Note 4.

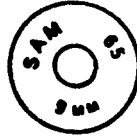

A368 REPUBLIC OF SOUTH AFRICA  
1961-1965.  
See Note 3 for cartridge type codes.

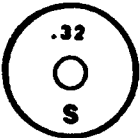

A363 SPAIN  
A third variant of the Sevilla headstamp.  
See Note 4.

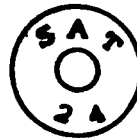

A369 FINLAND  
1924.



A364 FINLAND  
Made by Sako A/B.  
1941.

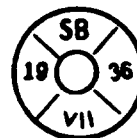

A370 CZECHOSLOVAKIA  
Prewar production by Sellier and Bellot plant at Prague. 1934-1940.



A365 SPAIN  
Made at Cartagena during the Spanish Civil War, 1936-1939.  
See Note 8.

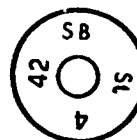

A371 CZECHOSLOVAKIA  
Made under German occupation. 1942.



A366 FINLAND  
Commercial production by Sako A/B.  
See Note 4.

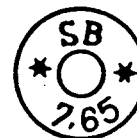

A372 GERMANY  
Made at a branch of the former Sellier and Bellot firm at Schoenbeck/Elbe (now in East Germany) before World War II.  
See Note 4.

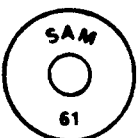

A367 REPUBLIC OF SOUTH AFRICA  
Made by the South African Mint in 1956.  
See Note 4.

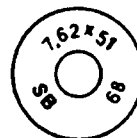

A373 SPAIN  
Made at the Palencia plant of Empresa Nacional de Santa Barbara, 1964-1974.

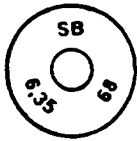

A374 SPAIN  
A variant of the preceding mark, found on cartridges of several calibers. 1962-1970. See Note 4.

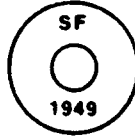

A380 FRANCE  
On 9x19-mm cartridges made in 1949. See Note 2.

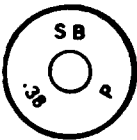

A375 SPAIN  
On 9x20R cartridges made at Palencia. Date of manufacture unknown. See Note 4.

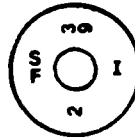

A381 FRANCE  
1939-1959. See Note 2.

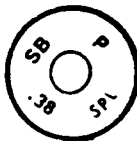

A376 SPAIN  
A variant of the preceding mark. See Note 4.

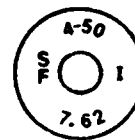

A382 FRANCE  
1950-1973. See Note 2.

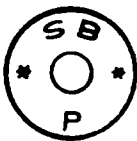

A377 CZECHOSLOVAKIA  
Commercial prewar production by Sellier and Bellot plant at Prague. See Note 4.



A383 FRANCE  
A variant headstamp pattern on an 8x27R revolver cartridge. 1937.

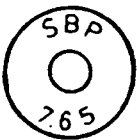

A378 CZECHOSLOVAKIA  
A variant of the preceding mark. See Note 4.

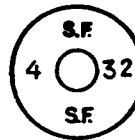

A384 FRANCE  
This pattern of headstamp marking is found only on 13.2x99 cartridges. 1932-1939.

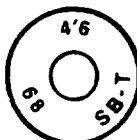

A379 SPAIN  
Made at the Toledo plant of Empresa Nacional de Santa Barbara in 1968. Also marked 7.62x51.



A385 FRANCE  
A typical marking on commercial cartridges produced by Soci t  Fran aise de Munitions (formerly Gevelot and Gaupillat), Paris. See Note 4.

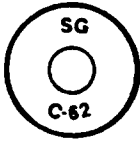

A386 ITALY  
Produced by Pirotecnico  
Esercito, Capua. 1962.

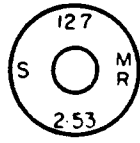

A392 FRANCE  
1953.  
See Note 2.



A387 SINGAPORE  
FG is the year code for  
1967. 1967-1971.  
See Note 4.

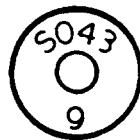

A393 FINLAND  
On cartridges made by  
Sako A/B. 1943-1944.  
See Note 4.



A388 GERMANY  
On commercial cartridges  
by Selve Kronbiegel,  
Dornheim, Soemmerda.  
Date unknown.

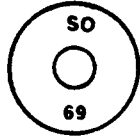

A394 FINLAND  
A variant of the preceding  
mark. 1969.

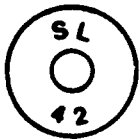

A389 UNITED STATES  
On World War II production  
by St. Louis Ordnance  
Plant, Missouri.  
1942-1944.  
See Note 4.

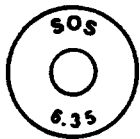

A395 UNKNOWN  
On 6.35x15.5SR pistol  
cartridges. Date  
unknown.

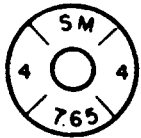

A390 SWEDEN  
On cartridges by Svenska  
Metallverken. 1944.



A396 UNITED KINGDOM  
Made at R.O.F. Spennymoor.  
1942.  
See Note 3.

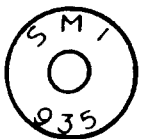

A391 ITALY  
On cartridges by Società  
Metallurgica Italiana.  
1933-1973.  
See Note 4.

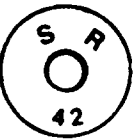

A397 UNITED KINGDOM  
1942.  
See Note 3.



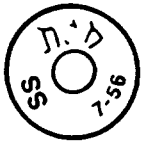

A398 ISRAEL  
1956.  
See Note 4.

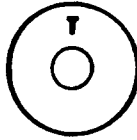

A402-1 SPAIN  
On 7x57 cartridges by  
Standard Electrica SA,  
Madrid, during the  
Spanish Civil War,  
1936-1939.



A398-1 AUSTRALIA  
Commercial production by  
Super Cartridge Pty.,  
Ltd., Victoria, Australia.  
See Note 4.

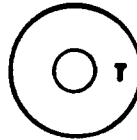

A402-2 SPAIN  
On 7x57 cartridges. A  
variant of the preceding  
headstamp.

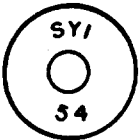

A399 ITALY  
Reportedly used instead of  
SMI on 11.43x23-mm (.45  
ACP) cartridges made in  
1954.

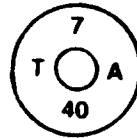

A403 SWITZERLAND  
1940.  
See Note 4.

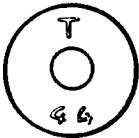

A400 SOVIET UNION  
T is a factory code used  
by Tula Arsenal from 1913  
to the present.  
See Note 4.

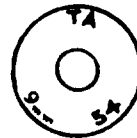

A404 ISRAEL  
Reportely produced at  
Tel Aviv Arsenal for  
export in 1954.  
See Note 4.

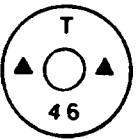

A401 SOVIET UNION  
A variant of the preceding  
mark. 1945-1946.  
See Note 4.

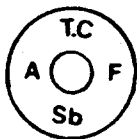

A405 TURKEY  
Refer to note on  
headstamp No. A27.  
See Note 4.

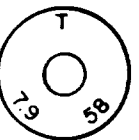

A402 SPAIN  
On cartridges made at  
Fábrica Nacional de  
Toledo, 1956-1958.  
Other calibers known.  
See Note 4.



A406 TURKEY  
1934.  
See Note 4.

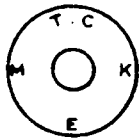

A407 TURKEY  
See Note 4.



A413 FRANCE  
1935.  
See Note 2.

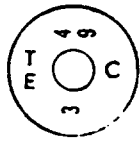

A408 FRANCE  
1927-1955.  
See Note 2.

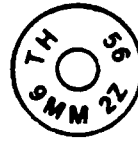

A414 UNITED KINGDOM  
1955-1956.  
See Note 3.

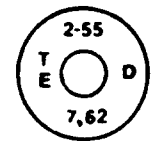

A409 FRANCE  
1955-1961.  
See Notes 2 and 4.

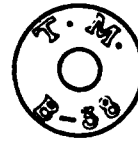

A415 ITALY  
On cartridges produced by  
Pirotecnico di Bologna.  
1935-1939.  
See Note 4.

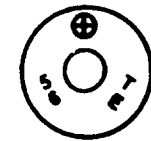

A410 FRANCE  
1956-1970.  
Also known with date and  
producer code reversed.  
See Note 2.

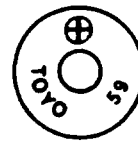

A416 JAPAN  
On military cartridges by  
Toyo Seiki, Ltd. 1959.

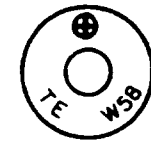

A411 JAPAN  
On military cartridges  
made by Toyo Seiki, Ltd.,  
Tokyo. 1958.

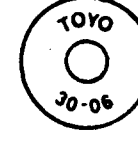

A417 JAPAN  
On sporting cartridges by  
Toyo Seiki, Ltd.  
See Note 4.

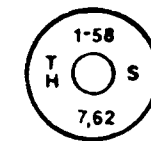

A412 FRANCE  
1958.  
See Note 2.

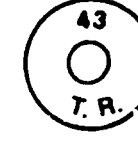

A418 CANADA  
Produced under contract  
by Dominion Rubber and  
Munitions, Ltd., at  
Three Rivers, Quebec.  
1943.

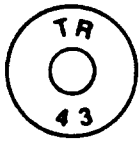

A419 CANADA  
 A variant of the preceding headstamp. 1943.

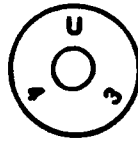

A425 UNITED STATES  
 On cartridges produced at the Utah Ordnance Plant at Salt Lake City, Utah. 1941-1943.

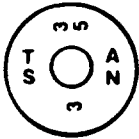

A420 FRANCE  
 1917-1958.  
 See Note 2.

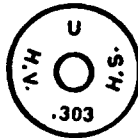

A426 REPUBLIC OF SOUTH AFRICA  
 On sporting cartridges made from 1939 to 1961.

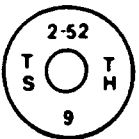

A421 FRANCE  
 1952-1957.  
 See Note 2.

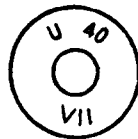

A427 REPUBLIC OF SOUTH AFRICA  
 1938-1960.  
 See Note 3 for cartridge type codes.

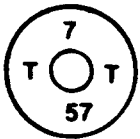

A422 SWITZERLAND  
 Made at the government-owned plant at Thun.  
 See Note 4.

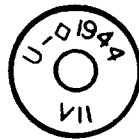

A428 REPUBLIC OF SOUTH AFRICA  
 Produced at Kimberley Branch Mint. 1942-1945.  
 See Note 3 for cartridge type codes.



A423 UNITED STATES  
 Made at Twin Cities Ordnance Plant, Minneapolis, Minnesota. 1942-1943.  
 See Note 4.

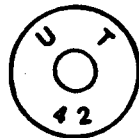

A429 UNITED STATES  
 On cartridges produced at the Utah Ordnance Plant. 1942-1944.  
 See Note 4.

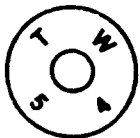

A424 UNITED STATES  
 A variant of the preceding mark. 1954.



A430 FINLAND  
 On commercial cartridges by Valtion Patruunatohdas, Lapua. Date of production unknown.

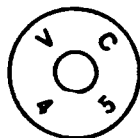

A431 CANADA  
On contract production by  
Defence Industries, Ltd.,  
at Verdun, Quebec. 1945.

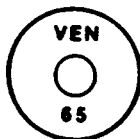

A437 VENEZUELA  
1965.

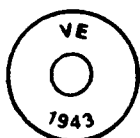

A432 FRANCE  
1943.  
See Note 2.

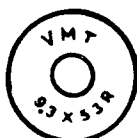

A438 FINLAND  
On commercial production  
by Valtion Metallitehtaa,  
Helsinki.



A433 FRANCE  
1911-1958.  
See Note 2.

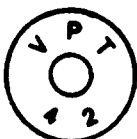

A439 FINLAND  
On military cartridges by  
Valtion Patruunatehdas,  
Lapua. 1929-1963.  
See Note 4.

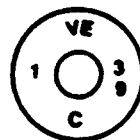

A434 FRANCE  
1935-1939.  
See Note 2.

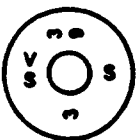

A440 FRANCE  
1915-1956.  
See Note 2.

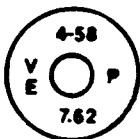

A435 FRANCE  
1958-1962.  
See Note 2.



A441 UNITED STATES  
Made by Western Cartridge  
Co. (now Winchester-  
Western Division, Olin  
Mathieson Chemical Corp).  
1940-1976.  
See Note 4.

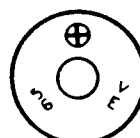

A436 FRANCE  
1956.  
See Note 2.



A442 UNITED STATES  
Made by Winchester  
Repeating Arms Co. (now  
Winchester-Western  
Division, Olin Mathieson  
Chemical Corp).  
1940-1976.  
See Note 4.



A443 GREECE  
Made by the Greek Powder and Cartridge Co., Athens. 1941.



A449 CZECHOSLOVAKIA  
On 7.62x54R cartridges made in 1957. Raised headstamp.



A444 CZECHOSLOVAKIA  
On commercial cartridge made at Zbrojovka Bystrica before 1939. See Note 4.

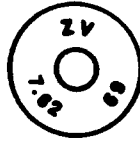

A450 CZECHOSLOVAKIA  
On 7.62x51 cartridges made in 1969.



A445 CZECHOSLOVAKIA  
On military cartridges made at Zbrojovka Bystrica. 1935-1940.

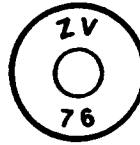

A451 CZECHOSLOVAKIA  
On several calibers of military cartridges, 1956-1976.

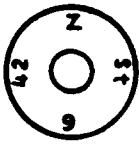

A446 CZECHOSLOVAKIA  
On 7.92x57 cartridges made under German occupation in 1942.



\*A452 ISRAEL  
On 12.7x99 cartridges, 1977. Made by Israel Military Industries. See Note 4.



A447 CZECHOSLOVAKIA  
On postwar production. 1947-1949. See Note 4.

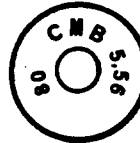

\*A453 BRAZIL  
On 5.56x45-mm cartridges manufactured by Manurhin in France for Brazil. 1980.

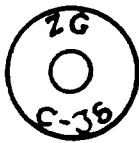

A448 ITALY  
On cartridges made by Pirotecnico de Capua in 1936. Raised headstamp.

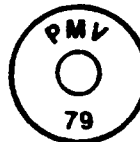

\*A454 CUBA  
On 7.62x39-mm cartridges manufactured in 1979.

Notes to Annex A

- Note 1. Cartridge headstamp markings that contain factory codes consisting of combinations of two or three lower-case letters (or, rarely, a single letter) such as de, edg, or y are described under "World War II--Germany" in section IV of this guide. These marks are normally found in the 12 o'clock position, with a 4x90° layout, but 2x180° layouts with the letters at 6 o'clock are known.
- Note 2. Variations of this headstamp in layout, metal producer, and year are known. For an explanation of marking codes, refer to section IV of this guide under "France."
- Note 3. Various bullet type codes, years, and layouts are known. Refer to section IV of this guide, under "United Kingdom," for manufacturers' and bullet type codes.
- ★Note 4. Variations of this basic headstamp marking are known. "TZZ" will appear on 9x19-mm cartridges produced under contract for the United States.
- Note 5. Other headstamp markings that contain the letter P followed by a letter or numeral code are indexed under "World War II--Germany" in section IV of this guide.
- Note 6. Cartridges produced at Raufoss Ammunisjonsfabrik will have a Berdan primer, whereas those made by Remington will have a Boxer-type primer.
- Note 7. Variations of this basic headstamp are known. Differences in style of star and number of points serve as an internal (Hirtenberger) code indicating year of production.
- Note 8. Variations of this headstamp style in caliber marking and factory code are known. For markings with the letters "S A," refer to section IV B under "Spain."
- Note 9. The letters "M F" followed by a small letter c indicate production for commercial sale at Footscray Arsenal, Australia.
- Note 10. Many caliber marking variations are known. Differences in style of stars and number of points serve as an internal (Hirtenberger) code indicating year of production.
- Note 11. The designation "Haerens Laboratorium" was used for the Danish Army Laboratory at Copenhagen from 1900 to 1937. From 1938 to 1950 the installation was designated "Haerens Ammunitionsarsenal" (Army Ammunition Arsenal). When letters and numbers appear at 12 o'clock, these indicate the case metal provider and year of delivery. See section IV B under "Denmark."
- Note 12. The initials A.A., C.A., or L.N. at 12 o'clock are those of the chief government inspector.

ANNEX B

CARTRIDGE HEADSTAMPS CONTAINING NON-ROMAN ALPHABET LETTERS OR NUMERALS

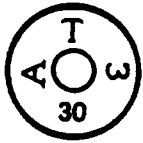

B1 YUGOSLAVIA  
1930.

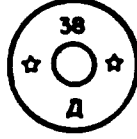

B7 SOVIET UNION  
1953.  
See Notes 1 and 3.



B2 BULGARIA  
1947.

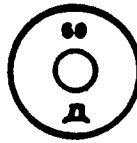

B8 SOVIET UNION  
1953.  
See Note 1.



B3 YUGOSLAVIA  
1933.

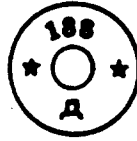

B9 SOVIET UNION  
1953.  
See Notes 1 and 3.

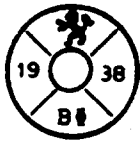

B4 BULGARIA  
1938-1939.

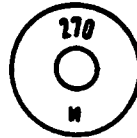

B10 SOVIET UNION  
1955.  
See Note 1.

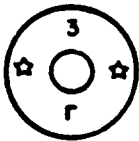

B5 SOVIET UNION  
1952.  
See Notes 1 and 3.

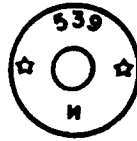

B11 SOVIET UNION  
1955.  
See Notes 1 and 3.

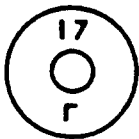

B6 SOVIET UNION  
1952.  
See Note 1.

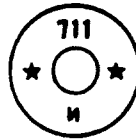

B12 SOVIET UNION  
1955.  
See Notes 1 and 3.

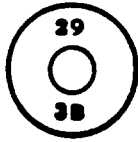

B13 SOVIET UNION  
Factory code ZV.  
1929.

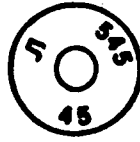

B19 SOVIET UNION  
1945.

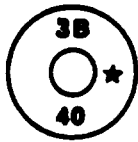

B14 SOVIET UNION  
Factory code ZV. Also is  
found without the star.  
1933-1941.



B20 YUGOSLAVIA  
Also found with two-digit  
year code. 1960-1967.



B15 GREECE  
Greek Power and Cartridge  
Co. 1940-1952.  
See Note 4.



B21 YUGOSLAVIA  
Made at Prvi Partizan  
Titovo, Udice. Also  
found with two-digit year  
code. 1959-1972.



B16 GREECE  
Greek Power and Cartridge  
Co. 1938-1940.  
See Note 4.



B22 SOVIET UNION  
1940.  
See Note 2.

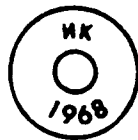

B17 YUGOSLAVIA  
Made at the Igman plant  
at Konjic. 1967-1968.

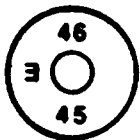

B23 SOVIET UNION  
1940-1945.  
See Note 2.

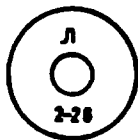

B18 SOVIET UNION  
Factory code L.  
1924-1927.



B24 EGYPT  
Made at the Shoubra  
Ammunition Plant near  
Cairo. 1954.





**B25 EGYPT**  
On 7.92x57 cartridges. 1954-1956. The Arabic name for Egypt, "Misr," is at 12 o'clock.



**B31 EGYPT (ARAB REPUBLIC OF EGYPT)**  
On several calibers of cartridges made at Factory No. 27. 1972-1973.



**B26 EGYPT**  
On several calibers of cartridges. 1957-1958.



**B31-1 EGYPT (ARAB REPUBLIC OF EGYPT)**  
On 7.62x54R cartridges made at Factory No. 10 in 1976.

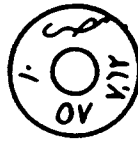

**B27 EGYPT**  
On 7.62x54R cartridges made at Factory No. 10. 1957-1958.

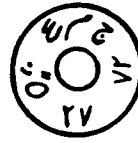

**B32 EGYPT (ARAB REPUBLIC OF EGYPT)**  
On 12.7x99 (US cal. .50) cartridges made at Factory No. 27. 1972.

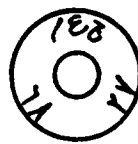

**\*B28 EGYPT (UNITED ARAB REPUBLIC)**  
On several calibers of cartridges made at Factory No. 27. 1959 to present.



**B33 SYRIA**  
On 7.5x54 cartridges; other calibers also exist. The Arabic letters MMD indicate manufacture at Damascus. 1956-1957.



**B29 EGYPT (UNITED ARAB REPUBLIC)**  
On 7.62x54R cartridges made at Factory No. 10. 1969-1971.

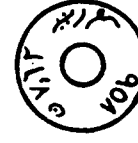

**B34 SYRIA**  
On 7.62x51 (NATO type) cartridges. 1958.

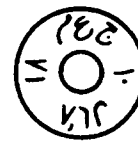

**B30 EGYPT (UNITED ARAB REPUBLIC)**  
Variant of preceding mark. 1969-1972.

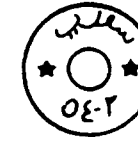

**B35 SYRIA**  
On 7.5x54 cartridges. 1954. See Note 4.



**B36 SYRIA**  
On 7.62x51 (NATO type) cartridges. Found with various caliber designations at 12 o'clock. 1954 to present. See Note 4.



**B42 IRAQ**  
1936-1961.

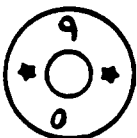

**B37 SYRIA**  
A variant of the preceding mark. On 9x19 (Parabellum) cartridges. 1959-1961.



**B43 IRAQ**  
1964.



**B38 SYRIA**  
Another variant of the preceding mark. On 7.6x54 cartridges. 1971-1972. Also found with 7.62x39 marking. 1972 to present.



**B44 LEBANON**  
Identified by the Cedar of Lebanon. The Arabic letters MMD indicate manufacture at Damascus. See Note 4.



**B39 SYRIA**  
On 7.62x54R cartridges. The Arabic letters at upper left stand for long cartridge. 1962-1963.



**B45 SAUDI ARABIA**  
Identified by the palm tree and crossed swords. 1954 to present. See Note 4.



**B40 IRAQ**  
Identified by the delta mark. 1949.



**B46 IRAN**  
1951-1968. See Note 4.



**B41 IRAQ**  
1949. See Note 4.

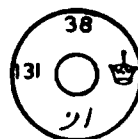

**B47 IRAN**  
1960.



B48 IRAN  
On 7.62x63 and 7.92x57  
cartridges. 1968.

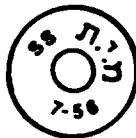

B54 ISRAEL  
1956.



B49 IRAN  
On 7.62x51 (NATO type)  
cartridges. 1970.



B55 ISRAEL  
1956 to present.

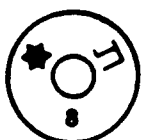

B50 ISRAEL  
1958?

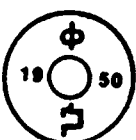

B56 ETHIOPIA  
1950.



B51 ISRAEL  
1949-1954.  
See Note 4.



B57 ETHIOPIA  
1954-1967.  
See Note 4.



B52 ISRAEL  
1951.  
See Note 5.

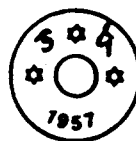

B58 ETHIOPIA  
1957.

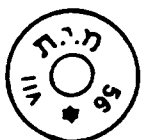

B53 ISRAEL  
1955-1956.

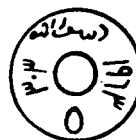

B59 SUDAN  
On 7.7x56R cartridges.  
1963.



B60 SUDAN  
On 7.62x51 cartridges  
made in 1966.



\*B63 IRAQ  
On 7.62x39 cartridges.  
1975-1977.



B61 SUDAN  
On 7.62x51 cartridges  
made in 1980.



\*B64 IRAQ  
On 7.62x39 cartridges.  
1966 to date.  
See Note 4.



\*B62 IRAQ  
On 7.62x39 cartridges.  
1966 to date.  
See Note 4.

#### Notes to Annex B

- Note 1. May be found with any of the following Cyrillic letter year code: Г, А, Е, И, К or with two-digit numerical year codes. See section IV B, para 40a (1).
- Note 2. The Cyrillic letter И may be found on 7.62x54R cartridges with Soviet factory codes 17, 38, 46, 528, and 529 made from 1939 to 1946. For the meaning of this letter refer to section IV B, para 40a (2).
- Note 3. This headstamp is also found without the stars.
- Note 4. Variations of this headstamp may be found.
- Note 5. This headstamp is also found with stars.

ANNEX C

CARTRIDGE HEADSTAMPS CONTAINING ORIENTAL CHARACTERS  
OR MISCELLANEOUS SYMBOLS AS A MAJOR ELEMENT



C1 UNITED STATES  
Made for the Republic of  
China. 1942-1944.

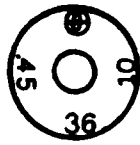

C7 REPUBLIC OF CHINA  
Mark indicates manufacture  
at Factory No. 90.  
1948-1949.  
See Note 1.

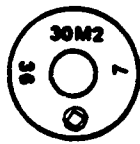

C2 REPUBLIC OF CHINA  
Mark indicates manufacture  
at Factory No. 20.  
1943-1949.  
See Note 1.

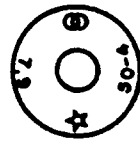

C8 CHINA  
Factory mark of former  
ROC Factory No. 10.  
1950.



C3 CHINA  
Factory mark of former  
ROC Factory No. 20.  
1950.

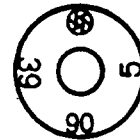

C9 TAIWAN  
Mark indicates manufacture  
at Factory No. 60.  
ca. 1951.

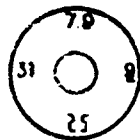

C4 REPUBLIC OF CHINA  
Mark indicates manufacture  
at Factory No. 25.  
1943-1946.

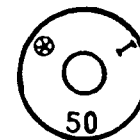

C10 CHINA  
1949-1950.

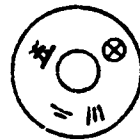

C5 REPUBLIC OF CHINA  
Mark indicates manufacture  
at Factory No. 40. 1935?  
See Note 1.

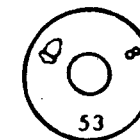

C11 CHINA  
1952-1953.

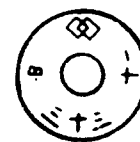

C6 REPUBLIC OF CHINA  
Mark indicates manufacture  
at Factory No. 11.  
1942-1945.  
See Note 1.

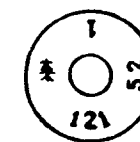

C12 CHINA  
Factory No. 121.  
1952.

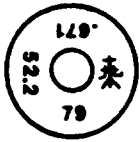

C13 CHINA  
Factory No. 671.  
1952.

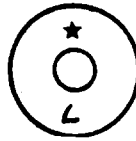

C18 NORTH KOREA  
Year unknown.



C13-1 SOUTH KOREA  
On cartridges made at  
the 1st Arsenal, 1976  
and later.

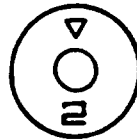

C19 NORTH KOREA  
See Note 2.



C14 NORTH KOREA  
See Note 2.

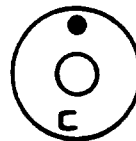

C20 NORTH KOREA  
See Note 2.

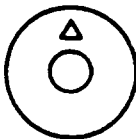

C15 NORTH KOREA  
Year unknown.

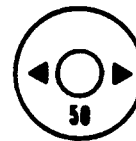

C21 NORTH KOREA  
On 7.62x39 cartridges  
made in 1950.

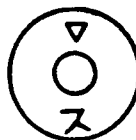

C16 NORTH KOREA  
See Note 2.



C22 JAPAN  
Mark indicates manufacture  
at Toyokawa Naval Arsenal.  
1942.  
See Note 1.

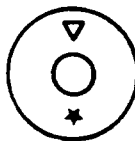

C17 NORTH KOREA  
Year unknown.



C23 JAPAN  
Mark indicates manufacture  
at Aichi Naval Plant.  
1942.

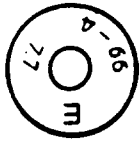

C24 JAPAN  
Mark indicates manufacture at Yokosuka Naval Arsenal. 1942.

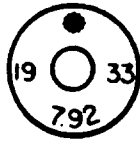

C30 UNITED KINGDOM  
On cartridges made for the Republic of China. 1933.



C25 THAILAND  
On 8x52R Type 66 cartridges, made in 1923 or later.

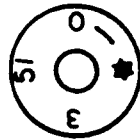

C31 CZECHOSLOVAKIA  
Also found without the curved bar. 1950-1951. See Note 3.



C26 THAILAND  
On 8x52R Type 66 cartridges, made in 1923 or later. See Note 1.

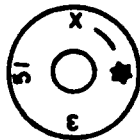

C32 CZECHOSLOVAKIA  
Also found without the curved bar. 1950-1952. See Note 3.

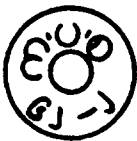

C27 BURMA  
On 7.7x56R (.303) cartridges. 1960-1962. See Note 1.



C33 CZECHOSLOVAKIA  
Also found without the curved bar. 1949-1952. See Note 3.



C28 BURMA  
On 9x19 cartridges. Year unknown.

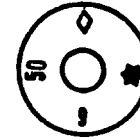

C34 CZECHOSLOVAKIA  
1949-1950.

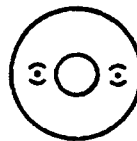

C29 JAPAN  
On blank and dummy cartridges made at Tokyo Arsenal. Also found with only one mark. 1940-1942?

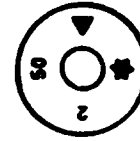

C35 CZECHOSLOVAKIA  
1949-1950.

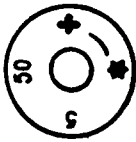

C36 CZECHOSLOVAKIA  
Also found without the  
curved bar.  
See Note 3.



C42 AUSTRIA  
Made before 1940 by  
Hirtenberg. Also found  
without segment lines.

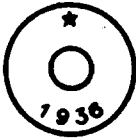

C37 AUSTRIA  
1936.



C43 AUSTRIA  
1933-1938.



C38 CHINA  
Factory No. D-53.  
1951.

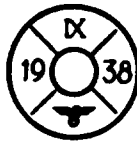

C44 AUSTRIA  
1938.

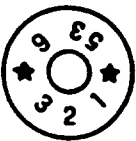

C39 CHINA  
1953?  
See Note 1.

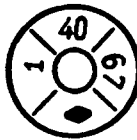

C45 POLAND  
Made under German  
occupation. 1940.

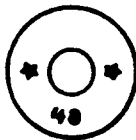

C40 NORTH KOREA  
Impressed headstamp on  
7.62x39 cartridges,  
1948-1950.



C46 LEBANON  
1956.



C41 CZECHOSLOVAKIA  
Made before 1940.  
Several calibers known.  
See Note 1.

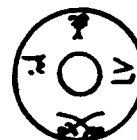

C47 SAUDI ARABIA  
1956.  
See Note 1.





C48 IRAQ  
1964.

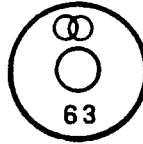

★C51 CHINA  
On 7.62x54R cartridges  
c. 1963 to date. Both  
raised and impressed  
markings are known.



C49 EGYPT  
1957-1958.  
See Headstamps B25, B27.

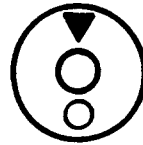

★C52 NORTH KOREA  
On 7.62x39-mm cartridge.  
Year unknown.

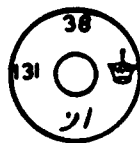

C50 IRAN  
Made in 1960.

Notes to Annex C

Note 1. Variations of this headstamp may be found.

Note 2. This triangle mark may be found with one of the following letters or characters, or, rarely, a Western two-digit year indicator:

ج, 7, ٤, C, O, H, K, O, 2, 3, 7, ٦.

Note 3. A curved bar or dash in the headstamp indicates that the Berdan primer has one flash hole rather than two. See section IV para 9a for a further explanation.

ANNEX D

CARTRIDGE HEADSTAMPS CONTAINING WESTERN NUMERALS ONLY, OR  
HAVING FACTORY CODE NUMBERS AS A MAJOR ELEMENT

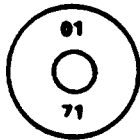

D1 GERMANY

01 is a lot number, not a factory code.

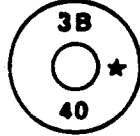

D5 SOVIET UNION

The Cyrillic letters 3B represent the factory code ZV. 1933-1941.

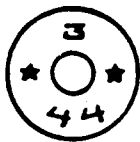

D2 SOVIET UNION

Factory code 3. 1944 to present. See Notes 1, 2, and 3.

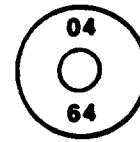

\*D6 EAST GERMANY

Factory code 04. Also found with inverted year date. 1951 to present.

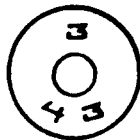

D3 SOVIET UNION

Factory code 3. 1942-1961. See Notes 1 and 4.

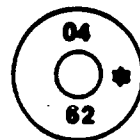

D7 EAST GERMANY

Factory code 04. A variant of the preceding mark. 1960-1962.

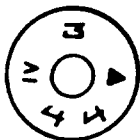

D4 SOVIET UNION

Factory code 3. 1944-1945.

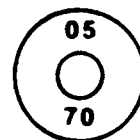

\*D8 EAST GERMANY

Factory code 05. 1962 to present. Factory code may also appear as 5.

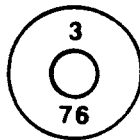

D4-1 SOVIET UNION

On assault rifle cartridges made from 1958 to date. Note difference in numeral style.

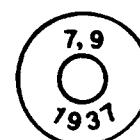

D8-1 SPAIN

On 7.92x57 cartridges made by Fábrica Nacional de Toledo in 1937.

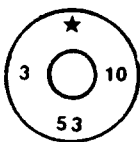

D4-2 BULGARIA

Factory code 10. On 7.62x25 cartridges made in 1953.

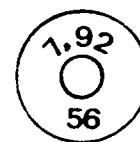

D8-2 ITALY

On 7.92x57 cartridges made in 1956 on contract for Egypt.

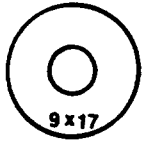

D8-3 SPAIN

On 9x17 blank cartridges made by Fábrica Nacional de Palencia. Year unknown.

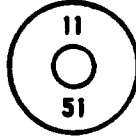

D14 YUGOSLAVIA

Factory code 11. Note serifs on numerals. 1951-1964.

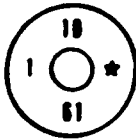

D9 BULGARIA

Factory code 10. 1961.

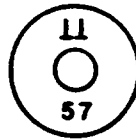

D15 CHINA

Factory code 11. Note no serifs on numerals. 1955-1957.

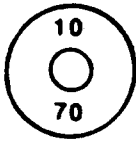

\*D10 BULGARIA

Factory code 10. 1957 to present.

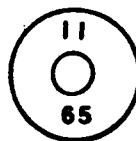

\*D16 CHINA

Factory code 11. Note no serifs on numerals. 1952-1966.

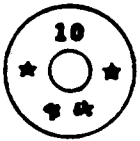

D11 SOVIET UNION

Factory code 10. 1944 is the only year known for Soviet use of this code.



D17 CHINA

Raised headstamp, on 14.5x114-mm cartridges. Numerals have serifs. 1967.

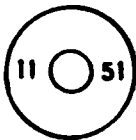

D12 YUGOSLAVIA

Factory code 11. 1951.

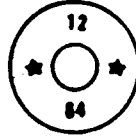

D18 YUGOSLAVIA

Factory code 12. 1949-1964.

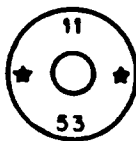

D13 YUGOSLAVIA

Factory code 11. 1948-1956.

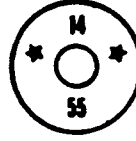

D19 YUGOSLAVIA

Factory code 14. 1955-1956.

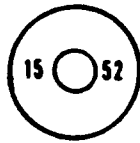

D20 UNIDENTIFIED

Factory code 15. On a 12.7x108-mm cartridge. 1952.

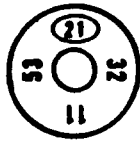

D26 POLAND

Factory code 21. 1952-1953.



D21 SOVIET UNION

Factory code 17. 1957-1958.

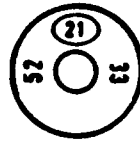

D27 POLAND

Factory code 21. 1952.

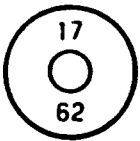

D22 SOVIET UNION

Factory code 17. 1934 to present. See Notes 1, 2, 5, and 6.

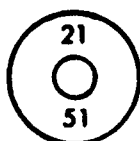

★D28 HUNGARY

Factory code 21. Note position of year date, differing from Poland's practice. 1951 to present.

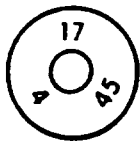

D23 SOVIET UNION

Factory code 17. 1945.

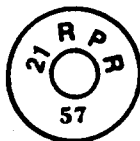

D28-1 ROMANIA

Factory code 21. On 14.5x114 cartridges. 1957-1959.

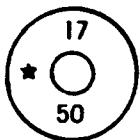

D24 SOVIET UNION

Factory code 17. 1950.

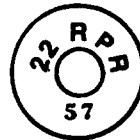

D28-2 ROMANIA

Factory code 22. On 14.5x114 cartridges. 1957.

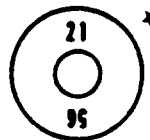

★D25 POLAND

Factory code 21. Note inverted year date, which identifies this mark as Polish. 1955 to present.

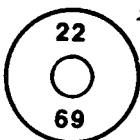

★D28-3 ROMANIA

Factory code 22. On 7.62x25 and 7.62x39 cartridges. 1951 to present.

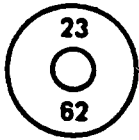

\*D29 HUNGARY  
Factory code 23.  
1961 to present.

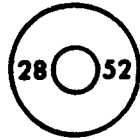

D35 UNIDENTIFIED  
Factory code 28. On a  
12.7x108-mm cartridge.  
1952.

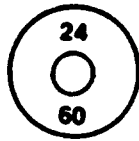

D30 UNIDENTIFIED  
Factory code 24. On a  
7.62x39-mm cartridge.  
1960.

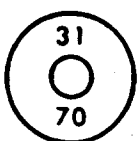

D36 CHINA  
Factory code 31.  
1956 to present.  
See Notes 8 and 9.



D31 SWEDEN  
Army producer code 24.  
1942-1957.  
See Note 7 for other  
producer codes.

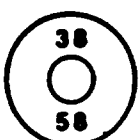

D37 SOVIET UNION  
Factory code 38.  
1939 to present.  
See Notes 1, 5, 6, and 8.

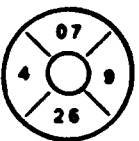

D32 SWEDEN  
Army producer code 26.  
1949.

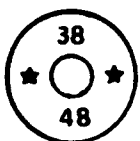

D38 SOVIET UNION  
Factory code 38.  
1948-1953.  
See Note 1.



D33 SWEDEN  
Army producer code 26.  
1959.

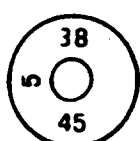

D39 SOVIET UNION  
Factory code 38.  
1945.

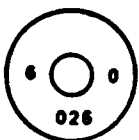

D34 SWEDEN  
Army producer code 026.  
Also found with code 027.  
1958-1966.

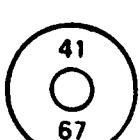

\*D40 CHINA  
Factory code 41.  
1954 to present.

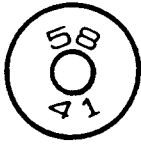

D41 CHINA  
Factory code 41.  
1958.

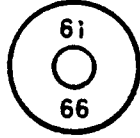

\*D47 CHINA  
Factory code 61.  
1962-1968.

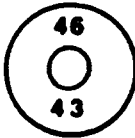

D42 SOVIET UNION  
Factory code 46.  
1943-1945.  
See Notes 2 and 5.

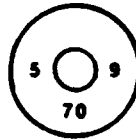

D48 SWEDEN  
Army producer code 70.  
1959.

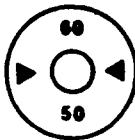

D43 SOVIET UNION  
Factory code 60.  
1950-1951.

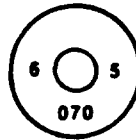

D49 SWEDEN  
Army producer code 070.  
1963-1965.

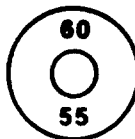

D44 SOVIET UNION  
Factory code 60.  
1930-1970.  
See Note 1.



D50 SWEDEN  
Army producer code 070.  
1965.  
See Note 7 for other  
producer codes.

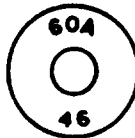

D45 TAIWAN  
Factory number 60A.  
1957.

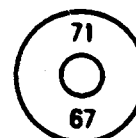

D51 CHINA  
Factory code 71.  
1956 to present.

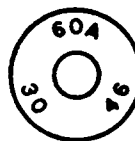

D46 TAIWAN  
A variant of the  
preceding mark. 1957.

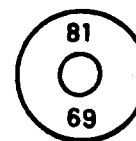

D52 CHINA  
Factory code 81.  
1956-1969.

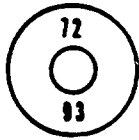

★D53 NORTH KOREA  
Factory code 93.  
1972. See also  
D85.

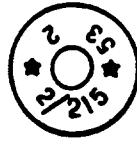

D58 CHINA  
Believed to be factory  
code 215. 1953.

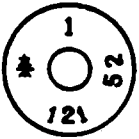

D54 CHINA  
Factory code 121.  
1952.

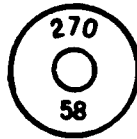

D59 SOVIET UNION  
Factory code 270.  
1951 to present.  
See Note 1.

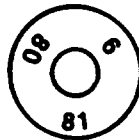

D54-1 CHINA  
Factory code 81. On  
9x18 cartridges. The  
meaning of "80" is  
unknown. Reported in  
1978.

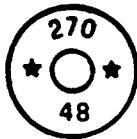

D60 SOVIET UNION  
Factory code 270.  
1946-1949.

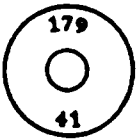

D55 SOVIET UNION  
Factory code 179; 1941  
is the only year noted.

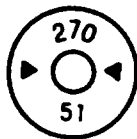

D61 SOVIET UNION  
Factory code 270.  
1950-1952.

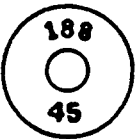

D56 SOVIET UNION  
Factory code 188. 1941  
to present.  
See Notes 1 and 2.



D62 SOVIET UNION  
Factory code 304.  
1944-1945.

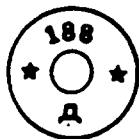

D57 SOVIET UNION  
Factory code 188.  
1953-1956.

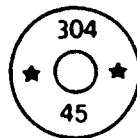

D63 SOVIET UNION  
Factory code 304.  
1944-1945.  
See Note 6.

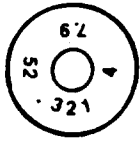

D64 CHINA  
Factory code 321.  
1952.

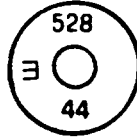

D70 SOVIET UNION  
Factory code 528. Also  
found with factory  
code 529. 1944.  
See Note 5.

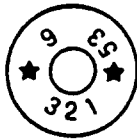

D65 CHINA  
Factory code 321.  
1953.

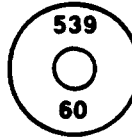

\*D71 SOVIET UNION  
Factory code 539.  
1953 to present.  
See Note 1.

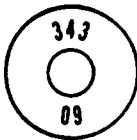

\*D66 POLAND  
Factory code 343.  
1957-1971.

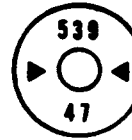

D72 SOVIET UNION  
Factory code 539.  
1947-1949.

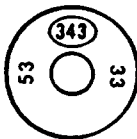

D67 POLAND  
Factory code 343.  
1953.

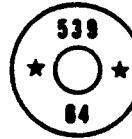

D73 SOVIET UNION  
Factory code 539.  
1953-1964.  
See Note 1.

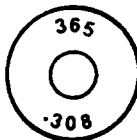

D68 UNKNOWN  
On 7.62x51-mm cartridges  
from Central Africa.  
365 may be a lot number.  
First reported in 1977.

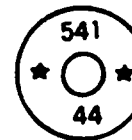

D74 SOVIET UNION  
Factory code 541. Also  
found without stars.  
1942-1945.

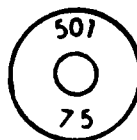

\*D69 UNKNOWN  
On 7.62x39-mm cartridges  
from Central Africa.  
501 may be a lot number.  
1972-1977.

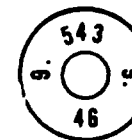

D75 SOVIET UNION  
Factory code 543. 1946.



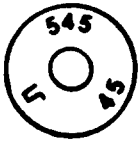

D76 SOVIET UNION  
Factory code 545.  
1945.

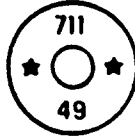

D81 SOVIET UNION  
Factory code 711.  
1948-1956.  
See Note 1.



D76-1 SWEDEN  
Army producer code 586.  
Also found without  
segment lines. Made in  
1973.

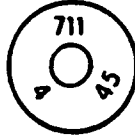

D82 SOVIET UNION  
Factory code 711.  
1945.

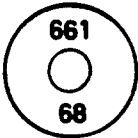

D77 CHINA  
Factory code 661.  
1968.

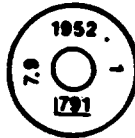

D83 CHINA  
Factory code 791.  
1952.



D78 CHINA  
Factory code 671.  
1952.

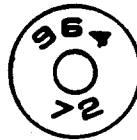

D84 UNKNOWN  
On 7.62x39-mm cartridges  
from Central Africa.  
964 may be a lot number.  
1972.

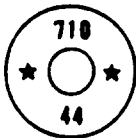

D79 SOVIET UNION  
Factory code 710.  
1944-1948.

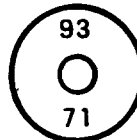

\*D85 NORTH KOREA  
Factory code 93.  
1970-1974. See also  
D53.

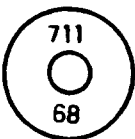

D80 SOVIET UNION  
Factory code 711.  
1944 to present.  
See Note 1.

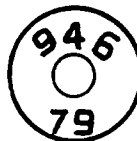

\*D86 UNKNOWN  
On 7.62x39-mm cartridge.  
1979.

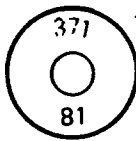

★D87 CHINA  
Factory code 371.  
On 12.7x108-mm cartridge.  
1981.

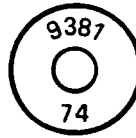

★D91 CHINA  
On 12.7x108-mm cartridges.  
Producer code 9381. 1974.

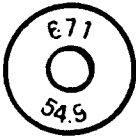

★D88 CHINA  
Factory code 671.  
On 7.62x54R cartridge.

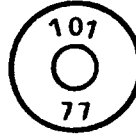

★D92 CHINA  
Factory code 101.  
On 7.62x39-mm cartridges.  
1977.

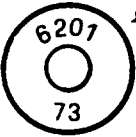

★D89 CHINA  
Factory code 6201.  
On 7.62x39-mm cartridges.  
1973.

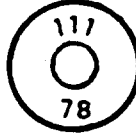

★D93 CHINA  
On 7.62x39-mm cartridges.  
Factory code 111. 1978.

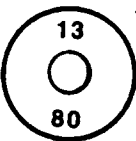

★D90 CUBA  
On 7.62x39-mm cartridges.  
Factory code 13. 1980 to  
present.

#### Notes to Annex D

- Note 1. May be found with any of the following Cyrillic-letter year codes: Г, А, Е, И, К, or with two-digit year codes. See para 40a (1) in section IV B.
- Note 2. Also found with one star.
- Note 3. Also found with one star, with a Roman numeral in the opposite quadrant.
- Note 4. Also found with a Roman numeral at 3 o'clock.
- Note 5. The Cyrillic letter И may be found on Soviet 7.62x54R cartridges with factory codes 17, 38, 46, 528, and 529. See para 40a (2) in section IV B for explanation of this letter.
- Note 6. Also found with one star, with a Western numeral in the opposite quadrant.
- Note 7. Headstamps of this type may be found with any of the following army producer codes: 24, 25, 26, 27, 28, 29, 30, 31, 32, and 70.
- Note 8. Chinese 7.62x39 cartridges have an impressed headstamp, while 7.62x54R cartridges have a raised headstamp.
- Note 9. A variation of this code may appear as 031.

APPENDIX II

OBSOLETE MILITARY CARTRIDGES

---

1. In addition to the cartridges described in section III, some other military cartridges that had become obsolete for service use before the outbreak of World War II are sufficiently well known, or were in such wide use over a period of years, that examples may still be found. The 7.62x59R (.30-40 Krag) cartridge, indeed, continued to be made until after World War II as a subcaliber practice cartridge for certain US Navy guns, while the 11.43x54R (.45-70) cartridge is still issued as a blank cartridge for Coast Guard line-throwing guns. Data on obsolete cartridges are presented in table XXXI.

2. The year date entry for the country of use indicates the year of introduction of the cartridge.

Table XXXI. Obsolete Military Cartridges

Metric caliber	Other designation	Cartridge case dimensions (in mm)					Country of use
		Length	Rim diam.	Head diam.	Mouth diam.	Bullet diam.	
11.43x51R	"Danish Remington"	51.0	14.7	13.0	12.3	11.7	*Denmark (1896)
11.45x54R	.45-70 Springfield	53.4	15.4	12.8	12.0	11.4	US (1873)
11.15x58R	"Spanish Remington"	57.8	16.0	13.9	11.7	11.2	Spain (1871)
7.62x59R	.30-40 Krag-Jorgensen	58.6	13.3	11.6	8.5	7.84	US (1892)
11x60R	11-mm Gras	59.6	17.0	13.8	11.9	11.3	France (1874)
6x60	6-mm Lee Navy; 6-mm USN	59.8	11.4	11.3	7.0	6.2	US (1895)
11.3x60R	.577/.450 Martini-Henry	59.5	19.0	17.0	12.3	11.4	UK (1871)
11.15x60R	11-mm Mauser, M71/84	60.2	15.0	13.1	11.8	11.2	Germany (1871)
11.35x62	11.35-mm Madsen	61.6	16.0	15.9	12.6	11.8	Denmark, UK (1930s)
10.15x63R	Serbian Mauser	62.5	15.0	13.2	11.0	10.4	Serbia (1878)
12.7x120R	0.5 in Vickers Type D Antiaircraft Machinegun	12.0	24.6	20.8	13.8	13.0	UK (1925)

\*Center-fire cartridge, adopted in 1896 for Model 1867 single-shot Remington rifles and carbines altered from rim-fire to center-fire ignition.

BIBLIOGRAPHY

1. White, H. P., and B. D. Munhall. Cartridge Headstamp Guide, Bel Air, Maryland, 1978.
2. Erlmeier, Hans A., and J. H. Brandt. Manual of Pistol and Revolver Cartridges. J. E. Erlmeier Press, Wiesbaden, Federal Republic of Germany, 1967.
3. Hackley, F. W., W. H. Woodin, and E. L. Scranton. History of Modern US Military Small Arms Ammunition. Macmillan, New York, 1967.
4. Pawlas, K. R. Bodenstempel-Lexikon, Vol 1-4. Nürnberg, Federal Republic of Germany, 1970.
5. Barnes, Frank C. Cartridges of the World. Follett, Chicago, 1976.
6. Datig, Fred A. Cartridges for Collectors, Vol I-III. FADCO, Beverly Hills, CA, 1975.
7. Lanza, F. Tratado de Cartucheria, Palencia, Spain, 1978.
8. Labbett, P. Military Small-Arms Ammunition of the World, 1945-1980. Arms and Armor Press, London, 1980.
9. Hogg, Ian V. The Cartridge Guide, Stackpole Books, Harrisburg, PA, 1982.
10. Hogg, Ian V. Jane's Directory of Military Small Arms Ammunition, Jane's, London, 1985.
11. Regenstreif, Philippe. Soviet and Eastern Powers Ammunition, Crepin-Leblond, Paris, 1983.