

THIS FILE IS MADE AVAILABLE THROUGH THE DECLASSIFICATION EFFORTS AND RESEARCH OF:

# THE BLACK VAULT

THE BLACK VAULT IS THE LARGEST ONLINE FREEDOM OF INFORMATION ACT / GOVERNMENT RECORD CLEARING HOUSE IN THE WORLD. THE RESEARCH EFFORTS HERE ARE RESPONSIBLE FOR THE DECLASSIFICATION OF THOUSANDS OF DOCUMENTS THROUGHOUT THE U.S. GOVERNMENT, AND ALL CAN BE DOWNLOADED BY VISITING:

[HTTP://WWW.BLACKVAULT.COM](http://www.blackvault.com)

YOU ARE ENCOURAGED TO FORWARD THIS DOCUMENT TO YOUR FRIENDS, BUT PLEASE KEEP THIS IDENTIFYING IMAGE AT THE TOP OF THE .PDF SO OTHERS CAN DOWNLOAD MORE!

# Comprehensive Report

---

of the Special Advisor to the DCI on  
Iraq's WMD

30 September 2004

volume III of III

# Iraq's Chemical Warfare Program

*By God, spare us your evil. Pick up your goods and leave. We do not need an atomic bomb. We have the dual chemical. Let them take note of this. We have the dual chemical. It exists in Iraq.<sup>1</sup>*

<sup>1</sup> Saddam speaking about the Israeli, US, and UK intelligence services and Iraq's development of binary CW munitions in a speech on 2 April 1990. (Foreign Broadcast Information Service 021329 April 1990).

*This page intentionally left blank.*

## Contents

Key Findings .....	1
Evolution of the Chemical Warfare Program .....	5
Regime Strategy and WMD Timeline .....	5
The Early Years, 1960-1980: A Slow Start.....	5
The Chemical Corps and Al-Hasan Ibn-al-Haytham Research Foundation.....	5
Full Capability, 1981-1991: Ambition.....	6
Foundation of the Al Muthanna State Establishment.....	6
Agent Production Begins and Al Muthanna State Establishment Takes Shape .....	6
Early Weaponization: Simple Solutions .....	8
CW—A Permanent and Pivotal Strategic Weapon.....	9
The Decline, 1991-1996 .....	9
Destroying Iraqi Weapons .....	9
Recovery and Transition, 1996-2003.....	12
Miscalculation, 2002-2003 .....	13
Command and Control.....	14
Preamble: Muddling Through After the Gulf War .....	14
Iraq Could Maintain CW Competence With Relative Ease.....	15
Infrastructure—Research and Development.....	16
Creation of the Iraqi Industrial Committee .....	17
The Power of the IIC .....	17
The IIC’s Master Plan for Self-Reliance: The List of 1,000 Chemicals .....	18
Dual-Use Chemicals on the List of 1,000 Chemicals.....	18
Thionyl Chloride .....	19
DCC.....	19
Thiourea .....	22
Chemicals From the List Move Toward Production.....	22
Infrastructure—Production Capability.....	23
State of Chemical Industry at OIF—Limited Break-Out Capability .....	24
Weaponization.....	29
Suspect Munitions Activities .....	29
Disposition of CW Munitions Post-1991 .....	29
The 1991 Decision To Destroy Undeclared Weapons .....	31
Iraq Unilateral Weapons Destruction in 1991 .....	31
Destruction of Chemical Munitions, Bulk Agent, and Precursors .....	31

Chemical Munitions—Searching Military Depots and Caches .....	33
Investigating Ammunition Supply Points .....	33
Investigation .....	34
Investigating Captured Enemy Ammunition Points (CEA Consolidation Points) .....	35

## **Annexes**

A. IIS Undeclared Research on Poisons and Toxins for Assassination .....	43
B. Al Muthanna Chemical Weapons Complex .....	61
C. The Iraqi Industrial Committee .....	85
D. Tariq Company’s Activities .....	89
E. Al-Abud Network .....	93
F. Detailed Preliminary Assessment of Chemical Weapons Findings .....	97
G. Chemical Warfare and the Defense of Baghdad .....	107
H. Summary of Key Findings at Captured Enemy Ammunition Consolidation Points.....	113
I. Review of 24 Iraqi Ammunition Supply Points .....	123

## Key Findings

*Saddam never abandoned his intentions to resume a CW effort when sanctions were lifted and conditions were judged favorable:*

- Saddam and many Iraqis regarded CW as a proven weapon against an enemy's superior numerical strength, a weapon that had saved the nation at least once already—during the Iran-Iraq war—and contributed to deterring the Coalition in 1991 from advancing to Baghdad.

*While a small number of old, abandoned chemical munitions have been discovered, ISG judges that Iraq unilaterally destroyed its undeclared chemical weapons stockpile in 1991.* There are no credible indications that Baghdad resumed production of chemical munitions thereafter, a policy ISG attributes to Baghdad's desire to see sanctions lifted, or rendered ineffectual, or its fear of force against it should WMD be discovered.

- The scale of the Iraqi conventional munitions stockpile, among other factors, precluded an examination of the entire stockpile; however, ISG inspected sites judged most likely associated with possible storage or deployment of chemical weapons.

*Iraq's CW program was crippled by the Gulf war and the legitimate chemical industry, which suffered under sanctions, only began to recover in the mid-1990s. Subsequent changes in the management of key military and civilian organizations, followed by an influx of funding and resources, provided Iraq with the ability to reinvigorate its industrial base.*

- Poor policies and management in the early 1990s left the Military Industrial Commission (MIC) financially unsound and in a state of almost complete disarray.
- Saddam implemented a number of changes to the Regime's organizational and programmatic structures after the departure of Husayn Kamil.
- Iraq's acceptance of the Oil-for-Food (OFF) program was the foundation of Iraq's economic recovery and sparked a flow of illicitly diverted funds that could be applied to projects for Iraq's chemical industry.

*The way Iraq organized its chemical industry after the mid-1990s allowed it to conserve the knowledge-base needed to restart a CW program, conduct a modest amount of dual-use research, and partially recover from the decline of its production capability caused by the effects of the Gulf war and UN-sponsored destruction and sanctions. Iraq implemented a rigorous and formalized system of nationwide research and production of chemicals, but ISG will not be able to resolve whether Iraq intended the system to underpin any CW-related efforts.*

- The Regime employed a cadre of trained and experienced researchers, production managers, and weaponization experts from the former CW program.
- Iraq began implementing a range of indigenous chemical production projects in 1995 and 1996. Many of these projects, while not weapons-related, were designed to improve Iraq's infrastructure, which would have enhanced Iraq's ability to produce CW agents if the scaled-up production processes were implemented.
- Iraq had an effective system for the procurement of items that Iraq was not allowed to acquire due to sanctions. ISG found no evidence that this system was used to acquire precursor chemicals in bulk; however documents indicate that dual-use laboratory equipment and chemicals were acquired through this system.

***Iraq constructed a number of new plants starting in the mid-1990s that enhanced its chemical infrastructure, although its overall industry had not fully recovered from the effects of sanctions, and had not regained pre-1991 technical sophistication or production capabilities prior to Operation Iraqi Freedom (OIF).***

- ISG did not discover chemical process or production units configured to produce key precursors or CW agents. However, site visits and debriefs revealed that Iraq maintained its ability for reconfiguring and ‘making-do’ with available equipment as substitutes for sanctioned items.
- ISG judges, based on available chemicals, infrastructure, and scientist debriefings, that Iraq at OIF probably had a capability to produce large quantities of sulfur mustard within three to six months.
- A former nerve agent expert indicated that Iraq retained the capability to produce nerve agent in significant quantities within two years, given the import of required phosphorous precursors. However, we have no credible indications that Iraq acquired or attempted to acquire large quantities of these chemicals through its existing procurement networks for sanctioned items.

In addition to new investment in its industry, Iraq was able to monitor the location and use of all existing dual-use process equipment. This provided Iraq the ability to rapidly reallocate key equipment for proscribed activities, if required by the Regime.

- One effect of UN monitoring was to implement a national level control system for important dual-use process plants.

***Iraq’s historical ability to implement simple solutions to weaponization challenges allowed Iraq to retain the capability to weaponize CW agent when the need arose. Because of the risk of discovery and consequences for ending UN sanctions, Iraq would have significantly jeopardized its chances of having sanctions lifted or no longer enforced if the UN or foreign entity had discovered that Iraq had undertaken any weaponization activities.***

- ISG has uncovered hardware at a few military depots, which suggests that Iraq may have prototyped experimental CW rounds. The available evidence is insufficient to determine the nature of the effort or the time-frame of activities.
- Iraq could indigenously produce a range of conventional munitions, throughout the 1990s, many of which had previously been adapted for filling with CW agent. However, ISG has found ambiguous evidence of weaponization activities.

***Saddam’s Leadership Defense Plan consisted of a tactical doctrine taught to all Iraqi officers and included the concept of a “red-line” or last line of defense.*** However, ISG has no information that the plan ever included a trigger for CW use.

- Despite reported high-level discussions about the use of chemical weapons in the defense of Iraq, information acquired after OIF does not confirm the inclusion of CW in Iraq’s tactical planning for OIF. We believe these were mostly theoretical discussions and do not imply the existence of undiscovered CW munitions.

***Discussions concerning WMD, particularly leading up to OIF, would have been highly compartmentalized within the Regime. ISG found no credible evidence that any field elements knew about plans for CW use during Operation Iraqi Freedom.***



- Uday—head of the Fedayeen Saddam—attempted to obtain chemical weapons for use during OIF, according to reporting, but ISG found no evidence that Iraq ever came into possession of any CW weapons.

***ISG uncovered information that the Iraqi Intelligence Service (IIS) maintained throughout 1991 to 2003 a set of undeclared covert laboratories to research and test various chemicals and poisons, primarily for intelligence operations.*** The network of laboratories could have provided an ideal, compartmented platform from which to continue CW agent R&D or small-scale production efforts, but we have no indications this was planned. (See Annex A.)

- ISG has no evidence that IIS Directorate of Criminology (M16) scientists were producing CW or BW agents in these laboratories. However, sources indicate that M16 was planning to produce several CW agents including sulfur mustard, nitrogen mustard, and Sarin.
- Exploitations of IIS laboratories, safe houses, and disposal sites revealed no evidence of CW-related research or production, however many of these sites were either sanitized by the Regime or looted prior to OIF. Interviews with key IIS officials within and outside of M16 yielded very little information about the IIS' activities in this area.
- The existence, function, and purpose of the laboratories were never declared to the UN.
- The IIS program included the use of human subjects for testing purposes.

***ISG investigated a series of key pre-OIF indicators involving the possible movement and storage of chemical weapons, focusing on 11 major depots assessed to have possible links to CW. A review of documents, interviews, available reporting, and site exploitations revealed alternate, plausible explanations for activities noted prior to OIF which, at the time, were believed to be CW-related.***

- ISG investigated pre-OIF activities at Musayyib Ammunition Storage Depot—the storage site that was judged to have the strongest link to CW. An extensive investigation of the facility revealed that there was no CW activity, unlike previously assessed.



## Evolution of the Chemical Warfare Program

Over a period of twenty years, beginning with a laboratory operated by the intelligence services, Iraq was able to begin and successfully undertake an offensive CW program which helped ensure the Regime's internal and external security. By 1984, Iraq was operating a number of CW agent production plants, producing hundreds of tons of a range of weaponized agents annually, for use against external and internal enemies of the Regime. The program was supported by a complex web of international procurement, R&D, weaponization and indigenous precursor production efforts. Iraq fired or dropped over 100,000 chemical munitions against Iranian forces and its own Kurdish population during the Iran-Iraq war and then later to help put down the Shi'a rebellion in March 1991.

- Iraq became the first nation to use a nerve agent on the battlefield when it used Tabun munitions against Iran in 1984.
- During the Iran-Iraq war, CW use helped the Iraqis turn back Iranian human-wave attacks when all other methods failed, buying time for Iraqi forces to regroup and replenish. Iraq again used CW successfully to help crush the popular revolt in 1991.
- By 1991, Iraq had amassed a sizable CW arsenal, comprising thousands of short range rockets, artillery shells, and bombs, and hundreds of tons of bulk agent. It also had produced 50 nerve agent warheads for the 650 km-range al Husayn missile.
- Despite the provisions of UN Security Council Resolution (UNSCR) 687 in April 1991, which called for Iraq to disarm, Iraq initially chose to retain CW weapons, precursors and associated equipment, making false declarations to the UN. Even when Iraq claimed to have complied with UNSCR 687 and its successors, Saddam retained components vital to restarting a CW program.

## Regime Strategy and WMD Timeline

*For an overview of Iraqi WMD programs and policy choices, readers should consult the Regime Strategy and WMD Timeline chart, enclosed as a separate foldout and in tabular form at the back of Volume I. Covering the period from 1980-2003, the timeline shows specific events bearing on the Regime's efforts in the BW, CW, delivery systems and nuclear realms and their chronological relationship with political and military developments that had direct bearing on the Regime's policy choices.*

*Readers should also be aware that, at the conclusion of each volume of text, we have also included foldout summary charts that relate inflection points—critical turning points in the Regime's WMD policymaking—to particular events/initiatives/decisions the Regime took with respect to specific WMD programs. Inflection points are marked in the margins of the body of the text with a gray triangle.*

## The Early Years, 1960-1980: A Slow Start

### The Chemical Corps and Al-Hasan Ibn-al-Haytham Research Foundation

*Iraq's interest in CW began in the early 1960s and escalated in response to a perceived threat from Iran and Israel to comprehensive CW research program by the mid-1970s.* The Regime initially sent a number of Iraqi officers abroad for training in nuclear, biological and chemical defense. These officers later formed the nucleus of the Iraqi Chemical Corps, established in 1964.

- In 1971, a cadre of Chemical Corps officers sought authorization to synthesize small quantities of CW agents (mustard, Tabun, and CS) for familiarization and the experience, according to Iraq's Currently Accurate Full and Complete Declaration (CAFCD) submitted to the UN in December 2002. The Iraqi General Staff approved the request, and laboratories were built for the Chemical Corps at al-Rashad near Baghdad.

- By 1974, this initial effort had failed, and the IIS stepped in and founded the Al Hasan Ibn al-Hai-them Research Foundation. The IIS funded Al Hasan, whose cover was as part of the Ministry of Higher Education and Scientific Research. Iraq's various intelligence services remained involved, directly and indirectly, in CW and related activities for many years.
- Al Hasan personnel were drawn from academia and the Chemical Corps. Al Hasan expanded with the construction of new laboratories in Baghdad and the selection of a new production site 60 kilometers northwest of Baghdad, later to be known as Al Muthanna. Al Hasan's mission was to research the synthesis and production of CW agents. It had limited success producing gram quantities of mustard, Tabun, CS and organophosphate pesticides like Malathion and parathion.

Iraq later declared that the work at Al Hasan was suspended in 1978 and the organization liquidated for failure to achieve its objectives, as well as for mismanagement and fraud.

- General Amer al-Sa'adi found that Al Hasan had made insufficient progress toward the goal of production. Having failed, a Presidential Decree dissolved Al Hasan.

That same year, the former head of the Chemical Corps, BG Nizar al-Atar, claims he submitted a five-year plan to the Ministry of Industry and Minerals for a CW program that included the production of weapons, and some work continued.

***By the end of 1979, a reorganized Chemical Corps used the expanded al-Rashad site to produce CW agents, ostensibly for the testing of CW defensive gear and detection equipment.*** The Chemical Corps, reinforced by many of the former Al Hasan staff, was also surveying the technical literature for information on the production of the nerve agents, Sarin and Tabun, research, which laid the groundwork for their nerve agent production processes.

## **Full Capability, 1981-1991: Ambition**

### **Foundation of the Al Muthanna State Establishment**

***Once committed, Iraq spent large amounts of money and resources on its CW program (see Figure 1).***

The outbreak of war with Iran in 1980 and Iraq's failure to attain a speedy victory appear to have been the impetus for the Ministry of Defense's launch of its industrial-scale, comprehensive, strategic CW program—code-named Research Center 922 or Project 922—on June 8, 1981. The objective was to produce CW agents—mustard, Tabun, Sarin, and VX, chemical munitions, and white phosphorus (WP) munitions. (See Annex B.)

- Project 922 covered research and development for all aspects of CW, production of CW agents and precursors, filling of CW munitions, storing of chemical munitions and agents, and acquiring sufficient technical expertise to construct and maintain production lines.
- The project also included BW R&D after 1985 and pesticide R&D from 1984 to 1987.

### **Agent Production Begins and Al Muthanna State Establishment Takes Shape**

Project 922 subsumed the Chemical Corps al-Rashad CW efforts and their site 60 km northwest of Baghdad. Within months of its inception, Project 922 began construction at the site on what was to become Iraq's main CW production and research center. West German businesses, using East German designs, supervised the creation of what was at the time the world's most modern and best-planned CW facility under the cover of pesticide production.

- Construction activity between 1982 and 1983 was intense. Iraq's foreign contractors, including Karl Kolb with Massar for reinforcement, built five large research laboratories, an administrative building, eight large underground bunkers for the storage of chemical munitions, and the first production buildings.





Figure 1. Pre-1991 CW facilities.

Chemical

Iraq had acquired sufficient expertise during the 1970s, despite fraud and failure by Al Hasan, to begin agent production immediately on completion of the first pilot-scale production line in the early 1980s. For example, 85 tons of mustard agent were produced at al-Rashad from 1981 to 1982. After Project 922 came on line, both facilities produced agent.

- 150 tons of mustard were produced in 1983.
- About 60 tons of Tabun were produced in 1984.
- Pilot-scale production of Sarin began in 1984.

Work at the Project 922 site did not pass unnoticed:

- During the summer of 1985, Iranian F-4 aircraft attacked the Samarra' site;
- This was followed in October 1986 with a SCUD attack.

As a result, Iraq moved a significant portion of its Roland Air Defense System to the Samarra' area to protect the project.

As production increased, Baghdad recognized that its dependence on foreign suppliers for precursors was a program weakness and took immediate steps towards self-reliance for precursor production. Iraq made plans to build three precursor production plants, starting in 1985, near the town of Fallujah, 50 kilometers west of Baghdad.

- Iraq began constructing Fallujah I, II and III between 1986 and 1988 to produce precursors.

***The decision to construct the precursor production plants was the beginning of a significant commitment of resources to a long-term CW program.*** In 1987, Husayn Kamil, assisted by Amer al-Sa'adi, created the MIC and renamed the CW complex *the Al Muthanna State Establishment* (MSE).

---


### ***MSE Redefines "Dual-Use"***

*The term "dual-use" refers to resources that have both WMD and legitimate civilian or conventional military applications. MSE pursued legitimate industrial projects in addition to CW agent production, particularly after the end of the Iran-Iraq war. Pesticide and pharmaceutical research took place at Al Muthanna alongside CW development, often involving the same people.*

- *The German firm Karl Kolb described the production plants it built as "general multi-purpose pilot plants," providing Iraq with plausible deniability regarding the plants and distancing Karl Kolb from being implicated in contributing to WMD programs.*
- *Pesticide research and development was a secondary responsibility for MSE. Post-1988, MSE unsuccessfully attempted to purchase a pesticide production plant from a number of leading companies worldwide, in order to expand its background knowledge in organophosphorous production.*
- *Between 1989 and 1990, during which time Iraq interrupted CW production because there was no longer an immediate need for agent, the MSE CW infrastructure produced civilian goods, including shampoos, disinfectants, and simple pesticides.*

---

### **Early Weaponization: Simple Solutions**

Against the background of the Iran-Iraq war and the pressure to halt the Iranians, Al Muthanna took every available shortcut in developing chemical weapons. To avoid the delays of developing indigenous delivery systems, Iraq purchased conventional bombs from Spain that easily could be modified for CW fill. Later, using reverse-engineering, Al Muthanna built the infrastructure to manufacture its own weapons. 


- According to Iraq's declaration to the UN in 1996, from 1981 to 1984 Iraq purchased 40,000 artillery shells, and 7,500 bomb casings from various countries that were to be modified for delivery of CW.

- Iraq also declared that by 1989, it had manufactured 10,000 CW bomb casings and 18,500 rocket warheads, all reverse engineered from imported munitions.

### **CW—A Permanent and Pivotal Strategic Weapon**

*The work underway at Al Muthanna State Enterprise by the late 1980s was an indication Saddam intended Iraq's CW effort to be a significant, large-scale program.* From its inception, MSE's Research and Development (R&D) Directorate investigated a broad assortment of agents. Iraqi CW scientists understood that they would gain the greatest battlefield impact by developing a range of CW agents with different characteristics for different situations.

- MSE's R&D Directorate had individual departments dedicated to the development of mustard agents, nerve agents, and psychomimetic compounds according to Iraq's declaration to the UN in 1996. Reporting from various sources indicates Iraq investigated more than 40 potential CW compounds.

 *Saddam believed Iraqi WMD capabilities had played a central role in the winning of the Iran-Iraq war and were vital to Iraq's national security strategy.*

- *Iraq became the first nation to use nerve agent on the battlefield when it used Tabun against Iran in 1984. By the end of the Iran-Iraq war, Iraq had used over 100,000 chemical munitions against Iranian human wave attacks and its own Kurdish population.*
- *By 1991, Iraq had amassed a sizeable CW arsenal and hundreds of tons of bulk agent. Iraq had also produced nerve agent warheads for the 650 km al-Husayn missile.*

*Reflecting those perceptions, and in a bid to create a strategic deterrent, MSE turned immediately after the Iran-Iraq war to a strategy for maintaining an offensive CW capability in peacetime.* With the end of the war in August 1988, MSE stopped CW agent production, and focused on production of marketable products while continuing research to improve production techniques, agent purity, and shelf life, although it restarted production in 1990.

- Al Muthanna's CW nerve agents contained impurities that affected agent stability and thus limited the shelf life of stored filled munitions and bulk agent. This had not mattered during the Iran-Iraq War, when Iraq was using agent as fast as it could produce it, but given Iraq's intent to use chemical weapons as a strategic deterrent, some stockpiling was essential.

*A speech by Saddam on 2 April 1990 publicly identified Iraq's CW research and production efforts in anticipation of the next war.* Saddam claimed Iraq had a binary agent capability, an assertion that caught MSE scientists off guard, according to Iraqi declaration corroborated by documents the UN discovered at Al Muthanna.

- In less than a month after Saddam's speech, Iraq restarted its CW production lines, tested CW warheads for al Husayn missiles, and reverse-engineered special parachute-retarded bombs. [According to the FFCD, Iraq did not import any aerial bombs in 1990.]

*Al Muthanna filled the al-Husayn warheads and aerial bombs with a binary nerve agent component.*

These weapons were accompanied by Jerry cans containing the second component, a chemical that, when mixed with the weapons' contents, produced nerve agent. This was the mix-before-flight Iraqi 'binary' system. Iraq deployed 1,000 binary bombs and 50 al-Husayn warheads—binary and unitary—by August 1990.

- In the subsequent first Gulf war, it is assessed that Saddam believed that the deployment of CW, and the delegated authority to use them, contributed to the US not driving on to Baghdad.

### **The Decline, 1991-1996**

#### **Destroying Iraqi Weapons**

During the Gulf war in early 1991, Coalition Forces destroyed or extensively damaged most of Iraq's CW infrastructure, including many of the agent and precursor production facilities at Al Muthanna. Then, in April 1991, the UN adopted Security Council

---

## Examples of Known Iraqi Use of CW

The war with Iran ended in August 1988. By this time, seven UN specialist missions had documented repeated use of chemicals in the war. According to Iraq, it consumed almost 19,500 chemical bombs, over 54,000 chemical artillery shells and 27,000 short-range chemical rockets between 1983 and 1988. Iraq declared it consumed about 1,800 tons of mustard gas, 140 tons of Tabun, and over 600 tons of Sarin. Almost two-thirds of the CW weapons were used in the last 18 months of the war. Examples of CW use by Iraq:

### Use in Iran-Iraq war, 1983-1988

- |  |  |
|--|--|
| • <b>August 1983 Haij Umran</b>                | Mustard , fewer than 100 Iranian/Kurdish casualties      |
| • <b>October-November 1983 Panjwin</b>         | Mustard, 3,000 Iranian/Kurdish casualties                |
| • <b>February-March 1984 Majnoon Island</b>    | Mustard, 2,500 Iranian casualties                        |
| • <b>March 1984 al-Basrah</b>                  | Tabun, 50-100 Iranian casualties                         |
| • <b>March 1985 Hawizah Marsh</b>              | Mustard & Tabun, 3,000 Iranian casualties                |
| • <b>February 1986 al-Faw</b>                  | Mustard & Tabun, 8,000 to 10,000 Iranian casualties      |
| • <b>December 1986 Um ar-Rasas</b>             | Mustard, 1,000s Iranian casualties                       |
| • <b>April 1987 al-Basrah</b>                  | Mustard & Tabun, 5,000 Iranian casualties                |
| • <b>October 1987 Sumar/Mehran</b>             | Mustard & nerve agent, 3,000 Iranian casualties          |
| • <b>March 1988 Halabjah&amp; Kurdish area</b> | Mustard & nerve agent, 1,000s Kurdish/Iranian casualties |
| • <b>April 1988 al-Faw</b>                     | Mustard & nerve agent, 1,000s Iranian casualties         |
| • <b>May 1988 Fish Lake</b>                    | Mustard & nerve agent, 100s or 1,000s Iranian casualties |
| • <b>June 1988 Majnoon Islands</b>             | Mustard & nerve agent, 100s or 1,000s Iranian casualties |
| • <b>July 1988 South-central border</b>        | Mustard & nerve agent, 100s or 1,000s Iranian casualties |

### Use in Southern Iraq against the Popular Uprising, 1991

- **March 1991, an-Najaf - Karbala area** Nerve agent & CS, Shi'a casualties not known.

These are selected uses only. Numerous other smaller scale CW attacks occurred.





Resolution 687, which established a ceasefire in the Gulf war. Iraq was required to verifiably disarm as a prerequisite to lifting of the oil embargo imposed by UNSCR 660 of August 1990.

**Iraq initially chose not to fully declare its CW weapons and infrastructure**, a decision usually attributed to Husayn Kamil and implemented by senior personnel including his senior deputy, Amer al-Sa'adi.

- Anticipating that inspections would be an ineffective and short-lived inconvenience, Iraqi leaders decided in early April 1991 to hide significant components of the CW program, including weapons, precursors, and equipment.
- Following a particularly invasive IAEA inspection in late-June 1991, Saddam ordered Dr. Mahmud Faraj Bilal, former deputy of the CW program, to destroy all hidden CW and BW materials, according to an interview with Bilal after OIF.

**Available evidence indicates Iraq destroyed its hidden CW weapons and precursors**, but key documentation and dual-use equipment were retained and were later discovered by inspectors.

*For the next five years, Iraq maintained the hidden items useful for a CW program restart but did not renew its major CW efforts out of fear the UN sanctions would not be removed. UN sanctions severely limited Iraq's financial resources. Raw materials, precursors, equipment, and expertise became increasingly scarce. The crippling of Iraq's CW infrastructure by the war, and the subsequent destruction and UN monitoring of much of the remaining materials and equipment limited Iraq's ability to rebuild or restart a CW program.*

- The effects of sanctions reverberated throughout the scientific community and affected all aspects of industry within Iraq. Many scientists were under-employed or had access to neither research and production materials nor professional development.

**In August 1995, shortly after Iraq revealed its production of bulk BW agent, Saddam's son-in-law and head of Iraq's WMD programs, Husayn Kamil, fled the country.** Saddam made a decision at that time to declare virtually all hidden information and material they felt was significant on Iraq's programs, turning over WMD documentation, including 12 trunks of CW documents.

- The documentation turned over by Iraq, allegedly hidden by Husayn Kamil, included results of Iraqi research material up to 1988 that indicated more extensive research on VX than previously admitted.
- The documents also included papers related to new agent research, mix-in-flight binary munitions development, and previously undisclosed involvement of other organizations in CW research.

*ISG believes that none of these events weakened Saddam's resolve to possess a robust CW capability. Baghdad believed its need for chemical weapons was justified, based on its fear of hostilities with Iran and Israel. The Regime, we judge, was also motivated by an unstated desire to elevate its status among Arab nations. ISG believes that Saddam deferred but did not abandon his CW ambitions.*

- *Saddam implied, according to the former Presidential Secretary, that Iraq would resume WMD programs after sanctions in order to restore the "strategic balance" within the region and, particularly, against Israel.*
- Saddam was fascinated by science and by the possibilities it offered for enhancing his military power base. He felt that possessing the technological capability to develop WMD conferred the intrinsic right on the country to do so, according to a former senior Iraqi official.
- In the 1990s, the Regime actively sought to achieve scientific excellence in Iraq through a series of administrative measures, but years of isolation from the international academic community and a lack of successful domestic research left Iraq's scientific infrastructure in decay.

- According to an Iraqi academic scientist, Saddam issued an edict in 1993-1994 that all Iraqi universities address problems encountered in the military and industrial sectors. This marked a departure from past practice where the government denied such work to universities.
- Following this order, Iraqi research universities were required to become self-funding. MIC projects accounted for much of the research funding during this time, according to a leading university scientist.
- Saddam encouraged open forums for competition among scientists through committees and other programs, and he personally awarded top scientists for exceptional work in technical fields. Saddam became personally involved in the direction of some of these programs, but many lacked unified planning or direction for research, and few were successful, according to Sa'adi.

*Following Husayn Kamil's defection, Saddam took steps to better manage Iraqi industry, and with the creation of the Iraqi Industrial Committee (IIC) in September 1995, the stage was set for a renewal of Iraq's chemical industry.* The IIC coordinated a range of projects aimed at developing an indigenous chemical production capability for strategically important chemicals that were difficult to import under UN sanctions, according to reporting. (See Annex C.)

### Recovery and Transition, 1996-2003

*Iraq's CW program was crippled by the Gulf war and the legitimate chemical industry, which suffered under sanctions, and only began to recover in the mid-1990s. Subsequent changes in the management of key military and civilian organizations, followed by an influx of funding and resources, provided Iraq with the ability to reinvigorate its industrial base.*

*Iraq's acceptance of the UN OFF program in 1996 was the foundation of Iraq's economic recovery and sparked a flow of illicitly diverted funds.*

*Iraq's chemical industry surged in the late 1990s, when more financial resources became available to the Regime. Although Iraq still lagged behind*

*its pre-Gulf war capabilities, it was able to divert a portion of its revenue to purchase new plants and renovate existing ones to renew its basic chemical industry.*

- Iraq was successful in procuring, constructing, and commissioning a complete state-of-the-art chemical facility for ammonium perchlorate through the Indian company NEC. Ammonium perchlorate is a key chemical for missile propellants.
- Iraq began refurbishing, and in some cases expanding, existing chemical facilities with foreign assistance. For example, the Al Tariq complex renovated its chlorine and phenol lines and restarted them in March 2000, according to reporting.

Between 1996 and 2003, the IIC coordinated large and important projects for the indigenous production of chemicals.

- A written order from Saddam established the National Project for Pharmaceuticals and Pesticides (NPPP). NPPP focused on the synthesis of drugs and pesticides, for which Iraq in the past relied heavily on foreign suppliers.
- The IIC examined over **1,000 chemicals for initial R&D** to determine the feasibility of scaled-up production. ISG notes that two chemicals on this list were compounds that are consistent with an experimental VX pathway.
- The process for vetting the 1,000 chemicals for economic feasibility and large-scale production was intensive and formalized. The IIC leadership built in several layers of review, research, and justification before compounds were selected for scale-up, **raising further suspicion about the three compounds, particularly dicyclocarbodiimide (DCC)—a dehydrating agent that can be used as a VX stabilizer**
- Dr. Ja'far Dhia Ja'far, and IIC member, could not recall which projects were accepted for scale-up but he knew that some compounds were dual-use and declarable to the UN, and that the National Monitoring Directorate (NMD) did not declare all of the chemicals.

**Reports of an unexplained discovery of VX traces on missile warhead fragments in April 1997 led to further tension between UNSCOM and Iraq. The uneasy relationship escalated with the discovery of the ‘Air Force Document’ (see RSI chapter) in July 1998, which indicated further Iraqi deception and obfuscation over its CW disclosures. Iraq’s anger about these two major issues was a contributing factor to Saddam’s decisions to suspend cooperation with UNSCOM and IAEA.**

- **The lack of inspectors allowed further dual-use infrastructure to be developed. The lack of effective monitoring emboldened Saddam and his illicit procurement activities.**

**Concurrently, Iraq continued to upgrade its indigenous manufacturing capability, pursuing glass-lining technology and manufacturing its own multipurpose controllers.**

- Reporting indicates that research being conducted by State Establishment for Heavy Engineering Equipment (SEHEE)—Iraq’s primary fabrication plant—beginning in 1999 was geared towards developing a process for glass lining steel reactors, making them corrosion resistant. SEHEE was focused on making cheaper, longer-lasting vessels, and reducing reliance on stainless steel.
- Documents recovered by ISG indicate that two teams, including one from the Al Majid Company had developed multipurpose controllers for typical chemical production by January 2003.

**As the chemical industry began to recover, former CW scientists remained employed, primarily at Al Tariq Company (see Annex F), on a range of issues of interest to the UN and which Iraq claimed were part of its industrial chemical or defensive NBC interests.** We have not been able to confirm that any of these efforts were connected to chemical agent production capability.

- Scientists from the former CW program formulated agent simulants such as concentrated Malathion, a pesticide, and locally manufactured a copy of a system to disperse the simulant in 2001 and 2002.

**There is an extensive, yet fragmentary and circumstantial body of evidence suggesting that Saddam pursued a strategy to maintain a capability to return to WMD production after sanctions were lifted by preserving assets and expertise.** In addition to preserved capability, we have clear evidence of his intent to resume WMD production as soon as sanctions were lifted. All sources suggest that Saddam encouraged compartmentalization and would have discussed something as sensitive as WMD with as few people as possible.

- Huwaysh claimed that in 1999 Saddam asked how long it would take to build a production line for CW agents. Huwaysh tasked four officials to investigate, and they responded that experts could readily prepare a production line for mustard within six months. VX and Sarin production were more complicated and would take longer. Huwaysh relayed this answer to Saddam, who never requested follow-up information. An Iraqi CW expert separately estimated Iraq would require only a few days to start producing mustard—if it were prepared to sacrifice the production equipment.

### **Miscalculation, 2002-2003**

**As the reality of the UN’s impending return sank in, Iraq rapidly initiated steps to prepare for inspectors. Committees and groups were formed to ensure sites and key scientists were ready to receive the inspectors.**

- As had often occurred in the past, individual scientists, heads of departments and security officials examined their plans of work for items or documents that would be subject to inspections. In every relevant location in Iraq, to some extent, normal work was disrupted in the effort to ensure Iraq was not suspected of undertaking proscribed activities.
- According to a senior chemist at the MIC, Huwaysh in October 2002, issued an order—the same order issued several times in the past—which held scientists personally responsible for any materials, equipment, or other prohibited items found by the UN.

- Vice President Taha Ramadan chaired a meeting of over 400 scientists before the inspectors returned, threatening scientists with dire consequences if the inspectors found anything that interfered with Iraq's progress towards the lifting of sanctions.
- When inspections resumed, foreign experts were hidden from the inspection teams.

*In the final days of his Regime, Saddam continued to pursue efforts to enhance Iraq's industrial base, with plans underway for the construction of a multipurpose chemical plant, and nine oil refineries in Southern and Northern Iraq. The plans for this chemical plant were the result of years of the IIC's efforts to coordinate research into the indigenous production of chemicals.*

- The Ministry of Industry and Minerals (MIM) owned a plot of land west of Baghdad that it set aside for construction of this multipurpose production facility, which was designed to produce a year's supply of 100 chemicals using only 10 independent pilot-scale production lines. (For more information, see Iraq's Infrastructure: Production Capability).
- Construction was scheduled to begin in March 2003, but was halted just prior to OIF. The plant would have provided Iraq with an indigenous multipurpose production facility capable of producing large quantities of chemicals, in a relatively short time.

## Command and Control

### Preamble: Muddling Through After the Gulf War

*ISG believes that two of Saddam's primary goals after the war were to recover economically from war damage and to retain Iraq's capability to reconstitute its WMD program after sanctions were lifted or became ineffectual, inspections were removed, and the threat of force abated.* During the Gulf war in early 1991, Coalition Forces destroyed or extensively damaged most of Iraq's CW infrastructure, including the agent and precursor production facilities at Al Muthanna. Given the Iraqi government's possession of CW data and production experience, the preservation of intellectual capital would be key to the eventual restoration of a post-sanctions CW program, and the Regime took explicit steps to ensure the preservation of its body of CW scientists.

- Many former employees of Al Muthanna were deployed to Al Tariq and worked there until OIF.
- In some cases, CW experts were diverted to companies within the IIC or the MIM, according to interviews with multiple sources after OIF. Others were assigned to be instructors at chemical schools for defensive NBC work.

*Of the approximately 200 former CW scientists—about 60 of whom are considered key CW experts from the Al Muthanna years—ISG attempted to contact close to 150 to determine their activities since 1991 and any efforts by the Regime to utilize their skills for CW-related efforts.* ISG was able to identify initial location information for approximately 130 individuals, many of whom were not able to be contacted.

- Based on locations, employment, and availability, ISG experts were able to speak to nearly 30 former key-CW scientists, none of whom claimed to have been involved in CW-related activities after 1991 or to know any individuals suspected of involvement in such work.

- With the exception of one instance, when former VX expert Imad Husayn Al-Ani was approached by ‘Uday’s officer in 2003 with a request to make chemical agent, no other scientists claimed they had been contacted by Regime officials requesting assistance in CW work.

### **Iraq Could Maintain CW Competence With Relative Ease**

The issue of retaining scientists in Iraq was a Regime policy. However, given the command economy in Iraq, which offered limited possibilities for work at private chemical companies, it is not surprising that most key personnel from the former CW program remained employed in the government chemical sector. Former CW scientists became heavily involved in rebuilding Iraq’s industrial infrastructure, and some experts were directed to work projects within various military organizations.

- Saddam instructed Directors General of Iraqi companies and other state entities to prevent key scientists from the pre-1991 WMD program from leaving the country, according to Dr. Ja’far Dhia Ja’far.

***Iraqi scientists and engineers could maintain a minimal CW production proficiency without engaging in CW-related R&D and production because they were already experienced in key CW agent production processes.*** Largely based on data available in previously published technical literature, Iraq had sufficiently developed processes to produce nerve, blister, and psychological agents.

- For instance, Iraqi research on VX started in 1985 with a literature survey on the preparation and production methods of VX. Based on their literature review, the best and easiest method was chosen for the preparation of VX agent, according to Iraq’s CW Full, Final, and Complete Disclosure (FFCD) to the UN.
- Iraq’s CW agent purity, formulation, and production standards in the 1980s program—although inferior to Western standards with the exception of its high-grade mustard—were “good enough” to produce harmful agent proven successful during previous use.

---

### ***ISG Strategy To Evaluate Whether Iraq’s Chemical Industry Infrastructure Was CW-Ready***

*ISG’s strategy for assessing the capabilities of Iraq’s chemical infrastructure to support a CW program was based on a systematic evaluation of four components necessary to maintain such a program: raw material, equipment, expertise and Regime intent. During its investigations, ISG seized documents, conducted several site visits and interviewed high-ranking technocrats, former CW scientists, and prominent Iraqi academics to determine the extent, breadth, and coordination of Regime directed dual-use infrastructure development and chemical research and production.*

- *To determine the availability of expertise required to contribute to a large-scale CW effort, ISG exploited sites, interviewed former CW scientists and analyzed documents on government-sponsored research.*
- *ISG searched for chemistry technology necessary for production of key CW precursors, such as processes involving phosphorous and chlorine.*
- *ISG used various historical intelligence reporting, open-source materials, and interviews with Iraqi scientists, and site visits to investigate Iraq’s chemical laboratories and industries, and information about Iraq’s CW agent production experts from 1991 to OIF.*
- *Chemical plants that used or produced phosphorus compounds were a priority because Iraq’s ability to quickly recover a nerve agent production capability was dependent on its access to phosphorus-based compounds.*

*Overall, ISG’s efforts to uncover information on CW-germane research, development and infrastructure were complicated by uncooperative detainees, threats to some sources and extensive looting and burning of documents and facilities.*

---

**Chemical**

*Inadequacies in Iraq's pre-1991 CW program were probably caused by limited equipment and inferior precursor chemicals. Iraq could procure the materials to address these problems if sanctions were lifted, intrusive inspections removed, and threat of force abated.*

- In the case of VX, which Iraq claimed it abandoned because of lack of success at large-scale production according to Iraq's FCCD, the scientists eventually became well aware of the factors resulting in unstable, poor quality (low purity) VX. (*see discussion on VX in production section*).
- These factors included low purity and instability of precursors, reaction temperature control, inadequate vacuum systems, and inadequate size of separation vessels.

## **Infrastructure—Research and Development**

Reflecting the importance the Regime attached to industrial and scientific progress and aiming to recover from the war with Iran, Baghdad undertook in the mid 1990s a centralized, national effort to coordinate Iraqi industrial activities. By the late 1990s, fueled by resources available through the Oil-for-Food program, that effort underlay a specific initiative aimed at boosting the capabilities of Iraqi pesticide and pharmaceutical industries, including the capability to manufacture dual-use chemicals. Although ISG found no direct evidence linking dual-use chemical production to an active or latent CW program, research and development on types of specific chemicals linked to Iraq's CW program raises concerns about the legitimacy of Iraq's chemical plans.

Prior to 1991, Iraq's national research and development (R&D) capability was limited in scope, and efforts were largely concentrated in state establishments such as the Al Muthanna State Establishment (MSE) and at the university level.

- Iraq's industrial sector had limited capabilities for research, primarily because it had typically purchased turnkey facilities for industrial production from abroad.

After the Gulf war, Iraq's ability to conduct R&D stagnated, and the majority of MSE scientists were deployed to operate factories or manage critical infrastructure problems caused by the war. The universities had no formal national R&D role and continued to operate their departments in a self-directed, isolated style.

- The effects of sanctions and the prevailing international situation devastated the research community, preventing the intellectual capital of Iraq from participating in normal academic interaction.

In the 1994 timeframe, Saddam issued an edict that all Iraqi universities address problems experienced in the military and industrial sectors, according to an Iraqi academic scientist. Prior to this, universities were not obligated to conduct applied research for either sector.

In subsequent years, and in part triggered by the surge of state funding from the OFF program, Iraq was able to begin implementing Saddam's edict and utilizing the intellectual capital of Iraq to help solve some of the shortages which had plagued Iraq's industrial and military sectors.

- An upturn in the economy after years of sanctions allowed Iraq to reevaluate its research efforts and initiate a series of projects to enhance its industrial base.

### Creation of the Iraqi Industrial Committee

***Saddam ordered the creation of the Iraqi Industrial Committee (IIC) in September 1995 to coordinate Iraqi industrial activities after Husayn Kamil fled the country according to documents.***

After the defection, Saddam assumed the role of Prime Minister as well as president of Iraq, and began attending the weekly ministers meetings. He ordered the establishment of the IIC and a similar Economic Committee to prevent the weekly meetings from becoming too detailed, according to interviews with Huwaysh.

- The RCC issued a decree formally setting up the Industrial Committee and charged it to deal with all scientific, technical, and industrial matters affecting the entire Iraqi industrial sector, according to interviews with Huwaysh and Ja'far.
- Ja'far indicated that the IIC commissioned a program aimed at developing an indigenous production capability for strategically important chemicals for domestic consumption that were difficult to import under UN sanctions

***The IIC's membership included the heads of Iraq's military and civilian industrial ministries and sectors:***

- Members included the Head of MIC, the Minister of Industry and Minerals (MIM), the Minister of Higher Education and Scientific Research (MHESR), the Minister of Oil, and the Iraqi Atomic Energy Commission (IAEC), according to multiple reports.

- Saddam appointed Minister of Oil Amer Rashid as the first IIC chairman, and he was followed by the Minister of Higher Education and Scientific Research Abd Al-Khaliq al-Ghafur in 1996 or early 1997. Abd al-Tuwab Huwaysh later assumed the role of chairman of the IIC—as well as being a Deputy Prime Minister of Iraq, according to documents signed by Huwaysh and other reporting.
- Dr. Ja'far, as the Senior Advisor to the President, was appointed as an independent member of the IIC. He was neither subordinate to a ministry nor to the IIC chairman—instead he reported directly to Saddam's personal Secretary, Abd Hamid Mahmud, according to interviews with Dr. Ja'far. Ja'far also was made chairman of the Research and Development Committee and the Technology Transfer Committee, which was later subordinated to the IIC.

### The Power of the IIC

***ISG judges that the IIC had significant influence over Iraq's chemical infrastructure, industry, and research, even though it had not been constituted with that aim in mind. In effect, the IIC was the driving force behind an extensive, centralized national infrastructure improvement effort apparently focused on developing the pesticide and pharmaceutical industries and improving self-sufficiency, based on interviews with IIC officials and documentation.***

- The IIC actively allocated research in Iraq, including work at universities, state companies and government research centers. Government ministry research resources, including the MIC's, were distributed by the IIC according to official reporting.
- The MHESR was the primary channel for recommending industrial research to universities and educational research centers in Iraq, according to the same reporting. However, the Ministry could not dictate to universities what type of research to conduct—instead, universities chose their own research based on their capabilities, according to different official reporting.

---

**Source Note: Principal source for IIC activity—Dr. Ja'far Dhia Ja'far**

*Interviews with Dr. Ja'far Dhia Ja'far provide the basis of the majority of information ISG has obtained on key IIC projects such as the National Project for Pharmaceuticals and Pesticides (NPPP) and the National Project for Active Chemical Materials, and their execution. Dr. Ja'far was founder of the Iraqi nuclear program, Director of the Office of the Presidential Advisor, and Chairman of the IIC's Research and Development and Technology Transfer Committees. A very capable technocrat, Dr. Ja'far had unparalleled access as Director and supervisor of the NPPP and Chair of IIC's Research & Development Committee, which had oversight responsibilities for chemical research. Dr. Ja'far indicated he had near total control over the implementation of the NPPP. Much of Dr. Ja'far's information has been corroborated by documents and other officials including high-ranking employees from MIC and MHESR.*

---

**The IIC's Master Plan for Self-Reliance: The List of 1,000 Chemicals**

*IIC placed greater emphasis on the synthesis of active chemical compounds than on novel R&D, because Iraq was highly dependent on foreign supplies of these materials for production of pharmaceuticals and pesticides. Several ad hoc panels drawn from the IIC's Research and Development Committee selected the final "List" of approximately 1,000 chemicals for initial R&D to assess the feasibility of scaled up production. The feasibility research was referred to as "phase 1". According to an Iraqi academic scientist, around 15 items on the List of 1,000 chemicals were so-called "first order emergency" or top priority compounds. There were also second-order emergency compounds and a third-order tier.*

The IIC distributed the final list of chemicals to Iraq's industrial Ministries, State companies, research centers, and universities, and instructed these organizations to bid on research contracts for the chemical research and development projects for which they

were best equipped to complete. IIC's Research and Development Committee identified the entities best suited for each project and awarded the contracts.

*The IIC's Program for the Indigenous Production of Chemicals appears to have evolved into a nation-wide, pan-industry, pan-academia merit-based competition for project ideas and project implementation. According to official reporting, the work stimulated by the IIC's Technology Transfer Committee, a committee involved in promoting private-sector and university research, was scientifically credible and was selected on merit. Progress on the Program for the Indigenous Production of Chemicals was largely limited to economic feasibility studies and small scale laboratory research, until approximately early 1999, according to Ja'far.*

- The Presidential Diwan reviewed and approved the final list and allocated approximately one million dinars (approximately \$US 500) per project (note—in 1998, \$1 is 2000 dinars). The IIC only planned to select a fraction of the 1,000 chemicals for scale-up after the review and recommendation process was complete.
- Studies included requirements for infrastructure, equipment, manpower, and chemical precursors, according to different reporting.

**Dual-Use Chemicals on the List of 1,000 Chemicals**

*Past Iraqi use of three of these chemicals—thionyl chloride, thiourea, and DCC—in its former VX program raises questions about their legitimacy. Thionyl chloride and thiourea were used in a VX production route that resulted in a product with higher purity for the Iraqis which we assess could have been successfully stabilized with DCC. However, we found no information linking this research to a CW program.*

- Imad Husayn al Ani, Iraq's former program director for VX, stated in an interview in 2003 that plans to produce thiourea and DCC, both of which he was unaware, indicated unequivocally that the Regime intended to reconstitute the V-series nerve agent program.



- ISG has been unable to establish why thiourea and DCC were considered strategic chemicals. There were no constraints on Iraq's importation of thiourea and no identified industrial products or processes in Iraq that require DCC for their manufacture. In addition, Mosul University had not determined the economic benefit of producing DCC.
- All three compounds were, however, part of Iraq's former VX program. Two of the compounds are directly applicable to an experimental VX synthesis route which yielded higher purities for Iraq than the two main VX production routes which it declared
- Thionyl chloride is a chlorinating agent used by Iraq in its former CW program. Iraq could have selected alternative chlorinating agents for production that are not controlled for importation or production for legitimate manufacturing purposes.

### Thionyl Chloride

*ISG does not believe that the scale-up project extended beyond feasibility studies prior to OIF, and we are unsure of Iraq's intended use thionyl chloride (SOCl<sub>2</sub>) given its many industrial uses and potential industrial value. A letter from the Office of the Presidential Advisor indicated that as of September 2002, the office had not yet received a report on pilot-scale research projects for 14 chemicals, including thionyl chloride. Thionyl chloride, a controlled CW precursor that Iraq had used as a chlorinating agent in its sulfur mustard and nerve agent production processes up until 1990, was part of the program for the indigenous production of chemicals. The IIC tasked the Jaber Bin Hayan State Company between 1996 and 1998 to research the small-scale production of thionyl chloride, according to reporting. According to official reporting, thionyl chloride production was reported to Iraq's National Monitoring Directorate.*

- After Jaber Bin Hayan in 1998 achieved its objective of reaching 99.99 percent purity on the 50 milliliter scale, the company was charged in 2001 with outlining the feasibility of pilot-scale production—approximately 1,000 kilograms—according

to official reporting and documents recovered from a MIC hard drive.

- The same former CW official believed that Jaber Bin Hayan otherwise would have been an odd choice, mainly because its facilities and equipment are ill-suited to produce thionyl chloride compared to other MIC and MIM companies. The official opined that Jaber Bin Hayan was tasked because it employed two chemists who had worked on thionyl chloride at Al Muthanna in the pre-1991 CW program.
- Reportedly, the thionyl chloride project was meant to support pharmaceutical production.

### DCC

DCC was on the UN Good's Review List, but is not restricted under the Chemical Weapons Convention Schedules of Chemicals or the Australia Group international export control Regimes, and is available on the international commercial market. ISG assessed the Iraqi domestic market for DCC was small at the time of OIF.

- Mosul University accepted the DCC tasking from the IIC in July 1998, according to a Mosul University report to the IIC sent in 2001. Other reporting discussed their research results in synthesis and purification of DCC.
- ISG discovered documents at the offices of the IIC in September 2003—which had been subjected to military action, looting, burning and deliberate destruction—outlining Iraq's intent to investigate production of DCC.
- According to a former high-ranking employee of the MHESR, the inclusion of DCC among the List of 1,000 chemicals for the IIC was common knowledge. He claimed that DCC is used in the synthesis of various compounds, and the scientists working on it would not be aware of its utility as a VX stabilizer even though it was described as a potential VX stabilizer in the Iraqi Chemical Warfare FFCD.

***Iraqis themselves differ over the economic rationale for DCC.*** DCC has several industrial uses as a dehydrating agent and acid scavenger and is used in the industrial production of peptides. A former Iraqi CW scientist familiar with legitimate lab-scale uses of DCC in the production of pharmaceuticals was not aware of a commercial reason for the use of large amounts in Iraq. However, Dr. Bilal, the former head of R&D for the CW program, stated that DCC was a dehydrating agent and thus would have applications in the pharmaceutical industry.

***DCC did not move beyond laboratory research because Iraq did not have the raw materials to produce it, according to former high ranking employees of the MIC and MHESR. However, ISG recovered documents from the Technology Transfer Office that suggest DCC was planned by Al Majid State Company for later production.***

- In late 2002, the IIC asked the MIC if they had any companies capable of producing DCC. Al Basel, Ibn Sina, al-Qa Qa'a, Al Tariq, Jaber Bin Hayan, and Al Kindi all claimed they could not produce DCC with the materials they had on hand, according to a senior chemist from the MIC.
- The Al Majid State Company was ready to transfer University of Mosul, Chemistry Department's "cyclohexanol carbon 2 Aymayid" precursor project to formal production even though no economic benefit had been determined, according to final research evaluation documents from Dr. Ja'far's office. ISG believes the "cyclohexanol carbon 2 Aymayid" is an odd notation or translation of N,N-dicyclohexylcarbodiimide (DCC).
- These documents also indicate that a precursor chemical in the DCC production process investigated by Mosul University and Baghdad University—cyclohexylamine—was researched for production.
- Of the three suspect compounds mentioned here, DCC was the only one included in the set of Process Flow Diagrams (PFDs) provided by the Al Majid State Company for potential scale-up in the multi-purpose plant. This could be an indication of Iraq's intent to produce DCC at a large scale, although we have no detailed information revealing the actual intended scale.

### ***Iraq's Declared Work With VX Nerve Agent***

***Iraq began research on VX in the 1980s but failed to declare any production or attempts to produce VX until August 1995. In its 1996 declaration, Iraq claimed to have unsuccessfully attempted large-scale VX production by two routes, and admitted researching two additional, experimental routes between 1984 and 1990.***

- *Iraq initially declared production of 0.26 tons of VX, then modified its declaration several times to reach a total of 3.9 tons produced at Al Muthanna with available pilot-scale equipment. Iraq denied large-scale VX production or weaponization.*
- *The two routes it claimed only to have researched, also known as Routes C and D, provided higher purity and yield than the two main routes, A and B. We judge that Iraq would have been more likely to continue work on one of these two routes.*
- *DCC and other dehydrating agents cannot stabilize low purity (<90%) VX for long term storage.*

***Iraq claims not to have pursued routes C and D, primarily because it did not have access to key precursors and did not retain any prior stocks that would have been necessary to produce VX.***

- *Iraq claimed to the UN that thiourea was unavailable or too expensive, but thiourea is not controlled and is available on the open market for relatively low prices.*
- *Iraq claimed to have conducted minimal research into route C, but according to UNSCOM reporting, Iraq conducted over 100 experiments on route C.*
- *Iraq had plans to procure a thiourea and nitrogen plant, both which are necessary for VX production via route C, according to UNSCOM reporting.*

***ISG during its investigation of the IIC program for strategic large-scale production noted three compounds—thionyl chloride, thiourea, and DCC—with direct applications to the Route C VX production process. The table below shows that this route, which utilizes two of the three chemicals for production, can address prior Iraqi deficiencies in VX purity and stability if yield and purity can be maintained in production scale synthesis.***

<b>Comparing routes investigated by Iraq</b>				
	<b>Route A</b>	<b>Route B</b>	<b>Route C</b>	<b>Route D</b>
Purity	60-65%	50%	80-90%	90%
Yield	50-55%	30-35%	80%	90%
Starting reactant	MPC	MPC	MPC	MPC
Couple with	choline	choline	thiocholine	chlorocholine
Source of sulfur	P2S5	P2S5	thiourea	P2S5
Binary possible?	yes	yes	yes	No
Scale of declared production	Large-scale	Large-scale	Research only	Research only
* DCC and other dehydrating agents cannot stabilize low purity (<90%) VX for long term storage.				

**Chemical**

### **Thiourea**

*Thiourea is a readily available commodity chemical not normally associated with CW agent production. It is used in the synthesis of dyes, flame retardants, pesticides and pharmaceuticals. However, thiourea was used by Iraq in successful synthesis of VX prior to the Gulf war.*

- Methyl thiouracil, a thyroid medicine which requires thiourea for its synthesis, was a project under the NPPP according to documentary reporting.

*Considering that thionyl chloride and thiourea are two of the precursors needed to synthesize VX using Iraq's investigative pathway and that DCC could potentially stabilize the product of this synthetic route, ISG believes Iraq's interest in these chemicals is suspicious. However, we note that these three compounds are a small part of the larger, more difficult organophosphorous synthesis component of VX production.*

### **Chemicals From the List Move Toward Production**

*Although ISG has multiple HUMINT and documentary reports on the Program for the Indigenous Production of Chemicals and the NPPP, we have found no evidence that any of the programs reached a commercial production phase prior to OIF. Dr. Ja'far Dhia Ja'far could not recall which projects were accepted for scale-up or the intended end-users, but he also knew some of the compounds were dual-use and declarable to the UN and that the NMD did not declare all of the chemicals.*

- The Technology Transfer Committee awarded two contracts for the preparation of Process Flow Diagrams (PFDs) for the production plant required to produce the 100 strategically important chemicals to the IAEC and to the Al Majid Chemical Engineering Center in 2002.

*Al Majid and IAEC engineers designed a plant that could produce a year's supply of each of the 100 chemicals using only 10 independent pilot-scale production lines.* The engineers supplied Ja'far with process flow diagrams (PFDs) and piping and instrumentation diagrams (P&IDs) for a plant.

- Reportedly, the conceptual designs were given to Ja'far in late 2002.
- Each production line was to be designed so that it was capable of producing multiple chemicals with only minor reconfiguration.

The multipurpose design is particularly interesting in the context of a statement made by General Faiz Abdullah Shahine—the last known director of the CW program—at a conference in 1989 or 1990 examining the future direction of Al Muthanna that “we cannot have a reactor for each unit. Even in the drug industry, they tend towards the multipurpose reactors. God willing, we will have 6 to 10 units... we must work in a manner compatible with our potentials.”

## Infrastructure—Production Capability

*Improving economic conditions and better management led to a revival in the industry's fortunes by the latter half of the 1990s. Although they still lagged behind pre-war capacity, the Regime envisioned further expansion in the new century and on the eve of OIF, Iraq had some capability to restore chemical weapons production.*

*Iraq's CW infrastructure suffered a severe blow during Desert Storm, and under subsequent UN sanctions and UN inspections. The entire industrial sector for years endured shortages of raw materials, infrastructure decay and declining production. Iraq's residual CW infrastructure was under intense scrutiny by the UN, which set up additional controls to monitor or destroy remaining materials and equipment.*

- In 1991, the majority of CW production sites suffered extensive bomb damage, but many filled munitions, bulk agent and precursors remained on site under the control of the Regime.
- Vital materials were unavailable or unaffordable, and neglected plants deteriorated while productivity declined. Electricity and water remained unreliable, which impacted on the ability to run chemical production processes.
- The UN set up the Chemical Destruction Group, which operated in Iraq from 1992-1994, tasked with the job of destroying the bulk agent, filled munitions, and precursors left over from the former program. Remaining process equipment was tagged and monitored, as was all dual-use process equipment throughout Iraq.
- By 1994, Iraq's capability to produce CW at Al Muthanna was completely destroyed, along with Iraq's supply of chemical precursors.

*An improving economy in 1997—due in part to the OFF Program—and better management at MIC led to improvement in the chemical industry, especially in production output. MIC and companies within other Ministries continued to develop, expand, and*

renovate the chemical infrastructure, and by 2001, Iraq believed it had proven its ability to defy sanctions and revive itself, according to an Iraqi economics media report.

- In 1998, the MIM began rehabilitating Al-Furat State Company for Chemical Industries' chlorine plant, employing technical teams and engineers from its own companies. According to the Iraqi economic media report, key parts for the plant that were previously imported now could be produced indigenously.
- Also in 1998, the State Enterprise for Petrochemical Industries set up a chlorine plant for water purification, according to Iraqi press reports.

*Iraq continued to upgrade its indigenous manufacturing capability, pursuing glass-lining technology and manufacturing its own multipurpose controllers.* Beginning in 1999, the Baghdad State Enterprise Heavy Engineering Equipment (SEHEE) fabrication plant initiated a research effort to develop a process for glass lining carbon steel reactors, making them corrosion resistant.

- SEHEE's research was designed to boost company profits, make cheaper, longer-lasting vessels, and reduce reliance on stainless steel. Al-Qa Qa'a State Company, at that time, requested SEHEE fabricate a 2.5 meter diameter, 2 meter tall glass-lined reactor (large-scale) for use in nitric acid production, according to reporting.
- SEHEE was successful at lining small-scale vessels, but failed in its efforts to glass-line vessels at a larger scale. An inadequate furnace probably contributed to the failure at the larger scale, according to reports from two different sources.
- Two teams from IAEC and Al Majid Company by January 2003 had developed multipurpose controllers for typical chemical production, according to documents obtained by ISG.

*Starting in 2000, production of nitric acid, plastics, chlorine, and phenol was increased.*

- Iraq's capacity to produce nitric acid tripled between 1998 and 2003.
- Plastics production increased by 125 percent in 2000, meeting production goals that were set for 2002. The Al Majid Company was also planning a new production line for PVC, according to Iraqi press reports.
- In March 2000, Iraq restarted chlorine and phenol production at the Al Tariq's Fallujah plants—also known as the Habbaniyah facilities, Iraq's key pre-1991 precursor production sites—based on reporting. (See Annex F—Al Tariq Company's Activities.)

***A steady increase in spending and improvements to the industrial sector continued throughout 2001. Additional inorganic chemical facilities were constructed and other plants were renovated.***

- Iraq built a sulfuric acid plant equipped with corrosion resistant equipment in a separate and isolated building at al-Qa Qa'a.
- MIM planned to initiate rehabilitation of Al-Furat State Company for Chemical Industries' sulfuric acid plant expecting to double its production, according to an Iraqi economics media report.
- Iraq constructed a separate nitric acid production facility at Karbala, which was completed shortly before OIF.

***Iraq's revitalization of its chemical industry continued up until OIF, and Saddam had ambitious plans for improvements well beyond 2003.*** With foreign assistance, Iraq renovated its nitric acid plant at al-Qa Qa'a, which was plagued by corrosion problems, creating a bottleneck for Iraq's munitions production.

- In 2002, Iraq made a number of improvements to the nitric acid plant at al-Qa Qa'a with equipment, materials and expertise obtained from Russia, Yugoslavia, Belarus, and Ukraine, according to Dr. Ja'far. For example, corroded compressors were replaced with new compressors, which had better, corrosion-resistant rotors.

- According to the same reporting, MIM also supervised the construction of a pilot plant for acetaminophen at the Baghdad Plant for Medical Gases. The plant was designed to produce paracetamol from nitrobenzene, but it only produced a small quantity of low quality material pre-OIF.
- According to 2003 reporting, there were plans for the construction of nine oil refineries to be built by either MIC or MIM in Southern and Northern Iraq under the control of MIC.

### **State of Chemical Industry at OIF—Limited Break-Out Capability**

---

***Definition.*** "Breakout Capability": ISG considers a CW breakout capability to be the capacity of Iraq to de novo produce and field militarily significant CW rapidly. ISG considered a range of break-out scenarios applicable to Iraq and its capabilities existing in 2002. An example of a breakout scenario would be wartime or imminent threat-precipitated production of dubious quality, low-stability agents for immediate use. A breakout capability could be deliberately developed during peacetime or improvised in response to a threat.

---

***Though on an upward trend since the late 1990s, Iraq's chemical industry was still not up to pre-Gulf war capacity as of OIF.*** Technical problems and poor maintenance of aging equipment throughout the 1990s resulted in many chemical plants, including ethylene and chlorine production plants, operating at less than half capacity despite the improvements to the chemical industry.

- A country-wide chlorine shortage, for instance, caused a lack of PVC production at the Az Zubayr plant, which was detrimental to Iraq's economy and downstream chemical processing.
- Plants within Iraq that still produced chlorine suffered from corroded condensers, and were only able to produce aqueous chlorine. Iraq, prior to OIF,

imported anhydrous chlorine gas from China, with the permission of the UN, for use within its chemical and sewage treatment industries.

- Formalene and phenol, both ostensibly produced indigenously, were imported by the resin facility north of Baghdad because of a lack of consistent, quality supply from local producers.

*ISG judges that the longstanding intent of the Regime was to restart WMD production once UN sanctions were lifted. Based on an investigation of facilities, materials, and production outputs, ISG also judges that Iraq had a break-out capability to produce large quantities of sulfur mustard CW agent, but not nerve agents.*

- Iraq declared to the UN an experimental sulfur mustard production route from locally available chemicals—sulfur, chlorine, and ethylene, all of which Iraq had access to at the time of OIF (see Figure 2).
- Iraq retained the necessary basic chemicals to produce sulfur mustard on a large-scale, but probably did not have key precursors for nerve agent production. With the importation of key phosphorus-based precursors, Iraq could have produced limited quantities of nerve agent as well.
- Mustard production could have started within days if the necessary precursor chemicals were co-located in a suitable production facility; otherwise production could have started within weeks. Nerve agent production would have taken much longer, because of the complexity of the process, according to Dr. Mahmud Faraj Bilal, a senior Iraqi scientist and CBW expert, and the lack of advanced phosphorus precursors in country. Bilal believed a covert offensive CW program was unlikely because the program would require 400-500 witting personnel.

*Iraq at OIF possessed a large range of corrosion-resistant production equipment, tagged and monitored by UNMOVIC, and procured for civilian purposes by non-CW associated facilities. However, ISG did not encounter any production units specifically configured to produce key precursors or CW agents.*

***Sulfur Mustard process and key chemicals/ associated Iraqi facilities.***

Ethylene + Chlorine (aq)	=	Chloroethanol
Chloroethanol + Na <sub>2</sub> S	=	thiodiglycol
Thiodiglycol + HCl	=	Sulfur Mustard

**Figure 2.**

---

## Phosphorus Chemistry in Iraq

**Because ISG did not find any phosphorus chemistry applicable to nerve agents at an industrial scale in Iraq, we judge that Iraq could not have produced nerve agents without imports of key phosphorus compounds.**

**Why does the indigenous production of nerve agent depend on phosphorus precursors?**

The backbone and toxicity of both G and V-series nerve agents is based on the phosphorus-carbon bond. Creating this bond utilizes trimethyl phosphite ( $(\text{CH}_3\text{O})_3\text{P}$ )—used in most phosphorus-based agents. Other phosphorus containing compounds, such as phosphoric acid and phosphates used in fertilizer production, are not suitable for forming the necessary P-C bond.

**What evidence of phosphorus did ISG find in Iraq?**

**ISG investigated four production areas suspected of conducting phosphorus chemistry:**

- **The al-Qaim Superphosphate Plant** was suspected by ISG of possible production of highly reactive phosphorus compounds. An ISG site visit revealed that by design, the plant could not be used for this purpose. At al-Qaim SPP, phosphate rock was crushed and converted into phosphoric acid. Superphosphate was then produced from the acid and sold on the local market.

- **The Al Tariq Company** was suspected of producing pesticides, a process that usually consumes similar precursors and employs similar chemical reactions as nerve agents. However, an ISG site visit and a series of interviews with Al Tariq employees revealed that the company imports concentrated pesticides (expensive and unsuitable for nerve agent production) for dilution, formulation, and resale in Iraq.

- **The Qubaysah White Phosphorus Production Facility** would have provided Iraq with the capability to convert phosphate rock into a potential nerve agent precursor. However, according to reporting the facility was never fully completed, and no equipment was installed, according to ISG analysis and a military reconnaissance mission.

- **Hutin Munitions Production and Storage Facility:** ISG discovered numerous barrels (over 3,000 gallons) of white phosphorus and munitions assembly lines, which we judge were intended for the production of white phosphorus illumination rounds. This white phosphorus, probably imported and declared by Iraq in 2002, could have been used to produce some nerve agent precursors on a laboratory scale.

- 
- Iraq also possessed declarable equipment for chemical production, which it had not declared to the UN. During ISG operation, a complete process hall containing stainless steel reaction vessels of up to  $3\text{m}^3$  for the extraction of purity of essence of plant material was discovered at Samarra' Drug Industries.

**By cannibalizing production equipment from various civilian chemical facilities, it would have been possible for Iraq to assemble a CW production plant. Alternatively, equipment that was less suitable could**

**have been reconfigured at an existing site and used for short-term limited production.** Iraq had improvised and jury-rigged equipment in the past.

- According to Dr. Bilal, Iraq's hypothetical break-out mustard production could be achieved by using equipment that could be sacrificed, instead of relying on specially lined vessels.
- In an interview, MIC director Huwaysh said that Iraq would have been willing to use systems that would be disposed of after a few production runs.



- Less corrosion resistant equipment could be used for most, if not all, CW agent chemical processes. However such equipment would wear out fairly quickly when used for some of the chemical processes involved in the agent production, according to UNMOVIC.

Figure 3 shows a two-ton bulk storage cylinder found in the underground pilot plant at Al Muthanna. The storage container had been modified in the 1980s into a reactor vessel probably for mustard production. This item escaped UNSCOM-directed destruction.

**What is “corrosion resistant” equipment?** “Corrosion resistant” is a term usually applied to equipment where all the surfaces that come into direct contact with the reagents are made of high nickel alloys, titanium alloys, tantalum alloys, ferrosilicons, ceramic or glass—all highly corrosion resistant to specific materials. Corrosion resistant equipment is commonly used in fluorinating reactions, such as Sarin and soman production, within a CW program, and for chemical processes requiring heat and chlorinating agents such as the manufacture of mustard and nerve agents. Most commercially available materials used in the manufacture of chemical production equipment have some degree of corrosion resistance.

---

### **Chemical Process Development and Engineering in Iraq**

*ISG examined a range of documents obtained for Iraq’s key engineering design center which show that Iraqi chemical manufacturers followed process development engineering practices that are very similar to international convention. This is not surprising given the legacy of British oil production and refining in Iraq.*

*The plant designs and process plans of MIC and MIC subcontractors essentially conformed to the international norm, based on analysis of seized documents. MIC projects for “Triethylamine Process Scale-up”, “Xylidene Production Plans” and a fuming sulfuric acid (oleum) plant all demonstrated Iraqi engineering capability.*

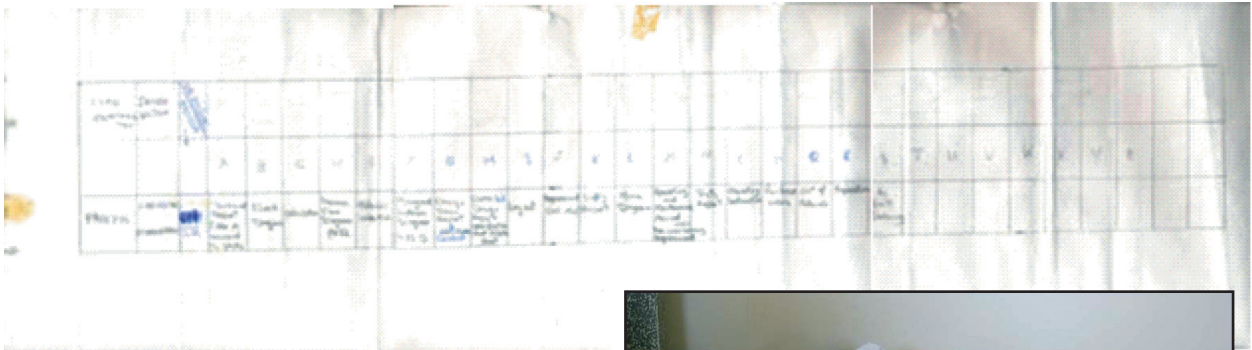
- *MIC used AutoCAD software for many of its designs. Process modeling and some PFD’s appear to have been produced using ChemCAD software.*
- *A chart taken from the Sa’ad Center (see Figure 4) outlines the planning and building of a proposed oleum plant. Although it handwritten, it is the same engineering strategy used by most global corporations.*
- *The IIC and the MIC often tasked universities to prepare these initial technical reports, feasibility studies and drawings, steps A-C, as seen with the List of 1,000 Chemicals. The work Mosul University did in its report “Preparation of N,N-Dicyclohexyl Carbodiimide” is an example of a typical early-end feasibility study.*

*Figure 4 illustrates a portion of the total design package (Items A-S) for the oleum plant. These drawings and plans are not merely academic steps to optimize a given process. In many multi-step chemical manufacturing processes, minimal and safe operational performance would require most of these development steps, even for small scale facilities that have the capability to switch between products rapidly.*

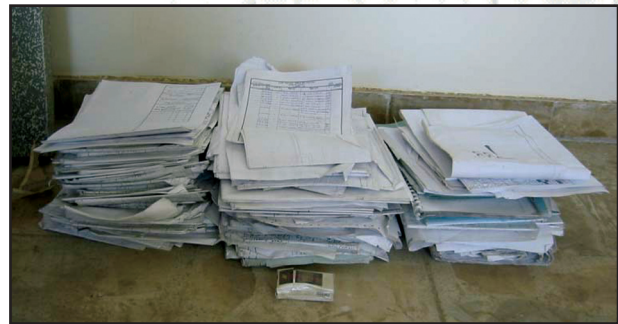
---



**Figure 3.** A two ton bulk storage cylinder found in the underground pilot plant at Al Muthanna. The storage container had been modified in the 1980s into a reactor vessel probably for mustard production. This item escaped UNSCOM-directed destruction.



**Figure 4.** This chart illustrates a portion of the total design package (Items A-S) for the oleum plant. These drawings and plans are not merely academic steps to optimized a given process. In many multi-step chemical manufacturing processes, minimal and safe operational performance would require most of these development steps, even for small scale facilities that have the capability to switch between products rapidly.



## Weaponization

*Iraq's capability to produce CW munitions on a large scale ended with Desert Storm. However, Iraq retained the ability to retool existing factories to produce new munitions, and would have relied on basic fabrication techniques to weaponize agent if it had chosen to do so.*

- Most of the Iraqi modifications for chemical delivery consisted of simple machining and/or welding of aluminum or steel.
- Although much of the Iraqi infrastructure to fill CW munitions was destroyed, the technology was basic and we judged it could be quickly recreated.
- The performance of the modified weapons was usually sub-optimal by Western standards, reflecting the simplicity—or crudeness—of Iraqi design approaches. However, the performance was usually good enough to meet minimum requirements.

## Suspect Munitions Activities

A number of unusual and unexplained items found at Taji ammo depot could have been used for either conventional or CW weaponization. All Iraqi CW weaponization experts who were asked by ISG were unfamiliar with these items, and although they could have been intended for CW delivery, the items represented crude prototypes and concept components that were found at a non-Al Muthanna bunker.

- In January 2003, UNMOVIC found several suspect items at the Taji ammunition depot, including six unfilled CW 122mm rocket warheads and munitions base plates of varying sizes.
- A number of scientists who were involved with Iraq's CW weaponization projects did not recognize the 76mm, 115mm and 183mm base plates, shown to them in photographs. They speculated that these base plates could have been used for CW munitions.

- A former Iraqi CW munitions researcher offered a dissenting opinion by claiming the thread type on the base plates would not be sufficient to keep the munitions from leaking. Furthermore he claimed that the 183mm base plate found could not have been for a chemical munitions because Iraq did not work on munitions this large.
- No other significant munitions components of these sizes have been found to date. ISG therefore is unable to satisfactorily to conclude the munitions type and caliber.

*In September 2003, a senior official at the Al Nu'man cluster bomb production facility gave ISG a 3.5-liter CW submunitions he claimed had been held by a factory worker in his private residence to keep it from being looted. The Al Nu'man facility historically had been involved in attempts to develop chemical capable submunitions, which had been a focus of Iraqi pre-Desert Storm munitions development work.*

## Disposition of CW Munitions Post-1991

*ISG expended considerable time and effort investigating longstanding Iraqi assertions about the fate of CW munitions known to have been in Baghdad's possession during the Gulf war. We believe the vast majority of these munitions were destroyed, but questions remain concerning hundreds of CW munitions.*

Since May 2004, ISG has recovered dozens of additional chemical munitions, including artillery rounds, rockets and a binary Sarin artillery projectile (see Figure 5). In each case, the recovered munitions appear to have been part of the pre-1991 Gulf war stocks, but we can neither determine if the munitions were declared to the UN or if, as required by the UN SCR 687, Iraq attempted to destroy them. (See Annex F.)

- The most significant recovered munitions was a 152mm binary Sarin artillery projectile which insurgents had attempted to use as an improvised explosive device.



**Figure 5. Chemical weapons findings in Iraq.**

---

### ***Post-OIF Insurgent Attempts to Tap Chemical Resources***

*A group of insurgents began a nascent CW effort without CW scientists or industrial-scale chemical supplies. After OIF, a group of insurgents—referred to as the al-Abud network—assembled key supplies and relevant expertise from community resources to develop a program for weaponizing CW agents for use against Coalition Forces. The al-Abud network in late 2003 recruited a Baghdad chemist—who lacked the relevant CW expertise—to develop chemical agents. The group sought and easily acquired from farmers and local shops chemicals and equipment to conduct CW experiments. An investigation of these CW attempts suggests that the al-Abud network failed to produce desired CW agents, however it remains unclear whether these failures derive from a lack of available precursors or insufficient CW expertise.*

---

- ISG has also recovered 155mm chemical rounds and 122mm artillery rockets which we judge came from abandoned Regime stocks.

### **The 1991 Decision To Destroy Undeclared Weapons**

***An IAEA inspection led by Dr. David Kay in late June 1991 triggered Iraq’s decision to unilaterally destroy the undeclared weapons that had been concealed from the UN, according to multiple senior Iraqi officials.*** Dr. Kay’s inspection team was blocked from sites in Abu Ghurayb and Fallujah. The Iraqis fired warning shots over the inspectors’ heads, but Dr. Kay and his group brought back video tapes and photos that indicated Iraq was hiding undeclared uranium enrichment equipment from the inspectors.

- Dr. Kay’s inspection and the international uproar surrounding it caused consternation and a measure of panic in the Regime’s leadership, particularly Husayn Kamil, and Saddam appointed a high-level committee headed by Deputy Prime Minister Tariq ‘Aziz to deal with inspection matters, according to multiple sources.
- A senior Iraqi scientist who directed the destruction of chemical and biological munitions contends that the decision to destroy the hidden materials was

made at the end of June 1991. David Kay’s inspection and the ensuing controversy prompted Iraqi concerns about renewed war with the United States, according to Dr. Mahmud Firaj Bilal. Amir Rashid contacted Dr. Bilal and ordered that all hidden chemical and biological munitions be destroyed within 48 hours. When Bilal responded that this was impossible, Rashid directed that Bilal use the resources of the Iraqi Air Force and the surface-to-surface missile force to accomplish the task. Dr. Bilal gathered his colleagues from Al Muthanna State Establishment, went to the locations of the stored munitions, and began the destruction.

- Iraq declared some of the unilateral destruction—missiles and chemical munitions—to UNSCOM in March 1992 but continued to conceal the destruction of the biological weapons program.

### **Iraq Unilateral Weapons Destruction in 1991**

Iraq completed the destruction of its pre-1991 stockpile of CW by the end of 1991, with most items destroyed in July of that year. ISG judges that Iraq destroyed almost all prohibited weapons at that time.

- ISG has obtained no evidence that contradicts our assessment that the Iraqis destroyed most of their hidden stockpile, although we recovered a small number of pre-1991 chemical munitions in early to mid 2004.
- These remaining pre-1991 weapons either escaped destruction in 1991 or suffered only partial damage. More may be found in the months and years ahead.

### **Destruction of Chemical Munitions, Bulk Agent, and Precursors**

ISG interviewed Dr. Mahmud Firaj Bilal, the Iraqi scientist who supervised the destruction of Iraq’s undeclared chemical munitions, along with a number of Iraqi higher officials who were knowledgeable of the weapons destruction. Although other sources have corroborated parts of Dr. Bilal’s account, ISG’s understanding of Iraq’s chemical and biological warfare agent unilateral destruction is heavily dependent

on Dr. Bilal's information, which is a weakness in our analysis. Nevertheless, as with Iraq's long range missiles, we obtained a reasonably coherent account of the disposition of the CW munitions, though we were not able physically to verify the story. The UN has, however, verified some of it.

- Iraq likely destroyed all 20 concealed CW Al Husayn missile warheads in the summer of 1991, according to Dr. Bilal based on UN-sponsored excavations. All were "binary" GB/GF nerve agent warheads filled with a mixture of isopropanol and cyclohexanol and MPF.
- Al Muthanna had dispersed approximately 1024 CW R-400 bombs along various Iraqi airbases. Iraq did not declare some of these to the UN and unilaterally destroyed them in situ. The UN holds these as accounted for, although they were unaware that a small percentage of them were used on the Shia in March 1991 according to multiple sources.
- Iraq disposed of 1.5 tons of spoiled bulk VX nerve agent at the Al Muthanna State Establishment dumpsite.
- Dr. Bilal also stated that Iraq destroyed the following chemical agent precursors:

*—157 tons of the VX precursor phosphorus pentasulfide (P2S5) destroyed by mixing it with soil at Saqlawiyah, northwest of Fallujah. UNSCOM-sponsored excavations accounted for about this amount.*

*—55 tons of the VX precursor choline destroyed at Qasr al-'ashiq near Samarra'.*

*—10 tons of the mustard precursor thiodiglycol destroyed by burning at Saqlawiyah. This precursor was never declared to the UN and had been stored in the city of Samarra'. When the rest of the unilateral destruction took place, no one remembered this stock until a month after the rest of the chemical destruction. This realization triggered its destruction.*

*—Al Muthanna State Establishment gave cyclohexanol, isopropanol, and isopropylamine to various industries for use as solvents.*

- Iraq also destroyed a quantity of empty aerial bombs intended for CW use and empty 122-mm CW rockets.
- Bilal insisted that Iraq's CW "Full, Final, and Complete Declaration" is completely accurate regarding the unilateral destruction of CW munitions.

***UNSCOM had verified or accepted some of what Bilal said about munitions destruction, but other parts of the story remain unverified.***

- Iraq presented supporting documents on the unilateral destruction of 527 R-400 CW bombs and UNSCOM observed remnants of bombs consistent with the declared quantity.
- When considered with the number of declared BW Al Husayn warheads (25), the total number of undeclared "special warheads" was 45. In the period from 1992 to 1998, UNSCOM recovered and accounted for remnants of 43-45 special warheads. In 1997-1998, UNSCOM recovered the remnants of three additional training warheads. Iraq provided supporting documents on the overall accounting for special warheads and on the unilateral destruction of 45 warheads. We cannot be sure, however, that there were only 45 "special" warheads in Iraq's inventory.
- UNSCOM was not able to verify the quantity of VX destroyed, nor were they able to verify the destruction of all VX precursor chemicals.
- UNSCOM was not able to verify the destruction of unfilled 250 gauge aerial bombs, unfilled R-400 aerial bombs, and unfilled 122-mm rockets.

The destruction years ago of the bulk of Iraq's CW munitions notwithstanding, ISG remains concerned about the status and whereabouts of hundreds of CW artillery rounds. Previous assertions that the munitions were all destroyed have been undermined by reporting that the munitions remain intact in an unknown location.

***In the 5 January 1999 Compendium, UNSCOM assessed that Iraq had not adequately accounted for 550 mustard-filled artillery rounds it claimed to have lost.*** This issue first surfaced in 1996 because of discrepancies in Iraq's accounting of weapons holdings,

---

## VX Weaponization

---

*Iraq had not adequately addressed VX production and weaponization activities—a point on which Iraq’s denials were contradicted by UNSCOM findings. ISG investigations into Iraq’s work with VX reveals that Iraq did weaponize VX in 1988, and dropped 3 aerial bombs filled with VX on Iran. The bombs, originally declared to be part of a storage stability trial, were in fact dropped on an undisclosed Iranian location in 1988.*

---

and was investigated but not resolved by UNSCOM (see the January 1999 UN compendium for details). ISG conducted extensive interviews with high- and mid-level Iraqi officials to determine the final disposition of the 550 mustard-filled rounds—which would be highly toxic, even now—cited by the UN as an unresolved disarmament issue, and found inconsistencies in the story among witting high-level officials. Most officials recounted the story of accidental destruction in a fire in Karbala, reporting provided to the UN after Iraq’s investigation of this issue prior to 1998, while the former MIC director, Huwaysh, claims the rounds were retained for future use.

- In a 7 August 2003 debriefing, Huwaysh said that as of early 2003, all 550 mustard rounds were kept by the SRG at Suwayrah, probably the former location of the II RG Corps Headquarters, just north of the Shaykh-Mazar ammunition depot.
- According to Huwaysh, the matter was discussed by the Higher Committee on Monitoring Inspections and a decision was made to declare the shells, which was done just prior to OIF.
- Amir Rashid admitted that the Higher Committee discussed the shells in February or March 2003. Rashid said the discussion focused on the connection between the burned mustard shells at the Fallujah proving ground and other shells that reportedly burned on a trailer near Karbala after the 1991 Gulf War.
- General Hussam Amin did not remember any discussions of Suwayrah and mustard shells. According to Amin, in early 2003, General ‘Amir Al Sa’adi explained to him that the mustard shells were destroyed on the trailer near Karbala.

## Chemical Munitions—Searching Military Depots and Caches

*Reflecting pre-OIF intelligence assessments that Iraq had stockpiled hundreds of tons of chemical weapons, ISG expended considerable time and expertise searching for extant CW munitions.* ISG inspected ammunition supply points identified from preliminary analysis of the ‘red-line’ theory—including sites in proximity to units possibly equipped with chemical-capable weapons and in proximity to suspected decontamination activity.

- ISG exploited munitions at captured enemy ammunition (CEA) depots established by Coalition Forces after OIF to serve as repositories for ammunition captured throughout the country.
- Teams also investigated other suspect locations identified prior to OIF as suspect CW locations, in particular 11 depots at which possible CW movement and storage activity was assessed to have taken place in the late 2002-2003 time-frame.
- Overall, only a modest fraction of rounds were identified for exploitation. The sites had been subject to looting during and after OIF, bombing of military installations during the war, and detonation of large numbers of rounds by Coalition Forces.
- Although only a fraction of Iraq’s total munitions inventory was identified and exploited for CW rounds, a review of high-priority facilities, munitions caches, and locations identified prior to OIF as suspect CW storage or transfer sites, did not reveal caches of CW weapons.

### Investigating Ammunition Supply Points

*ISG’s investigation of Iraq’s ammunition supply points—ammunition depots, field ammunition supply points (FASPs), tactical FASPs, and other dispersed weapons caches—has not uncovered any*

---

### **Types of ASPs**

*ASPs can be divided into three different classes: (1) Ammunition Depot, (2) Field Ammunition Supply Point (FASP), and (3) Tactical FASP (TFASP). Sites vary depending on permanence of structures and proximity to forward deployed units.*

- *Ammunition Depots are permanent structures located far from the forward lines. They are fenced and guarded with hardened bunkers as well as revetments for open storage. Depots are designed to supply munitions to a large number of different units and as a result contain a wide variety of ammunition types.*
  - *FASPs are usually permanent structures as well. As with depots, they are usually fenced and guarded and may contain bunkers or revetments. FASPs are meant to serve a smaller number of units and will maintain a limited mixture of munitions. In US Army terminology, they would be equivalent to Ammunition Transfer Points, or ATPs.*
  - *TFASPs are semi-permanent structures in close proximity to the units that require the munitions. They may be fenced or bermed and contain mostly open storage in revetments. TFASPs function as the immediate supply point for a limited number of units and retain only the munitions required for those units. In US Army terminology, a TFASP would be equivalent to a cache.*
- 

**CW munitions.** ISG investigation, however, was hampered by several factors beyond our control. The scale and complexity of Iraqi munitions handling, storage, and weapons markings, and extensive looting and destruction at military facilities during OIF significantly limited the number of munitions that ISG was able to thoroughly inspect.

- ISG technical experts fully evaluated less than one quarter of one percent of the over 10,000 weapons caches throughout Iraq, and visited fewer than ten ammunition depots identified prior to OIF as suspect CW sites.

- The enormous number of munitions dispersed throughout the country may include some older, CW-filled munitions, and ISG cannot discount the possibility that a few large caches of munitions remain to be discovered within Iraq.

### **Investigation**

***ISG began its search for Iraqi chemical weapons by identifying a set of facilities from the nearly 1,000 sites at which Iraq stockpiled or deployed munitions.*** ISG obtained from CENTCOM a database of 104 ASPs identified within the assessed “Red Line” surrounding Baghdad (*see Annex G, for details on the ‘Red Line Theory’*). This list was narrowed down to 26 sites using two main criteria (see Figure 6).

- Reporting of a suspect CW decontamination vehicle, a “Samarra” type water truck in proximity to the ASP—at the time the targets were selected, the presence of these vehicles was regarded as indicators of CW-related activity.
- An artillery unit capable of firing 122mm multiple-rocket launcher (MRL) or 155mm CW rounds, also in proximity of the site.

The ASPs of the Republican Guard Al Madinah, Al Manawrah, Baghdad, and Hammurabi Divisions were of highest priority because of the units’ trusted status and location during the combat phase of OIF. Exploitation of the 26 ASPs began with a thorough review of all reporting the facilities to discern the status and change in the site during and after OIF, in order to narrow the list of sites to be visited.

- Reporting revealed 16 of the 26 sites were either empty, destroyed, or contained unidentified material with an imagery signature inconsistent with CW. One site was found to be a duplicate location under a different name and another was removed for lack of evidence. Teams from ISG visited the remaining eight sites.



- ISG investigation of eight ASPs turned up a wealth of different Iraqi munitions including artillery shells, and rockets. However, we did not locate any CW filled artillery.

### Investigating Captured Enemy Ammunition Points (CEA Consolidation Points)

*ISG capitalized on efforts by Coalition Forces in December 2003 to begin a program to consolidate captured Iraqi weapons into seven pre-identified Captured Enemy Ammunition (CEA) Depots (see Figure 7).* As of mid-September 2004, Coalition Forces have reviewed and cleared a total of 10,033 weapons caches dispersed throughout the country, destroying a total of 243,045 tons of munitions. This represents only part of Iraq's pre-OIF munitions inventory, and only a fraction of these were checked by ISG technical experts for signs of chemical agent fill. (See Annex H.)

Many of the rounds were destroyed at their original cache locations or at a CEA depot; however, ISG technical experts have been working with CEA officials to evaluate munitions that were returned to consolidation points for storage or later destruction.

- ISG reviewed CEA inventory lists for chemical-capable projectiles, rockets, missiles, or bombs, and conducted missions to the consolidation points to X-ray, catalogue, and analyze specific rounds for CW signatures. No CW munitions were found at these sites as of September 2004.
- ISG teams also sought unique munitions identified by CEA as new shipments arrived onsite. No significant findings were reported.

*ISG estimates that CEA visits allowed us to review at most about 10 percent of Iraqi munitions.* As of 15 September 2004, *CEA has identified a total of 10,049 caches* (a cache is considered a collection of munitions in any quantity) throughout Iraq. The breakdown of their activities follows:

- To date, 10,033 caches have been cleared with a total of 405,944 tons of munitions delivered to the CEA points, an average of about 40 tons of munitions per cleared cache. Of that total, **243,045 tons of munitions have been destroyed**, and 162,899 tons remain at the CEA points for future destruction.

- 16 caches remain outstanding, containing an estimated total of 6,068 tons, an average of 380 tons per cache.

- ISG conducted CEA visits at about a two-per-month rate in early 2004 and it is estimated that ISG experts reviewed about 50,000-75,000 tons of munitions—about 12 to 18 percent of the grand total of 412,012 existing tons.

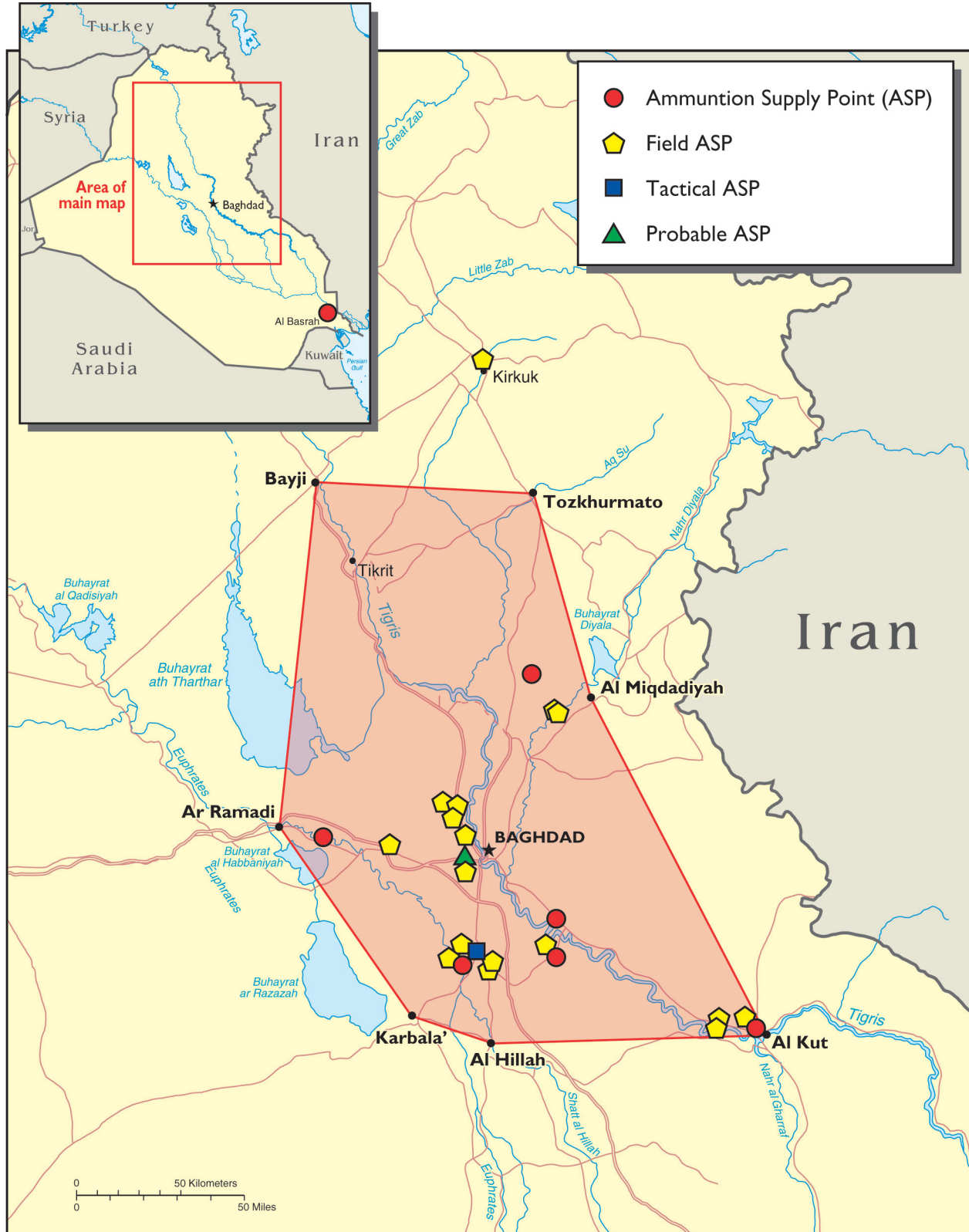
- In addition to the CEA process, a large number of munitions were destroyed between OIF and late 2003, when CEA instituted its process. Officials at CEA have been highly efficient in destroying as much as 25,000 tons of munitions per month.

- Recent data indicate that the grand total will continue to grow. Over the six-week period from the end of July to mid-September, CEA discovered an additional 291 caches with a total of 105,028 tons of munitions—cache discoveries continued to the time of writing. CEA estimates a total of 600,000 tons of munitions is the total tonnage, including munitions destroyed during OIF and scattered about the countryside. ISG believes this number is fairly uncertain, and could go considerably higher in the future as new caches are discovered. We regard 600,000 as a lower limit on total munitions. Using this number, we estimate we visited about 8-12 percent (in round numbers, 10 percent), or less of the total Iraqi munitions stocks.

Although ISG only inspected a small fraction of the Iraqi munitions, we remain confident that we have not destroyed chemical munitions in the process of destroying Iraqi weapons.

- The US military has high confidence that the destruction process has thus far proceeded safely, with no release of chemicals connected with it.

Figure 6. Location of 26 RG ASPs. The "Red Line" is shown for reference purposes.



- The amount of inspections ISG was able to carry out was consistent with the resources available, and the safety factors involved in carrying out the inspections of munitions facilities.

*In addition to the ASPs and CEA sites, ISG undertook a systematic effort to review and investigate a series of depots that factored prominently in pre-OIF assessments of possible CW transshipment activity in the 2002-2003 timeframe.* Several studies, based primarily on imagery Analysis at that time concluded that Iraq probably deployed CW munitions from depots to ammunition supply points throughout Iraq as part of ongoing preparations for war. The original list of 11 sites at which activity had been noted was narrowed to two main depots for intensive ISG investigation, including site visits, technical assessments, and personal interviews.

- Imagery analysis observed indication of ammunition movement Iraq in 2002. Analysis of specific activity—at the 11 depots—raised increased analytic scrutiny and prompted a review of munitions transshipment signatures throughout Iraq.
- The key indicators to identify suspect CW munitions movement and storage included the presence of special guards, vehicles assessed to be decontamination trucks, cargo vehicles, and the grading of top soil near suspect bunkers.

*ISG began an investigation of the 11 major depots by reviewing imagery reporting of the sites to determine feasibility for site exploitations and by*

*subsequent site visits and identification of individuals and military officials who had previously worked there.* ISG analysis revealed that most of the sites were destroyed or looted during or shortly after OIF, and the military officers who worked there proved difficult to locate.

- ISG conducted an in-depth investigation of the **Al-Musayyib Storage Depot**—assessed prior to OIF to have the strongest indicators of CW movement—in an attempt to understand the nature of suspect CW transshipment activity there between 1998 and 2002. (See Annex H for a detailed account).
- Reporting indicated the presence of a suspect CW decontamination vehicle at the **Miqdadiyah Depot** north of Baghdad and prompted an ISG operation to recover two vehicles for exploitation.
- The remaining sites were not visited because indicated looting and destruction that prevented the discovery of any munitions remaining from pre-OIF.



**Figure 7.** Captured enemy ammunition supply points.



Chemical

**Figure 7.** Captured enemy ammunition supply points (continued).

	Depot Name	Pre-OIF "Indicators"	ISG Investigations
1	Al Miqdadiyah Ammunition Storage Facility	<ul style="list-style-type: none"> <li>-Presence of Samarra'-type vehicle</li> <li>-Separately secured area under MEK control</li> <li>-Transshipment with stakebed trucks and Samarra'-type vehicle 1994</li> <li>-Transshipment with stakebed trucks and Samarra'-type vehicle in Jan 2003</li> <li>-Visited by UNMOVIC after 2003 transshipment activity terminated</li> </ul>	<ul style="list-style-type: none"> <li>-Identification and acquisition of two 'Samarra'-type' vehicles from the Miqdadiyah area; detailed analysis of vehicles included in section (3); no signs of decontamination activity.</li> </ul>
2	Al Hadithah Site Command/ Ammunition Depot West	<ul style="list-style-type: none"> <li>-Covered stakebed trucks 2002</li> <li>-Former CW storage <sup>(a)</sup></li> <li>-clean-up efforts 2002</li> </ul>	<ul style="list-style-type: none"> <li>-Imagery indicated site was entirely looted and destroyed. No ISG exploitation.</li> </ul>
3,4	Al Musayyib Barracks Brigade Headquarters and Ammunition Ordnance Depot <sup>b</sup>	<ul style="list-style-type: none"> <li>-Presence of Samarra'-type vehicle late 2001-Aug 2002</li> <li>-Transshipment with stakebed trucks and Samarra'-type vehicle mid-2002</li> <li>-Separately secured area</li> <li>-Grading of the area July 2002</li> <li>-Decon/washdown trenches near entrance</li> </ul>	<ul style="list-style-type: none"> <li>-Thorough investigation of site, to include multiple site visits, debriefing of former military employees, and extensive document review.</li> <li>-Detailed findings included in section below.</li> </ul>
5	Baghdad Ammunition Depot Taji <sup>b</sup>	<ul style="list-style-type: none"> <li>-Transshipment with stakebed trucks and tanker truck 2002</li> <li>-Internal security tents with tanker truck Nov 2002</li> <li>-Presence of tanker truck</li> </ul>	<ul style="list-style-type: none"> <li>-Multiple site visits, bunkers searched.</li> <li>-Found 81mm rockets, aluminum tubes referred to in Powell's speech</li> <li>-Air delivery bombs, rockets exploited.</li> </ul>
6	An Najaf Storage and Ammo Depot Area <sup>b</sup>	<ul style="list-style-type: none"> <li>-Increased security after Husayn Kamel defection in August 1995</li> <li>-Presence of Samarra'-type vehicle 1996</li> <li>-Munitions transshipment June 1998</li> <li>-Dispersal activity within secured area 1999</li> </ul>	<ul style="list-style-type: none"> <li>-Multiple visits by ISG.</li> <li>-Unusual fuel air bomb discovered by onsite contractors.</li> </ul>
7	Ar Rutbah Storage Facility	<ul style="list-style-type: none"> <li>-Transshipment with covered stakebed trucks in 2002</li> <li>-Dispersion of munitions within depot Jan 2003 involving Samarra'-type vehicle, stakebed truck, and probable security vehicle</li> <li>-Presence of Samarra'-type vehicle</li> </ul>	<ul style="list-style-type: none"> <li>-Imagery indicated site was looted</li> <li>-Remaining munitions cleared by 82<sup>nd</sup> ABD and EODT a US EOD contractor</li> <li>-No ISG exploitation.</li> </ul>

82nd ABD = 82nd Airborne Division  
120th EN = 120th Engineers  
EODT = Proper name of a US contractor  
EOD = Explosives Ordnance Demolition  
UXO = Unexploded Ordnance



Figure 7. Ammunition depots of interest (continued).

	Depot Name	Pre-OIF "Indicators"	ISG Investigations
8	H-3 Ammo Storage Depot West	<ul style="list-style-type: none"> <li>-CW storage at H-3 NW in 1991</li> <li>-Stakebed truck transshipment in 2002</li> </ul>	<ul style="list-style-type: none"> <li>-Remaining munitions cleared by 82<sup>nd</sup> ABD and EODT a US EOD contractor</li> <li>-No ISG exploitation.</li> </ul>
9	Habbaniyah Ammo Depot	<ul style="list-style-type: none"> <li>-Transshipment with stakebed trucks and tanker truck 2002</li> </ul>	<ul style="list-style-type: none"> <li>-Few structures remain. 100 tons of UXO with sub munitions in the mix.</li> <li>-Being cleared by 120<sup>th</sup> EN and Naval EOD, no WMD reported by EOD experts.</li> <li>-No ISG exploitation.</li> </ul>
10	Qabatiyah Ammo Storage Depot	<ul style="list-style-type: none"> <li>-Samarra'-type tanker truck attached to engineer platoon 2002</li> <li>-Transshipment with stakebed trucks 2003</li> </ul>	<ul style="list-style-type: none"> <li>-Imagery indicated site was entirely looted and destroyed.</li> <li>-Remaining munitions cleared by US forces.</li> <li>-No ISG exploitation.</li> </ul>
11	Qubaysah (Muhammadiyah) Storage and Ammo and Scud Depot	<ul style="list-style-type: none"> <li>-Transshipment with covered stakebed trucks in 2002</li> <li>-Transshipment with stakebed trucks and tank truck 2003</li> </ul>	<ul style="list-style-type: none"> <li>-Bunkers destroyed</li> <li>-Site reduced by US forces</li> <li>-No ISG Exploitation</li> </ul>

<sup>a</sup>Stored empty 122 mm chemical rockets in 1991, AALD-500 bombs late-1980s.

<sup>b</sup>Highlighted in Secretary of State Powell's speech to the UNSC.

**Figure 7. Ammunition depots of interest (continued).**

*This page intentionally left blank.*



## Annex A IIS Undeclared Research on Poisons and Toxins for Assassination

### The Iraqi Intelligence Service (IIS) M16 Directorate—Iraq’s Undeclared Poisons and Toxins Research

*The IIS M16 directorate utilized a set of covert laboratories to produce, research, and test various chemical compounds, including the BW agent ricin. While there is no definitive evidence that M16 scientists produced CW agents in these labs, the M16 directorate may have been planning to produce several agents including sulfur mustard, nitrogen mustard, and Sarin.*

- Site visits to several M16 labs, safe houses, and disposal sites have turned up no evidence of CW-related production or development, however, many of these sites were either sanitized by the regime or looted, limiting the obtainable information from site exploitations.
- ISG has had to rely heavily on sensitive reporting to understand the activity that took place at these sites, and there has only been limited, uncorroborated reporting that the M16 had produced CW agents. Several reports have stated that ricin was produced at one of these sites in the early 1990s.
- A former IIS officer claimed that the M16 directorate had a plan to produce and weaponize nitrogen mustard in rifle grenades, and a plan to bottle Sarin and sulfur mustard in perfume sprayers and medicine bottles which they would ship to the United States and Europe. The source claimed that they could not implement the plan because chemicals to produce the CW agents were unavailable.

*ISG assesses that the IIS used these labs to develop substances that kill or incapacitate targeted individuals. Intentions of senior regime leadership with regards to these labs have been difficult to determine*

---

### Chemicals Used for Assassinations

*ISG has found evidence that the IIS utilized chemical materials to carry out assassination operations in the late 1980s and early 1990s.*

- *A former IIS officer said that Muhammad Khudayr al-Dulaymi took an auto injecting syringe in the shape of a pen that can deliver a lethal amount of a toxic substance to Europe in 1988, but ended up not using the device. The same source said a similar device was taken to the UK in 1987.*
- *The device was developed by the M9 directorate, which would later become the M16 chemical directorate. The former IIS officer said that the director of M9, Muhammad Munim al-Azmerli, would personally fill the device with either snake venom or nitrogen mustard before giving it to an M4 officer to use overseas.*
- *A former IIS officer claims that Muhammad Munim al-Azmerli used ricin produced at the M16 Rash-diya site to perform assassinations in 1993.*

*However, we have not come across information suggesting chemical or biological materials have been used for assassinations in recent years.*

- *ISG has obtained a large body of evidence which suggests that the M14 directorate was responsible for assassination operations, including the assassination attempts on George Bush and Husayn Kamil.*
- *Little reporting exists on what chemicals, if any, the M16 directorate provided other IIS officers. However, the director of M16 from 1996 to OIF, Nu'man Muhammad al-Tikriti, claims that the only chemical M16 provided other directorates was a sleeping agent he gave M5 officers in 2002.*
- *In the large body of reporting we have on the M16, cooperation with M14 officers is rarely mentioned. Furthermore, none of the IIS sources with direct access we have spoken to have told us they knew of chemical substances given to the M14 directorate to use in assassinations.*

*due to the compartmented nature of the work.* ISG judges that these small-scale endeavors were not part of a WMD program.

- The M16 chemical preparation division was responsible for producing and testing these substances of interest. A recovered document lists the chemical preparation division's tasks which include developing substances which kill and paralyze, and concealing these chemicals in food and beverages. ***What IIS officers have told ISG about the chemical preparation division is consistent with this documentary evidence.***
- The same document lists less than a dozen individuals as being employed by the chemical preparation division in 1999. IIS officers in other sections of M16 were either unaware of the chemical preparation division's activities or unwilling to discuss them, as several IIS officers did not even list it as one of M16's divisions.

### **Purpose of IIS CBW Research**

***We assess that the M16 chemical preparation division was not used as the method for maintaining the technical expertise required to restart a large scale CBW program, because M16's work was limited to laboratory scale production.***

- M16 scientists employed in the chemical preparation directorate would have the knowledge to produce CW agents on a small scale given their scientific training, the link the IIS had to Iraq's early CW program, and the availability of covert chemical labs and equipment.
- These scientists focused on lab-scale chemical work, which would mean they would be less capable to manufacture CW on a large industrial scale than the engineers involved in Iraq's pre-1991 CW program.

***Several scientists in the M16 directorate likely had the expertise to produce laboratory scale amounts of CW agent, and the directorate had sufficient laboratory equipment available to engage in CW research and development.***

- Exploitation of the M16 headquarters building revealed that the directorate had large amounts of laboratory glassware and analytic equipment, which could be used for both legitimate work such as food testing and forensic analysis, and illicit CW production and development. However, precursor chemicals required for CW agent production were not found among the various chemicals located at the headquarters building or its storage site in Djerf al-Naddaf.
- Iraq's pre-Gulf war CW program had a heavy IIS involvement prior to being relocated to the Al Muthanna facility. Some of the scientists who worked on CW agent production prior to the Gulf war still had ties to the M16 directorate at the time of OIF.

***There are indications that the former regime intended to use the M16 to retain the capability to produce CW agent on a small scale that would not be militarily significant.***

- According to a former IIS officer with direct access to the information, a four man team was created in 1995 to produce CW agents on a small scale. The source believed that the secret IIS lab work was initiated by Saddam Husayn who tasked the director of the IIS to set up the program.
- The same source reported that Iraq dismantled its capability to mass produce CW agent in favor of retaining the ability to produce smaller, batch scales of agent at covert labs. The source claimed that the IIS possessed the equipment and chemicals necessary to produce CW agents. ***We believe that this report is only speculating on a plan to retain a CW production capability, because the source has stated several times that the IIS lacked the necessary precursors to produce chemical agent.***

### **Future Plans To Produce CW Agent**

***ISG is unable to corroborate the sensitive reporting that the IIS was planning to produce nitrogen mustard, sulfur mustard, and Sarin, but assesses that if plans to produce chemical agent within the IIS existed, the M16 chemical preparation division would have been the group tasked with carrying them out.***

- A former Iraqi intelligence officer reported that the M16 chemical preparation division planned to produce and weaponize nitrogen mustard using CS rifle grenades. The source provided ISG with two grenade launchers and cases of CS grenades he claimed M16 officers were supposed to modify.
- The same source later reported that the IIS had a plan to produce Sarin and sulfur mustard, which the IIS planned to distribute to the US and Europe. The source claimed that the director of M16, Nu'man Muhammad al-Tikriti, gave him a perfume-bottling machine that was to be used to help carry out this plan.

Both of these plans are extremely difficult to corroborate because:

- *The reporting on this activity states it was never carried out.*
- *According to the source of the above information, only Fadil Abbas al-Husayni, Adnan Abdul Razzaq, Nu'man Muhammad al-Tikriti (the director of M16), and Tahir Jalil Habbush (the director of the IIS) knew details about the plans to produce chemical agent within M16. (See figures 1 and 2.)*

### Covert Labs and Related Activity

*Exploitations of IIS sites have corroborated the story that the chemical preparation directorate was involved in the research and development of chemical materials, but was not producing CW at the time of OIF.* Exploitation teams have visited several laboratories, storage areas, and destruction sites, but have only recovered materials which indicate the chemical preparation directorate was involved in the production of chemicals used for assassination or incapacitation purposes.

*The activity which took place at the various sites focused mainly on the production of chemicals and the testing of these chemicals on animals and identifying their effects on food and beverages.*

- Multiple reports and a recovered lab notebook show that the M16 chemical preparation division

researched a variety of chemicals including: Fluoroacetate, nitrosoamine, strychnine, thallium chloride, and various pharmaceutical products.

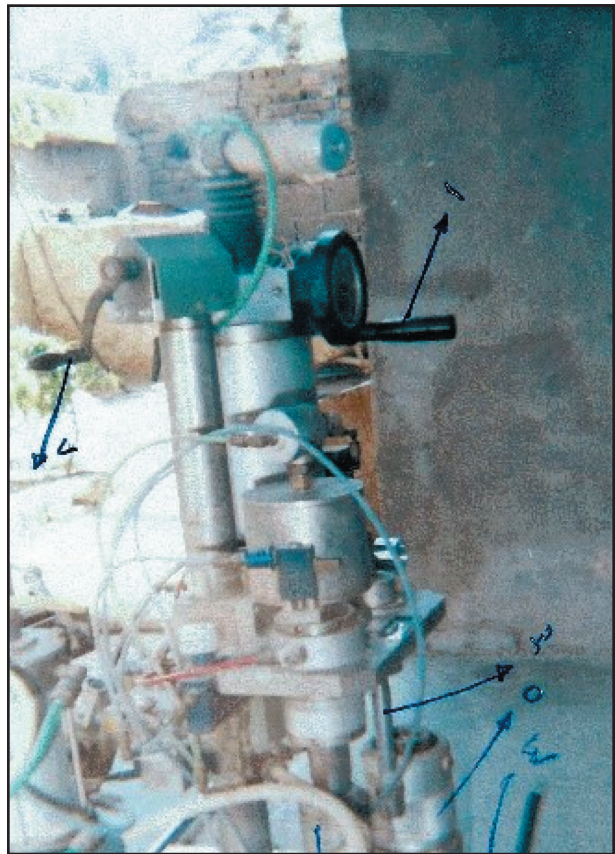
- According to a recovered document, the chemical preparation division was separated into two groups: One that produced the chemicals and one that tested the intelligence applicability of a chemical.
- Reporting states that persons associated with the intelligence application group tested chemicals on mice, rats, rabbits, and pigs, and mixed chemicals with various foods to see if it changed the appearance or smell of the food (see figures 3 and 4).

***The M16 chemical preparation division changed locations significantly during the past 12 years, which may have been done to avoid UN inspectors.***

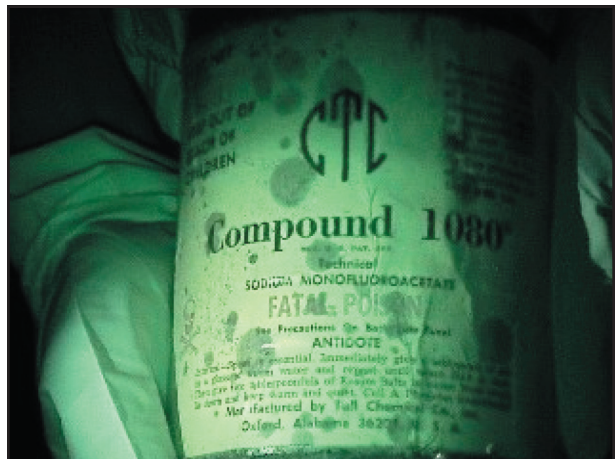
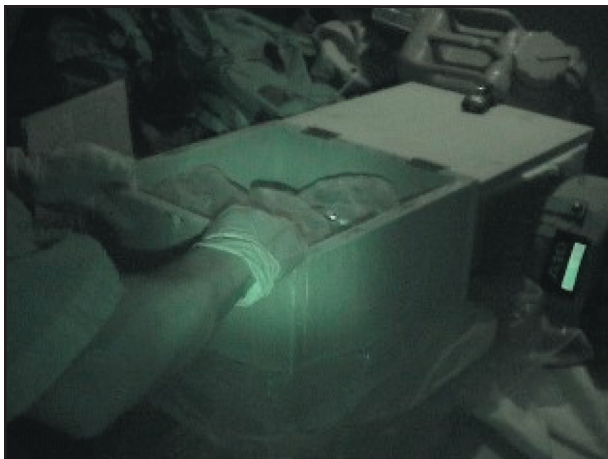
- From 1991 to 2003 the M16 chemical preparation division moved 5 times, from Rashdiah, to Djerf al-Naddaf, to the headquarters building in Karrada, to a small house in Taji, and finally to a residence in Mustansariyah where the final operations of the division took place.
- Reporting says that a fear of the UN was the driving force for some M16 activity, such as concealing chemicals or closing down the Rashdiah site.

**Rashdiah (N 33 32 03.0 E 044 20 26.4)**  
***The Rashdiah site was an active M16 site from 1991 to some point in the mid 1990s where the chemical preparation division researched ricin and other, non-CBW related chemicals.***

- Reportedly, ricin, PCP, and Hyoscine, a chemical extracted from the Datura plant, were researched at the Rashdiya site.
- Reports state that the Rashdiah lab was eventually closed in the mid-1990s and moved to the Djerf al-Naddaf facility.
- A former IIS officer listed the Rashdiah "Fish Research Center" site as being a secret laboratory used by the IIS.



**Figure 1 (left) and Figure 2 (right).** Perfume bottles and bottling machine reportedly intended to weaponize Sarin and sulfur mustard to use against the US and Europe.



**Figure 3 (left) and Figure 4 (right).** In early May 2003, a sensitive source gave coalition forces a box of chemicals he claimed the IIS M16 preparation division was researching. The chemicals were meant for assassinations or to assist in kidnapping.

***The absence of laboratory equipment or chemicals is more likely the result of the facility not being utilized by the M16 since the 1990s, rather than being caused by looting or sanitization efforts prior to OIF.***

- An exploitation of this site in April 2003 uncovered chemical-resistant countertops and evidence of a former air handling system. No other signs were evident that this facility had been used as a chemical laboratory.
- Much of the chemicals and equipment present at this facility were likely moved when the IIS departed this site. A former high-level member of the Iraqi government with direct access to the information said that the IIS operated the lab from 1992-1995.

***Ricin and other chemicals were probably produced and tested on mice and rats at the Rashdiya site in the early 1990s. The amount of ricin produced at the site was no greater than a few kilograms.***

- A high-level IIS source claimed that Adnan Abdul Razzaq al-Ubaydi produced as much as 3.5 kg of ricin in 1992, which was partially used by Doctor Muhammad Abdul Munim al-Azmerli for assassinations in the early 1990s. The source claimed that he saw the ricin, and Razzaq personally informed him about the amount produced.
- A mid-level IIS lab worker with direct access supported the Ricin production claim, and estimated that Razzaq produced 2 kg of Ricin at the Rashdiya site.

***We have received conflicting reports about what happened to the ricin produced at this site, and have been unable to retrieve any of the chemical.***

- The IIS source gave two different accounts of what happened to the ricin, in June 2003 he said that the ricin produced was given to the director of the IIS, but in September he claimed that Abdul Munim al-Azmerli took possession of the ricin when the IIS left the Rashdiyah lab.
- A detainee who was a high-level member in the IIS said that the ricin research was halted on the order

of Husayn Kamil, and the research turned over to Dr. Rihab Taha. The source claims that the ricin produced at the lab was destroyed.

***We believe that a detainee who claims only milligrams of ricin was produced at the site is either unaware of the extent of M16's work on the substance or trying to downplay the quantity of the production.***

- A detainee who was a high-level member in the IIS informed ISG that Adnan Abdul Razzaq al-Obaydi produced ricin at a site 35 miles North of Baghdad (likely referring to the Rashdiyah lab). Razzaq reportedly produced a few milligrams of ricin in 1992 while researching his thesis on the extraction of toxins from natural substances.
- The high level member of the Iraqi government who said that 3.5 kg of ricin was produced in 1992 also said that only a small sample of ricin was produced by 1991. The detainee sourced above may have only been aware of the scientist's progress up to 1991.
- Reportedly, chemicals produced at the Rashdiyah site were tested on mice and rats, which would have been unlikely to occur with ricin if only milligram amounts were produced (see Figures 5 and 6).

***Djerf al-Naddaf (N 33 15 15.1 E 044 33 08.3)  
The M16 moved its operations from Rashdiyah to Djerf al-Naddaf in the mid-1990s where scientists continued the production and testing of chemicals. The site appeared to be sanitized when a coalition team exploited it, but the IIS may have removed laboratory materials several years ago when they left the site.***

- According to a former BW scientist, an NMD official went to the Djerf al-Naddaf site in 1997 or 1998, and though he was not allowed in the facility, he believed it was involved in biological research because he saw people he knew from the IIS.



**Figure 5 (left) and Figure 6 (right).** The Rashdiya site was where the IIS produced ricin in the early 1990's, but no evidence of recent illicit activity was uncovered during the site visit.

***A report states that M16 produced small amounts of Sarin and Tabun at this site in 1997, which they were later ordered to destroy by the director of the IIS. While we have strong evidence indicating an IIS chemical destruction committee existed at this time, we are unable to verify that Sarin and Tabun were among the chemicals destroyed.***

- The director of the IIS created a committee to destroy the chemical agents and any related production equipment, which was later carried out at the Djerf al-Naddaf site, according to a senior IIS official.
- We have been able to verify that Muhammad al-Qaisi, who the source claimed was on the committee that destroyed the CW agent, probably worked on explosives for M21 during 1997. M21 later merged with the M16 directorate around 2000.
- A document recovered discusses a committee that destroyed 4 containers of Phosgene, a CW agent and precursor, in 1997. On the committee was an M21 officer named Muhammad Shukr, this is probably Muhammad Shukr al-Qaisi, who was later employed by M16 according to a separate document.

- The director of M16, Nu'man Muhammad al-Tikriti, admitted that he ordered the M16 directorate to destroy several mustard and nerve-agent precursors in the 1996-97 time frame, but he did not say they destroyed Sarin or Tabun. According to Nu'man, the chemicals were destroyed because they were on a list of prohibited materials given to him by the National Monitoring Directorate.

#### **M16 HQ (N 33 17 00.9 E 044 24 32.0)**

***The M16 headquarters building in Karada housed several labs and contained chemicals and chemistry equipment, but the sensitive reports we have on activity at this site do not indicate that CBW research or development was taking place.***

- A former IIS officer with direct access claims that the M16 Headquarters building was used to produce biological weapons, but the source seems to lack knowledge about biological sciences, and a device he describes as being used to produce BW is probably a device used in analytic research.

***The headquarters building contained several chemical and biological laboratories, but apparent sanitization efforts of the site make the purpose of the laboratories difficult to determine from exploitation data alone.***

- The April 2003 exploitation team found a microbiological lab capable of growing small amounts of bacteria, analytical equipment, and laboratory chemicals such as solvents. According to the exploitation report, items appeared to have been removed from the site, and shredded documents were present throughout the building.
- A family that moved into the former M16 headquarters building said that after the coalition's primary visit to the facility in April, IIS personnel returned to pick up several items including computers and equipment. Sanitization efforts may have continued, because the team that returned to the site found burnt documents in October 2003.
- Documents recovered at the M16 headquarters building include scientific texts on the extraction of toxic compounds, pesticides, detection of toxins in food, water contamination, microbial agents, and laboratory notebooks.
- A few of the documents recovered indicate that M16 was interested in CW-related dual use technology such as organophosphorous chemistry. A thesis on the production and physiological effects of ricin and Hyoscine was also found on site. The paper was prepared by M16 officer Adnan Abdul Razzaq in the early 1990s (see Figures 7, 8, 9, 10, and 11).

*The equipment, chemicals, and literature found at the site are consistent with sensitive reporting on the activities of the M16's chemical forensics division, which does not have strong ties to CBW research or the development of assassination-related compounds.*

- The M16 chemical forensic division was responsible for testing food for the regime. Other reports corroborate that there was an M16 division which had the ability to analyze chemical substances and test food and other items for the presence of poisons and toxins.
- According to a senior IIS official who has reported reliably in the past, this building served as the M16 headquarters, where research on toxins and their properties took place. However, the same source stated that the work was solely for defensive purposes.
- Laboratory analysis of several samples taken at the site revealed that the M16 had samples of potassium cyanide, the pesticides diazinon and Malathion, the herbicide glyphosate, and several other innocuous chemicals. *It would not be unusual to find these chemicals at a laboratory examining foodstuffs for poisons or contaminants, because such a lab would need standards to which it could compare analytic results.*

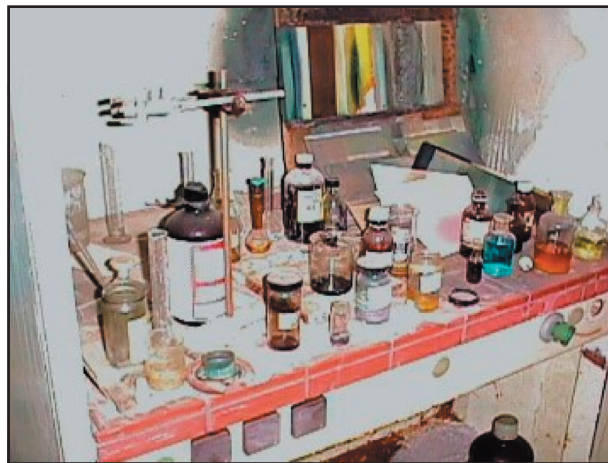
### Illicit Activity at M16 Headquarters

*The chemical preparation division may have produced chemicals which were used on IIS prisoners or unknown Kurdish individuals when it was located in the M16 headquarters during the late 1990s.*

- An IIS officer with said that the director of M16, Nu'man Muhammad al-Tikriti, may have provided dimethyl nitrosoamine to the director of the SSO in July 2000 for use against 4 unidentified Kurdish citizens.
- The same source claims that Adnan Abdul Razzaq al-Ubaydi used dimethyl nitrosoamine on prisoners under the control of the IIS M7 directorate starting in 2000.
- The source informed ISG that when located in the Karada district, the IIS M16 chemical preparation division worked exclusively on producing dimethyl nitrosoamine, a substance which, according to the source, can cause lung and liver cancer within three months.

### Taji Lab (N 33 22 49.3 E 044 18 59.2)

*The chemical preparation division's lab in Taji focused on the research of three chemical substances, but the purpose of opening the lab may have been to give the division a covert location to produce CW agent for the regime.*



**Figure 7 (top left), Figure 8 (top right) and Figure 9 (bottom right).** The M16 headquarters building contained several small laboratories that appeared to be involved in analytic chemistry work.



**Figure 10 (left) and Figure 11 (right).** The headquarters building contained a large amount of chemical laboratory equipment, but the lack of CW precursor chemicals makes it appear that the scientists at this site were not involved in CW research or production.



- The IIS M16 laboratory located near Taji was opened in 2000 for the purpose of producing nitrogen mustard, according to a former IIS scientist. The five individuals assigned to work at the lab lacked the necessary chemicals to produce nitrogen mustard, so they worked on a plant-based anesthetic per the order of M16 director Nu'man Muhammad al-Tikriti.
- The source said that while they were waiting for Adnan Abdul Razzaq to send back precursor chemicals to produce the CW agent, the division researched the compounds dimethylnitrosoamine, a mixture of fluoroacetate and thallium chloride, and a natural anesthetic extracted from the datura plant.
- An exploitation team that visited this site found a non-residential drainage system and signs that chemical ventilation had been present, which help corroborate the source's claim that the house was used as a laboratory.
- A former IIS scientist who worked at the Taji lab said that the lab was shut down and all the equipment removed when the US issued its ultimatum to Saddam Husayn to leave Iraq in 48 hours (see Figures 12, 13, and 14).

#### **Mustansariyah (N 33 21 17.9 E 44 24 41.0)**

*The Mustansariyah site was the chemical preparation directorate's final location, where the burial and destruction of chemicals took place. Research activity on chemicals was minimal at this site.*

- The M16 director, Nu'man Muhammad al-Tikriti, said that when the officers in the chemical preparation directorate were based at the Mustansariyah house in 2002, they did not do any notable chemical work and spent most of their time destroying old chemicals and moving other chemicals and equipment to a storage site in Djerf al-Naddaf.
- A house in Mustansariyah received equipment from the lab in Taji and CW precursors in late 2002, according to a former IIS officer with direct access to the information. The source believed that nerve agent production was being researched at the site,

experiments occurred on the roof of the house, and that chemicals were buried on the property.

- We assess that this source had direct access to the movement and burial of chemicals, but we believe the source does not have authoritative access on information about the identities of chemicals involved or the research activities of the Mustansariyah house. The small time frame that the IIS was at the site, combined with the time constraints of setting up a chemical lab, make it unlikely that extensive research took place at this site.

*The exploitation of this site found a few items indicating that the Mustansariyah had supported IIS chemical-related research, but the site was mostly empty.*

- In April 2003 an exploitation team visited the Mustansariyah site where it found IIS documents and a few laboratory-related items and chemicals, but nothing appeared to be CBW related. The site was mostly empty, and appeared to be recently cleaned and painted.
- A high level member of the Iraqi government with direct access to IIS activity accompanied the exploitation team and pointed out several rooms that were used for laboratory chemical storage, but the rooms were empty leaving the impression that the chemicals had been previously relocated.
- On the roof of the Mustansariyah building, the exploitation team found chemical-resistant countertops, chemical fume hood face plates, and spare parts for fume hoods.
- On the perimeter of the Mustansariyah site, the exploitation team recovered a box of medication that was used to cause pain, humiliation, or death in Saddam Husayn's adversaries, according to a high level member of the Iraqi Government that had direct access to the information (see Figures 15 and 16).



**Figure 12 (top left), Figure 13 (top right) and Figure 14 (bottom right).** The M16 site in Taji appeared to be sanitized by the time it was inspected by the ISG, although some physical evidence corroborated the source's claim that the house formerly housed a laboratory.



**Figure 15 (top left) and Figure 16 (top right).** No suspect chemicals were found at the Mustansariyah site, but the presence of chemical countertops and Kotterman hoods corroborated the story that the M16 planned to use this site for chemical laboratory work.

*Site exploitations have verified that material was buried at the Mustansariyah site, although ISG has been unable to determine the identity of items present at the site.*

- The exploitation team that visited the Mustansariyah site was able to excavate various vials and broken glassware that was buried in the yard, but the contents of these containers could not be verified.
- In September, an ISG exploitation team returned to the site to take various soil samples for analysis, which came up negative for the presence of BW agents or toxins. The samples were not analyzed for the presence of suspect chemicals.
- According to a chemical forensic lab report, no suspect chemicals were found in three contact samples taken from various locations in the house.

**Salmadiyah Warehouses/Burial Site (Djerf al-Naddaf, N 33 15 22.0 E 044 33 03.2)**

*The burial and destruction of chemicals also occurred at two M16 warehouses located near the former M16 facility in Djerf al-Naddaf.*

- IIS officers moved chemicals from a warehouse in the Karada district of Baghdad to be disposed of at a site in Salmadiyah in March 2003, according to reporting. The report stated that chemical containers of various sizes were buried in a deep pit and that several of the containers were broken either during the move or when they were placed in the pit.
- A former IIS officer with direct access to the information reported that chemicals stored at the Mustansariyah site were moved to the warehouses in Salmadiyah where some were destroyed. A burn pit was near the warehouse where IIS officers took some of the chemicals and poured them directly into the ground.
- In a separate report, the same former IIS officer describes the chemicals as being CW components, but the source also describes the chemical components in non-scientific terms, such as “impressive

and beautiful,” which indicates that he probably has little training in chemistry and may not have had direct knowledge about the identity of the chemicals.

- A former IIS chemist with direct access claims that material at the Mustansariyah site was relocated to the Salmadiyah warehouses in 2002.

*The use of these warehouses for the storage of chemicals and equipment was corroborated, but the site was thoroughly sanitized after the first coalition visit, preventing complete exploitation of the warehouses’ contents.*

- An exploitation team visited the site in April 2003 and found two warehouses which contained laboratory chemicals, lab equipment, and documents. The specific chemicals were not detailed in the exploitation report, but no CW agents were present in the warehouses.
- In April 2003, IIS officers destroyed the warehouse which contained the material, according to a former IIS officer with direct access to the information (several other warehouses in the area had already been destroyed by coalition bombing).
- US military officers revisited the site in July 2003, but found that the warehouse had been destroyed (see Figures 17, 18, and 19).

**Karwai Burial Sites (Al Adaim Desert, N 34 13 E 044 31)**

*The IIS buried equipment and chemicals, which may have included CW precursors, at a remote site North of Baghdad in the mid-1990s. ISG has been unable to corroborate that CW-related chemicals were hidden at any of the 5 exploited sites.*

- An exploitation team originally visited the sites in April 2003 where they recovered equipment used for animal testing, and burned CS grenades. Buried chemicals were also located, but the team determined that sample analysis would be unfeasible, so the identity of the chemicals remains unknown.

---

***Iraqi Regime Use of Poisons and Toxins  
on Human Subjects***

***IIS Involvement in Human Testing***

***In the 1970s, and possibly into the 80s, the IIS conducted testing of deadly chemicals on human subjects under the leadership of Dr. Muhammad Abd al-Munim al-Azmerli, the head of the IIS al-Hazen research facility.***

- *Dr. Munim confessed to administering various chemicals to human test subjects from 1975-1980. Dr. Munim stated that former IIS director Barzan al-Tikriti ordered him to carry out the testing program, along with Nu'man Muhammad al-Tikriti (who would later become the head of the M16 directorate in 1996) and Ali Hassan Jasim (who administered the lethal doses).*
- *According to Dr. Munim, the poisons were being developed as assassination tools for use overseas, and that the IIS wanted a substance that would not kill its victim until 5 hours after it was consumed.*
- *A high-level member of the Iraqi government with direct access claimed Dr. Munim used poisons and toxins on approximately 100 prisoners, including Kurds, Iranians, and a Saudi Arabian. The prisoners were given lethal doses of various substances including Lasix and dimethyl nitrosoamine.*
- *Dr. Munim gave political prisoners poisoned food and gave other individuals injections. The officer also said that Dr. Munim tested explosives on human subjects, and that he was a "sick man."*
- *According to sensitive reporting, Dr. Munim tested drugs which affected memory and sexual function on 15 prisoners between 1980 and 1989. Any subjects that survived the drugs given to them by Dr. Munim were later executed.*

***The testing occurred at the M7 directorate's Hakamia prison, where the victims were prisoners who were sentenced to death.***

- *Dr. Munim said that subjects for the testing were provided M7, the directorate in charge of the IIS prison system where enemies of the regime are incarcerated. The M7 directorate was also responsible for interrogations and has been implicated in the torturing of inmates.*
- *Nu'man Muhammad al-Tikriti denied being personally involved with any of the testing activity, but admitted to witnessing Dr. Munim administer poisons to prisoners 10 times in 1983 at the M7 Hakamia prison. Al-Tikriti stated that the poisons included cyanide, methyl micro chloride, thallium acetate, and sodium fluoride. "Methyl micro chloride" probably refers to liquid methyl chloride.*
- *Dr. Munim claimed he tested chemicals on 20 subjects, and used lithium acetate, strychnine, librium, digitalis, and cyanide.*

***The discrepancy between Dr. Munim and Nu'man's stories about the human testing activity may indicate that one or both individuals was not being honest, or could not recall the details about the extent of the activity when discussing it with ISG officials.***

- *The admissions made by Dr. Munim and Nu'man both attempt to downplay the human testing activity. Dr. Munim claimed that the numbers of subjects were small, and Nu'man insisted that he only witnessed the activity and did not participate.*
- *Dr. Munim and Nu'man's stories about the testing at Hakamia are significantly different in terms of dates and materials tested, even though both individuals admitted to having direct knowledge on the activity.*
- *Neither individual's story matches information provided by other sources who described the testing activity.*

---

***Iraqi Regime Use of Poisons and Toxins  
on Human Subjects (continued)***

***DGS Testing of Chemicals on Humans***

***Multiple sources have described testing of chemicals on political prisoners within the Iraq's Directorate of General Security (DGS) during the 1980s and in the early 1990s.***

- A former DGS biologist with direct access to the information said that until 1991 Department 69 in DGS imported toxins and tested them on political prisoners sent from DGS headquarters. This department's official duties were for testing the food of Saddam's inner circle for poisons and contaminants.
- According to reporting, individuals were given milky liquids at a DGS laboratory run by Department 69 which caused them to die within 3-4 weeks.
- A different report states that DGS officers gave milky liquids to political prisoners, who died 40 minutes after consuming them.

***Possible IIS Human Test Site in Baghdad's Karada District (N 33 17 14.8 E 044 25 12.6)***

*ISG has investigated the claim that human testing occurred at a residential house in the Karada district of Baghdad near the Tigris River. We have identified the building that the activity reportedly took place in, but have been unable to corroborate that any illicit activity took place.*

- According to reporting, in July 2001 nine individuals were brought into the house, tied down to beds, and had small tubes placed into each of their arms. The next day all of the prisoners showed signs of bleeding from the mouth. A female doctor gave each of the prisoners an injection, and the next day six of the prisoners were dead.
- The same report said that the doctor performed autopsies on at least one of the victims, which suggests that she was trying to determine the effects of the substances given to him.

- Based on highly detailed information about the location and description of the residence taken from the same report, ISG managed to identify and exploit the suspect facility.

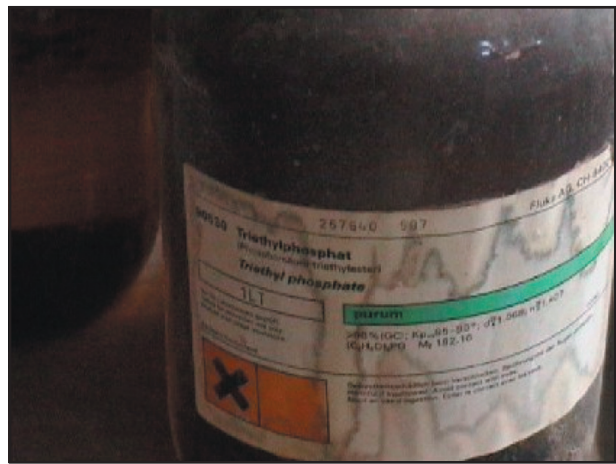
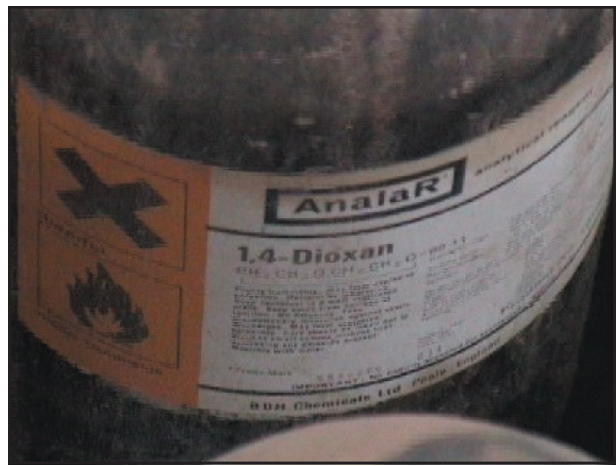
- ISG site exploitation revealed no evidence of human testing or other CBW activity, but the site appeared to be heavily sanitized or looted. All furniture and fixtures had been stripped from the facility, including floor tiles. ***Based on the site layout of the residence, we assess that this is the same facility the sensitive report referred to.***

***We have been unable to identify the exact purpose or owner of this house, but limited information indicates that it belonged to the IIS.***

- Presidential secretary Abid Hamid Mahmud, who was reported to have been at the site in 2001, claimed that the building was used as an IIS guest house.
- During the site exploitation, IIS business cards and partially burned IIS documents were recovered.

***Despite the reporting, we do not believe that this facility was associated with the IIS M16 (M9G) chemical forensics branch.***

- Reportedly, this facility was used by the M9G branch and was involved in the chemical analysis of unknown material.
- This reporting appears to be describing the activities of the chemical forensics division of M16 (formerly known as M9J/M9G). Multiple reports indicate that the chemical forensics division was based in the M16 headquarters building, which is located on the same road but further west.



**Figure 17 (top left), Figure 18 (top right) and Figure 19 (bottom right).** The M16 directorate stored a large supply of laboratory chemicals and equipment at the warehouses in Djerf al-Naddaf, but no CW precursors were present when the exploitation team arrived.

- A team returned in August and excavated chemical containers, but found that several containers had been damaged in the burial process. A high level member of the Iraqi government with direct access claimed that an autoclave and glove boxes were buried at the site.
- The same source, which led the team to the site, claimed that the IIS buried the CW precursor thionyl chloride, thionyl diglycol (which may be a reference to the CW precursor thiodiglycol), glassware, and chemical protective gear at the site in 1994 and 1998. According to the source, the burial was ordered by Abdul Munim al-Azmerli to hide the chemicals from UN inspectors.
- We have not been able to corroborate the reason material was buried in 1994, but Nu'man Muhammad al-Tikriti stated that chemicals were buried during the 1996-1997 timeframe in this area because they were on a list of prohibited materials provided by the National Monitoring Directorate (see Figures 20 and 21).

#### **M16 Procurement Efforts**

*The M16 directorate utilized several different avenues to obtain chemicals and equipment, but faced difficulties procuring illicit materials or items that would draw attention to the directorate's work.*



**Figure 20.** Various buried chemicals were located at the burial sites.



**Figure 21.** A Skinner Box, a device used to test small rodents who are under the effects of drugs or chemicals, was recovered at one of the sites.

- A high level member of the Iraqi government with direct access to the information claimed that IIS officer Adnan Abdul Razzaq was sent to Russia to set up a procurement network to provide the M16 directorate with CW precursors.
- Nu'man Muhammad al-Tikriti said that the M16 directorate never tried to procure CW precursors during his tenure as M16 director. He said that the M16 had a significant store of chemicals in the Djerf warehouses that it used, and M16 scientists got any additional chemicals it needed from unspecified Iraqi ministries.

***We have no evidence to suggest that M16 used M4, the IIS directorate which has been linked to assisting Iraqi procurement efforts, to obtain prohibited CW chemicals or equipment.***

- Nu'man Muhammad al-Tikriti claimed that M16 met with M4 sources on a few occasions to obtain equipment for M16, but none of the materials Nu'man discussed were prohibited.

- A former IIS officer with direct access said that Nu'man Muhammad al-Tikriti, the head of M16, attempted to get several chemicals through M4 in 1998 including the CW precursor thionyl chloride. The source claimed that M4 was unable to get the requested chemicals.
- A recovered document discusses an M16 request for laboratory equipment and chemicals in 2001. The document recommends M4 do a feasibility study to find out if one of their foreign agents could assist in getting M16 the items it needed.
- A former mid-level IIS officer said that M4 provided technical papers to the M16 directorate, but did not get any chemicals or equipment for the directorate. The source said that M16 had its own procurement group that made trips out of the country to purchase equipment.

**Assassination Pen Found at al-Karwai (N 34 14 34.9 E 044 031 32.0)**

*The pen-shaped auto injector recovered at al-Karwai may have been one of several such devices the IIS had to perform assassinations of the former regime's key targets.*

- A former IIS scientist with direct access to the information stated that the IIS developed pen-shaped devices meant to be used for assassinations. Muhammad Khudayr al-Dulaymi, the director of IIS special operations, took one of the devices to London in 1988 for an assassination, but did not use it.
- The same source claimed that Abdul Munim al-Azmerli gave the order to create the devices, which were produced from 1981-1985.
- An ISG exploitation team recovered a device that matches the description of those requested by Azmerli buried at al-Karwai with other IIS materials. The device was tested for the presence of chemicals, but none were found.
- The large needle on the device makes it appear poorly suited for covert assassinations, and the former IIS scientist said that the device's original use was for animals. This may indicate that the IIS decided to alter a pre-existing device, rather than develop its own specially designed for human targets.

**Other M16 Burial/Disposal Sites**

*A source led a coalition exploitation team to a site near Musayyib where chemicals may have been buried to avoid detection by UN inspectors.*

- No CW related materials were recovered, but the team found a large amount of chemicals buried at the site. The sensitive source claimed that the M16 buried the chemicals in 2002 because the IIS was worried the UN would think the M16's chemical stores were too extensive for legitimate use.

- The head of M16, Nu'man Muhammad al-Tikriti, claimed that he directed M16 officers to bury chemicals in 2002 because they were old and were no longer useful to M16 scientists (see Figures 22 and 23).

According to reporting, the director of the IIS research center, Numan al-Nasiri (likely Nu'man Muhammad al-Tikriti, the director of M16), was seen burying syringes, vials of liquid, cans, and bags of chemicals in March 2003. Nu'man buried the items with at least one other IIS officer at a location near the al-Samida depot and gave the specific GPS coordinates. *ISG assessed that this reporting did not merit full exploitation due to its inconsistency with other M16 burial reporting and the source's indirect access to the information.*

**Historical IIS Ties to Iraq's CW program**

*The IIS likely had the technical knowledge to produce several CW agents, including Sarin and sulfur mustard, because the IIS was instrumental in starting Iraq's CW program in the 1970s.*

- One IIS officer we spoke with was able to mentally recount the formula for producing Sarin nerve agent, despite not having worked on CW production in recent years.
- Iraq's FFCD states that efforts to produce CW agent began at the al-Rashad site, where researchers were able to produce lab-scale amounts of mustard, Tabun, Sarin, and various pesticides.
- According to a former Iraqi Ministry of Defense scientist, the IIS began to research organic phosphates at the al-Rashad facility in 1974. A team of approximately 50 scientists worked to produce mustard gas at the location, and the effort was led by Dr. Muhammad Munim al-Azmerli.





**Figure 22.** Tank of triethylamine recovered near Musayyib.



**Figure 23.** Large amounts of buried chemicals were located at the Musayyib site.

- A former Iraqi Intelligence officer with direct access to the information said that Dr. Munim obtained the equations for producing chemical weapons and established laboratories in Salman Pak during the 1980-82 timeframe where he worked on Sarin, sulfur mustard, nitrogen mustard, and tear gas (CS).
- The IIS CW lab in Rashad which was operational from 1974-1979 was relocated to Samarra in 1980, and then moved to Salman Pak in 1983 according to a former IIS chemist. The same source stated that CS (tear gas) and Sulfur Mustard were provided by the IIS researchers to the Iraqi military to use during the Iran-Iraq war.
- Dr. Munim stated that the IIS chemical warfare research lab was located in al-Rashad from 1974-1979, but was move to Samarra in 1980 and then later to Salman Pak.

*This page intentionally left blank.*

## **Annex B Al Muthanna Chemical Weapons Complex**

### **Background: Evolution of Iraq's Chemical Weapons Development Facilities**

*Iraq's pursuit of chemical and biological warfare programs dates back to the early 1960s when members of the armed forces traveled overseas, including to the US and UK, in pursuit of CBW training.* From this training, Iraq formed the Chemical Corps. With this foundation and a change in political power from the Ba'thist revolution in 1968, Iraq began a campaign of organized research and development into an infant CBW program.

- Junior Army officers were trained in United States and Russia in chemical warfare during the 1960s. The Iraqi army then formed the Chemical Corps.
- A division of opinion evolved in the chemical corps where the more Senior Officers desired only a defensive CW program while Junior Officers favored both an offensive and defensive program. This rift in leadership opinion continued into the 1970s.
- The Ba'thist revolution forged contacts among Junior Officers of the chemical corps and Senior Officers of the Army enabling Iraq to embark upon an offensive CBW program.

*Iraq's first attempt to produce a chemical weapon was a series of failures and limited technological advances.*

- During the early 1970s the Army developed the concept of "Scientific Centers for Excellence." The goal of the project was to develop a chemical weapon, however after four years of poorly organized research, the project failed to achieve the development of a chemical weapon.

*The desire to undertake an offensive CW program continued, and a more organized approach to produce a chemical weapon began in 1974 under the*

*military leadership and Iraqi Intelligence Service (IIS) oversight. In 1975 the Al Hasan institute (the first laboratory devoted to the development of CBW) was formed. Its main laboratory was at Al Rashad in suburban Baghdad.*

- The Al Hasan Institute was founded as the nucleus for chemical research dedicated to CW development.
- Al Hasan was funded by the government through the Ministry of Higher Education, not the military.
- The Al Hasan Institute was intimately supported by the IIS. The project was not just a Chemical Corps project.

Two key military personnel founded the Al Hasan Institute, the first laboratory devoted to the development of CBW.

- Ghassan Ibrahim, a captain in the chemical corps, formed the Al Hasan Institute.
- Faiz 'Abdallah Al Shahin, an Intelligence Officer, was Ghassan's assistant.

*The institute established a mentorship and overseas training program to foster better-trained scientists and chemical corps officers.*

- Some of the more prominent Iraq chemical weapons experts received their PhDs from the Chemical Warfare Academy in Moscow from 1973 to 1979.

—Dr. 'Imad Husayn 'Abdallah Al 'Ani (Research and Development)

—Dr. Salah-al-Din 'Abdallah (Weapons Design Expert and Toxicity Research)

—Dr. Hammad Shakir (Weapons Preparation Expert)

*Iraq's second organized attempt at CBW production ended abruptly in a scandal and the Al Hasan Institute was abolished in 1978.*

- The founder of the Al Hasan Institute and a number of staff were imprisoned for fraud and embezzlement.
- The program, though it made substantial advancements in CW research and development, never succeeded in CBW production. The program ultimately failed to meet expectations.

*Project 1/75 evolved from the Al Hasan Institute and began to materialize after 1978. Project 1/75 eventually evolved into Iraq's third and most successful attempt in developing a viable and productive CBW program. Funding came from a different ministry, leadership was changed, and resources became more remotely located away from Baghdad.*

- Project 1/75 was a remnant of the Al Hasan Institute and started as a small facility 40 km SW of Samarra', Iraq.
- The Ministry of Defense funded the project.
- Lt. Gen. Nizar 'Abd-al-Salam Al-Attir spearheaded what later became the largest campaign in the pursuit of chemical weapons in Iraq's history.

*In 1980, after Saddam took power, Project 1/75 was greatly expanded. The project was renamed Project 922. With the Iran-Iraq war looming, Iraq made the CBW program a top priority.*

- German firms were contracted to build equipment and facilities designed for the sole purpose of the safe, efficient, mass production of CBW agents.
- Iraq's elite scientists were recruited. Research groups were coalesced and moved into these facilities near Samarra'.

*To maintain anonymity, Project 922 was known to the Iraqis as a pesticide production company. The State Establishment for Pesticide Production (SEPP) became the front company for Iraq's 100 square kilometer industrial facility dedicated to CBW production.*

- *Project 922 was referred to as the Samarra' Chemical Weapons Production and Storage Complex. The name was chosen because of its close proximity to Samarra', Iraq.*
- *Project 922 was known to the Iraqi community as The State Establishment for Pesticide Production (SEPP).*

- Currently the complex is referred to as Al Muthanna Chemical Weapons Complex.

*Within three years (1978-1981), Project 922 had gone from concept to production for first generation Iraqi chemical weapons (mustard agent). By 1984 Iraq started producing its first nerve agents, Tabun and Sarin. In 1986, a five-year plan was drawn up that ultimately led to BW production. By 1988 Iraq had produced VX. The program reached its zenith in the late 1980s during the Iran-Iraq war. Between 1981 and 1991, Iraq produced over 3,857 tons of CW agents.*

- Initial research under an elite group of chemists focused on mustard, but rapidly progressed into Tabun and Sarin (G-Agents). Production efforts for mustard started at 10 tons of agent production in 1981 and increased roughly 80-100 tons per year until 1985 when the facility annually produced 350 tons. In 1987 Iraq produced almost 900 tons of mustard agents and in 1988 they produced close to 500 tons of agent.
- Iraq produced between 60-80 tons of Tabun annually between 1984 and 1986.
- Eventually they researched Cyclosarin and VX concurrently. In 1984 Iraq produced 5 tons of Sarin. Iraq constantly increased Sarin production efforts. In 1987 and 1988 Iraq produced 209 and 394 tons of Sarin, respectively.
- Cyclosarin was highly desirable to the Iraqis because of its low volatility and the commercial availability of its precursor compound cyclohexanol. These factors gave Cyclosarin several advantages; it was easier to work with in hotter environments, had enhanced efficacy and storage

life, and the precursor compound cyclohexanol was relatively cheap, commercially available, and difficult to control by sanctions.

- Iraq produced 2.5 tons of VX in 1988 before ending production due to the end of the Iran-Iraq War.
- Production for Sarin, VX, and Mustard resumed in 1990.

*During the early years, Egyptian scientists provided consultation, technology, and oversight allowing rapid advances and technological leaps in weaponization. With the Iran-Iraq war well underway, Egypt assisted Iraq in CW production:*

- In 1983, Egypt made modifications to the Grad 122 mm Multiple Launch Rocket System to enable warheads to store chemical agents.
- In 1984, Egypt exported Grad rockets with plastic inserts to hold chemical agent.
- In the mid 1980s, Iraq invited Egyptian chemical weapons experts to Iraq to assist in producing Sarin munitions.

### **Project 922 Becomes Al Muthanna after 1986**

*Project 922 underwent a name change in 1986 when the Al Muthanna State Establishment (MSE) oversaw operations and the facility became known as Al Muthanna (see Figure 1). The secrecy of the facility began to erode in the mid 1980s precipitating a venue change in Project 922's production and research.*

- The BBC Panorama aired the documentary "Secrets of Samarra" on 27 October 1986. Security and secrecy were compromised for this clandestine CW program.
- The original Director General Lt Gen. Nizar was relieved by Fiaz 'Abdallah Al Shahin in 1987 (IIS agent and co-leader of the Al Hasan Institute).

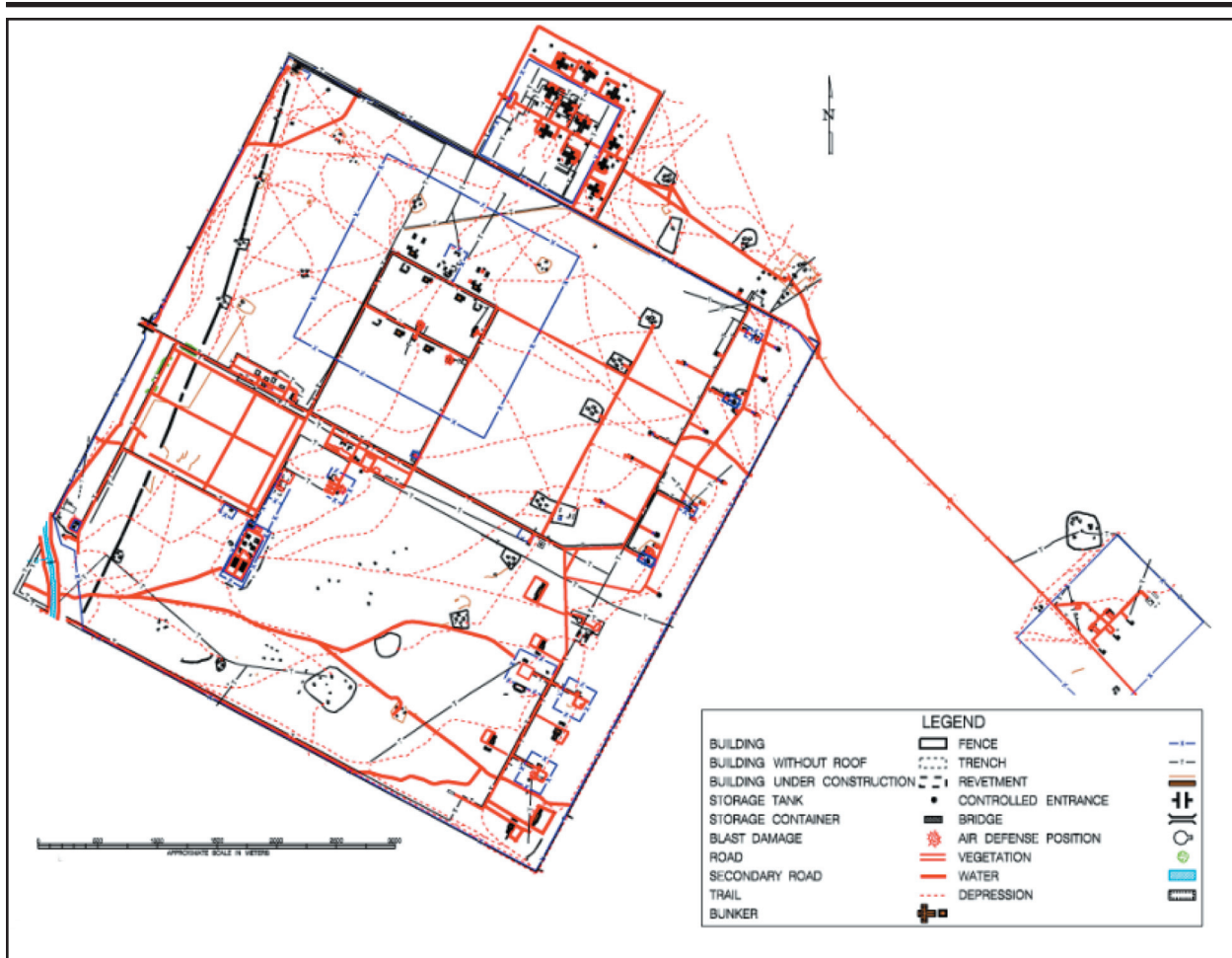
- The Establishment was subordinate to the Ministry of Industrial Commission (MIC).

*Research and production efforts underwent a strategic change in 1988, after the Iran-Iraq war ended, when a commercial product line was introduced. Despite the strategic production change, Iraq always maintained the philosophy that a CBW program would persevere; in times of war facilities would be utilized for CBW production and in times of peace facilities would be converted to commercial entities with the ability to quickly revert.*

- Al Muthanna (previously Project 922) halted CW production focusing instead on R&D, purification and stability of CW agents during August 1988 to April 1990.
- The rationale for stopping the chemical weapons production was that the CW agents at Al Muthanna throughout the previous years were in the crude state, containing many impurities which affected the stability and consequently the storage ability of the agents.
- The need for CBW agent drastically subsided and resources begin to stagnate from the reduced production requirement.
- Personnel and facilities were redirected to formulate and produce commercial products such as lice shampoo and petroleum jelly.
- Al Muthanna, however, maintained its ability to conduct a vibrant CBW research, development and production program.

*In order to ensure self-reliance, minimize dependence upon foreign resources, and conceal a CBW program within a legitimate commercial entity, Director General Fa'iz in the mid-late 1980s began producing, purchasing, and utilizing off-site facilities. The facilities contained the next generation equipment and were research capable.*

- Dependence upon foreign suppliers for precursors made the CW program vulnerable. Self-reliance for precursor production became a priority.

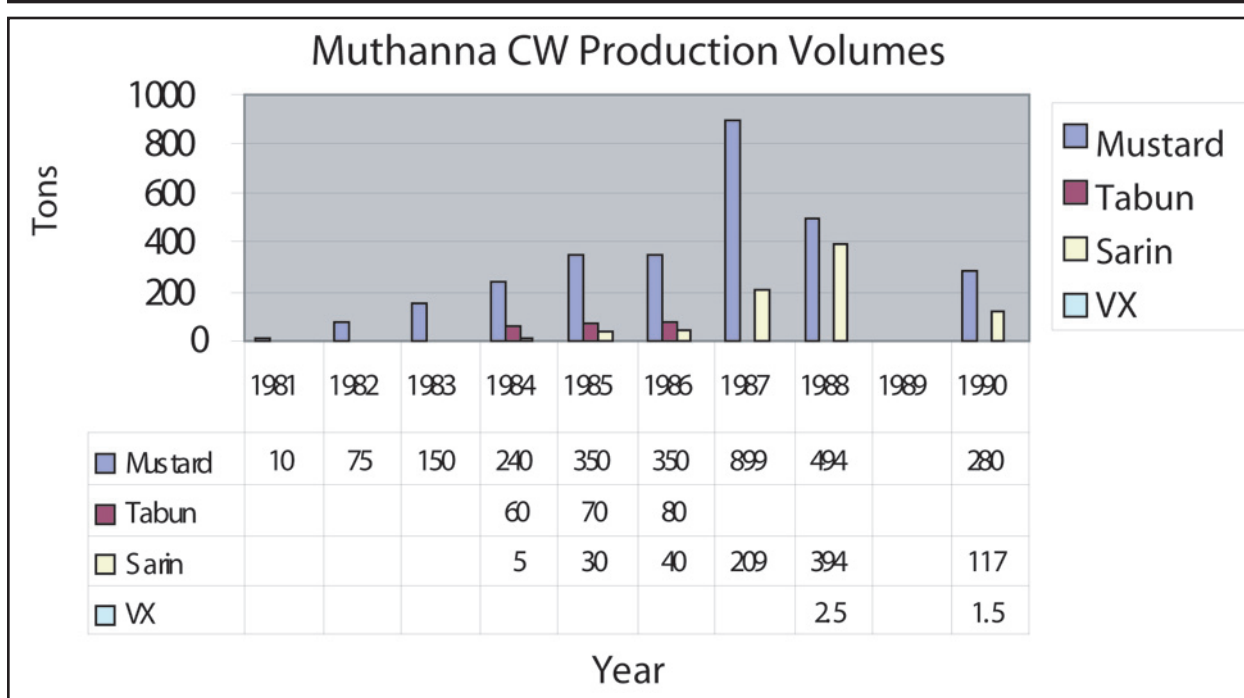


**Figure 1.** Al Muthanna Chemical Weapons Complex.

The BW program trailed the CW program, but gained momentum in 1985 by a compelling proposal submitted by Professor Nasser Al Hindawi. A microbiologist, Dr Rihab Rashid Taha, was recruited to lead the new BW program for Project 922. Research started at Al Muthanna but 1987 was transferred to Salman Pak.

- **The State Organization for Technical Industrialization recommended Dr Rihab Rashid Taha Al ‘Azzawi be recruited to pursue the establishment of BW program.**

- **In 1985 a laboratory was utilized at Al Muthanna and staffed with scientists to develop Bacillus anthracis, the causative agent of anthrax, and botulinum toxin.**
- **In May 1987 the BW program was transferred to Salman Pak. There was a leadership change at Al Muthanna and new management under General Shahin believed the BW work interfered with CW precipitating the location change.**
- **The BW program remained under Al Muthanna State Establishment control.**



**Table 1.** Project 922, declared production volumes of CW agents.

- Certain CBW projects at Al Muthanna were compartmentalized and relocated to other locations. Al Muthanna began acquiring commercial chemical, biological and pharmaceutical facilities to conceal the CBW program within analogous commercial enterprises:
  - ‘Aqarqf Laboratory
  - Fallujah I, II, and III (also known as Habbaniyah III, II, and I) to coalition forces.
  - The Serum and Vaccine Institute (SVI) at Al ‘Amiriyah.
  - Samarra’ Drug Industries.

*As early as April 1990, under fear of hostilities from Israel, resources at Al Muthanna were focused to operate at full CW production capacity. The Iraqi invasion of Kuwait in the same year precipitated an international reprisal. A US-led bombing campaign*

*quickly ensued and disabled Al Muthanna’s production ability.* After the bombings, reestablishing late Iran-Iraq war production rates proved difficult and dangerous. Al Muthanna was not able to recreate Iran-Iraq war CBW inventories.

- In 1990 Al Muthanna produced 1/3 its maximum annual production volume for mustard, 1/3 its maximum annual production volume for Sarin and 2/3 its maximum annual production volume for VX. See Table 1 Project 922 Declared Production Volumes of CW Agents in this section for CW agent volumes.
- On 02 April 1990 Saddam announced that Iraq possessed binary agents similar to the US and former Soviet Union and threatened to use them on Israel if the Israelis attacked Iraq with nuclear weapons.

- Al Muthanna began preparation, in late April 1990, for filling Al Husayn warheads with Sarin and its mixtures and switched to producing the binary by August 1990.
- Production efforts intensified after August 1990.
- An order was issued by MIC in late 1990 to evacuate all Al Muthanna State Establishment documents. To implement this requirement, most of the documents were transferred to air-raid shelters within MSE.
- Al Muthanna essentially ceased production in December of 1990 and refocused resources on dispersing CW stockpiles and equipment for protection against the anticipated bombing campaigns, which started in January 1991.

#### **Al Muthanna Chemical Weapons Production Facility Before and After Desert Storm**

*Al Muthanna's ability to produce chemical weapons ended with the Gulf war, and soon afterwards the UN resolution proscribed Iraq's ability to produce chemical weapons. The Fallujah satellite facilities (damaged during the Gulf war and not destroyed by UNSCOM), were repaired with the exception of Fallujah I which was not operational and operated as dual-use capable facilities. The majority of the Al Muthanna complex was bombed during Desert Storm, completely incapacitating Iraq's chemical weapon production capabilities, however, large stockpiles of chemical weapons and bulk agent survived.*

Laboratories and production areas are shown below after the Gulf war bombing. Facilities boxed are annotated. The facilities not boxed in the enclosure are Iraqi decoys (see Figure 2).

*After the bombing during Desert Storm, the roofs on the research facilities collapsed incapacitating research capabilities at Al Muthanna. The animal house was left.*

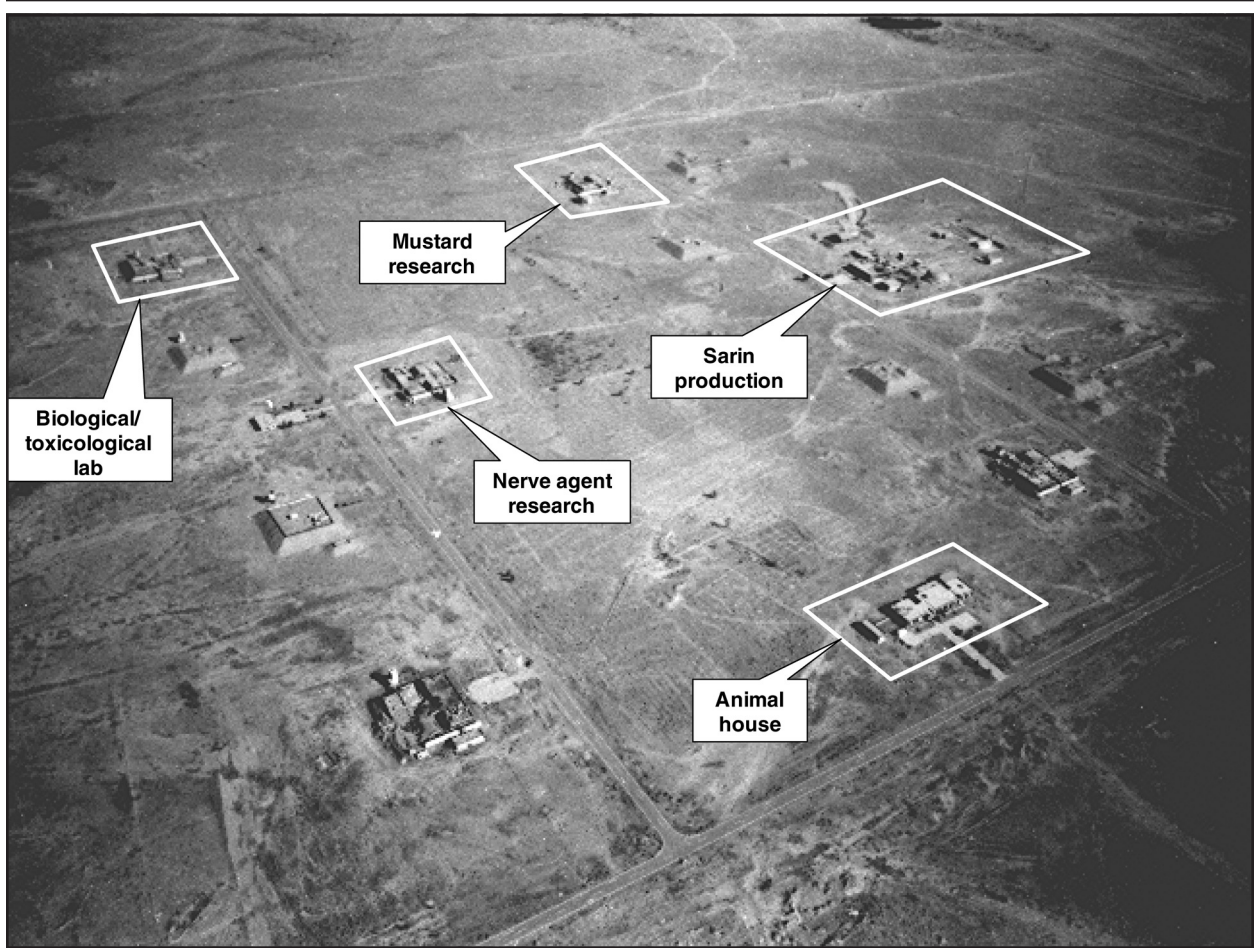
*During Desert Storm, the bomb assembly area was destroyed.* The engineering support area and Chemical and Material Storage area experienced some collateral damage. Chemical and Material Storage Area where CW precursors were stored at the end of February 1991 were not bombed but experienced collateral damage as a result of the bombing.

*The precursor and agent production area at Al Muthanna was not completely destroyed during Desert Storm. Portions of the mustard (blister agent) production and storage area survived. The VX and Tabun production (nerve agent) facilities were incapacitated.* Decoy facilities that had been built on the complex remained intact (see Figure 3 for complete annotation).

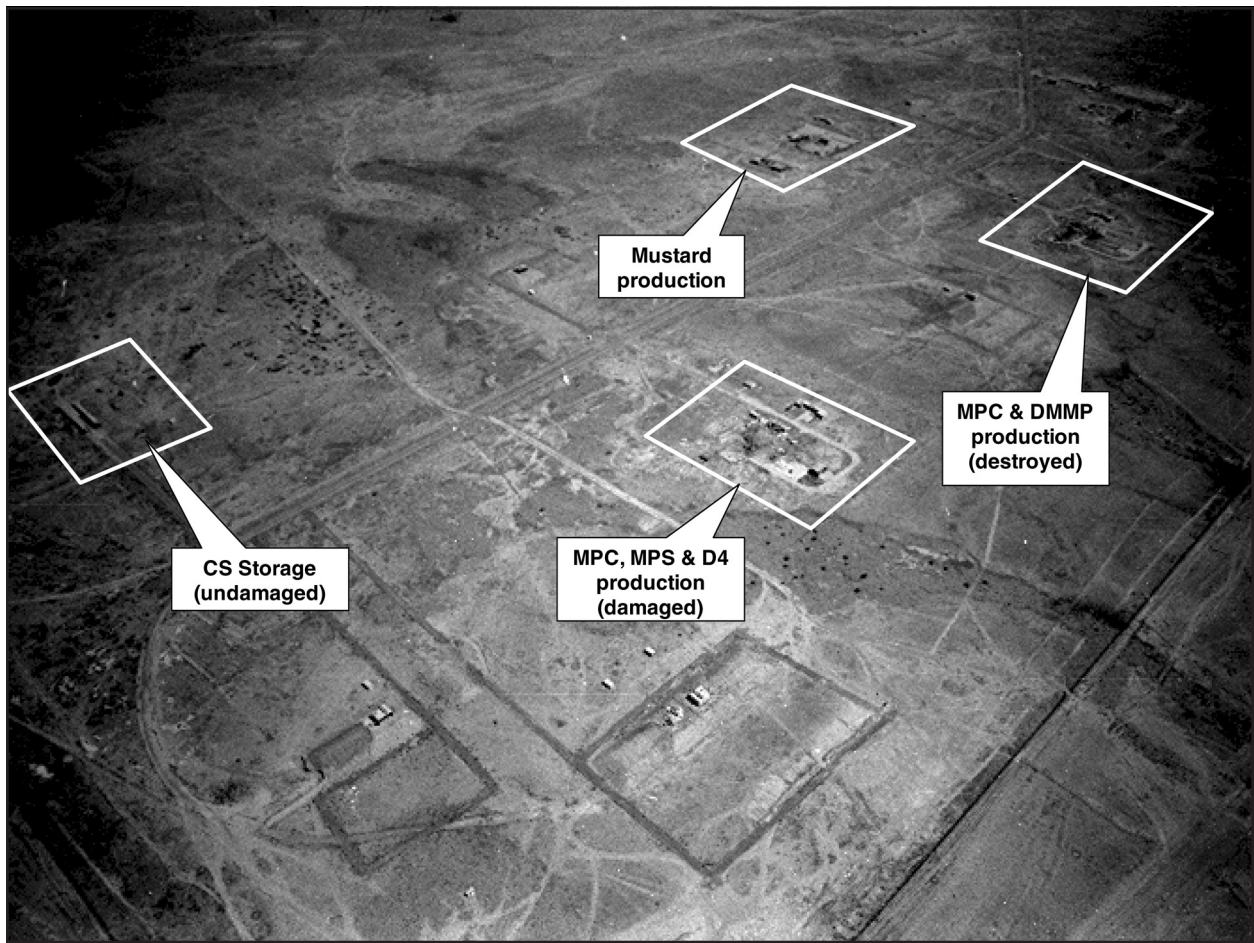
*The pilot plants survived much of the bombing during Desert Storm. Several structures remained intact, including the Inhalation Chamber, Quality Control Lab and two production areas. The Sarin production area was struck but not destroyed.*

- Pilot Plants included three main production areas; Pilot Plant No.1 produced DMMP and D4, Pilot Plant No.2 produced DMMP and MPC, Pilot Plant No.3 produced DMMP, methyl phosphonyldifluoride (MPF) and Sarin.
- In the northeast portion of this area of the plant was a quality control laboratory. The laboratory was not struck during Desert Storm.
- Located in this section of the plant was an Inhalation Chamber. A guard post and barracks—both non-production related—were located at the northern section of this area. Neither facility were struck during Desert Storm (see Figure 4).
- The weapons assembly area where agent was loaded into munitions was located approximately 3 kilometers southeast of the overall facility. The remoteness of the location was chosen by the Iraqis to avoid unnecessary casualties in the event of a mishap during the uploading process.

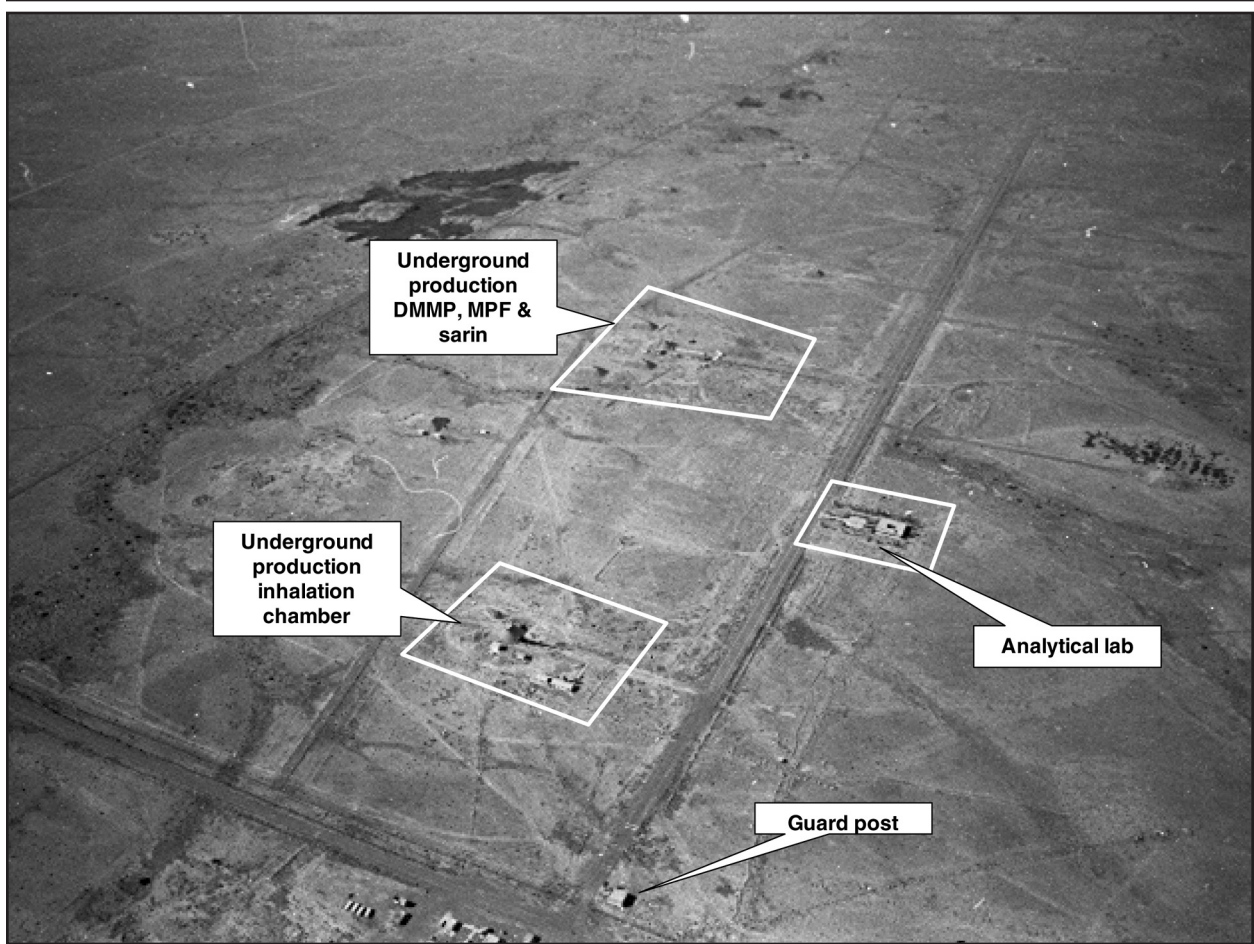




*Figure 2. Al Muthanna R&D/Laboratory area after Desert Storm.*



*Figure 3. Al Muthanna precursor and agent production area after Desert Storm.*



*Figure 4. Al Muthanna pilot plants and storage area after Desert Storm.*

- There is also a shampoo filling area located on the northeast section of this portion of the facility.

The Munitions Filling area suffered serious damage during Desert Storm. The entire operation was completely disabled except for two structures that were part of the Shampoo Filling Station at the northeast end of the complex.

Cruciform bunkers after Desert Storm are shown Figure 5. The overall facility contained more than 30 bunkers and hardened facilities. The CW bunker storage area consisted of eight large, earth-covered cruciform bunkers and six dummy cruciform bunkers. Gulf war bombing completely destroyed one bunker because of secondary explosion and severely damaged two others.

#### **Al Muthanna State Establishment Post-Gulf War**

From 1992 to 1994, UNSCOM's Chemical Destruction Group (CDG) oversaw destruction operations. A portion of the facility was transformed into a CW agent destruction facility. An incinerator was constructed in the summer of 1992 for the destruction of mustard agent at the munitions filling location. Chemical munitions stored throughout Iraq were to be gathered and destroyed at Al Muthanna. See Figure 6 for the location (note image was taken after incinerator was dismantled).

- Between 1992 and 1994 the facility was the primary collection and destruction site for all declared CW agents, precursor chemicals, and chemical production equipment.
- Between 1992 and 1994 and again in 1996, the CDG oversaw destruction of 30,000 pieces of ordnance, 480,000 liters of chemical agents, and more than 2 million liters of chemical precursors. Eventually, most of the facilities at the complex the Iraqi's destroyed and sold for scrap.
- Equipment that survived Desert Storm was tagged by UN or destroyed, but the UN was never able to verify that all equipment purchased for MSE was tagged or destroyed.

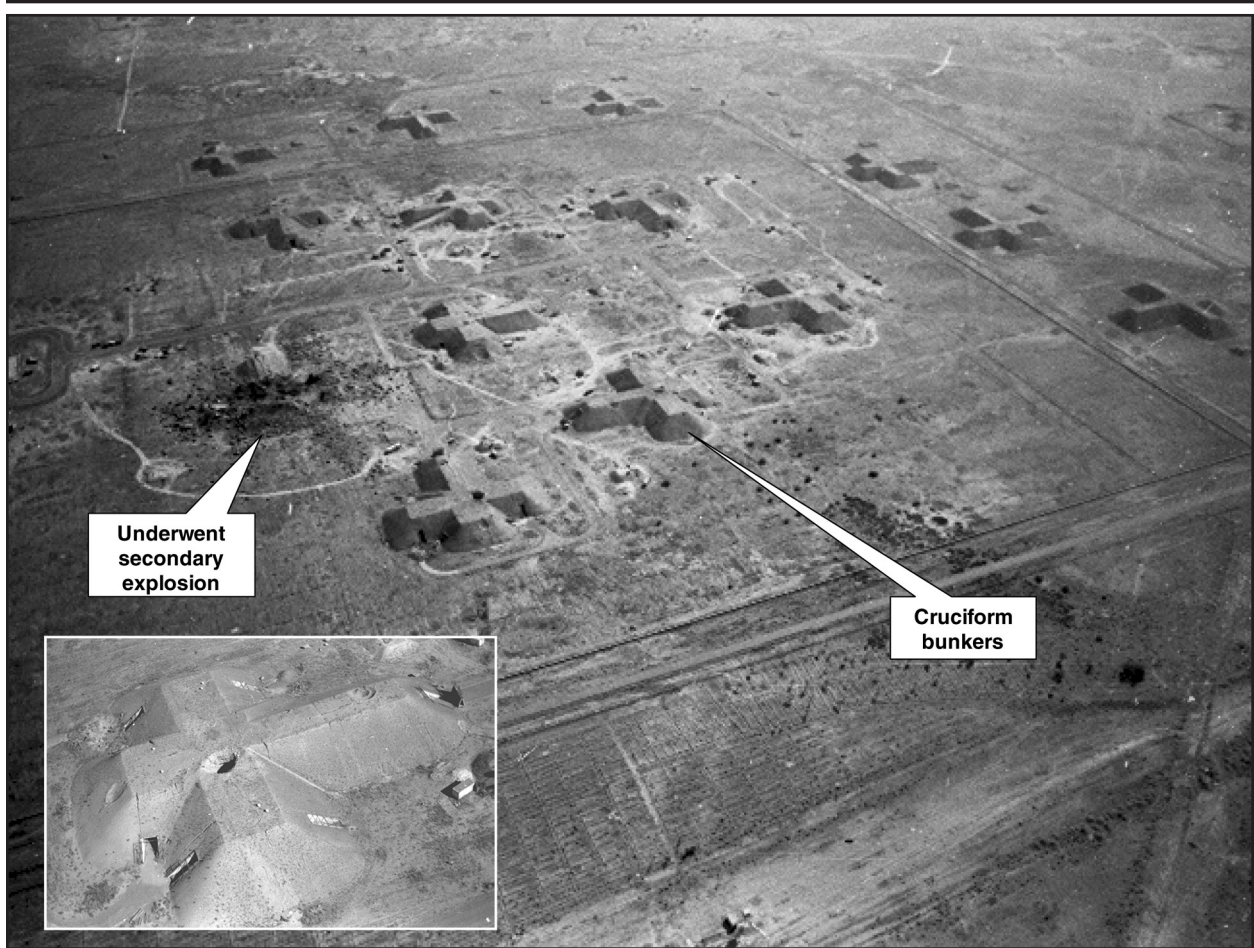
- Two Cruciform Bunkers were sealed containing munitions too dangerous for destruction.

- Bunkers, damaged by coalition bombing, collapsed, concealing unaccounted CW equipment and munitions in the debris. Over the next ten years some of the facilities were razed by the Iraqis. Precise accountability of equipment and munitions is unverifiable, because the National Monitoring Directorate and UNSCOM did not always oversee excavation.

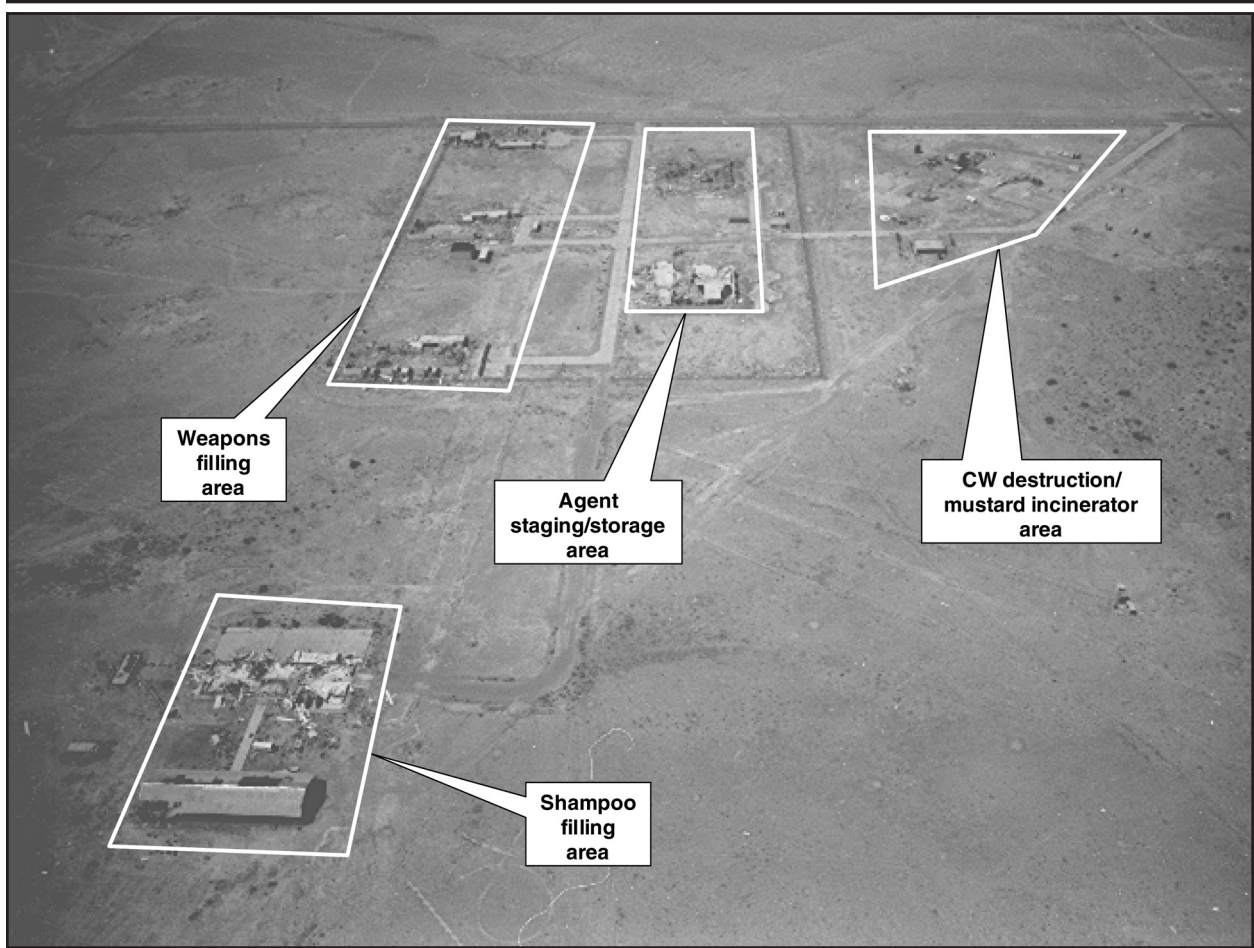
*After 1994, CW production related activities ceased at the Primary Al Muthanna site that once was Project 922 (Samarra' Chemical Weapons Production and Storage Complex). A small security detail remained. Two sealed cruciform bunkers containing the largest declared stockpile of chemical munitions, old bulk chemical agent, and hazardous material associated with the CW program remained. The surrounding area at the facility became a refuse area or junkyard for relics of Iraq's past CW weapons program.*

- Two damaged cruciform bunkers were used to seal damaged chemical munitions, residual chemical agents, and hazardous material.
- The contents of the bunkers were declared to the UN but never fully. The munitions inside the bunkers were damaged from ODS bombings; fires, leaking munitions and physical damage to munitions made the environment inside the bunker extremely dangerous.
- The National Monitoring Directorate and a small security detail monitored the bunkers.

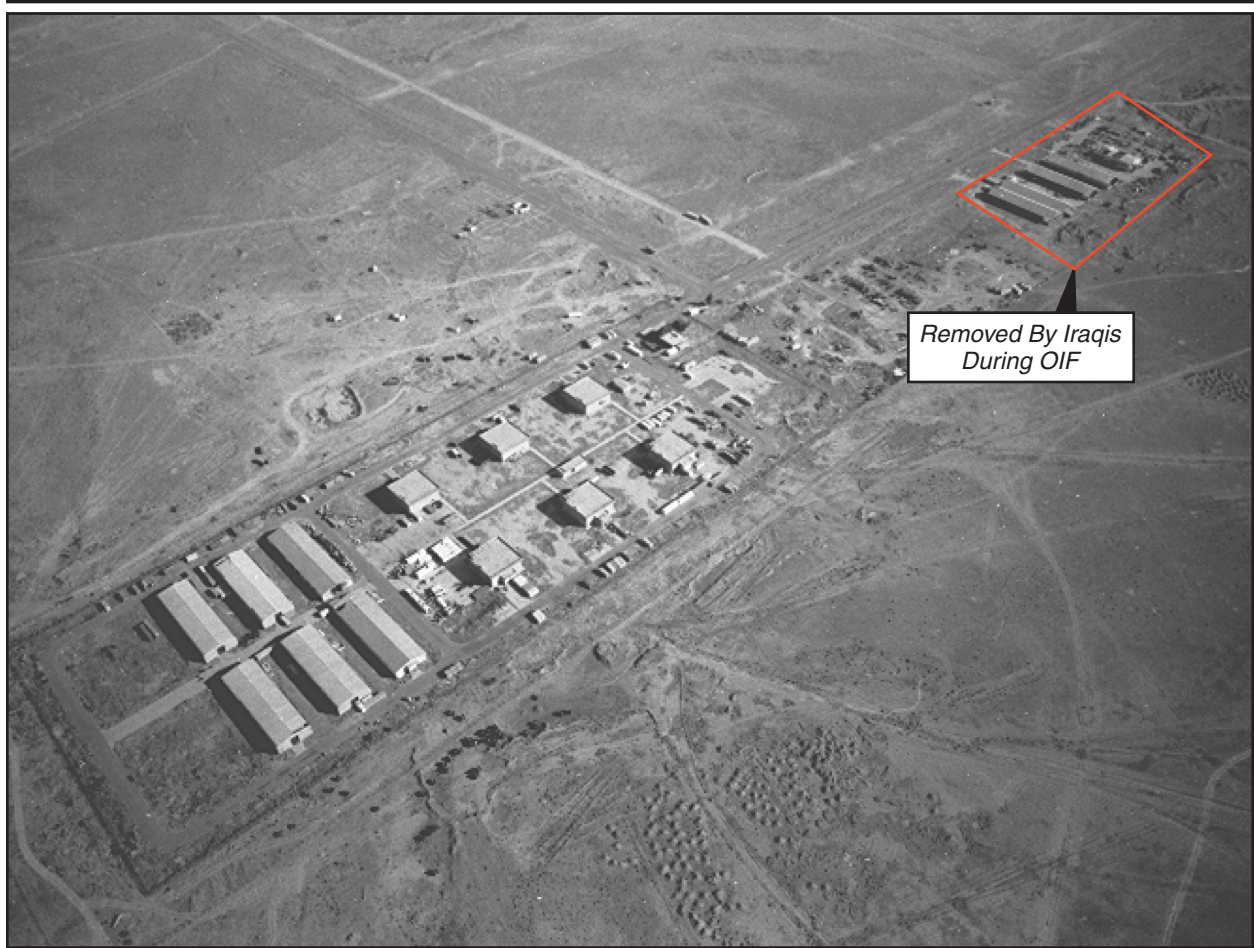
*Between 1994 and OIF, Iraq requested UN approval to remove and relocate some of the equipment and facilities. Imagery analysis revealed in early 1997 that the Iraqis excavated many of the research and production buildings. Iraq had razed most of the Al Muthanna Complex by early 2000, leaving only the southern part of the former chemical and material storage area intact (see Figure 7).*



**Figure 5.** Munitions storage area.



**Figure 6.** Destroyed CW agent filling area.



**Figure 7.** Al Muthanna chemical and material storage area after OIF.

---

### ***UN Criteria for CW Destruction***

*During the UNSCOM-supervised destruction processes, a CW facility was technically considered destroyed under three different criteria:*

- *Equipment was permanently disabled by the Iraqis, then examined and documented by UN.*
- *Equipment would be tagged, dismantled, and reused by the Iraqis for other legitimate commercial use while being documented and monitored by UN.*
- *Facilities destroyed from coalition strikes were deemed unusable for CW development.*

*Note: UN did not verify reusability of some of the equipment concealed within rubble of destroyed facilities. The CW process that once occurred within a bombed facility was regarded as inoperable, but utility of equipment reusability sometimes remained unverifiable.*

---

- Prior to OIF, Iraq removed buildings and their contents from the northern section of the Chemical Precursor storage area. The facilities at the southern section of the facility were removed by unknown entities between April and June of 2003.
- Between 2002 and OIF the Iraqis removed some of the facilities/warehouses (photo above). This activity was probably not WMD related.

The majority of the facilities—including the laboratory area, pilot plant, production area, bomb product, and engineering support weapons filling area—had been excavated prior to OIF.

Figure 8 shows the Administration Area razed before OIF. One structure remained intact after 1994; the remaining administration buildings were removed after 1994.

Figure 9 is the laboratory area. It had been excavated and razed by the Iraqis after 1990 and prior to OIF. The only facilities not razed by the Iraqis were the animal storage area (not bombed during ODS).

***The Iraqis razed and removed all existing structures for the biological/toxicological lab, mustard research lab, and Sarin production facility. In addition to complete removal of the facilities, complete foundations were excavated and removed. These actions were undertaken after the National Monitoring Directorate was displaced in Iraq and completed without international scrutiny.***

***The Tabun Production Facility was razed in a similar fashion to the other nerve agent production facilities in that all remnants of the existing facility were removed to include foundations and surrounding top layers of soil. Portions of the VX Production Facility were filled with sand. The facility was not razed by the Iraqis, however all equipment were removed (see Figure 10).***

Figure 11 shows the pilot plant area had been sealed after ODS. This was a hardened facility area, and the QC lab and Inhalation facility were still intact. The Sarin Production Facility that was bombed was excavated and the non-hardened facilities in the area were razed.

***Al Muthanna undergoes a series of name changes and ultimately becomes the Al Tariq Company. After 1994 MSE (Samarra' Chemical Weapons Production and Storage Facility as well as its satellite facilities) underwent strategic changes in key researchers and production. Resources were spent trying to rebuild the satellite facilities; however, the site Al Muthanna (Samarra' Chemical Weapons Production and Storage Facility) remained essentially abandoned.***

- Key leadership at the facility sought alternative employment.
- The bulk of the technicians and certain key scientists were employed within the Al Tariq State Establishment.
- Several key figures are employed by, or consultants to NMD.
- The Director General of Al Muthanna assumed a leadership position within Al Tariq.





**Figure 8.** Al Muthanna administration support area razed after 1994.



**Figure 9.** Al Muthanna research laboratory area.



**Figure 10.** Complete excavation and removal of the Tabun production facility (left) and the sand-filled sarin production facility (right).



**Figure 11.** Al Muthanna nerve agent lab (left) and quality-control lab (right).

## Exploitations of Al Muthanna

*ISG conducted multiple exploitations of the Al Muthanna site to determine whether old chemical weapons, equipment, or toxic chemicals had been looted or tampered with since the last UN visit to the site. ISG is unable to unambiguously determine the complete fate of old munitions, materials, and chemicals produced and stored there. The matter is further complicated by the looting and razing done by the Iraqis.*

*An exploitation of the facility reconfirmed previous imagery analysis that the site remained inoperable from bombings and UNSCOM compliance, including destruction of equipment and resources, and no significant production capabilities existed. Facilities and bunkers revealed no evidence of production since UNSCOM departed.*

- The teams found no new structures or any construction activities except for those declared by Iraq to UNSCOM. The facilities appeared to be abandoned prior to OIF.
- Several pieces of equipment that were once used for CW production were found bearing no UN tags, and the ISG was unable to assess whether the equipment had been reused since 1994 or intended for a future production processes and abandoned.
- The tag system used by the UN was known to not be robust, and given the absence of inspectors between 1998 and 2002, Iraq would have had little incentive to maintain the tags in good condition.
- The extent of the looting and unaccounted for excavations of bombed facilities makes it impossible to determine what, if any, equipment was removed after 1994, either for legitimate industrial use or a renovated CW production process.
- ISG exploitations indicate that the storage area still remains a threat despite testing. Chemical storage containers filled with unknown hazardous chemicals are showing signs of rusting-through and leaking.
- Key bunkers and facilities are currently scheduled to be sealed or resealed.

*Stockpiles of chemical munitions are still stored there. The most dangerous ones have been declared to the UN and are sealed in bunkers. Although declared, the bunkers contents have yet to be confirmed. These areas of the compound pose a hazard to civilians and potential blackmarketers.*

- Numerous bunkers, including eleven cruciform shaped bunkers were exploited. Some of the bunkers were empty. Some of the bunkers contained large quantities of unfilled chemical munitions, conventional munitions, one-ton shipping containers, old disabled production equipment (presumed disabled under UNSCOM supervision), and other hazardous industrial chemicals. The bunkers were dual-use in storing both conventional and chemical munitions. Figure 12 is a typical side-view of a cruciform shaped bunker.
- The contents of two of the cruciform bunkers bombed during Desert Storm showed severe damage. Due to the hazards associated with this location, the UN decided to seal the bunkers.
- UNSCOM viewed the contents of the two bunkers; however an accurate inventory was not possible due to the hazards associated with that environment.
- UNSCOM relied upon Iraqi accountability of the bunkers' contents and assessed the amount of munitions declared to be realistic.
- Military field testing equipment showed positive for possible CW agent in the cruciform bunkers that contained munitions and a storage bunker that contained bulk chemical storage containers. Note: this is not unusual given the munitions once stored there and the conditions in which they were stored post 1994.

*An exploitation team observed the old UNSCOM CW destruction area that contained large (some in excess of 75 meter) sloping trenches once used in the CW destruction process. Damaged chemical storage drums were visible at the bottom of some of the trenches.*

- Drums and debris were visually observed in two of the 12 burial trenches. The other 10 trenches appeared to be partially filled, no drums or debris was visually observed and they did not register positive for chemical agent. The two that contained exposed 55-gallon drums and various metal debris did not register positive from CW. These were remnants of the incinerating pits and should have been covered.
- Bunkers tested positive for chemical agents and confirmed observations (bunkers contained large quantities of unfilled chemical munitions, conventional munitions, one ton shipping containers, old disabled production equipment (presumed disabled under UNSCOM supervision), and other hazardous industrial chemicals). Also noted were hundreds of rusted bulk storage containers that once contained bulk mustard agent. Despite the presence of these chemical storage drums field testing concluded no CW agents were present.
- The hardened laboratories/pilot plant and animal compound were sealed prior to OIF and were breached, presumably by looters. Sampling of both areas showed no evidence or presence of chemical agents and the facilities were incapable of producing chemical munitions.

***All the facilities (laboratories, pilot plant, bunkers, and animal storage area) inspected that were supposed to be sealed as a result of UN resolutions had been breached. Exploitation of these facilities revealed materials and equipment were removed, however the extent of looting makes it difficult to differentiate whether Iraqi government removed equipment after 1998 while still under UN sanction or if it was looted after OIF.***

- Locks on metal doors were cut or concrete and bricks were breached producing apertures large enough for human entry.
- Figure 13 shows that bricked entryways were breached. The debris in the corridor in the photo to the right apparently is from removed material inside the bunker. ***Massive amounts of cylinders that once stored chemical agents, primarily bulk mustard agent, now are stacked in huge bunkers.***

***This practice was consistent with Iraq's destruction program involving the removal and incineration of agent and equipment.***

- Hundreds of bulk storage cylinders were preserved from the destruction processes that took place in the early 1990s. They once contained chemical agents that were supposed to be destroyed. The remaining cylinders contained residual material that was to be neutralized by adding caustic and water. Some residual or leaking caustic, now dried, is apparent from the white residue on the side of a cylinder in Figure 14 (residue not sampled). This is consistent with Iraq's destruction program involving the removal and incineration of agent and equipment.
- The team located a storage cylinder with the red and white plastic siphon (see Figure 14), and found it suspect. It was apparent that contents had been removed. Follow-on analysis of the drum revealed the drum was filled with petroleum products (presumably fuel oil). ISG assesses the fuel oil storage in the cylinders might be from residual oil once used in/for the mustard incinerator. Since the oil was associated with mustard destruction, it might have been regarded as hazardous material and thereby not discarded into the environment. Instead it was placed into the contaminated storage cylinders and stored in the bunker with the rest of the contaminated cylinders.

ISG also exploited the underground pilot plants, which also had been breached by looters, and found a reactor unit that was suspect.

- The reactor should have been destroyed as part of UNSCOM inspections. The plant infrastructure required to operate the reactor was missing rendering it inoperable.
- The reactor is made from a recycled two-ton bulk mustard storage cylinder, similar to the ones viewed in the storage bunker above (see Figure 15).

***The team found the laboratory, production, and animal house area looted and inoperable. Again, equipment that should have been destroyed by the UN was found here.***



**Figure 12.** Typical side view of a cruciform shaped bunker.



**Figure 13.** Bricked entryways that were breached.



**Figure 14.** Storage cylinder with the red and white plastic siphon.



**Figure 15.** Reactor made from recycled two-ton bulk mustard storage cylinder.

- Cages that once housed animals were strewn about the site. Some of the cages appear to have held dogs used to study the efficacy of CBW agent, and others were designed to hold primates based on the size and bar spacing on the cages despite intelligence that Iraq never conducted research on primates. Scratch marks also were on the wall apparently from animals, probably primates.
- An inhalation chamber was located at the site. Although it did not appear designed for humans, it was large enough to accommodate a human. Instead, the chamber apparently held cages which were inserted for animal experiments (see Figure 16). Note: there was no evidence recovered to indicate that humans were used in the experiments. This equipment should have been destroyed and verified by UNSCOM.

***The team found multiple glass-lined reaction chambers, remnants from the former CBW programs, some which were UN-tagged and others which did not bear tags. Inconsistencies in the destruction methods among reactors might allow for cannibalization of parts to produce other reactors.*** The most interesting find is the reactor shown in Figure 17, which not only was devoid of a UN tag, but the glass-liner was still pristine with only minor chips.

- The reactor liner probably was chipped by looters when attempting to move the reactor without the proper equipment. More importantly, there is no indication of where the reactor originated and where it has been since the departure of the UN.

As a general note, there are a number of possible reasons for equipment bearing no UN tags:

- Equipment was destroyed in Desert Storm and therefore was not tagged;
- Equipment was destroyed by UNSCOM and was tagged, but the tag was removed;
- Equipment was tagged, and possibly moved to other facilities for use as a dual-use item;
- Equipment survived bombing during Desert Storm, but was buried by rubble and subsequently not

tagged or destroyed by UNSCOM. Over the years, it may have been excavated by the Iraqis after UNSCOM left, or by looters after OIF.

It was apparent that some of the reactors were delivered to the facility for destruction while others were indigenous to the facility and destroyed on site.

***A refuse area was exploited containing hundreds of empty munitions intended for chemical or biological agent filling.*** Warheads and peripheral hardware for brass and recyclable metals are still being looted. Old hardware destroyed under the auspice of the UN agreement and thousands of pieces of chemical weapons hardware that did not meet quality controls lay waste in the refuse area (see Figure 18).

- Hundreds of mangled and rusted munition bodies and tail sections lay strewn about (see Figure 18, upper left photo).
- Chemical bombs destroyed probably early 1990s (see Figure 18, upper right).
- Chemical rounds (observed were defective warheads) empty of chemical agents (see Figure 18, lower left photo).
- Chemical rounds (without agent) after explosive agent had been removed by a scavenger in order to recover brass components (see Figure 18, lower right photo).

***The ISG found hundreds of canisters—both polymer and metal foil inserts—for chemical agents used as insert for munitions lying on the ground.***

Two pictures Figure 19 show the difference—on the left, the metal SAKR-30 canister, and the right, a polymeric canister that fits inside the SAKR-30 canister. There is no picture of the sister canister that connects to form the body of the warhead.

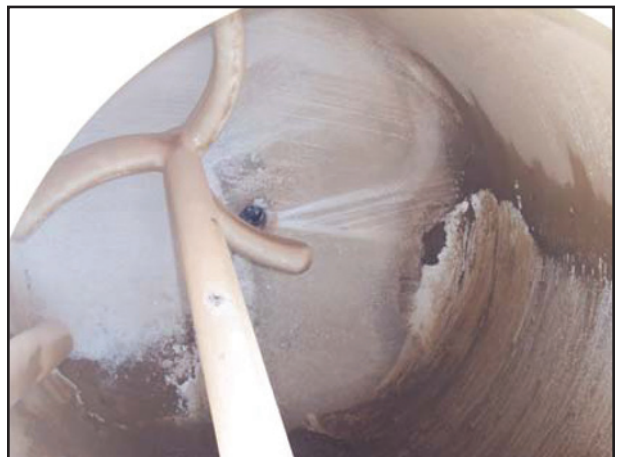
***The team noted several sloping trenches near the site which we believe were once used in the destruction process of CW rockets. Note: some of the trenches appear to be arranged for a specific process while some contained brick structures within the***



*Figure 16. An inhalation chamber.*



*Figure 17. Glass-lined reactor.*







**Figure 18.** Mangled and rusted munition bodies and tail sections (top left), chemical bombs destroyed probably early 1990s (top right), chemical rounds empty of chemical agent (lower left), and chemical round (without agent) after explosive agent had been removed by a scavenger.



**Figure 19.** Metal (left) and polymeric (right) chemical agent canister inserts for SAKR-30 munitions.



**Figure 20.** Sloping trenches with exposed drums and debris.



*base (see Figure 20).* Upon completion of destruction, other trenches were covered. It is uncertain if portions of the trenches were unearthed by looters or were not originally filled.

- Two of the trenches contained some drums that were exposed and rusted. Sampling of the damaged drums and surrounding standing water showed no presence of CW agents.
- The picture above shows one of the deeper sloping trenches with exposed drums and debris. A multitude of bird droppings coated the area where birds had taken refuge in the sandy walls of the trenches.

*The entire Al Muthanna mega-facility was the bastion of Iraqi's chemical weapons development program. During its peak in the late 1980s to early 1990s, it amassed mega-bunkers full of chemical munitions, and provided Iraq with a force multiplier*

*sufficient to counteract Iran's superior military numbers. Two wars, sanctions and UNSCOM oversight reduced Iraqi's premier production facility to a stockpile of old damaged and contaminated chemical munitions(sealed in bunkers), a wasteland full of destroyed chemical munitions, razed structures, and unusable war-ravaged facilities. In 1998 Al Tariq State Establishment took over all remaining remnants at Al Muthanna.*

## Annex C The Iraqi Industrial Committee

*Saddam personally ordered the creation of the Iraqi Industrial Committee (IIC) in September 1995 to coordinate activities of the Iraqi industrial sector, according to documentary and other reporting. The IIC probably never developed formalized procedures for coordinating industrial efforts and its overall strategy and mechanisms for project implementation probably were somewhat nebulous even to its own participants. Looting, vandalism and destruction of documentation have complicated ISG efforts to fully understand the role of the IIC and its subordinate projects.* A complex, interdependent web of constantly evolving committees, projects and commissions was responsible for national research and development for indigenous production of chemicals, based on ISG analysis of documents and reporting.

- ISG has been unable to identify the policy direction for the IIC's operations and has obtained conflicting data about operational details.

### IIC Subcommittees and Their Responsibilities

#### **The Central Evaluation Research Committee/ Evaluation Research Committee**

In the first phase of projects, the Evaluation Research Committee evaluated the initial work carried out and reported to the Central Evaluation Research Committee, which in turn reported to the IIC. After all preliminary research had been reviewed, both the Evaluation Research Committee and the Central Evaluation Research Committee were disbanded and the research was passed to the Technology Transfer Committee, according to reporting.

#### **The Research and Development Committee/ Technology Transfer Committee and Its Subcommittees**

Dr. Ja'far chaired both the Research and Development Committee and the Technology Transfer Committee. The Research and Development Committee provided oversight for chemical research for the strategic

research program, according to documents and reporting, and was responsible for prioritizing projects based on economic benefit and feasibility, according to different reporting. Other committee members included Drs. Ahmad and Al Jabburi of the Ministry of Higher Education, Dr. Karim of Al Razi Center, Dr. Al Qurashi of the Iraqi Atomic Energy Commission (IAEC), Drs. Naji and 'Atto of the Chemistry Department at Saddam University, Dr. Asawa of the Ministry of Industry, Dr. Rathman from the Ministry of Industry and Minerals (MIM) and Drs. Hashim and Hamzah Yasin of the Military Industrialization Commission (MIC), according to multiple reports.

The Technology Transfer Committee, established in 1996, was responsible for researching and acquiring strategic technologies from outside Iraq. This committee tracked foreign technological developments by targeting students, attending trade shows and sponsoring educational exchanges, according to reporting. Different reporting indicated the Technology Transfer Committee was responsible for the coordination of all medical and agricultural research in Iraq. The Technology Transfer Committee appeared to share or subsume the responsibilities of the Research and Development Committee probably because Dr. Ja'far chaired both.

#### **The Follow-Up Committee for Pharmaceutical Research**

This subcommittee was responsible for reviewing research reports, evaluating scale-up feasibility, and evaluating quality control testing of samples. It reported directly to Dr. Ja'far at the Office of the Presidential Advisor. Once the committee approved the research results, the organization received full payment for the work, according to Dr. Ja'far.

#### **The Distinguished Industrialists Council**

This body formed in February 2001 after 18 prominent Iraqi industrialists met Saddam Husayn. The IIC was tasked to carry out several joint activities with this group of industrialists, including the setting up of a study to provide the correct requirements to the industrialists, based on documents recovered by ISG.

### **The Chemical Industries Committee**

This was a joint MIC-MIM oversight group under the IIC established to implement the National Project for Pharmaceuticals and Pesticides, according to reporting.

### **The National Project for Pharmaceuticals and Pesticides (NPPP)**

*The NPPP was established in early 1999 in response to a written order from Saddam, who took personal interest in the program's progress.* Three types of commercial products were targeted for indigenous production under the NPPP.

- Drugs/pharmaceutical/chemicals
- Pesticide chemicals
- Materials for medical diagnostic kits

According to a former high-ranking employee at Ministry of Higher Education and Scientific Research (MHESR), which was the primary organization responsible for the research, the national drug program consisted of six categories of research focus—medicines, primitive chemicals, active ingredients, kits, pesticides and veterinary medicines. Two categories of required chemical research for the above products were identified.

- Synthesis of active chemicals required for making finished pharmaceutical products and pesticides (“active chemicals” probably refers to biologically active substances).
- R&D on formulation technologies required to produce final drug products. Research on such technologies would focus on formulating products for which Iraq already had the ingredients.

*The National Project for Active Chemical Materials probably began in 1999 under the NPPP on the recommendation of the Minister of Higher Education and Scientific Research, Humam ‘Abd-al-Khaliq ‘Abd-al-Ghafur.* Humam proposed the project to Saddam in a letter in which he indicated that he had many skilled chemists with little to do, according to

reporting. Humam reported substances were placed on the list based on the need of the Ministry of Health (MOH) and the Ministry of Agriculture.

*Ministries and companies from across Iraq’s pharmaceutical and pesticide sectors initially nominated chemicals and materials that Iraq needed for research and development and eventual pilot production under the NPPP.* According to a former high-ranking employee of MHESR, the chemicals were needed because Iraq could not obtain them under sanctions after 1996. However, few of the hundreds of chemicals identified were restricted by sanctions.

*The IIC, in consultation with technical experts from MIC, MOH, and MIM, evaluated these recommendations.* MIM had primary responsibility for identifying priority “active” pharmaceutical chemicals, while MOH advised on final pharmaceutical products to be included on the list and MIC was responsible for evaluating pesticide-related chemicals for the list.

*The IIC’s Program for the Indigenous Production of Chemicals probably was more of a boon to Iraqi science than most regime programs, because the program implemented some merit-based competition and methodical science.* According to reporting, the work stimulated by the IIC’s Technology Transfer Committee was scientifically credible and was selected on merit.

- The Technology Transfer Committee headed by Dr. Ja’far was involved in promoting research by the private sector and in Universities. The Committee stimulated work which lead to additional areas of research activity, according to the same reporting.

In contrast, other regime programs promoting individual scientific achievement probably were corrupted by special interest groups who stood to gain financially or personally for successfully lobbying chosen projects irrespective of scientific merit.

- If a knowledgeable person did not step in to put a halt to a scientifically invalid project, the project would proceed. After 1998, if a knowledgeable scientist objected to an unsound project that scientist was accused of being entrenched in the system, according to ‘Amir Hamudi Hasan Al Sa’adi.

---

***MIC and MIM: Key Players in Iraq's Chemical Infrastructure***

*The chief military trade organization—the Military Industrialization Commission (MIC)—and the principal ministry of civilian commerce—the Ministry of Industry and Minerals (MIM)—both had subordinate production facilities which made conventional weapons, equipment and materials for the military.*

- *Although the MIC and the MIM were separate ministries, they cooperated on military issues including equipment, spare parts, projects and vehicles. Dr. 'Imad Husayn 'Abdallah Al 'Ani, former VX expert, was the Director of the Office of Technical Cooperation, and was responsible for the cooperation and coordination between these two ministries and the Ministry of Defense as related to matters of supplying materials to the military, according to reporting.*
- *The Research and Development Office of MIM oversaw the Veterinary Center for the Formulation of Drugs for Animals, the Ibn-al-Baytar Center, the Chemicals Research and Development Center, the Ibn-Sina' Center and the Al Razi Center. The MIC's subsidiaries included the Al Majid Company, Al Basil Center, and the Al Raya Center.*

*The scientific capabilities of the MIC and the MIM were comparable and most chemical research could be tasked to either, although pharmaceutical work was typically assigned to MIM, while pesticides research and production was usually delegated by MIC, according to reporting.*

***Prior to OIF, MIM was under less international scrutiny than the MIC, the key organization through which WMD activities were funneled under Husayn Kamil.***

---

- Additionally, the special interest groups found ways to bypass the mechanisms intended to prevent unsound projects by suppressing bad results and evidence of failed tests, and by concurrently highlighting any experiment that was even partially successful.
- One example of a project with a poor scientific basis and no chance of success, according to Al Sa'adi, was a project to use lasers to disrupt weapon systems and computers of attacking aircraft. Although the experiments were conducted with a craft not used by any potential enemies, and only one of several tests was even partially successful, the project was considered a success and the system was ordered into unit production.

*This page intentionally left blank.*

## Annex D Tariq Company's Activities

*The Tariq Company, also referred to as the Tariq Facility and formerly the Tariq State Establishment, encompassed several facilities near Fallujah including a headquarters complex; Fallujah I, Fallujah II, and Fallujah III (also known as Habbaniyah III, II, and I); a research site in Baghdad referred to as the "Baghdad site"; and several storage locations. Tariq was subordinate to the former Muthanna State Establishment (MSE) chemical weapons (CW) research, production and storage facility near Samarra before it was destroyed. It has a long history of ties to Iraq's CW program, and throughout the 1990s continued to house key CW scientists and maintain basic capabilities to produce at least some CW precursor chemicals. Iraq renovated key processes and reinitiated production of basic chemicals in 2000.*

- Tariq chemical facilities were designed to be, and in the case of Fallujah II previously used as, CW precursor production plants.
- Fallujah II, while under previous state ownership, produced nerve agent and sulfur mustard precursors for MSE in the late 1980s.
- Tariq as of 2002 employed some of the more influential personalities associated with Iraq's former CW production programs.

*In an effort to determine the nature and extent of Tariq's activities after 1991, ISG conducted a series of site visits, interviews with key personnel, and document exploitation. Teams focused on evaluating activities of the two active Fallujah plants and questioning the former CW scientists, many of whom had held important positions in the former CW program, about their efforts at Tariq after the Gulf war.*

*Based on these investigations, ISG assesses that the Tariq Company did not provide Iraq with a breakout capability for nerve agent production.*

- **Pesticide (Formerly Fallujah III):** Instead of synthesizing precursors and pesticides on site and

in Iraq, Tariq imported concentrated commercial pesticides for formulation, repackaging, and local distribution.

- **Chlorine/Phenol Plant (Formerly Fallujah II):** Leading up to OIF, this plant was not fully operational, and was unlikely to have provided any basic chemicals such as chlorine or phenol to an Iraqi CW effort. Because of technical problems, the plant could not even supply local markets with its products.
- **One of Tariq's labs, the Baghdad Research Laboratory,** was closed at an unknown date, according to interviews with Huwaysh, and he stated its employees did not participate in any CW-related research while it was open. Other ISG interviews indicate that the lab may have engaged in defensive nerve agent detector research.

*As of 2001 or 2002, Tariq scientists were still regarded by members of the Regime as CW experts. When Saddam asked in 2001 or 2002 for an estimate of how long it would take to build a production line for CW, Huwaysh approached a team of Tariq scientists to answer the question, according to an ISG interview with Huwaysh.*

- Huwaysh's expert team included a number of Tariq employees, such as former directors Ghazi Faisal and Zuhair al-Qazzaz, according to the same interview.

We are considering the possibility that Huwaysh confused the details and actually was referring to a similar incident involving him that occurred in 1997. In the latter case, Huwaysh—not Saddam—reportedly initiated a query about how Iraq's CW capability would be limited by an UNSCOM-ordered destruction of dual-use equipment rather than how quickly production could be restarted.

---

### **Former CW Personnel Employed by Tariq**

*Tariq employed a large number of CW scientists and engineers from Muthanna State Establishment, especially within upper management of the company, throughout the 1990s and up to March 2003:*

- **Dr. Ghazi Faysal:** *Worked to build Tariq under the OMI after MSE was destroyed in the first Gulf war. Served as the director of Tariq until moving to al-Basel center.*
- **Dr. Iyad Muhammad Rashid Rauf:** *Deputy General Director for the Tariq facility. Iyad Rashid researched nerve agent production in the Salah ad Din Research Department of MSE.*
- **Husayn Shamki:** *Tariq research scientist.*
- **Ihsen Abd al-Amir:** *Tariq research scientist.*
- **Issam Daud Faysal:** *Formerly of the Al Karama Facility. Involved in quality control at MSE.*
- **Brig.Eng. Hayder Hassan Taha:** *Director of the Chlorine factory at Tariq; previously worked as a chemical engineer in the Project Directorate in Al-Muthana State Co.*
- **Staff Colonel Ra'd Manhal:** *Commercial and Planning director and NMD point of contact at Tariq, former director of the MSE munitions filling station.*

---

### **Dual-Use Facilities**

#### **Pesticide (Formerly Fallujah III)**

*Instead of synthesizing precursors and pesticides on site and in Iraq, Tariq imported concentrated commercial pesticides for formulation, repackaging, and local distribution.*

- ISG interviews of a senior scientist revealed that around 50 tons per year of the pesticide Nugoz was imported, sometimes using false customs declarations.

- A research scientist stated that while Tariq formulated a large list of commercial pesticides, the company did not produce pesticides at greater than laboratory scale, which he attributed to a lack of glass-lined equipment available in Tariq.

#### **Castor Oil Production (Formerly Fallujah III)**

*Castor oil was also produced at Tariq from 1992 until 2002, but ISG investigations did not uncover any indication that the ricin-containing mash was further processed or transferred off-site for any purpose.* According to interviews with Tariq officials, they complied with UNSCOM regulations by burning the residual castor bean mash in pits near the Fallujah III facility.

*Castor oil production ended in 2002 because of rising prices of castor beans and decreasing customer interest.* Two companies interested in purchasing Tariq's castor oil were Ibn Al-Baytar and Samarra Drug Industries, but ultimately neither company purchased Tariq's oil because its process used solvent extraction and rendered the oil unfit for pharmaceutical and medical uses, according to the same interviews.

- An ISG site visit indicated that the castor oil extraction plant appeared to be undamaged, but there was no evidence of any current activity. All of the surrounding buildings were empty, possibly because of looters.
- Tariq's castor bean supplier, the Company for Industrial Forests, had raised its prices from 60,000 to 400,000 Iraqi dinars per ton (from US \$38 to \$250) in 2002, and predicted that prices would increase to 700,000 dinars (\$438) the next year, according to the same interviews.

#### **Chlorine (Formerly Fallujah II)**

*Chlorine, a feedstock for some CW precursors, was produced at Tariq from 1993 to 1996, and sporadically thereafter; however, ISG has not discovered any information that indicates chlorine from the plant was diverted to a CW program.* During an ISG site visit, the director of the phenol plant stated that



chlorine production had stopped months before OIF. Reporting indicates the facility was unable to obtain membranes—the key component of the technology at Tariq—to separate the chlorine.

- Members of the site visit team noted that membranes, probably older, used ones, were stacked by the roadside close to the northwest entrance. The director stated that they had been moved here to protect them in the event that the plant was bombed.
- Chlorine from the plant was sold to local sanitation plants and also consumed onsite to produce other commercial water purification compounds such as sodium hypochlorite and calcium hypochlorite, which were sold for water treatment, according to the director.

***Technical difficulties with the process resulted in lower production outputs from 1996 until 2000.***

According to the director, the chlorine cells had been broken for several months and control valves, main instrumentation control panels and a step down transformer were missing.

***In 1999, the Indian firm NEC Engineers Private, Ltd., was recruited to begin repairing the chlorine production lines, according to multiple sources.***

The plant director during the interview said NEC constructed the membrane cell equipment that would be used to produce chlorine and caustic soda, but one of the membranes was second-hand and perforated easily, which caused further problems with the operation.

- Once the project was completed, operational training in India was scheduled for the plant engineers in, according to documents recovered by ISG.
- Tariq, along with MIC employees and a representative from Iraqi Intelligence, formed a committee to conceal imports from India's NEC engineers during a chlorine plant repair, according to documents recovered by ISG.

By March 2000, with help from the Indian firm NEC Engineers, the chlor-alkali plant was brought back on-line. On 02 July 2003, neither the chlorine nor the phenol plants at Fallujah II were in working order. With little likelihood of any production in the near future, few employees were at the facility.

**Phenol (Formerly Fallujah II)**

***Since its 1995 commissioning, UNSCOM was suspicious of the true nature of Tariq's phenol plant because of its proximity to Tariq's chlorine plant and a lack of details about modifications performed at the plant.*** As of OIF, the plant was no longer in operation, according to an ISG site visit and interviews with the director of the plant; the temperature control equipment was broken, as had been the case for some years, and was one of the reasons for the plant's low production levels.

- According to the plant director, the phenol had mostly been for al-Ramadi facility, where it was converted into a resin, used for making molds.
- ISG visited a resin facility north of Baghdad in March 2004, and observed that this large phenol consumer did not use indigenously produced phenol from the Tariq facility; rather, they imported phenol from South Africa, with UN permission.
- Additional processes at the phenol plant included a small azeotropic ethanol distillation unit, recovered from Al Muthanna. The purified ethanol was then sent to SDI and hospitals for pharmaceutical purposes, according to the director.
- In addition to a large list of industrial uses including resin and fiberglass production, phenol could also be used as a starting block for cyclohexanol, one component of cyclosarin, when reacted catalytically with chlorine. Cyclohexanol can also be synthesized from benzene, a much cheaper and more abundant chemical in Iraq, but we have no information that indicates Iraq used either process to produce cyclohexanol.

### Research Activities

*We assess the bulk of the Tariq's research throughout the 1990s—formulation and stability of pesticides—was legitimate and not CW related; however, a limited amount of defensive work with nerve agent simulants, and even gram-scale synthesis of agent may have occurred.*

- A research scientist reported that a typical formulation research project included evaluation of the following factors: literature research on pesticides; availability and ease of import of raw concentrated ingredient, emulsifiers, and stabilizers within Iraq; stability testing and physical properties testing of formulated product over time and temperature ranges; and field testing with 500 kg pilot-scale batches.
- The scientist confirmed to ISG that malathion, dichlorovos and 2,4-D amine, the amine salt of 2,4-D, had all been synthesized on a laboratory scale.

*Because of feared repercussions and the awareness of the dual-use nature of Tariq's products, officials at Tariq were often reported as hesitant to allow or support research that could be considered CW-applicable by the international community.*

- Ghazi Faisal had instructed the researchers to avoid synthesis of organophosphorus compounds as it might cause them difficulties with the UN, according to ISG interviews with Tariq scientists, and a senior scientist claimed he did not know of any synthesis of phosphorus based compounds.
- Huwaysh stated that he went out of his way to make sure that no CW research was going on, even to the point of canceling the Tariq research center in Baghdad.

*Tariq, in addition to its own research for industrial processes, also bid for and won research contracts from the IIC list of 1,000 chemicals, none of which were phosphorus-related.* Tariq's research and development department routinely reported the progress of these projects to Hamza Yassin, chief of chemical research and development at the OMI, according to reporting.

- Tariq researchers evaluated scale-up feasibility of the following industrial chemicals: benzyl alcohol, acetyl chloride, sodium hydroxide, aluminum hydroxide, ortho-chloroaniline, calcine, ferrous chloride, and mono-chloro acetic acid.

*Tariq scientists have also participated in CW defensive research, including the development of suitable nerve agent simulants for military training purposes and possible gram-scale production of VX standards for testing detectors and studying its degradation products.*

- A senior scientist, when asked about military equipment at Tariq, immediately mentioned a Russian-made detection system brought to the site by another senior scientist and used in simulant research.
- A research scientist described larger-scale simulant research project in 2002 that had been directed by a presidential order. The research group produced 1,000 liters of Tariq One—Nogoz as a nerve agent simulant, and Tariq Two—diethyl amine as a nitrogen mustard simulant. The compounds were colored with dye, and thickened with a polymer. He asserted that any symptoms from the formulated pesticides would pass within a half hour, according to ISG interviews with him.

## Annex E Al-Abud Network

### Summary

Triggered by a series of site exploitations and detentions in March 2004, Iraq Survey Group (ISG) began investigating a network of Iraqi insurgents—referred to as the al-Abud network—who in late 2003 and early 2004 actively sought chemical weapons for use against Coalition Forces. ISG created a team of experts—including operators, analysts, and technical ops officers—to systematically investigate and disrupt the al-Abud network and diffuse the immediate threat posed by the insurgents. The team also focused on identifying links between al-Abud players and former regime CBW experts to determine whether WMD intellectual capital was being tapped by insurgent elements throughout Iraq. By June 2004, ISG was able to identify and neutralize the chemical suppliers and chemists, including former regime members, who supported the al-Abud network. A series of raids, interrogations, and detentions disrupted key activities at al-Abud-related laboratories, safehouses, supply stores, and organizational nodes. However, the insurgent leaders and financiers within the network remain at large and alleged chemical munitions remain unaccounted.

### Organization and Preparation

Fallujah-based insurgents—belonging mostly to the Jaysh Muhammad organization—recruited in late 2003 an inexperienced Baghdad chemist to lead the development of chemical agents including tabun, mustard, and other nontraditional agents. The insurgents targeted the chemist because of his background in chemistry—albeit limited and with no ties to former regime CW program—and his access to chemicals in Baghdad’s chemical suk district. The insurgents appear to have recruited the chemist with financial incentives; however, debriefings of detained al-Abud network members suggest that the chemist was sympathetic to the insurgent’s anti-Coalition cause.

After identifying their chemist, the al-Abud network sought chemicals and equipment needed to conduct CW experiments. The al-Abud network had little difficulty in acquiring desired chemicals after OIF, including malathion pesticide and nitrogen mustard precursors. However, it remains unclear if their inability to acquire necessary precursor chemicals is attributed to a lack of supply or CW inexperience.

- The insurgents acquired most of the chemicals from farmers who looted state companies and from shops in Baghdad’s chemical suk.

The last component of the CW project involved dissemination of the agents. The al-Abud network relied on a political member of Jaysh Muhammad to provide the mortar rounds, which the insurgents would fill with agent for planned use against Coalition Forces. It remains unclear how the insurgents intended to utilize the rounds, either fired as mortars or detonated as improvised chemical devices.

### Initial CW Experiments

The al-Abud network first attempted to produce the nerve agent tabun in late December 2003, and the experiment was a self-admitted failure because the insurgents lacked the necessary chemicals. The product of the first CW experiment was a mixture of malathion and other chemicals, which by itself is a poisonous compound if disseminated properly.

- The al-Abud network used their malathion mixture to “weaponize” nine mortar rounds. The mortars likely are an ineffective means of dispersing the malathion because the detonation of the mortar will consume the poison.
- Malathion and tabun have similar chemical structures, however it is not possible to create tabun from malathion. The al-Abud chemist understood this limitation, but probably continued with the experiments to appease the insurgents.

The al-Abud chemist abandoned his tabun experiments after initial failures, but months later in March 2004 he considered trying to produce tabun from the

prescribed precursor chemicals, not malathion. Based on ISG investigations, the al-Abud network did not have the necessary chemicals. A lack of resources and insurgent backing probably forced the al-Abud chemist to cease his attempts to produce tabun.

### **Mustard Experiments and Weaponization**

After the initial attempt to produce tabun, the al-Abud network in late January and early February 2004 began acquiring materials for the production of nitrogen mustard. The al-Abud network had the necessary materials, but lacked the expertise, to produce nitrogen mustard.

- They failed to produce nitrogen mustard because the chemist used incorrect amounts of the precursors and inadequate processes.
- Following the mid-March failure to produce mustard, the al-Abud network sought the assistance of a young “chemist-for-hire”—who owned a small chemical lab in Baghdad—to refine their processes. The younger chemist also failed to produce nitrogen mustard.
- The al-Abud network approached the “chemist-for-hire” because of his reputation as a capable chemist in Baghdad. Although he did not have any prior CW experience or previous anti-Coalition tendencies, the young chemist willingly aided the al-Abud network as a profit-seeking mercenary.

With time and experience it is plausible that the al-Abud network could have mastered the processes necessary to produce nitrogen mustard. However, Coalition Forces disrupted the al-Abud network’s ability to produce nitrogen mustard when they detained the younger and more experienced al-Abud chemist and confiscated chemical precursors. Lacking the young chemists’ expertise, the network likely shifted its focus to the production of binary mustard.

In renewed efforts to produce mustard, the al-Abud network returned to the chemical suk in Baghdad to purchase necessary chemicals and began the weaponization of binary mustard rounds. Weaponization of binary mustard in mortar shells is relatively simple, however the insurgents poorly executed this procedure.

### **Ricin and Nontraditional Agent Production**

The younger al-Abud chemist—at the urging of the other al-Abud chemist and motivated by financial gain—successfully produced small quantities of ricin extract in March 2004 using widely distributed terrorist literature. ISG exploited the young chemist’s laboratory to reveal an operational lab setup designed for producing ricin cake—a substance that easily can be converted to poisonous toxin ricin. The production of ricin likely occurred without the direct knowledge of the al-Abud insurgents, but the chemists probably intended to sell the toxin for use against Coalition Forces.

- The lab setup contained the necessary raw materials and equipment to produce small quantities of ricin and was not capable of facilitating a mass-casualty ricin attack. However, the lab could have produced enough ricin to cause a few isolated casualties—if disseminated properly.

Within the same timeframe of the tabun and ricin experiments, the al-Abud chemists prepared two additional agents, napalm and sodium fluoride acetate, for the Jaysh Muhammad insurgents in the al-Abud network. ISG assesses their efforts to produce nontraditional compounds capable of causing mass casualties as highly unlikely.

### **Jaysh Muhammad**

Jaysh Muhammad (JM) is an anti-Coalition group with both politically motivated and religiously motivated elements that ISG began tracking after they produced chemical mortars. The politically motivated members are Ba’athist, pro-Saddam elements who tend to be of the Sufi religious soca. The Sufi enjoyed special status during the Regime and hold Izzat al-Duri, the ex-vice-president, in exceptionally high esteem. They were members of intelligence, security, and police forces from the previous regime.

According to detainee accounts, JM members, along with Fallujah based insurgents planned to use the CW rounds against Coalition Forces. Evidence suggests that JM acquired the rounds, although it remains unclear if they were used. Until we are able to capture the key figures of JM involved with al-Abud, it is unlikely we will determine what happened to the rounds.

### Ties to the Former Regime

ISG has found no evidence that the recent chemical weaponization attempts stem from the former regime's CW program or represent a prescribed plan by the former regime to fuel an insurgency. However, many of the known al-Abud personalities have ties to the former regime through either business relationships or political affiliations. Capitalizing on these connections, the al-Abud insurgents—including former Ba'athists—utilized a pre-OIF supply infrastructure to access chemicals and mortars.

- The primary chemical supplier in Baghdad—who had business ties to former regime companies as well as personal relationships with MIC and Iraqi Intelligence Service (IIS) officials—served as a facilitator for the al-Abud network, supplying chemicals and limited financial backing.
- The leadership of Jaysh Muhammad is comprised of mostly Ba'athists with ties to the former regime. Insurgent knowledge of pre-OIF infrastructure enabled the network to source and generate much of its chemical-biological warfare capability. Whether due to previous positions held or personal contacts within the former regime, much of the direct support derived from various former regime means.

### Ties to the Insurgency

ISG has found no evidence to confirm or deny that the al-Abud network is an integrated and coordinated piece of a larger insurgency campaign in Iraq. However, the al-Abud network's efforts are likely known to the insurgency because of the proximity in Fallujah of the al-Abud leadership and insurgent Zarqawi network. Additionally, the majority of figures in the al-Abud network are at least sympathetic to the insurgent cause.

### Implications

The most alarming aspect of the al-Abud network is how quickly and effectively the group was able to mobilize key resources and tap relevant expertise to develop a program for weaponizing CW agents. If the insurgents had been able to acquire the necessary materials, fine tune their agent production techniques, and better understand the principals behind effectively dispersing CW, then the consequences of the al-Abud network's project could have been devastating to Coalition Forces.

- Despite the fleeting nature of the insurgent's initial attempts, the al-Abud chemists progressively gained experience with CW, and continued different approaches with the same goal.

The al-Abud network is not the only group planning or attempting to produce or acquire CBW agents for use against Coalition Forces. ISG focused on the al-Abud network because of the maturity of the group's CW production, as well as, the severity of the threat posed by its weaponization efforts. Recent reporting from a variety of sources shows insurgent's attempts to acquire and produce CBW agent throughout theatre. The availability of chemicals and materials dispersed throughout the country, and intellectual capital from the former WMD programs increases the future threat to Coalition Forces by groups such as the al-Abud network.

*This page intentionally left blank.*

## Annex F Detailed Preliminary Assessment of Chemical Weapons Findings

### Chemical Munitions—Other Finds

#### Introduction

*Beginning in May 2004, ISG recovered a series of chemical weapons from Coalition military units and other sources.* A total of 53 munitions have been recovered, all of which appear to have been part of pre-1991 Gulf war stocks based on their physical condition and residual components.

*The most interesting discovery has been a 152mm binary Sarin artillery projectile containing a 40 percent concentration of Sarin which insurgents attempted to use as an Improvised Explosive Device (IED).* The existence of this binary weapon not only raises questions about the number of viable chemical weapons remaining in Iraq and raises the possibility that a larger number of binary, long-lasting chemical weapons still exist.

- ISG has no information to indicate that Iraq produced more binary Sarin rounds than it declared, however, former Iraqi scientists involved with the program admitted that the program was considered extremely successful and shelved for future use. According to the source, General Amer al-Saadi sought to downplay its findings to the UN to avoid heightened attention toward the program.

*Under UN Security Resolution 687, Iraq should have destroyed or rendered harmless all CW munitions, but we cannot determine without additional information whether the rounds we have recovered were declared or if their destruction was attempted.*

- An Iraqi source indicated that when weapons were forward-deployed in anticipation of a conflict, the CW weapons often became mixed in with the regular munitions, and were never accounted for again. Another source stated that several hundred munitions moved forward for the Gulf war, and never used, were never recovered by retreating Iraqi

troops. A thorough post-OIF search of forward depots turned up nothing—if the weapons were indeed left behind, they were looted over the 12 years between the wars.

- Iraq's unilateral destruction of weapons in 1991 was far from perfect—a February 2003 UNMOVIC inspection at the Al Azziziyah Firing Range to attempt to account for 157 R-400 bombs by inspecting the debris turned up 8 bombs that had survived the 1991 explosions. So it is possible that Iraqi—or even UN—explosion pits could have been looted of a few surviving munitions.
- Because of poor Iraqi inventory accounting, simple pilferage before or after the 1991 Gulf war could have resulted in some lost munitions.

#### May 04: 155mm Chemical Munitions Used as an Improvised Explosive Device

Military units recovered a 155mm artillery round near Baghdad International Airport. Analysis of the residue at the bottom of the round by ISG field labs returned positive indications for sulfur mustard CW agent. The lab results, type and condition of the round, and the lack of markings indicate it is an Iraqi CW-filled 155mm round left over from the pre-1991 Iraqi program. The lack of a driving band makes it difficult to determine whether the round was fired, where it was acquired, and suggests the band probably was looted (see Figure 1).

---

*Historical context: Iraq purchased thousands of empty 155mm artillery rounds designed to disseminate smoke chemicals. The original markings were generally painted over and the munitions filled with CW agent mustard. Over 10,000 of these rounds were destroyed under UN supervision, but they have not all been accounted for.*

*One of the key UN unresolved issues involves 550 mustard-filled rounds. An ISG investigation into this issue yielded inconsistent information about the final disposition of the 550 shells, with one official claiming they were retained for future use. The ISG has not been able to confirm these claims.*

---



Figure 1. 155mm sulfur mustard chemical round.

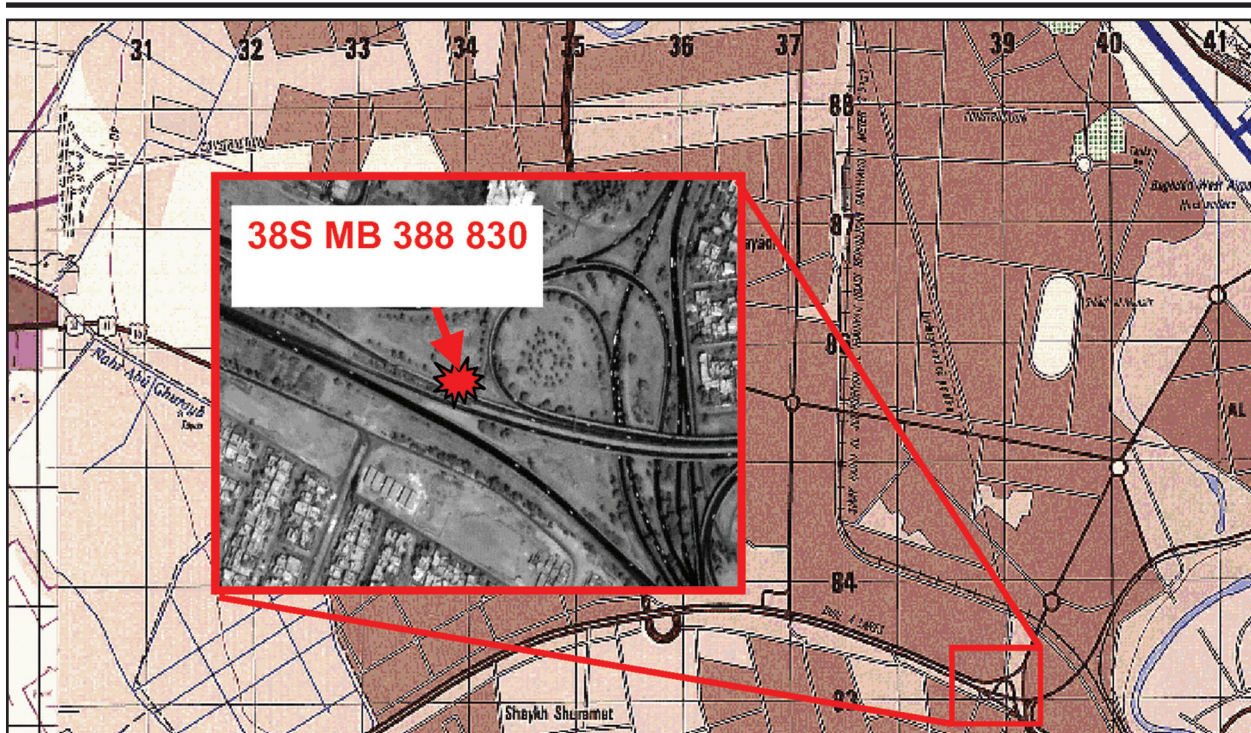


Figure 2. Location of binary Sarin round along airport and road.



### 16 May 2004: 152mm Binary Chemical Improvised Explosive Device

A military unit near Baghdad Airport reported a suspect IED along the main road between the airport and the Green Zone (see figure 2). The munitions were remotely detonated and the remaining liquid tested positive in ISG field labs for the nerve agent Sarin and a key Sarin degradation product.

The partially detonated IED was an old prototype binary nerve agent munitions of the type Iraq declared it had field tested in the late 1980s. The munitions bear no markings, much like the sulfur mustard round reported on 2 May (see Figure 3). Insurgents may have looted or purchased the rounds believing they were conventional high explosive 155mm rounds. The use of this type of round as an IED does not allow sufficient time for mixing of the binary compounds and release in an effective manner, thus limiting the dispersal area of the chemicals.

---

*Historical context: Iraq only declared its work on binary munitions after Husayn Kamil fled Iraq in 1995, and even then only claimed to have produced a limited number of binary rounds that it used in field trials in 1988. UN investigations revealed a number of uncertainties surrounding the nature and extent of Iraq's work with these systems and it remains unclear how many rounds it produced, tested, declared, or concealed from the UN.*

---

### 16 May 2004: 10 155mm Chemical Rounds

A military team interrupted a group of Iraqi individuals attempting to bury multiple projectiles at a location near Canal Road in Baghdad (see figure 4). The individuals fled the site when fired upon, and the military team captured multiple artillery rounds and other weapons at the site. ISG's field labs tested the recovered 155mm rounds and found some trace amounts of sulfur mustard and sulfur mustard degradation products in a few of the rounds. Technical experts found that each round contained a ruptured burster tube—inconsistent with UN destruction practices—suggesting that either Iraq unilaterally destroyed the rounds or looters attempted to drain residual agent from them (see figure 5).

---

*Historical context: Iraq declared in its 1996 Full, Final, and Complete Declaration (FFCD) that it produced 68,000 155mm sulfur mustard-filled rounds between 1981 and 1990. Of those produced, Iraq has not been able to account for the location or destruction of 550 155 mm shells. The bulk of 155mm destruction occurred between 1993 and 1994 and many of the log entries show that the mustard was partly polymerized, which is consistent with our findings in the recent sulfur mustard rounds.*

---

### 16 June 2004: Two 122mm SAKR-18 Artillery Rockets

An Iraqi source turned over to Polish Forces two 122mm rockets obtained at the Khamisiyah Depot—a former CW storage site declared by Iraq to have housed 122mm filled rockets (see Figure 6). Details about the provenance of these rounds remain unclear but the source Sarin/Cyclosarin believes the missiles were housed in a bunker struck during the Gulf war and subsequently hidden in canals and lakes in the area. Analysis of the liquid residue revealed the nerve agents Sarin (GB) and Cyclosarin (GF) as well as a number of impurities and known degradation products of GB and GF. Given the age, leakage, decomposition of nerve agent, and small quantity of remaining liquid, these rounds would have limited, if any, impact if used by insurgents against Coalition Forces (see Figure 7).

---

*Historical context: Iraq declared having produced the following numbers of 122mm nerve agent rockets, but made no distinction in its declaration about the type of sarin fill: GB, GF, or GB/GF mix. We suspect, based on data from the declaration and the UNSCOM 239 Report that GB/GF-filled rockets were included in the 1988 and 1990 declaration figures. Although the origin of these rockets has not been clearly stated, the Khamisiyah Ammunition Storage Depot where the rockets were found has a long history of CW storage, Coalition bombing, and UN investigation.*

---

---

### ***Origin of the Binary Sarin Round Used on BIAP***

*The binary chemical round detonated near the Baghdad International Airport (BIAP) probably originated with a batch that was stored in a Al Muthanna CW complex basement during the late 1980s for the purpose of leakage testing. Iraq placed at least 12 filled binary Sarin munitions, either 152 or 155mm projectiles, in the basement of the Salah al-Din laboratory at the Al Muthanna CW complex, according to a report.*

- *The same report claims that only 20-30 binary 152mm rounds were produced, and the program switched to 155mm rounds after the 152mm rounds were expended in testing. The report stated that all of the binary munitions with aluminum canister inserts (such as the one used on BIAP) should have been used in field testing, but some may have been set aside for leak testing at Al Muthanna.*
- *A different report stated that as of 1988 no binary chemical rounds were stored at any other location besides the Salah al-Din laboratory, and that the rounds were kept in the basement to test for leakage and chemical degradation.*
- *A third report speculated that binary rounds may either have been buried or moved to one of two bunkers in the mid-1990s when the UN ordered the Al Muthanna complex to relocate a large number of chemicals and munitions. The same report said that Salah al-Din al-Nu'aymi, the manager of the binary Sarin munitions project, frequently stored munitions he was working on but had not tested in the basement of his laboratory at Al Muthanna.*
- *A fourth report said that 20-40 binary shells were kept in the "special stores" at Al Muthanna as of the late 80s, but the source believed that these had been destroyed by UNSCOM. ISG has been unable to verify from UNSCOM reports that any binary shells were destroyed at Al Muthanna.*

***The Technical Research Center (TRC) also worked on producing 152mm binary Sarin artillery shells, but we have no reason to believe that they possessed functional chemical munitions.***

- *According to the Iraqi FFCD, the TRC conducted lab experiments with 152mm binary munitions using a simulant to test the mixing of the binary components. No binary tests using chemical agent at the TRC were declared.*
- *According to one report, the Iraqi Intelligence service officer Ali Muklif ran the binary program, and the deputy director of the Military Industrialization Commission, Amir al-Sa'adi, ordered the work. The report claimed that al-Sa'adi provided the TRC with chemicals and possibly 152mm rounds, but the report did not elaborate on the work performed by the TRC.*

***The disposition of the 152mm and/or the 155mm artillery projectiles after the Gulf war is unknown, although it is possible that the rounds remained at the Al Muthanna complex and were looted after OIF.***

- *Even though Al Muthanna has been extensively investigated by UN and ISG teams, the complex covers 10 square miles, which makes it difficult to fully exploit. An ISG team that went to the site in January said that looters appeared to have been at several parts of the Al Muthanna complex.*
- *Several parts of the Al Muthanna complex were bombed or in poor condition throughout the 1990s. These areas pose a health risk to exploitation teams, but looters have shown themselves to be less risk-averse than ISG personnel. It is possible that the round was removed from an area in Al Muthanna that was deemed unsafe to exploit.*
- *An alternate explanation is that rounds were moved out of Al Muthanna and stored at a different location in the early 1990s, where it was later looted after OIF, although we have no reporting to substantiate this possibility.*

*The actual number of filled binary artillery shells produced by the Iraqi CW program during the 1980s is unknown, but we assess that only a handful of filled binary rounds would have existed after the Gulf war.*

---

---

**Origin of the Binary Sarin Round Used on BIAP (continued)**

- According to a report, the National Monitoring Directorate only asked for the number of binary CW rounds Al Muthanna tested, not the number it actually produced. The Iraqi FFCD from June 1996 states that 10-12 152mm and 160 155mm binary Sarin artillery shells were field-tested.
- If the number of 152mm artillery shells produced by Al Muthanna was a few dozen, as was stated in the aforementioned sensitive report, then the shells which remained in the basement of the Salah al-Din

Laboratory in the late 1980s may have been the only filled binary sarin rounds which existed at the time of the Gulf war.

- Reporting states that the only 152mm binary Sarin rounds produced by Al Muthanna that were not destroyed in field tests were in the basement of the Salah al-Din laboratory. The report stated that at least 12 binary munitions were placed there, although they may have been 152mm, 155mm, or a mixture of both.

---

**Historical context:** Prior to the Gulf war, the Iraqis had stored SAKR munitions in bunkers at the Khamisiyah Depot and moved some of them to a nearby depression near a canal prior to the conflict to avoid combing. During the Gulf Conflict US ground forces captured the Khamisiyah Depot and blew some of the storage bunkers without knowledge of CW munitions there.

UN inspectors have since visited the site and UNSCOM's figures for these 122mm munitions indicate that between 350 and 400 are not accounted for—almost certainly the rounds that remained in Building 71 after its demolition. Between 1991-1998 Iraqi's looted the structure, and in doing so disposed of the contents, including weapons. The likelihood is that the rounds were chucked into nearby piles of earth, which were in turn covered by more debris.

---

**25 June 2004: 17 Additional 122mm SAKR-18 Artillery Rockets. July 2004: 22 Additional 122mm SAKR-18 Artillery Rockets**

An additional 17 rockets from the same cache described above (d) were identified at the Khamisiyah Depot by the same source. (See figure 8). Sixteen were returned to ISG for analysis and one was exploded onsite because it retained an intact rocket motor that posed safety concerns. Most of the rounds had been severed, exposed to heat, or were partially destroyed. Four intact rounds were separated for testing and returned a preliminary positive result for G-series nerve agent. None of these rounds retained a liquid fill line, suggesting the agent had degraded over time. 22 more rockets were discovered at Khamisiyah. 21 were in deteriorated condition with only one intact rocket with residual riot control agent present. (See figure 9).

---

**Historical context:** These 122mm SAKR-18 rockets were discovered at the Khamisiyah Depot. Please refer to the box above for relevant historical context.

---



Figure 3. 152mm binary Sarin round used as IED.

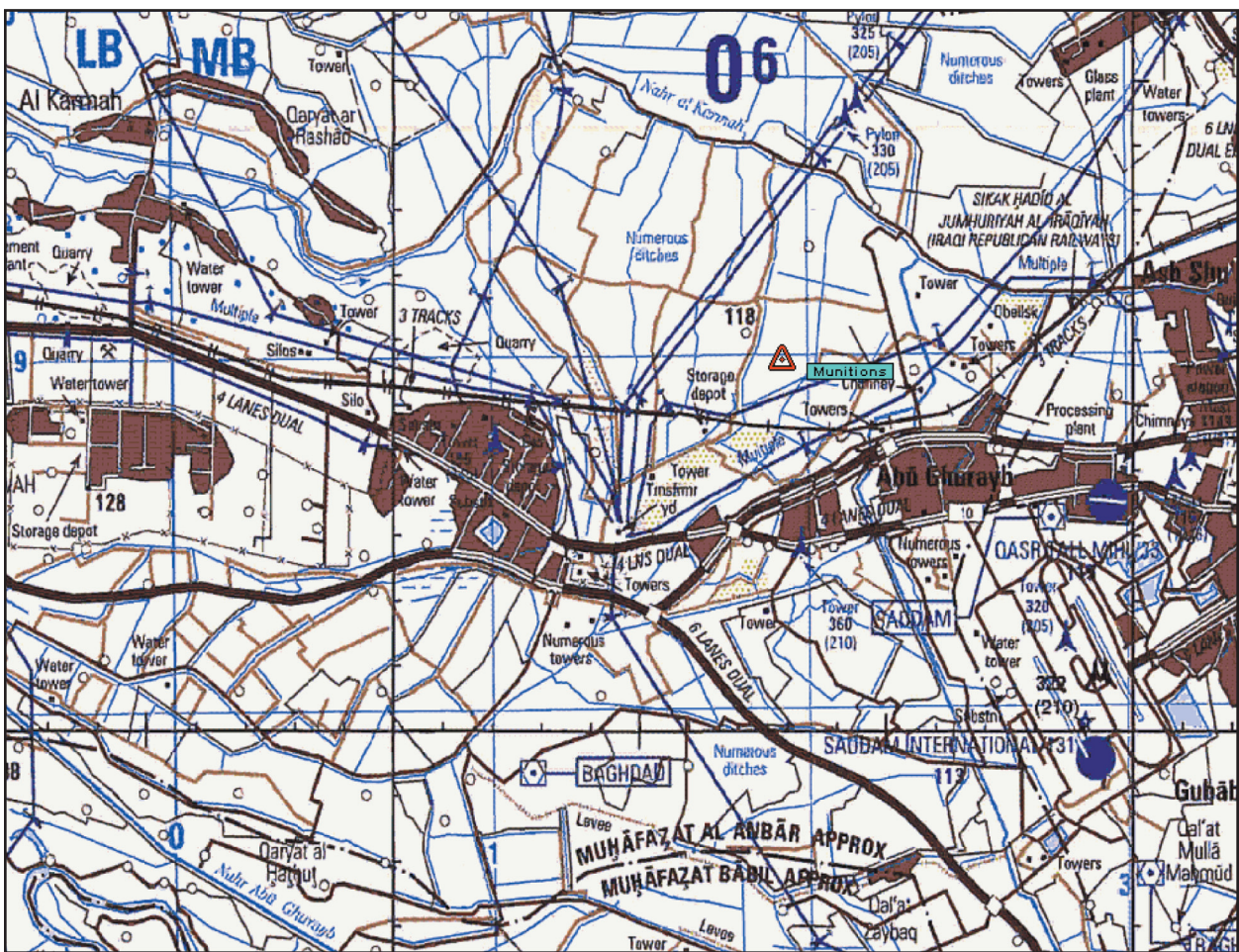


Figure 4. Location of chemical rounds along canal road.



Figure 5. Examples of the 10 155mm chemical rounds and x-rays of ruptured burster tubes.

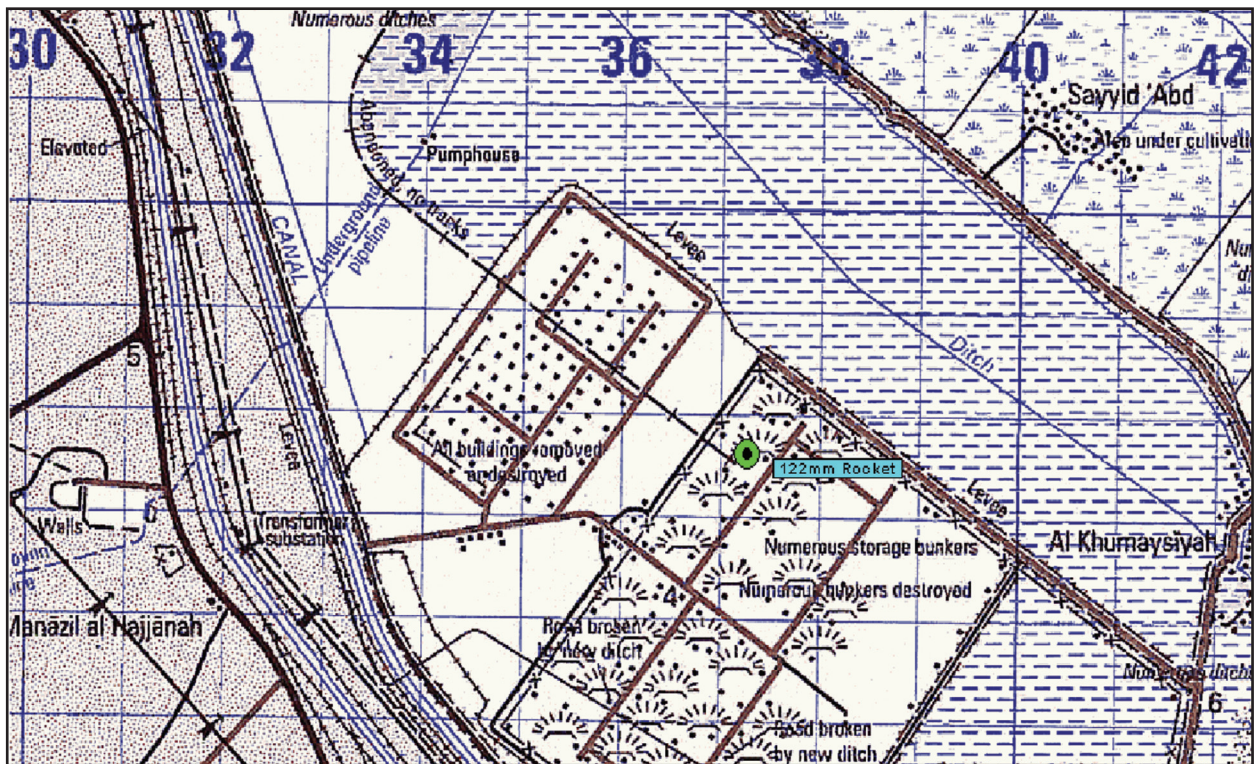


Figure 6. Location of SAKR-18 rockets at Khamisiyah depot.

Chemical



*Figure 7. Photos and x-ray of SAKR-18 rockets.*



*Figure 8. Additional SAKR-18 rockets turned in from Khamisiyah depot.*



**Figure 9.** Additional SAKR-18 rockets turned in from Khamisiyah depot.

*This page intentionally left blank.*



## Annex G Chemical Warfare and the Defense of Baghdad

*ISG investigated reporting that Iraq used a defensive doctrine during OIF that included the employment of a “red line,” beyond which the Iraqis would have used available WMD against Coalition forces. Since OIF, we have conducted numerous interviews of senior regime officials and military officers in an effort to confirm whether Iraq had weaponized CW ready to use or whether there was a “red line” concept that would have triggered a CW attack.*

*We believe that there was indeed a “red line” defense for Baghdad, but it was a simple multi-ring conventional defense that quickly broke down under Coalition assault, and not the coordinated, prepared plan depicted in prewar intelligence reporting.*

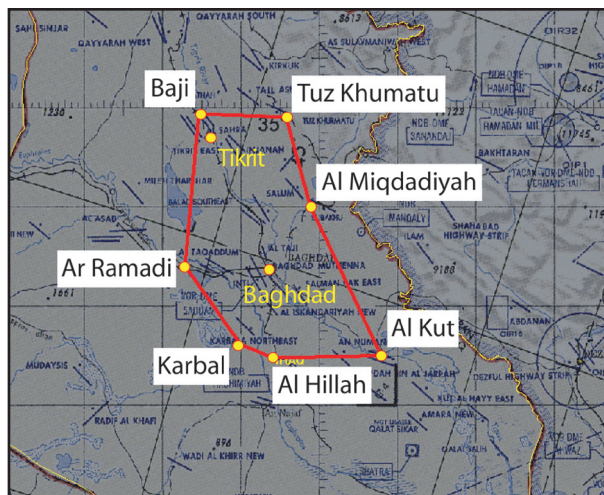
- Evidence of strategic planning at the Diwan and flag-officer levels is lacking in any mention of CW.
- Many Iraqi Generals believed there was a secret plan to use CW, but we have found no evidence that the SSO—which was involved in past CW uses—was part of any planning for CW use.

Prior to OIF, historical reports describe Iraqi plans for defensive use of CW to disrupt or halt the advance of enemy troops and to disrupt enemy staging areas before their attack.

- As early as 1991, prior to Desert Storm, Saddam decided to use CW if Coalition forces crossed a parallel extending west from Al Amarah or if Iranian troops crossed the border into Iraq, according to reporting.

*During the run-up to OIF, the Intelligence Community received additional information pointing to a “red line” around Baghdad that, if crossed by Coalition forces, would trigger an Iraqi CW attack.*

- According to a Kurdistan Democratic Party (KDP) member, Saddam in October 2002 authorized the use of prohibited weapons at the discretion of four field commanders if US forces closed on Baghdad. One of the four field commanders was Kamal



**Figure 1.** Red line for triggering CW use, October 2002.

- Mustafa, the Republican Guard Secretary. The “red line” was described as a box around Baghdad encompassing the cities of Tuz Khurmatu, Bayji, Ar-Ramadi, Karbala, Al-Hillah, Al-Hillah, Al-Kut, and Al-Miqdadiyah (see Figure 1).
- According to a senior Iraqi Ministry of Foreign Affairs official, in early February 2003, Saddam had decided to use CW against US troops in the event of war.
- Reportedly in a mid-February 2003 meeting, senior members of the Iraqi armed forces and Ba’ath party members discussed plans to release unknown chemical agents by remote detonation in six populated areas near the Saudi-Jordanian frontier and in western Iraq.
- According to a foreign government service, as of 16 March 2003, the 108<sup>th</sup> artillery battalion of the Baghdad Republican Guard Division in Al-Kut was under orders to use CW on Coalition forces if they approached Al-Kut. The battalion was reportedly equipped with CW shells, including mustard and unidentified binary agents, and was commanded by Col. Muhammad Ibrahim Sulayman.

---

### ***Origin of the Red Line—The Sandhurst Approach***

***Information acquired from various military sources and documents indicates that Iraq developed a defense doctrine that included a directive to defend to the last by all means necessary once Coalition forces approached a red line.*** Sources report that Saddam's Leadership Defense Plan was based upon a tactical doctrine taught to all Iraqi Officers, but we have not found evidence that the plan explicitly included a trigger for CW use.

- The defensive tactical doctrine was originally taught to Iraqi Officers at the Royal Military Academy, Sandhurst, United Kingdom, in the 1950s, and later similar doctrines were taught to Iraqi officers at British-style training courses in Pakistan. The fundamental principles are based upon concentric defensive perimeters or layered defensive lines.
- The defenses usually consisted of four lines:

—4<sup>th</sup> line (yellow)—line along which reconnaissance units usually deploy;

—3<sup>rd</sup> line (green)—first line of defense against advancing units;

—2<sup>nd</sup> line (blue)—first major fallback positions for the units stationed at the blue line—additional troops, supplies, and ammo stationed here;

—1<sup>st</sup> line (red)—innermost defense line or last line of defense and final fallback position for troops. Advancing forces would meet the heaviest resistance here, and it was the final staging area.

Reporting indicates that the multiline defense was attempted by some Iraqi forces defending against Coalition advances during OIF, with poor results:

- The 34<sup>th</sup> Infantry Division used the method in defending the Khanaqin Border Crossing—however, Coalition forces moved so rapidly and so many Iraqi soldiers deserted that the situation quickly became chaotic, and the notion of falling back to a stabilized line or lines was impossible.
- In addition, the 5<sup>th</sup> Mechanized Division used this doctrine in its defense of Kirkuk, but its lines successively collapsed under Coalition air assault.

---

### **Late 2002–Early 2003: Struggling To Generate a High-Level Defense Strategy**

***Available evidence indicates that the Iraqi Pre-OIF defense strategy evolved over a rather short time, from mid-2002 through the end of that year, and transitioned to the level of detailed tactical planning only shortly before OIF*** (see Chapter 1, Regime Strategic Intent).

- Even as Coalition forces built up around Iraq, Saddam continued to believe that they would not invade or attack Iraq; this belief was dispelled only by the beginning of OIF itself;
- Saddam perceived his armed forces to be stronger than they were and thought a Coalition invasion, if it did occur, would never penetrate as far as Baghdad;

- In fact, Saddam believed that a popular uprising would occur as the Coalition invasion progressed;
- Saddam's inner circle reinforced his faulty perceptions out of fear of Saddam's reaction.

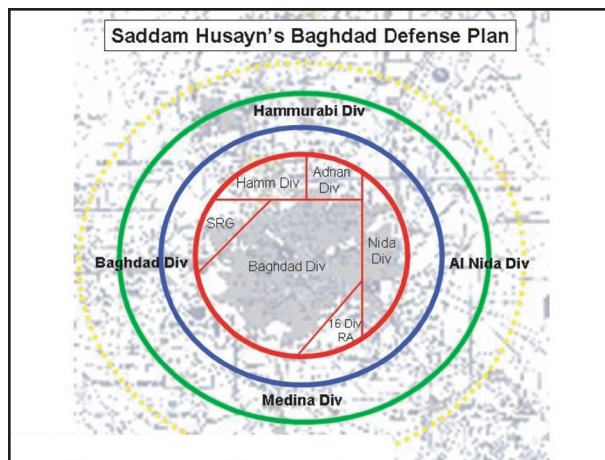
***High-Level Discussions Began in Earnest Only in Mid-2002 on a Regime Defense Plan.*** Starting in mid-2002 through OIF, the Intelligence Community received reporting that the Iraqi regime intended to use CW if Coalition forces invaded Iraq or threatened Baghdad. Iraq's layered defense plan reportedly included the use of chemical weapons once Coalition forces crossed the defensive "red line." Discussions about the deployment of WMD reportedly took place at various military levels, according to multiple reports.

- In August 2002, reporting indicated Saddam Husayn had selected a pool of approximately 100 experts and scientists to “solve Iraq’s problems” pertaining to the advancement, protection, and concealment of WMD programs. Rewards were reportedly provided to those scientists who came up with ideas for using WMD to thwart any potential US attack on Iraq.
- Reporting at various levels indicates WMD use was discussed; however, no source has been able to provide detailed plans how Iraq was going to use WMD against a Coalition invasion.

*Reportedly both before and after OIF, planning an Iraqi defense strategy against Coalition forces underwent several stages. An initial plan appears to have been delivered by December 2002 and most likely underwent revisions until OIF.*

- A senior Iraqi officer with direct knowledge of Iraqi war planning stated during OIF that at a meeting in December 2002, high-level Republican Guard Commanders and staff officers received the final orders on how Baghdad was to be defended from LTG Al-Rawi.
- Reporting prior to OIF from a senior active-duty Iraqi military officer indicated in early February 2003 the RG leadership was preoccupied with tactical defense planning against a possible Coalition attack. Defense plans were posited on three defensive lines, with the third and final line including Baghdad and its suburbs. Conventional training had been intensified by senior command, but there had been no increase in CBW training programs. Typical defensive chemical protection clothing and related materiel were provided, as were defensive chemical-warfare-related procedures.

*Interrogations with several Iraqi division-level officers after OIF confirm that Saddam’s Defense Plan was based upon a layered defense doctrine. The innermost circle of defense was referred to as the “red line.” Once Iraqi troops retreated to the red line position, they were to “hold to the last” without further retreat, presumably ready to employ all available weaponry (see Figure 2).*



**Figure 2.** Schematic representation of “red line” and defense posture based on a senior Iraqi officer involved in pre-OIF war planning.

- Interrogation of a senior Iraqi officer with direct knowledge of Iraqi war planning during OIF revealed that on 18 December 2002 the former RG High Level Commanders and Staff Officers met with former RG Chief of Staff LTG Sayf Al-Din Al-Rawi, Qusay Husayn, Former RG Commander, and Saddam Husayn to receive orders for the final Defense of Baghdad.
- According to the same source, Baghdad’s defenses would be based upon three defensive lines—units would fall back from one line to the next on orders from Saddam Husayn. The last line of this defensive plan was considered the red line, but, according to the officer, *CW was not part of the defensive strategy because Saddam had indicated in a meeting that he had none.* LTG Al-Rawi has eluded capture, and we have not been able to corroborate this information or confirm this meeting.
- Interrogations with Former Staff Maj. Gen. Salih Ibrahim Hammadi Al-Salmani—head of the Baghdad division of the Republican Guard during OIF—indicated that all Iraqi forces were given a preestablished red line to defend. Consistent with Sandhurst teachings, the red lines were established by HQ and were the final defensive fallback position where troops were to fight with the strongest resistance.

Chemical

By April, the regime was nearing its end, and the discussions it had were no longer useful:

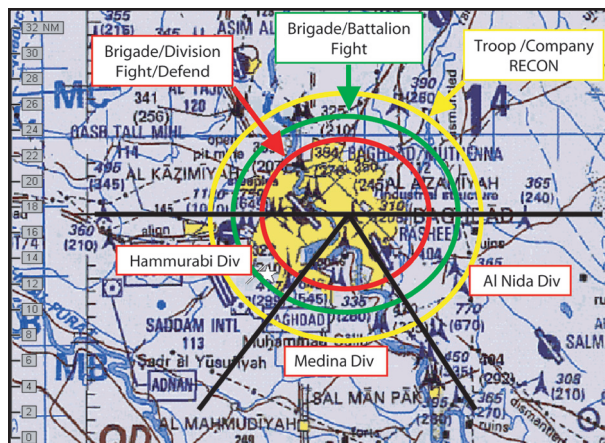
- Latif Nusayyif Al-Jasim Al-Duri—former member of the RCC and Deputy Secretary of the Ba’ath Military Bureau—indicated that at the last meeting he attended with Saddam and leading military and political figures in April 2003, Saddam was still asking “what kind of weapons preparations were accomplished and if any more were needed.”
- Al-Duri claimed that preparations for missiles and CW were not discussed but noted that the meetings were brief, which was unusual for revision and fine-tuning of a last-ditch defense plan. Other attendees regarded this as the farewell meetings rather than a planning meeting. Tariq Aziz also substantiated the fact that the last meeting with Saddam still did not include in-depth tactical discussion or presentation. This lends credence to the fact that the defense plan never came together at the tactical level (see Figure 3).

Figure 3 denotes Former Staff General Salih al-Salmani’s impression of the red-line doctrine for the defense of Baghdad (the graphic provides an approximation of the layered defense structure). This graphic is a similar to Figure 2 on the previous page in denoting the layered defense and red line.

### Flag-Level Opinion—No Knowledge of CW Plans, but Conventional Wisdom Expects It

*At the same time as policymakers at the Presidential level were trying to generate a plan for defense against the Coalition, generals and high-level defense officials believed that a plan for CW use existed, even though they themselves knew nothing about the details.*

Several high-ranking Iraqi military officials claimed CW was not part of an organized Iraqi Defense Plan but kept open the possibility that discussions took place in closed venues at higher levels. This suggests that Iraqi conventional wisdom agreed that CW was part of a secret plan, even in the absence of direct evidence:



**Figure 3.** Former Staff General Salih al-Salmani’s impression of the red-line doctrine.

- A major contributor to the Iraqi Defense Plan, former Defense Minister Sultan Hashem Ahmad Al-Tai, was captured by Coalition forces in September 2003. The Minister asserts that at no time was WMD discussed in strategy meetings to lay out an Iraq Defense Plan but does not rule out the possibility that discussions ensued at higher levels.
- Sultan Hashem was never directly asked if the red-line doctrine included the use of CW; however he firmly asserts that WMD use was not a topic of the defense plan and would have been a topic for a different, compartmentalized forum. Hashem also noted the large number of people who were shocked when Saddam announced in December 2002 in an open forum that Iraq did not possess WMD.
- After OIF, the commander of the Iraqi military’s chemical corps, Gen. Amar Husayn al-Samarrai informed the US that Iraqi leaders had intended to concentrate their forces around the critical cities of Baghdad, Basrah, Mosul and Tikrit, with each city surrounded by several defensive layers. Samarrai was not aware of any offensive strategy to use CW against Coalition forces but indicated his job was to make sure the Iraqi military was fully equipped to handle a coalition chemical attack.

---

### ***Investigation Into Nontraditional CW Use—The Fedayeen Saddam***

*Traditional tactics in the deployment of CW would have been under the control of Saddam and Qusay Husayn with the SSO and RG delivering and deploying the munitions either by missile (with heavy MIC assistance), mortar, or artillery. However, ISG also investigated whether there was any evidence of CW use planned by the two most skilled groups in unconventional/nontraditional tactics and methods, the Saddam Fedayeen and the IIS, specifically the special operations elements of M14 cooperating with M16 technical experts.*

*There are no indications from the limited intelligence available that Fedayeen doctrine included the use of CW if a red line was breached. There is some evidence to indicate that ‘Uday wanted to deploy CW, but was unable to obtain them.*

- *According to reporting prior to OIF, in mid-March 2003, ‘Uday Saddam Husayn sought CW agents from OMI and tasked Muhammad Khudayr Al-Halbusi Al-Dulaymi—then director of IIS M-14—who asked Imad Hussayn ‘Abdallah ‘Al-‘Ani (the father of Iraq’s VX program), to provide an unspecified CW agent. Dulaymi dispatched a courier who communicated the message to Al-Ani. Al-Ani asked for two weeks to study feasibility as a delaying tactic and replied after two weeks that OMI facilities were not capable of producing CW agents and the required chemical precursors were not available in Iraq. However, after OIF Muhammad Al-Dulaymi was interrogated on 17 July 2004, he asserted that ‘Uday Husayn never contacted him requesting chemical weapons.*

- At the onset of OIF (late March), according to a foreign government service, an Iraqi security official indicated that Iraq’s chemical weapons munitions had been removed from Baghdad as a result of the coalition air attack. He contends the bombing in late March 2003 resulted in the inability to prepare chemical weapons immediately against Coalition forces.
- Preliminary searches of the recovered documentation do not reveal written or recorded official documents regarding an Iraqi defense doctrine and execution orders for CW.

### **Post-OIF Reporting on Red Line**

***Interrogations, interviews, and documents obtained after OIF have confirmed that the “red line” was indeed part of regime planning, but they have not revealed a plan by Iraq to use CW at a pre-positioned red line.*** Information from numerous military officials indicates that Iraq was not able to use chemical weapons at the time of OIF, although ISG has not been able to locate and debrief some of the key Iraqi military commanders. Exploitation of military sites within the identified “red line” revealed no large cache of chemical weapons or indications that large amounts of chemical weapons were present (for further information, see Annex C).

- Reporting prior to OIF that Saddam in early October 2002 authorized the use of prohibited weapons at the discretion of four field commanders was contradicted by one of the field commanders who surrendered to Coalition Forces in May 2003. Former Staff Gen. Kamal Mustafa claims he did not have WMD at the time of war and indicates that the ‘red line’ plan did, in fact, exist but was simplistic in nature.
- According to the reporting, “special weapons” could have been employed dependent on certain conditions, such as climate and troop disposition, once Coalition forces breached this red-line perimeter. There were no indications of chemical weapon use when Coalition forces breached this zone, although sand storms and high winds, or dispersed troop formations, might have prevented the use of CW.
- During OIF, reporting from a former senior Iraqi Special Security Organization Officer with direct access indicated in early March 2003 the Iraqi Regime planned to defend Baghdad by establishing seven rings of defense. The source believed that “extreme defense measures” would be employed, and these measures would include WMD under the control of Qusay Husayn. The former officer also believed the defense plan was impenetrable and never executed because of a breakdown of the Iraqi military.

Chemical

### **No Evidence of Red Line Defense Plan With CW Use at the Unit or SSO Level**

*Traditionally, the RG Deployed Chemical Weapons Under Ad Hoc Control of the SSO.* Past doctrine would have the SSO deliver unmarked chemical weapons to the RG, who would fire the weapon at a location dictated by an SSO officer. We assess RG Commanders were not aware of SSO intentions prior to the chemical weapons use. This notion supports a CW use concept that would have been compartmentalized and therefore not discussed at most defense planning meetings.

*Available evidence is not consistent, however, with a compartmented CW use program involving SSO assets:*

- Pre-OIF reporting from the Kuwait government service from a source with good access indicates that, as of 16 March 2003, the 108th artillery battalion of the Baghdad Republican Guard (RG) division in Al-Kut was under orders to use CW on coalition forces if they approached Al-Kut. The battalion, commanded by Col. Muhammad Ibrahim Sulayman, was reportedly equipped with CW shells, including mustard and unidentified binary agents. However, this source was contradicted during OIF by a senior RG artillery officer with direct and indirect knowledge of information on the use of chemical weapons use for the 108th artillery battalion, who asserted that the 108th did not receive any chemical weapons.
- Another source claimed that, unlike the Iran-Iraq war, SSO personnel did not deliver ammunition during OIF, and the SSO officer attached to the 108th, CPT Jamal Al-Tikriti, did not bring chemical weapons with him.

*Post-1991 to OIF, a senior scientific advisor to Saddam through interviews conducted after OIF shed light on the launch procedures for modern Iraqi missiles. He asserted that, because of the complexity and prototype nature of the new systems, technicians from the Military Industrial Commission (MIC) would be heavily involved in missile preparations, aiming, and launching. RG and SSO involvement would be unlike pre-1991 doctrine.* The military would only provide the target by direction from “a single location.”

- A senior scientific advisor to Saddam through interviews conducted after OIF provided insight into the missile launching procedures. MIC technicians reportedly launched all available Al Samoud and Al Fat’h missiles. However, missiles experienced enough faults, due to their prototype status, that they required technicians to be on hand continuously to fix problems as they were detected. The MIC technicians then aligned-aimed the missiles and conducted the launch operations. The Iraqi military was responsible only for relaying the targets to the MIC-OMI technicians.
- All targeting information came from on location and field commanders had no say in the matter. Regarding WMD warheads and who would have control of the warheads (MIC, SSO or RG) the source states there were no WMD warheads.

## Annex H Summary of Key Findings at Captured Enemy Ammunition Consolidation Points

### Exploitation of Captured Enemy Ammunition Supply Points

As of 27 July 2004, 9,758 Iraqi munitions caches had been found and scheduled for destruction. Coalition forces are almost finished with the process of consolidating the known caches into one of seven Captured Enemy Ammunition (CEA) Depots. In order to examine the maximum amount of munitions possible, ISG teams visited these CEA depots to exploit a broad spectrum of Iraqi munitions, possibly including WMD-capable projectiles, rocket, missiles, or bombs. In addition to the assessment and exploitation of munitions, the teams also provided the on site contractors with handouts explaining which munitions are of interest to ISG and how to contact ISG should any suspected munitions be found. The seven CEA depots are listed in Table 1.

**A variety of munitions were exploited by ISG teams. Highlights include the Al Fat'h missile and the 81mm aluminum rockets, which figured prominently in the "aluminum tubes issue," as well as many other types of munitions including cluster bombs, rockets, and artillery projectiles (see Figures 1 and 2).**

#### An Najaf CEA Depot

An Najaf is located in central Iraq (approximately 120 km south of Baghdad). The An Najaf Depot contains 87 intact earth-covered bunkers; 42 destroyed warehouses, and approximately 99 revetments. An Najaf Depot covers an area of 5 km by 6 km and is secured by a 7ft barbed wire fence. The bunkers, located at the northern end of the depot, are in four major groups, each group consisting of five pentagon shaped sub-groups containing five bunkers each. The warehouses are located to the south in rows of seven warehouses by six rows for a total of 42 warehouses. All of the warehouses were destroyed by unknown explosions.



Figure 1. Al Fat'h missile.



Figure 2. 81mm rockets.

An Najaf ACP is currently under the operational control of Foster Wheeler Tetra Tech.

- An item of interest found at this site was determined to be an Iraqi copy of the Spanish Fuel Air Bomb, and Surface-to-Air missiles. Bunkers, destroyed warehouses, and the revetments were exploited with no WMD weapons found (see Figures 3, 4, 5, and 6).

**Table 1**  
**Captured Enemy Munitions (CEA)**

CEA Depot	Contractor in Charge of Site	Location MGRS	Location GEO
An Najaf	Foster Wheeler Tetra Tech	38S MA 14975 58003	N32.09.190 E044.05.540
Arlington	US Environmental	38S LD 53499 73957	N 34.59.858 E043.23.679
Az Zubayr	Foster Wheeler Tetra Tech	38R QU 58237 50953	N30.15.530 E047.40.210
Buckmaster	EODT	38S LD 63444 10878	N34.25.490 E043.30.490
Jaguar	US Environmental	38S LE 03320 51830	N35.41.447 E042.49.583
Paladin	EODT	38S LB 77958 77610	N33.13.829 E043.41.401
Taji	EODT	38S MC 31780 13636	N33.33.360 E044.15.540



*Figure 3. Destroyed warehouses.*



*Figure 4. Al Fat'h missile in shipping container.*



*Figure 5. Iraqi fuel air bomb.*





**Figure 6.** Bunker with 152mm artillery projectiles.

#### **Arlington CEA Depot**

Arlington CEA Depot is located north of Tikrit and about 200 km north of Baghdad and receives ammunition from the northern sector of Iraq. The Arlington Depot contains 100 intact earth covered bunkers, 79 intact and two destroyed warehouses, roughly 1,000 revetments, approximately 100 mud huts, and open storage. Arlington comprises an area roughly 2 km by 8 km surrounded by a 6-foot fence and guard towers. Arlington CEA Depot is currently under the operational control of US Environmental, Inc.

- The bunkers are located at the north end of the depot, the warehouses are to the south. Revetments are scattered though out the depot. Two of the warehouses were destroyed by unknown explosions presumably prior to OIF.
- All bunkers and revetments were neat, orderly, and easily exploited. Multiple types of munitions were found including airdrop bombs, cluster bombs, rockets, surface-to-surface missiles, and air-to-air missiles. Large quantities of ammunition were found including many types of rockets, RPGs, artillery projectiles of various caliber, and small arms. The majority of the munitions in the bunkers are stored in their original shipping containers. The warehouses contained large quantities of artillery projectiles, tank munitions, and limited quantities of antitank and antipersonnel mines. The revetments housed primarily 57mm munitions. All of the bunkers and warehouses were exploited.



**Figure 7.** Piles of 122-mm HE rockets.

- The 142-inch long, 122mm crates are indicative of the Sakr-18 rocket. The team counted 120 long crates and inspected 29 of them. The other 92 crates were not checked due to safety concerns. That is, the 142-inch long crates were at the rear of a full bunker, with a 1-foot wide center walk space between munitions stacked 6 to 7 foot high. A random sample of the long crates was conducted by going four crates deep near the center of the 120 crates, stacked 9 crates high. After sampling the crates, the pile started to shift. With no room to escape if the crate piles collapsed, the team broke off the exploitation.
- No WMD Munitions were found, (see Figures 7, 8, 9, 10, 11, and 12).

#### **Az Zubayr CEA Depot**

The Az Zubayr CEA Depot (alternate spelling Ash Shuaybah) vicinity south of Basra. Az Zubayr contains 31 intact and 17 destroyed earth-covered bunkers, 29 open storage pads, and an open receiving area for captured enemy ammunition being received at this location. Ammunition is shipped from southern Iraqi cache sites. Az Zubayr encompasses an area roughly 2 km by 3 1/4 km surrounded by a 6ft fence and guard towers. Az Zubayr Depot is currently under the operational control of Foster Wheeler Tetra Tech.



**Figure 8.** Ammunition crates in bunker.



**Figure 11.** Example of a full bunker.



**Figure 9.** 155-mm smoke projectile.



**Figure 12.** Cluster bombs.



**Figure 10.** 3,450 155mm HE artillery projectiles.

- The 17 destroyed bunkers were completely leveled, with little of the foundations remaining. The west building is called the missile building and is largely intact, with unexploded ordnance buried under the floor. Large multi-roomed buildings were located near the bunkers to the east. Onsite contractors stated this area was originally the Naval Munitions School for the Iraqi navy. The longest bunker is 330 ft long, with both the entrance and the road network constructed below grade.
- Multiple types of munitions were found, including airdrop bombs, naval mines, torpedoes, and missiles. The destroyed bunkers were exploited, yielding evidence of two Silkworm missiles (both were tagged by a UN inspection team, however the label

number was unreadable. One of the open revetments contained over a 100 special 81mm green aluminum rockets. Presumably, these are missiles associated with so-called “aluminum tubes issue” (see the Nuclear Section of this report for more information).

- No WMD munitions were found (see Figures 13, 14, 15, and 16).

### **Buckmaster CEA Depot**

Buckmaster CEA Depot is located in central Iraq 149 Km north of Baghdad. This depot is an extension of the Taji Depot and ammunition is shipped here from caches in central Iraq. Buckmaster comprises an area of nearly 5.5 km by 3 km surrounded by a 6-foot fence and guard towers. The bunkers are primarily located on the east side of the depot. Revetments and open storage are scattered throughout the depot, primarily from the center to the east edge boundary fence.

- Buckmaster Depot contains 100 earth-covered bunkers, 96 of which are intact. Four bunkers were destroyed by US ground forces during OIF. Hundreds of revetments, in addition to mud huts and open storage areas, are scattered randomly throughout the depot. Larger missiles, including 32 FROGs, are stored in the open, along with French Exocets and surface-to-air missiles.
- All bunkers were orderly and easily exploited, as were the revetments. This is in contrast to the other CEA Depots exploited. Multiple types of munitions were exploited, including air drop bombs, cluster bombs, Al Qa’ Qa’a 500 bombs, Al Fat’h missiles, tank munitions, rockets, surface-to-surface missiles, air-to-air missiles, RPGs, artillery projectiles of various caliber, and small arms. The majority of the munitions in the bunkers were stored in their original shipping containers.
- Munitions of interest were Iraqi Fuel Air Bombs and numerous Al Qa’ Qa’a 500 bombs along with several Al Fat’h Missiles.



*Figure 13. Hoover device.*



*Figure 14. Destroyed bunker.*



*Figure 15. 155mm smoke projectiles.*



**Figure 16.** Destroyed bunker.



**Figure 17.** 122-mm rockets.

- No WMD munitions were found (see Figures 17, 18, 19, and 20).

### **Jaguar CEA Depot**

Jaguar CEA Depot is located 300km NNW of Baghdad and 80km SSW of Mosul. The Jaguar North Depot contains 80 intact and 20 destroyed earth-covered bunkers, several revetments, and large quantities of open storage for munitions being received from northern Iraqi cache sites. Jaguar North comprises an area roughly 2.5 km by 5.5 km surrounded by a 6-foot fence and guard towers. Jaguar Depot is currently under the control of US Environmental, Inc. To the southwest roughly 5 km are two areas called Jaguar South and Jaguar Middle with a total of over 1,400 earthen revetments and 40 destroyed warehouses comprising an area of roughly 5 km by 6 km, surrounded by an earthen berm and concertina wire. More wire was in the process of being installed at Jaguar South. The warehouses at Jaguar South are severely damaged due to explosions from either Desert Storm or OIF.

- Multiple types of munitions were exploited by the team, including air drop bombs, cluster bombs, rockets, and air-to-air missiles. Large quantities of diverse munitions types were identified, including rockets, RPGs, artillery projectiles of various caliber, and small arms. The majority of the munitions in the bunkers were not stored in their original shipping containers. Most of the bunkers were unorganized, with propellant, powder bags, fuses,



**Figure 18.** Fuel air 500 bombs.



**Figure 19.** Examining Al Fath.



**Figure 20.** Assorted bombs.



**Figure 21.** 122-mm rockets.

and projectiles being intermixed with broken white plastic shipping containers and discarded wooden shipping crates piled on the floor. In contrast, some bunkers were well-organized, with munitions neatly stacked. All bunkers contained a large mix of conventional munitions that appeared to have been stored for an extended time, due to the amount of dust accumulated on the crates and munitions.

- At Jaguar South and Jaguar Middle the warehouses were all destroyed, causing Unexploded Ordnance (UXOs) to be scattered around the area by the explosions. Several of the warehouses had indications that looters burned material around the base of 155mm artillery projectiles in order to remove the brass rotating band. Presumably several of the explosions resulted from the looters' activities. Artillery projectiles with red and blue bands were found in an open area between revetments in the northwest corner of the ASP. Munitions were also found in a water-filled wadi on the north side of Jaguar South, outside the perimeter.
- Munitions of interest were 122mm rockets, CG-250 Cluster Bombs, and Spanish BRI-400 Bombs.
- No WMD munitions were found (see Figures 21, 22, 23, and 24).

### **Paladin CEA Depot**

Paladin CEA Depot is located 60km west of Baghdad. Munitions are shipped from central Iraqi cache sites. The Paladin Depot contains 51 intact earth covered bunkers, seven bunkers being described as large, two destroyed bunkers, hundreds of revetments, and open storage for captured enemy munitions received at this location. Paladin comprises an area roughly 4 km by 4 km surrounded by a 6ft fence and guard towers. The bunkers are located at the north corner, with the revetments scattered throughout the depot. Paladin Depot is currently under the operational control of EODT.

- The smaller bunkers were disorganized and the munitions were covered with dust and sand. Several types of munitions were exploited, including air drop bombs, cluster bombs, rockets, and surface-to-surface, surface-to-air, air-to-surface, and air-to-air missiles. Large quantities of artillery projectiles were found, of many types and various calibers: 20mm, 23mm, 30mm, 57mm, and 76mm projectiles were dispersed throughout the bunkers. One item of interest was a previously unseen 120mm smoke mortar projectile, later identified after searching DOD publications.
- The large bunkers were protected by a berm approximately 40 to 50 feet high. The front entrances had a drive through, and the bunkers featured an internal crane. An air handling system was incorporated into the side of the bunkers, suggest-



**Figure 22.** CG 250 cluster bomb with submunitions.



**Figure 23.** Spanish BRI 400 forefront.



**Figure 24.** Artillery projectiles.

ing that they once weapons that contain sensitive electronics and guidance systems. No indications were seen to indicate an air filtration system. These bunkers also had a central power junction shed (approximately 10-foot long, 6-foot wide, and 8-foot high). Some of the large bunkers held 122mm rockets, while others were empty.

- SA-2 missile containers were opened and the UN tag data was recorded for all SA-2s on site, with the exception of four that were physically inaccessible. The majority of these missiles were stored in their original shipping containers. One SA-2 was damaged and appeared to have been ejected from an exploded bunker.
- No al Samud or Al Fat'h missiles were identified, and no WMD munitions were found (see Figures 25, 26, 27, 28, 29, and 30).

#### **Taji CEA Depot**

Taji CEA Depot is located north of Baghdad and currently no longer accepts incoming munitions as a CEA Depot. This depot contains earth-bermed warehouses, roughly 100 of which are intact and roughly 20 damaged or destroyed. Munitions were shipped to this depot from caches within the Baghdad area of Iraq. Taji Depot comprises an area of approximately 5 km by 3 km surrounded by a 6-foot fence topped with several strands of barbed wire and guard towers. Some of the perimeter around the bomb and missile yard also has a 6- to 8-foot high berm, 10 to 20 meters from the fence line. The warehouses comprise most of the area of the depot, with the bomb and missile yard in the southeast corner. Taji Depot is currently under the operational control of EODT.

- Numerous revetments are located throughout the depot, most of which were filled with small arms munitions up to 57mm Anti-Aircraft Artillery. The open storage area south of the warehouses is referred to as the bomb and missile yard.
- Air deliverable bombs up to 500 kg, larger missiles up to and including FROGs, and surface-to-air missiles are stored in the open.



**Figure 25.** 3,000-kg bomb.



**Figure 26.** 120-mm mortar smoke munition.



**Figure 27.** Air to air missiles.



**Figure 28.** Hastily stacked SA-2 missiles.



**Figure 29.** Small bunker with lightning protection.



**Figure 30.** SA-2 and Roland missiles.



**Figure 31.** 262-mm rockets.



**Figure 32.** FROGs.



**Figure 33.** Incendiary bomb.



**Figure 34.** Fuel air bombs.

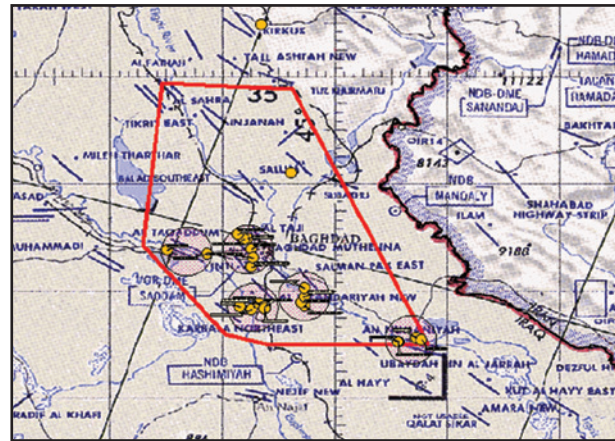
- The team exploited all missiles, rockets, and bombs in the open storage area and revetments within the bomb and missile yard. Surface-to-air missiles, rockets, and FROG missiles were neatly stacked. Multiple types of munitions were checked including airdrop bombs, cluster bombs, rockets, surface-to-surface missiles, surface-to-air missiles, and air-to-air missiles. The majority of SA-6 surface-to-air missiles were stored in their original shipping containers. The FROG missiles were stored in the open. A team also inspected eight Al Qa' Qa'a 250 bombs with the twisting weld—none of the Al Qa' Qa'a bombs were found with fill plugs.
- Taji will eventually contain only small arms ammunition (82mm and less).
- Munitions of interest were FROG missiles, 262mm rockets, Iraqi Fuel Air Bombs, cluster bombs, and Qa' Qa'a 250 Incendiary Bombs.
- No WMD munitions were found (see Figures 31, 32, 33, and 34).



## Annex I Review of 24 Iraqi Ammunition Supply Points

### Assessment of 24 Ammunition Sites Identified Within the Predetermined “Red Line”

ISG inspected Ammunition Supply Points (ASPs) and Captured Enemy Ammunition Points (CEAs) to determine whether caches of CW (chemical weapons) had been destroyed or were in storage. Iraq stockpiled or stored munitions at more than 10,000 sites. ISG chose to make use of the limited time available for inspection, focusing efforts on storage sites with the most potential for containing CW. In 2003, ISG formulated a methodology, beginning with sites near the so-called “Red Line” around Baghdad. (For information about the Red Line and its use in the defense of Baghdad, see Annex G). Of the 104 ASPs within the Red Line around Baghdad, ISG used indicators of CW—such as possible decontamination vehicles—to narrow the search to 24 sites. The results of that search—a single visit to each site that visually reviewed a majority



*Location of 26 RG ASPs near units capable of firing 155mm CW artillery shell or 122mm CW rockets and a suspect decontamination vehicle. The “red line” is shown for reference purposes.*

of the munitions on-site—were no caches of CW munitions and no single rounds of CW munitions. Although only a fraction of the hundreds of thousands of tons of Iraqi munitions were inspected, ISG has high confidence that there are no CW present in the Iraqi inventory.

Priority	Name	Coords
1	Kirkuk Bks FASP/Decon	352853N 0442124E
2	Margiabah FASP Taji South	332922N 0441355E
3	Shaykh Mazhar Barracks DIV and BDE HQ	325124N 0444432E
4	Margiabah Tactical FASP Southwest	332834N 0441209E
5	Al Musayyib BDE HQ A Ammo ORD Depot	324922N 0441559E
6	Iskandariyah Tactical FASP	325228N 0441941E
7	Ash Shuaybah (Zubayr) Ammo Stor Dpo East	302457N 0474151E
8	Shaykh Mazhar Tactical FASP	325316N 0444238E
9	Aradi Al Haswah Tactical FASP	332038N 0435227E
10	Abu Gharaib Revetment Field 1 SA-8 FASP	331313N 0441607E
11	Sabiat Tactical SAM FASP	332320N 0441613E
12	As Suwayrah Tactical FASP West	325610N 0444413E
13	Al Kut FASP Northwest	323325N 0454401E
14	Havy al Tayaran POL Depot and Storage Area	331828N 0441654E
15	Muhammed al Amir Tactical FASP	323126N 0453450E
16	Jurf al-Sakr FASP	325104N 0440954E
17	Ahmad al Husayn Tactical FASP	333125N 0440909E
18	Al Asriyah Tactical FASP South	325102N 0442300E
19	Muhammed al Amir Tactical FASP Southwest	323106N 0453417E
20	Saribadi Barracks Military Exchange	330126N 0444432E
21	Al Kut Barracks Northwest	323228N 0454629E
22	Al Haswah Tactical FASP South	324935N 0442318E
23	Al Miqdadiyah Ammo Depot	340550N 0443649E
24	Habbiniyah Ammo Depot	332221N 0433116E



# Biological Warfare

*I need these germs to be fixed on the missiles, and tell him to hit, because starting the 15th, everyone should be ready for the action to happen at anytime....*

*Saddam Husyan, January 1991*

*This page intentionally left blank.*

# Contents

Key Findings .....	1
Evolution of the Biological Warfare Program.....	5
The Regime Strategy and WMD Timeline .....	5
Evolution of the Biological Warfare Program .....	5
Ambition: The Early Years, 1960-1985.....	5
Renewed Ambition and Near-Realization: 1985-1991.....	8
The Beginning of the Decline: Opportunity Through Ambiguity and the End of the Game (1991-1996).....	11
Recovery and Transition 1996-2003.....	15
Research and Development.....	18
Building Human Capital.....	19
Research Facilities.....	20
Iraqi BW Agent Research.....	20
<i>Bacillus anthracis</i> ('Agent B') .....	20
<i>Clostridium botulinum</i> (Botulinum toxin, 'Agent A').....	21
<i>Clostridium perfringens</i> ('Agent G').....	22
Aflatoxin ('Agent C') .....	22
<i>Brucella</i> .....	22
Ricin .....	23
Wheat Cover Smut ('Agent D').....	25
Viruses.....	25
Camel Pox .....	27
Smallpox.....	28
Crimean Congo Hemorrhagic Fever .....	32
Acute Hemorrhagic Conjunctivitis (Enterovirus 70) .....	32
Rotavirus .....	32
Other R&D Related to BW Development .....	32
Biopesticides .....	32
Single Cell Protein R&D.....	34
Growth Media R&D.....	34
Drying Process/Carrier/Particle size.....	37
Production Capability .....	38
Break-Out Production Capability Pre-OIF.....	42
Mobile Assets .....	42

Weaponization.....	45
Attempts at BW Weaponization .....	47
The Gulf War .....	48
Concealment And Destruction of Biological Weapons.....	49
Iraq’s Initial WMD Concealment Effort.....	49
The Destruction of Iraq’s BW .....	50
What Remained Hidden and Undeclared 1995-1998? .....	53
Weaponization Related Activities in the Years Following Desert Storm.....	53
Unresolved Issues .....	56
Program Direction .....	56
Research and Development .....	56
IIS Laboratories .....	57
Seedstocks .....	57
Disposition of Iraq’s BW Program Culture Collection .....	57
Agent Production.....	57
Drying of BW Agents.....	58
Bacterial BW Agent Production and Storage .....	58
Weaponization .....	59

## **Annexes**

A. Bulk BW Agents .....	61
B. BW Research and Development Facilities .....	63
C. ISG Investigation of Iraq’s Reported Mobile Biological Warfare Agent Production Capability .....	73
D. Trailers Suspected of Being Mobil BW Agent Production Units .....	79

## Key Findings

*The Biological Warfare (BW) program was born of the Iraqi Intelligence Service (IIS) and this service retained its connections with the program either directly or indirectly throughout its existence.*

- The IIS provided the BW program with security and participated in biological research, probably for its own purposes, from the beginning of Iraq's BW effort in the early 1970s until the final days of Saddam Husayn's Regime.

*In 1991, Saddam Husayn regarded BW as an integral element of his arsenal of WMD weapons, and would have used it if the need arose.*

- At a meeting of the Iraqi leadership immediately prior to the Gulf war in 1991, Saddam Husayn personally authorized the use of BW weapons against Israel, Saudi Arabia and US forces. Although the exact nature of the circumstances that would trigger use was not spelled out, they would appear to be a threat to the leadership itself or the US resorting to “unconventional harmful types of weapons.”
- Saddam envisaged all-out use. For example, all Israeli cities were to be struck and all the BW weapons at his disposal were to be used. Saddam specified that the “many years” agents, presumably anthrax spores, were to be employed against his foes.

*ISG judges that Iraq's actions between 1991 and 1996 demonstrate that the state intended to preserve its BW capability and return to a steady, methodical progress toward a mature BW program when and if the opportunity arose.*

- ISG assesses that in 1991, Iraq clung to the objective of gaining war-winning weapons with the strategic intention of achieving the ability to project its power over much of the Middle East and beyond. Biological weapons were part of that plan. With an eye to the future and aiming to preserve some measure of its BW capability, Baghdad in the years immediately after Desert Storm sought to save what it could of its BW infrastructure and covertly continue BW research, hide evidence of that and earlier efforts, and dispose of its existing weapons stocks.
- From 1992 to 1994, Iraq greatly expanded the capability of its Al Hakam facility. Indigenously produced 5 cubic meter fermentors were installed, electrical and water utilities were expanded, and massive new construction to house its desired 50 cubic meter fermentors were completed.
- With the economy at rock bottom in late 1995, ISG judges that Baghdad abandoned its existing BW program in the belief that it constituted a potential embarrassment, whose discovery would undercut Baghdad's ability to reach its overarching goal of obtaining relief from UN sanctions.

*In practical terms, with the destruction of the Al Hakam facility, Iraq abandoned its ambition to obtain advanced BW weapons quickly. ISG found no direct evidence that Iraq, after 1996, had plans for a new BW program or was conducting BW-specific work for military purposes. Indeed, from the mid-1990s, despite evidence of continuing interest in nuclear and chemical weapons, there appears to be a complete absence of discussion or even interest in BW at the Presidential level.*

*Iraq would have faced great difficulty in re-establishing an effective BW agent production capability. Nevertheless, after 1996 Iraq still had a significant dual-use capability—some declared—readily useful for BW if the Regime chose to use it to pursue a BW program. Moreover, Iraq still possessed its most important BW asset, the scientific know-how of its BW cadre.*

- Any attempt to create a new BW program after 1996 would have encountered a range of major hurdles. The years following Desert Storm wrought a steady degradation of Iraq's industrial base: new equipment and spare parts for existing machinery became difficult and expensive to obtain, standards of maintenance

declined, staff could not receive training abroad, and foreign technical assistance was almost impossible to get. Additionally, Iraq's infrastructure and public utilities were crumbling. New large projects, particularly if they required special foreign equipment and expertise, would attract international attention. UN monitoring of dual-use facilities up to the end of 1998, made their use for clandestine purpose complicated and risk laden.

***Depending on its scale, Iraq could have re-established an elementary BW program within a few weeks to a few months of a decision to do so, but ISG discovered no indications that the Regime was pursuing such a course.***

- In spite of the difficulties noted above, a BW capability is technically the easiest WMD to attain. Although equipment and facilities were destroyed under UN supervision in 1996, Iraq retained technical BW know-how through the scientists that were involved in the former program. ISG has also identified civilian facilities and equipment in Iraq that have dual-use application that could be used for the production of agent.

***ISG judges that in 1991 and 1992, Iraq appears to have destroyed its undeclared stocks of BW weapons and probably destroyed remaining holdings of bulk BW agent. However ISG lacks evidence to document complete destruction. Iraq retained some BW-related seed stocks until their discovery after Operation Iraqi Freedom (OIF).***

- After the passage of UN Security Council Resolution (UNSCR) 687 in April 1991, Iraqi leaders decided not to declare the offensive BW program and in consequence ordered all evidence of the program erased. Iraq declared that BW program personnel sanitized the facilities and destroyed the weapons and their contents.
- Iraq declared the possession of 157 aerial bombs and 25 missile warheads containing BW agent. ISG assesses that the evidence for the original number of bombs is uncertain. ISG judges that Iraq clandestinely destroyed at least 132 bombs and 25 missiles. ISG continued the efforts of the UN at the destruction site but found no remnants of further weapons. This leaves the possibility that the fragments of up to 25 bombs may remain undiscovered. Of these, any that escaped destruction would probably now only contain degraded agent.
- ISG does not have a clear account of bulk agent destruction. Official Iraqi sources and BW personnel, state that Al Hakam staff destroyed stocks of bulk agent in mid 1991. However, the same personnel admit concealing details of the movement and destruction of bulk BW agent in the first half of 1991. Iraq continued to present information known to be untrue to the UN up to OIF. Those involved did not reveal this until several months after the conflict.
- Dr. Rihab Rashid Taha Al 'Azzawi, head of the bacterial program claims she retained BW seed stocks until early 1992 when she destroyed them. ISG has not found a means of verifying this. Some seed stocks were retained by another Iraqi official until 2003 when they were recovered by ISG.

***ISG is aware of BW-applicable research since 1996, but ISG judges it was not conducted in connection with a BW program.***

- ISG has uncovered no evidence of illicit research conducted into BW agents by universities or research organizations.
- The work conducted on a biopesticide (*Bacillus thuringiensis*) at Al Hakam until 1995 would serve to maintain the basic skills required by scientists to produce and dry anthrax spores (*Bacillus anthracis*) but ISG has not discovered evidence suggesting this was the Regime's intention. However in 1991, research and production on biopesticide and single cell protein (SCP) was selected by Iraq to provide cover for Al Hakam's role in Iraq's BW program. Similar work conducted at the Tuwaita Agricultural and Biological Research Center (TABRC) up to OIF also maintained skills that were applicable to BW, but again, ISG found no evidence to suggest that this was the intention.



- Similarly, ISG found no information to indicate that the work carried out by TABRC into Single Cell Protein (SCP) was a cover story for continuing research into the production of BW agents, such as *C. botulinum* and *B. anthracis*, after the destruction of Al Hakam through to OIF.
- TABRC conducted research and development (R&D) programs to enable indigenous manufacture of bacterial growth media. Although these media are suitable for the bulk production of BW agents, ISG has found no evidence to indicate that their development and testing were specifically for this purpose.
- Although Iraq had the basic capability to work with variola major (smallpox), ISG found no evidence that it retained any stocks of smallpox or actively conducted research into this agent for BW intentions.

***The IIS had a series of laboratories that conducted biological work including research into BW agents for assassination purposes until the mid-1990s. ISG has not been able to establish the scope and nature of the work at these laboratories or determine whether any of the work was related to military development of BW agent.***

- The security services operated a series of laboratories in the Baghdad area. Iraq should have declared these facilities and their equipment to the UN, but they did not. Neither the UN Special Commission (UNSCOM) nor the UN Monitoring, Verification, and Inspection Commission (UNMOVIC) were aware of their existence or inspected them.
- Some of the laboratories possessed equipment capable of supporting research into BW agents for military purposes, but ISG does not know whether this occurred although there is no evidence of it. The laboratories were probably the successors of the Al Salman facility, located three kilometers south of Salman Pak, which was destroyed in 1991, and they carried on many of the same activities, including forensic work.
- Under the aegis of the intelligence service, a secretive team developed assassination instruments using poisons or toxins for the Iraqi state. A small group of scientists, doctors and technicians conducted secret experiments on human beings, resulting in their deaths. The aim was probably the development of poisons, including ricin and aflatoxin to eliminate or debilitate the Regime's opponents. It appears that testing on humans continued until the mid 1990s. There is no evidence to link these tests with the development of BW agents for military use.

***In spite of exhaustive investigation, ISG found no evidence that Iraq possessed, or was developing BW agent production systems mounted on road vehicles or railway wagons.***

- Prior to OIF there was information indicating Iraq had planned and built a breakout BW capability, in the form of a set of mobile production units, capable of producing BW agent at short notice in sufficient quantities to weaponize. Although ISG has conducted a thorough investigation of every aspect of this information, it has not found any equipment suitable for such a program, nor has ISG positively identified any sites. No documents have been uncovered. Interviews with individuals suspected of involvement have all proved negative.
- ISG harbors severe doubts about the source's credibility in regards to the breakout program.
- ISG thoroughly examined two trailers captured in 2003, suspected of being mobile BW agent production units, and investigated the associated evidence. ISG judges that its Iraqi makers almost certainly designed and built the equipment exclusively for the generation of hydrogen. It is impractical to use the equipment for the production and weaponization of BW agent. ISG judges that it cannot therefore be part of any BW program.

*This page intentionally left blank.*

## Evolution of the Biological Warfare Program

### The Regime Strategy and WMD Timeline

*For an overview of Iraqi WMD programs and policy choices, readers should consult the Regime Strategy and WMD Timeline chart, enclosed as a separate foldout and in tabular form at the back of Volume I. Covering the period from 1980-2003, the timeline shows specific events bearing on the Regime's efforts in the BW, CW, delivery systems and nuclear realms and their chronological relationship with political and military developments that had direct bearing on the Regime's policy choices.*

*Readers should also be aware that, at the conclusion of each volume of text, ISG has included a foldout summary chart that relate, inflection points—critical turning points in the Regime's WMD policymaking—to particular events, initiatives, or decisions the Regime took with respect to specific WMD programs. Inflection points are marked in the margins of the text with a gray triangle.*



### Evolution of the Biological Warfare Program

*For more than 20 years Iraq pursued a program of secret research, development and production in a bid to acquire a BW capability with which to defend its interests and project its influence beyond Iraq's borders. A well-kept secret known to only a handful of leaders, Iraq's BW program—approved by Saddam Husayn, overseen by Husayn Kamil Hasan Al Majid, guided by Dr. 'Amir Hamudi Hasan Al Sa'adi, and closely linked to the IIS—culminated in the first Gulf war in January 1991, by which point Iraq had developed a small but impressive arsenal of BW weapons comprising over 100 bombs, at least 25 Al Husayn warheads filled with anthrax spores, botulinum toxin and aflatoxin, as well as many thousands of liters of these agents stored in bulk, for use in Iraq's unsophisticated delivery systems. Iraq's BW infrastructure emerged from that conflict damaged,*

but not destroyed, and the in the wake of the war the Regime tried to preserve what it could of its BW program. Aiming to leave open the option of restarting BW activities once UN inspections were over and sanctions were lifted, Baghdad attempted to remove all possible signatures of its past offensive activities. Simultaneously, Iraq undertook a significant denial and deception effort intended to conceal from the UN the true nature, scope, and ultimate objectives of the program. By 1995, these efforts had failed, and Iraq admitted its offensive program, leading in 1996 to the destruction, at Saddam's orders and under UN supervision, of most of the Iraq's BW physical infrastructure.

*The destruction of the BW infrastructure in the mid-1990s halted Iraq's BW activities, with the exception of its efforts to preserve intellectual know-how, the Regime's most valuable asset. BW programs are primarily the product of trained innovative scientific minds. Extensive scientific laboratories and vast industrial complexes are unnecessary. A handful of dedicated, bright scientists, supported by dexterous, intelligent, and experienced technicians working with simple but effective equipment, materials, and animals in a secure environment can accomplish most of what is required to lay the foundations of a BW program. In comparison to nuclear and chemical weapons (CW) programs, individuals' intellectual capabilities play a far greater role in determining the success or failure of a program than the physical resources to which they may have access. Thus, any account of Iraq's BW program is largely a story of the key experts who are involved, and only secondarily a history of facilities and equipment (see Figure 1).*

### Ambition: The Early Years, 1960-1985.

*Iraq's first foray into chemical and biological warfare (CBW) was rooted in the nationalist wave that swept the Middle East in the 1960s under Egypt's president, Gamal Abdul Nasser, when Arab military leaders concluded the time had come to increase their understanding of the technology of modern warfare. Select junior officers in Iraq's armed forces traveled overseas for CBW training, among them Lt.*



Nizar Al Attar, who attended the CBW courses at Fort McClellan in the US and was later to head Iraq's CW program and introduce BW to Al Muthanna State Establishment (MSE). In 1964, the Iraqi Army established a Chemical Corps, thus taking the first step that led to the acquisition of CBW. Following the Ba'thist revolution of 17 July 1968 that brought Ahmad Hasan Al Bakr to power, senior army officers, encouraged by their technologically aware subordinates, decided to embark on a CW program. It was an amateur affair consisting of small groups trying to develop agent. By the early 1970s, the attempt had failed.

In 1974, a charismatic officer, Ghassan Ibrahim founded a laboratory, nominally a respectable academic body run by the Ministry of Higher Education and Scientific Research carrying out legitimate scientific research, named the Al Hasan Ibn-al-Haytham [Al Hazen Ibn-al-Haithem] Research Institute (see Figure 2). In reality, the institute was a front for clandestine activity in CW, BW, electronics, and optics under the patronage of the IIS. Ibrahim's assistant was an intelligence officer, Fa'iz 'Abdallah Al Shahin, who would later oversee Iraq's production of CW agents during the Iran-Iraq war and play a key role in the development of other nonconventional weapons, such as radiological bombs. He would also briefly supervise part of the BW program. Later still, Fa'iz would become Deputy Minister of Oil.

Al Hasan was a large, coordinated effort to master the technologies associated with several aspects of modern warfare. Quickly Al Hasan established chemical laboratories at Al Rashad, NE of Baghdad, posing as 'The Center for Medical Diagnostics' and a temporary biological center in the Al 'Amiriyah suburb of Baghdad. A purpose built closed-institute soon followed: the Ibn-Sina Center at Al Salman occupying a peninsula formed by the River Tigris 30km south of Baghdad. The Ibn-Sina Center masqueraded as 'The Center for Medical Agriculture'. After occupying a temporary headquarters in Sadun Street in the center of Baghdad, Al Hasan built a new headquarters and physics laboratory at Masbah nearby and later added an electronics laboratory at Tajiyat, north of Baghdad.

The generation of scientists trained and employed at Al Hasan, many of whom devoted more than 20 years of their careers to the pursuit of WMD, formed the backbone of Iraq's later CW and BW programs. Ini-

tially, a group of nine scientists drawn from the Ministries of Higher Education, Defense and Health led the original offensive BW effort, conducting research into bacteria, toxins, and viruses, emphasizing production, pathogenicity, dissemination and storage of agents, such as *Clostridium botulinum*, spores of *Bacillus anthracis*, cholera, polio, and influenza virus. Later, in both chemical and biological disciplines, the Al Hasan Institute engaged prominent scientists to train and guide more junior staff and chemical corps officers. Dr. Muhammad 'Abd-al-Mun'im Al Azmirli, an Egyptian, mentored the chemists and Dr. Muzhir [Mudher, Modher] Al Falluji led the biologists. The Institute sponsored its staff to study abroad for PhDs in subjects appropriate for the CW or BW effort. The Iraqi Regime rewarded success with promotion, high status, money, and material goods.

The second attempt to develop BW also faltered despite considerable effort. The Minister of Defense and Dr. 'Amir Al Sa'adi concluded in a 1978 investigation that Al Hasan had failed to deliver what it promised and that there had been academic and financial fraud. Arrests and imprisonment of several researchers followed for fraud and embezzlement surrounding the purported development of influenza as a BW agent. Al Sa'adi decided that project was a failure, not having made enough progress toward industrial scale BW production and should be shut down, which the Iraqi government did on 16 January 1979, exactly 6 months before President Ahmad Hasan Al Bakr resigned in favor of his Vice President, Saddam Husayn. The facilities and staff were parceled out to various government establishments such as State Organization for Technical Industries (SOTI). The best personnel went to the IIS. Between 1979 and 1985, Iraq rebuilt and expanded the dual-use infrastructure for BW research, but undertook little work of significance.

- In 1979, a presidential decree created the Scientific and Technical Research Directorate (STRD) which later became the Technical Research Center (TRC), as a technical support agency for the IIS and to replace the Al Hasan as a cover mechanism for continued work on the development of chemical and biological agents.

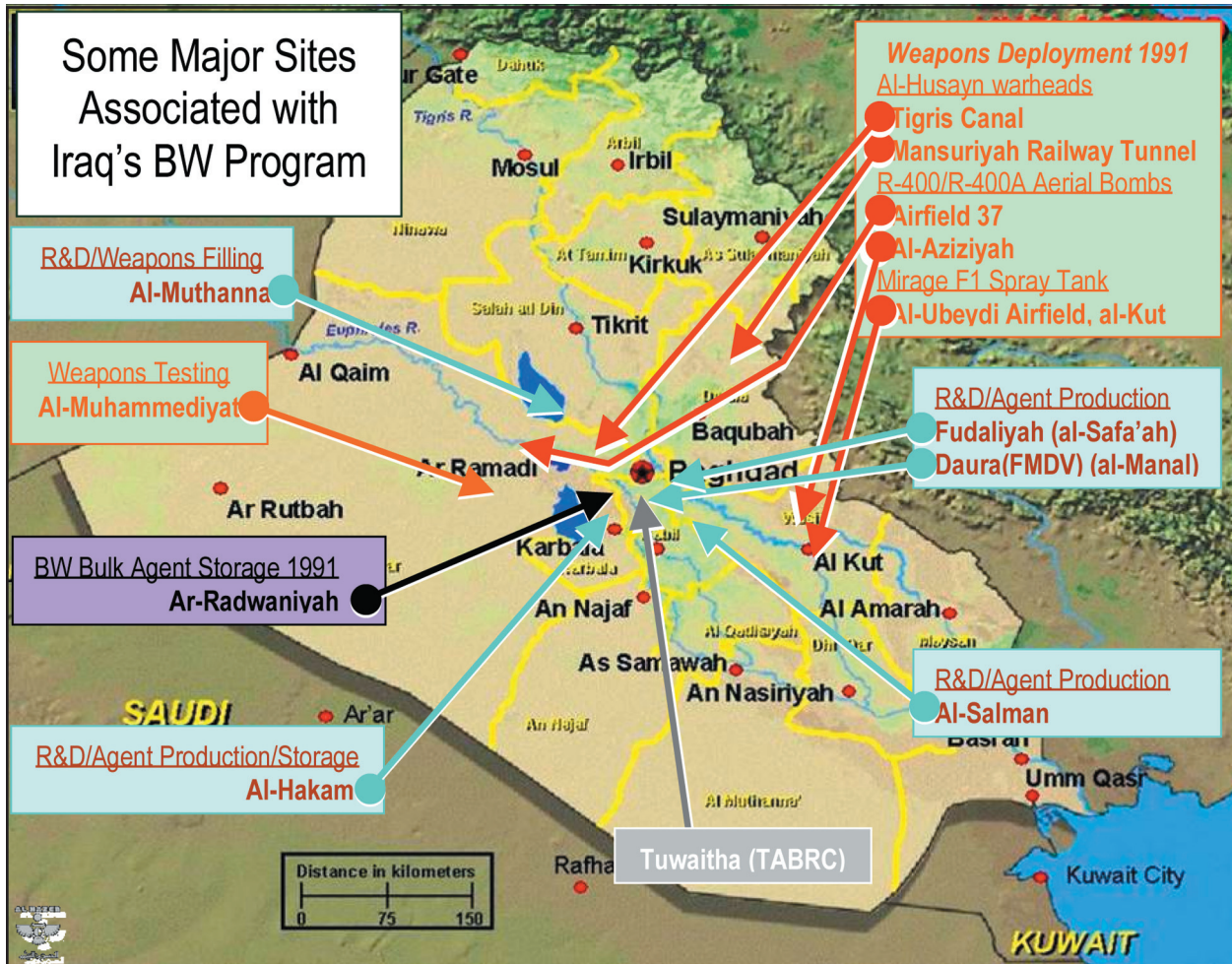



Figure 1. Some major sites associated with Iraq's BW Program.



Figure 2. Al Hazen emblem.

- The IIS continued small-scale CBW activities, recruiting chemists and scientists from universities and private laboratories and assigning them to Al Salman to conduct research.
- In 1983, a militarily relevant BW program restarted at the CW facility at Al Muthanna. UN inspectors were told that the initiative for this came from the Director General (DG) of Al Muthanna, Lt. Gen. Nizar Al Attar, who then received endorsement from the Minister of Defense. ISG has been unable to establish the veracity of this story, although it is apparent that a BW program started there in 1984 under the auspices of the MOD, funded by the State Organization for Technical Industries (SOTI), and headed at the research level by a new recruit, Dr. Rihab. Her direction, at least at the working level, was at this time given by Lt. Gen. Nizar who instructed her that he “*did not want research to put on a shelf. He wanted applied research to put in a bomb.*”

#### **Renewed Ambition and Near-Realization: 1985-1991**

 ***The outbreak of the Iran-Iraq war in 1980 altered Baghdad's perception of the value of WMD and led to a reinvigoration of the BW program.*** In the view of Iraqi leaders, Iraq's CW halted Iranian ground offensives and ballistic missile attacks on Tehran broke its political will.

- According to Brig. Dr. Mahmud Farraj Bilal Al Samarra'i, Iraq's war with Iran was the catalyst to reactivate Iraq's BW efforts. Iraq's success with CW during its war with Iran only reaffirmed the potential value of unconventional capabilities like BW. He opined that, “if the Iran war lasted beyond 1988, Saddam would have used BW.” Further, Iraq's concerns about Israel and their WMD capabilities provided additional impetus to seek a strategic counterbalance to deter foreign threats.
- Dr. Bilal added additional perspectives on the strategic intent of Iraqi's BW program, which he described as a strategic capability that would

compliment Iraq's CW efforts with great potential for achieving surprise. Bilal also commented that Iraq considered BW a potential counterbalance to the Israeli threat, but acknowledged that Iraq lacked an effective delivery system to mount a BW attack against Israel.

- After the outbreak of the Iran-Iraq war, one of the country's most eminent microbiologists and one of its few experts in fermentation, Professor Nassir Al Hindawi of Mustansiriyah University, submitted a proposal for BW research to the Presidential Diwan. The leadership directed his proposal to Lt. Gen. Nizar, the DG of Al Muthanna. Al Hindawi convinced Saddam to utilize disease-causing agents to aid the war effort against Iran. The focus of his interest was developing botulinum toxin as tactical nerve-like BW agent and anthrax as a strategic and tactical weapon.

***In the early 1980s Baghdad stepped up the pace of its BW program significantly.*** In 1983, the remnants of the first BW effort became formally part of Al Muthanna under the direction of Lt. Gen. Nizar Al Attar. According to UNSCOM reporting, a formal research plan was drafted that year committing to BW research. Meanwhile, close by at the old facilities of the Al Hasan Institute, Al Salman was conducting a parallel BW research program under the authority of the intelligence services that included research into an anti-crop fungal agent, *Tilletia*, and the development of a bacterial spray device (known as the Zubaydi device, after its inventor). Al Salman tested the spray device, mounted on a helicopter, with reportedly inconclusive results, at Khan Bani Sa'ad in August 1988.

In late 1984, on returning from completing her PhD in the UK, Dr. Rihab was contacted by Lt. Gen. Nizar and directed to report to Al Muthanna, where she took over technical leadership of the BW program and led it to a series of achievements. ***According to Dr. Rihab, in 1983, there was an informal decision made to revitalize the BW program. Three years later, a 5-year plan was drawn up that would lead to BW weaponization,*** a course Dr. Rihab and her group implemented with urgency, authority, and great secrecy demonstrating considerable planning. Dr.

Rihab formed a team and commenced extensive literature surveys, based initially on the citation indices of the Stockholm Peace Research Institute (SIPRI) publications of the 1960 and 1970s. The team also started conducting toxicological investigations. Under her leadership of the technical elements, the program moved steadily through a series of discrete phases.

- In 1985, Dr. Rihab ordered reference strains of several pathogenic organisms from a variety of foreign sources and began basic research on candidate BW agents. Al Hindawi became an advisor to her in 1986.
- In 1986, under the guise of work at Baghdad University, she successfully ordered multiple isolates of pathogens from the American Type Culture Collection (ATCC), such as *B. anthracis* for use in the early BW agent research effort.
- In 1987, the program moved from Al Muthanna to Al Salman. The group now under the control of Ahmad Murtada, DG of the TRC, recruited new staff and broadened its range of agents. Murtada was an acolyte of Husayn Kamil and relied on the Military Industrialization Commission (MIC) and its Senior Deputy, Dr. 'Amir Al Sa'adi, for the weapons aspects of the program. Equipment from the At Taji SCP Plant was transferred to Al Salman in August that year.
- Also in 1987, Dr. Rihab and Dr. 'Amir Al Sa'adi discussed the possibility of developing a transportable system for the production of BW agents. She claims that the idea was largely 'Amir Al Sa'adi's and that she rejected the proposal in favor of a fixed production site at Al Hakam.
- In 1988, they opened the facility at Al Hakam. Production of anthrax, botulinum toxin and *Clostridium perfringens* started. Weapon development and testing followed.
- In May 1988, TRC broadened the base of the BW program by adding a mycologist, Dr. 'Imad Dhiyab, with a team that researched fungal toxins, including trichothecene mycotoxins and later aflatoxin. The connection, if any, of this work with the earlier fungal work at Al Salman, is unknown.

- When Iraq tried to expand the production capacity of Al Hakam by importing three 5 cubic meter fermentation vessels from the Swiss company Chemap in 1988, the export license was denied; this, despite implementing an elaborate deception plan involving a fake production building at Al Qa'qa'a. However, fermentors and other equipment were requisitioned from an Iraqi veterinary vaccine plant at Al Kindi and transferred to Al Hakam in November 1988.
- In 1989, Dr. Rihab sought to have a spray dryer manufactured in Iraq for work at Al Hakam. Iraqi companies were able to fabricate the body of a dryer but not the other components. In fact, there was already a dryer at Al Hakam that would, with some safety modifications, have been suitable for drying BW agent. This dryer had been transferred from the At Taji SCP Plant to Al Hakam in 1988. Nevertheless, she sought from overseas a commercial dryer that could, without modification, safely dry anthrax. In 1989, Iraq approached a foreign manufacturer of dryers with a sample of *Bacillus thuringiensis* (Bt) to be dried for biopesticide purposes as a cover for the true purpose. The company did not supply Iraq with the special dryer.

**By early 1990, Iraq was methodically advancing toward the acquisition of a BW component to its arsenal of WMD.** Iraq had conducted laboratory and environmental static and dynamic explosive field tests of wheat cover smut, aflatoxin, anthrax simulants (*Bacillus subtilis* and *thuringiensis*), botulinum toxin, *Clostridium perfringens* and ricin. Following Saddam Husayn's speech on 2 April 1990 that identified Israel as a threat, Husayn Kamil ordered the BW program to go all out for weaponization. The program took on a sudden urgency and its direction changed dramatically; frenetic and convulsive efforts to adapt new weapons and acquire and expand BW agent production replaced the years of orderly progress.

**By the time of Iraq's invasion of Kuwait on 2 August 1990,** the BW program had moved into high gear with the aim of fielding filled weapons as quickly as possible. Also in August 1990, Al Hakam commenced production of *Clostridium perfringens*, the causative agent of gas gangrene. There is no evidence of the weaponization of this material and details of its disposal remain uncertain.



- Botulinum toxin and anthrax were the backbone of the Iraqi pre-1991 BW program. In addition to the production activities at Al Hakam, the Foot and Mouth Disease Vaccine plant (FMDV) at Al Dawrah was adapted for the production of botulinum toxin and continued to produce the agent until they evacuated the site on 15 January 1991, two days before the start of Desert Storm. While senior Iraqi officials deny production of anthrax at FMDV, the UN found traces of anthrax on two fermentors and a mobile storage tank in the facility. One source has informed ISG that the site did produce anthrax. ISG concludes that FMDV produced anthrax. ISG does not know whether the fate of this anthrax was the same as that produced at Al Hakam.
- Dr. Hazim 'Ali, recruited in July 1990 to lead the development of viral agents, took over the FMDV Plant at Al Dawrah in September of that year, renaming it 'Al Manal'. He commenced work on viruses including hemorrhagic conjunctivitis, human rotavirus, and camel pox with a view to weaponization. Hazim's viral work was still in its infancy by the time of Desert Storm and very little had actually been achieved.

*In parallel with the production of BW agents, other facilities were manufacturing R-400 aerial bombs and warheads for the Al Husayn missile.* Husayn Kamil had the final say over which agents to weaponize. Although in November 1990, Al Muthanna started adapting an aircraft auxiliary fuel tank as a means of dispersing BW agent, a few days after the invasion of Kuwait, Husayn Kamil chose to use the R-400 aerial bomb and the Al Husayn missile warhead because they were already in use for CW agents. There was no discussion of how to weaponize BW agents because of lack of time and the pressing need to make decisions quickly. Additional weapons testing of R-400 bombs using an anthrax simulant, *B. subtilis*, occurred leading up to the war. In addition, there is an unconfirmed report that Bt was used in explosive testing of an unidentified BW munition at Al Hakam between September 1990 and January 1991.

- In November 1990, Al Muthanna started adapting an aircraft auxiliary fuel tank as a means of dispersing BW agents. Iraq had previously attempted a

similar development in the CW field and in a letter, dated 10 December 1990, to Husayn Kamil, Gen. Fa'iz Shahin, DG of Al Muthanna, had referred to "successful tests of spraying mustard gas by planes which proved to be very effective." It appears that the BW spray device was a continuation of this earlier effort. Sometime in early January 1991, at a meeting of the Iraqi leadership, Husayn Kamil told Saddam: "Sir, the best way to transport this weapon (BW) and achieve the most harmful effects would come by using planes, like a crop duster, to scatter it. This is, Sir, a thousand times more harmful." Saddam responded that he wanted all options of delivering BW agent to the targets. The Iraqi Air Force flew the tanks with anthrax simulants to optimize the dispersion characteristics. The Air Force also experimented with a remotely piloted MiG-21 aircraft as a possible delivery platform for a similar tank system. These trials only ceased when Desert Storm started.

*By January 1991, reflecting the huge exertion of the previous months, Iraq had produced large quantities of anthrax, botulinum toxin, Clostridium perfringens, aflatoxin, and small quantities of ricin, and had more than 180 BW weapons deployed to five hide sites. In addition, Al Hakam protected caches of bulk BW agent containers by moving them from site to site during the hostilities. The weapons and agent were guarded and ready for use. The Iraqi leadership decided policy for their use and targeting. Iraq states that the opening bombardment of 17 January 1991 destroyed the only aircraft and spray tank ready for use. Despite this, work continued to complete another three tanks, with plans for a further eight in preparation.*

- Iraq had filled ballistic missiles and aerial bombs, and was modifying aircraft fuel tanks to spray BW agents.
- The weapons, though not agent production, were not well designed technically and the result of an immature development program. In ISG's view, the weapons were suboptimal but could have been effective in certain circumstances.



- The Iraqis were well aware of the shortcomings of the Al Husayn missile and the R-400. Lt. Gen. Hazim, commander of the Surface-to-Surface Missile Forces openly admitted that the Al Husayn, with a BW agent filled warhead, would fulfill its purpose if after impact in an enemy country sufficient material survived to enable its detection as a BW agent. It was a weapon of terror. They were for use in extremis and only if an enemy directly threatened the existence of the Regime in its heartland in and around Baghdad. Except for those *in the know*, Iraqi armed forces treated BW weapons as ‘special chemical’, a more toxic type of CW weapon.

***Saddam himself exercised control over Iraq’s BW arsenal, and he was prepared to use it against US and allied forces in the event of war. At a meeting in early January 1991, he identified the targets for the BW weapons. Israel was to be first and all Israeli cities were targets, but he ordered that strikes concentrate on Tel Aviv. US forces were to be targets if they attacked with unconventional forces. He also identified Riyadh and Jeddah as targets. In a transcript of discussions held at the time Saddam ordered the use of the more persistent (presumably anthrax) BW agents: “we want the long term, the many years kind.”***

- Saddam envisaged all out use of the weapons. He said “*we don’t want to depend on one option*” and that Iraqi forces must use all means, bombs, missiles and spray aircraft, to deliver the BW agent. He pointed out that this was “*a life and death issue and all the orders about targets are sealed in writing and authenticated*” in case something happened to him.
- The stockpiles of weapons and bulk agents remained in their hide sites unused and undamaged. Two officials shared the day-to-day responsibility; Dr. Bilal for the bombs and missiles and Dr. Rihab for the bulk BW agent.

### **The Beginning of the Decline: Opportunity Through Ambiguity and the End of the Game (1991-1996)**

***ISG assesses that in 1991, Iraq clung to the objective of gaining war-winning weapons with strategic intent that would enable the projection of its power over much of the Middle East and beyond. BW was part of that plan. With an eye to the future and aiming to preserve some measure of its BW capability, Baghdad in the years immediately after Desert Storm sought to save what it could of its BW infrastructure, hide evidence of the program, and dispose of its existing weapons stocks.*** Following Baghdad’s formal acceptance of UNSCR 687 of 3 April 1991, Iraq had 15 days to declare its stocks of WMD. ***It did not do so, and in a letter dated 18 April 1991, to the Secretary General of the UN, Foreign Minister Tariq Aziz even denied that Iraq had any BW program.*** Baghdad’s action in the following months and years indicate that it intended to preserve its BW capability and return to the steady, methodical progress toward a mature BW capability when inspections ended and sanctions were lifted. The biopesticide program that was established after the 1991 Gulf war, temporarily preserved Iraq’s research, development and production base at Al Hakam and, whether intentionally or otherwise, achieved several objectives set out in the original Iraqi BW strategic plan drafted in 1985. These included industrial-scale production of biological agents, albeit nonpathogenic ones, and perfecting development of dry agent formulation.

***Baghdad took early steps to protect what remained of the BW physical plant and equipment.*** During the first Gulf war, the only facilities directly relevant to Iraq’s BW program that were destroyed were the research laboratories at Al Salman and the munitions filling station at Al Muthanna. Neither was critical to the BW program that was centered on Al Hakam. Al Hakam at that time was unknown to the Coalition and therefore was not attacked during the war, unlike the Abu Ghurayb Infant Formula Plant (the *Baby Milk Factory*) that the Coalition destroyed by bombing in the mistaken belief that it was a key BW facility. ***Following approval of UNSCR 687 in early April 1991, Saddam Husayn endorsed Husayn Kamil’s decision not to declare Al Hakam as part***

*of the BW program* and decided to convert the plant to commercial use prior to the arrival of the second UNSCOM BW team in September 1991. Husayn Kamil pressured Dr. Rihab to complete this transition quickly to save equipment and the jobs of the scientists and technicians.

- Saddam wanted to keep scientists employed, according to ‘Amir Muhammad Rashid Al ‘Ubaydi. Moreover, he initially expected the sanctions would last no more than three years, and many Iraqis doubted the sanctions would be so comprehensive, according to several interviews with former officials. These perceptions probably persuaded senior Regime leaders that they could weather a short-lived sanctions regime by making limited concessions, hiding much of their pre-existing weapons and documentation, and even expanding BW potential by enhancing dual-use facilities.

***The advent of postwar UN inspections posed serious problems for Iraq, and in a bid to hide the true uses of the remaining plant and equipment the Regime ordered a large scale deception effort, involving cleaning existing plants to remove traces of BW activity, hiding relevant documents, destroying existing stocks of agent, and concocting a cover story for ongoing BW-related work at Al Hakam.*** Immediately Iraq scoured the principal facilities to remove evidence of an offensive BW program. The production plant was vigorously decontaminated, research papers altered, evidence hidden or destroyed and the BW cadre agreed to provide false accounts of past events and future intent. In the summer of 1991, on the orders of Husayn Kamil relayed through Ahmad Murtada, Dr. Rihab ordered that all documents associated with the BW program be destroyed and all production activities at Al Hakam be stopped. She claims to have collected all documents, kept a few, and destroyed or buried the rest. She ordered all BW scientists from Al Salman and Al Hakam to sign a legal document stipulating, under the threat of execution, a prohibition on speaking to UN inspectors about the production of, or progress on, any BW agent.

- After that order, the person in charge of physical security at Al Hakam witnessed Dr. Rihab remove about 20 to 25 electronic media disks (floppy disks) from her office.

- In late 1991, Saddam Husayn’s Secretary, ‘Abd Hamid Mahmud Al Khatab Al Tikriti, asked Husayn Kamil if Iraq would declare the BW program to the UN. Husayn Kamil indicated that it would not be necessary and he would order the scientists to hide all evidence of the program in their homes. Husayn Kamil arranged the collection of all documents relating to WMD and directed the Special Security Organization (SSO) to conceal them. This was to facilitate the reconstitution of WMD programs after the UN departed. There is some uncertainty whether these documents are the same as those handed to the UN in 1995 from Husayn Kamil’s chicken farm.

***Saddam also authorized Husayn Kamil to destroy, unilaterally, Iraq’s stocks of BW agents.*** There were three distinct phases of destruction, including clean up and sterilization of facilities including Al Salman, Al Hakam, Al Manal and Al Safa’ah; destruction of munitions by TRC and Al Muthanna personnel; and neutralization and dumping of bulk BW agent. According to some accounts given by former Iraqi officials, the clean up of the Al Hakam site began in May 1991. Other accounts give the order as sometime in the summer of 1991. In any case, Dr. Rihab ordered MIC to sanitize Al Hakam to destroy any traces of botulinum toxin and anthrax. The Al Hakam site was sanitized, which entailed the sanitization of all surfaces, drains, equipment and sewers using formalin, alcohol and potassium permanganate.

***ISG, however, continues to harbor doubts regarding Iraq’s destruction of bacterial reference strains and isolates.*** According to Dr. Rihab, she destroyed these materials in early 1992, but ISG can verify neither that the materials were destroyed nor the other details of Dr. Rihab’s account. She maintains that she gave a small box containing no more than 25 vials of lyophilized bacterial pathogens, including those obtained from the American Type Culture Collection to the IIS in mid-1991 for safekeeping. Allegedly, Husam Muhammad Amin Al Yasin, who would eventually become the director of the National Monitoring Directorate (NMD), returned the box to her in early 1992. She also claimed that she asked former TRC head Ahmad Murtada what to do with the vials. Murtada took the matter to Husayn Kamil,



who ordered the vials destroyed. Dr. Rihab claims she did this by injecting the vials with Dettol™ and then autoclaving the vials. According to UNSCOM data, all ATCC ampules were accounted for and there should have been no remaining unopened vials from ATCC after the first UNSCOM BW inspection.

***ISG judges the Regime took these steps with the aim of restarting the BW program in the future.*** In 1993, Husayn Kamil reportedly announced in a speech to WMD scientists that Iraq's WMD programs would resume and expand when UN inspectors left. Al Hindawi recounted to ISG a conversation he had with 'Amir Al Sa'adi about the future of the BW program following the first Gulf war. Al Sa'adi referred to Husayn Kamil's intent as "His Highness had a broad vision of the future." Al Hindawi interpreted this to mean that Husayn Kamil intended to reactivate the program later.

***Even as Baghdad took steps to hide its remaining BW infrastructure and cover the traces of its previous program, the Regime sought to continue a covert BW development effort under the cover of civilian research.*** In April 1991, Dr. Rihab personally briefed Saddam Husayn on the plan to convert Al Hakam for the production of biopesticide. In that same month, MIC and Saddam Husayn decided to develop programs for SCP and biopesticide, using Bt as the cover.

- Dr. Bilal told ISG, "Al Hakam was kept as potential for the BW program in the future." He described that they decided they must do everything to preserve it and stated that the entire bio-insecticide and SCP effort at Al Hakam was a "100% cover story" created by 'Amir Rashid. Dr. Rihab also stated that the intent to produce the SCP and bioinsecticide Bt at Al Hakam was "to cover the equipment."

***ISG judges that in the wake of Desert Storm and destruction of much of the BW effort, Iraq's strategic objective was to give the appearance of cooperating with UNSCOM while preserving the intellectual capital amassed in prior years on BW.*** The Bt and SCP programs offered an effective justification that allowed Iraq to keep the Al Hakam site with its extensive equipment and skilled scientists in one place. Dr. Bilal related that after they created the cover story for

Al Hakam, an economic study of Single Cell Protein (SCP) was conducted highlighting that Al Hakam's production capacity was only kilograms while Iraq's calculated "legitimate" SCP need was 70 tonnes per year.

- Nasr Al Hindawi advocated the development of SCP at Al Hakam. The idea was endorsed because of his reputation in SCP production that was expected to provide credibility for the program to outside observers. Using SCP as an alternative feedstock, however, required very large rates of annual production (hundreds of tonnes) as well as large quantities of scarce methanol and ethanol for growth media.
- Dr. Rihab was not interested in SCP. The production of Bt pesticides was a convenient cover. The assertion that Al Hakam had been involved in biopesticide production before 1991 provided what they hoped to be a plausible explanation that enabled Iraq to avoid declaring production of anthrax. She enlisted the support of Dr. Jabbar Farhan 'Abd-al-Razzaq Al Ma'dhihi from the TABRC who had conducted research on Bt to assist in the development of biopesticide production.

Ostensible biopesticide production at Al Hakam required both an expansion of the facilities and collaboration with the IAEC's TABRC. The cover story did not fit the limited capabilities that resided at Al Hakam: the production capacity of the plant was far too little to be convincing that it really was for commercial SCP purposes. Realizing this, Baghdad began to expand production capacity in 1993. Simultaneously, collaboration on biopesticide production with experts from TABRC generated processes and capabilities that would be directly relevant to any future Iraqi BW effort.

- Iraq expanded Al Hakam's water and electricity utilities; a move ISG assesses would have significantly expanded the site's potential to support planned biopesticide and SCP production, and also sought to transfer to Al Hakam any and all usable equipment to support the proposed biopesticide and SCP activity. For example, after UNSCOM's first visit to Al Hakam in September 1991, Al Hakam acquired a 1,500-liter fermentor and a dryer from

Al Muthanna in order to strengthen the cover story. Additionally, Baghdad sought to acquire necessary equipment to pursue BW-related work at Al Hakam. In 1995, for example, Iraq attempted to purchase two turnkey 50 cubic meter fermentor plants from a Russian Company that purportedly had expertise in botulinum toxin production. Iraq negotiated a deal with that Russian Company for equipment and assistance. A team of Iraqi scientists and technicians traveled to Russia. The deal fell through because the company did not receive an export license.

***Collaboration with TABRC brought together groups of experts and organizations whose work had direct bearing on future BW work.***

Jabbar Al Ma'dhihi, Head of TABRC, for example was instrumental in designing the process that resulted in reconfiguring Al Hakam to produce Bt bioinsecticide. Dr. Al Ma'dhihi also developed a novel solution to Iraq's need for BW growth media. Unlike traditional bacterial growth media, Al Ma'dhihi's creation was cheap and of domestic origin—made from waste products from food and agricultural processes. He noted that his media induced near 100% sporulation rates in Bt with little or no additional additives or intensive monitoring of the fermentation process. In ISG's view, this media would probably be a suitable media for anthrax spore production. Rihab, herself, has conceded that this media may support growth and sporulation of anthrax and admitted that the use of this media would make monitoring difficult.

- Separately, Dr. Rihab described the purpose of her group's research into alternative media, which was to circumvent the effects of sanctions imposed on Iraq after the 1990 invasion of Kuwait. Nasir Al Hindawi worked on alternative media for *Brucella*. Mosul University, worked on plants as a source of peptone media for anaerobic organisms. Some of the plant media was purportedly suitable for growing pathogens such as *Clostridium botulinum*. Rihab was angry that Mosul's research might attract UNSCOM attention.

***A strategic objective from the earliest days of the BW program was to produce dry agent.*** Dr. Rihab was aware that liquid agent had a relatively short

shelf life and this was demonstrated to her when in 1991, she found that liquid BW agent recovered from bombs and bulk storage containers "was ruined." She therefore found the work at TABRC on drying Bt by Dr. Al Ma'dhihi of great interest. Al Ma'dhihi was able to dry Bt at bench-scale and was working toward pilot-scale levels. This technology was directly applicable to drying anthrax although safety precautions would have been necessary.

- Dr. Al Ma'dhihi used bentonite provided by Al Hakam. The particle size was of 1 to 10 micrometers and Al Ma'dhihi realized that this was too fine for agricultural work. However, such technology is applicable to BW.

Dr. Rihab was pleased with the biopesticide formulation Al Hakam produced. Al Hakam produced approximately 40 tons of dry formulated product each year from 1992 to 1996. In about 1994, Al Hakam slowed down the production of Al Nasr in order to improve the formulation for the farmers. However, there was disagreement among the developer, producers, and end-users on the utility and use of the Al Hakam's dry Bt product called Al Nasr (or "Victory"). Farmers found it cumbersome to use, having to apply it by hand one plant at a time; spraying the product as a liquid slurry by mixing it with water was not successful. Al Hindawi stated, "The Bt produced there was not very popular with the farmers and was not a profitable endeavor." The former minister of agriculture corroborated this view.

- Dr. Al Ma'dhihi, the developer of this product, explained that it was intended to be used by sprinkling the dry material directly on to plants. He commented that farmers did not like the product because the powder was too fine; it aerosolized into a cloud when applied and did not form an adequate residue on the plants.
- Those who produced Al Nasr, Dr. Rihab and Mr. Thamir 'Abd-al-Rahman thought otherwise on the use and value of the product. They both described mixing the dry powder with water to form a slurry and spraying the product using hand sprayers. They thought the product was well received.

***ISG's assessment is that whatever the intention of Iraq's Bt drying technology it was more applicable***

*to BW than biopesticides.* ISG has learned more about the potential use of Iraq's biopesticide program for prohibited purposes from other sources.

- It was reported, but not confirmed, that researchers from the BW program at Al Hakam used other organisms to model work with anthrax after 1991.
- The former chief anthrax technician stated to ISG that the Al Hakam Bt fermentation line would fully support anthrax production. If virulent anthrax isolates were available, it would take by his estimate, one week to redirect the line to begin production of anthrax. He noted however that attempting to dry anthrax using the Al Hakam equipment was highly hazardous without respiratory protection or containment around the spray dryer.

*In early 1995, UN inspectors confronted Iraq with evidence of imports of bacterial growth media in quantities that had no civilian utility within Iraq's limited biotechnology industry, a step that ultimately led to the unraveling of Iraq's cover story regarding continuing BW-related activity.* On 1 July 1995, Iraq acknowledged that it used this growth media to produce two BW agents in bulk, botulinum toxin, and *Bacillus anthracis* spores, between 1988 and 1991. This precipitated Iraq into preparing a *Full Final and Complete Disclosure* (FFCD). Iraq presented the draft version in July 1995. *A final version followed on 4 August 1995, only to be declared void less than two weeks later after Husayn Kamil fled to Jordan.*

Most of what ISG knows about Iraq's BW endeavors dates from the period August 1995 to early 1996. After his departure officials denounced "the traitor" Husayn Kamil and blamed him for Iraq's failure to disclose the BW program earlier. Tariq 'Aziz claims he persuaded Saddam Husayn to make a full disclosure of Iraq's BW efforts to the UN. For a short while information flowed freely and Iraq released a considerable quantity of documents on its WMD programs in anticipation that this would lead to the lifting of sanctions. (However, in the biological field there were only around 200 items, including notebooks, papers, receipts, photographs, videotapes and journal reprints. For a program that had already lasted more than 20 years this was a modest collection.) As a consequence of the disclosures, the UN supervised the destruction of Al Hakam and disablement of FMDV in June 1996.

*Iraq's disclosures on its covert BW program almost certainly were tied to the disintegration of the economy, which had hit rock-bottom by late 1995 as a result of UN-mandated economic sanctions.* ISG judges that Saddam was willing to risk an element of Iraq's WMD program in a bid to gain economic and sanctions relief. Getting out from under sanctions, by this time, was an overarching Regime objective. BW research at the time offered no real capability but nevertheless posed the risk of a potential embarrassment that could only get in the way of sanctions relief.

- After a series of drafts, Iraq submitted a new "Full, Final and Complete Declaration" (FFCD) on 22 June 1996. This initiated a series of UN inspections to verify the details and resulted in another FFCD, submitted in September 1996, and a further FFCD in September 1997. Despite these revisions, the new FFCDs did not supply any substantially new information and therefore did not meet UN requirements. The UN was unable to verify the contents of the documents in spite of two Technical Evaluation Meetings between Iraq and the UN in March and April 1998, and July 1998.

### Recovery and Transition 1996-2003

*With the bulk of Iraq's BW program in ruins, Iraq after 1996 continued small-scale BW-related efforts with the only remaining asset at Baghdad's disposal—the know-how of the small band of BW scientists and technicians who carried out further work under the auspices of the Iraqi Intelligence Service.* By 1996, the combination of the destruction wrought during Desert Storm and the deliberate destruction of key BW facilities and equipment under UNSCOM supervision left Iraq with few physical remnants of its BW program. Numerous other dual-use biological facilities were subject to routine UN monitoring.

- Many of the key scientists went to work for the NMD. Others pursued advanced degrees in Iraq's universities or went into the private sector; or work at other government agencies, e.g., TABRC; while at least some continued to conduct small-scale biological research and development in disperse locations under the control of the IIS.

- ISG is uncertain what the function of the multiple IIS laboratories was, and who the scientists were (see also CW section, Annex I). Some of the work conducted there was probably a continuation of the work at the Al Salman laboratories after their destruction in the Gulf war in 1991 and that would include forensic related work. Other objectives were probably to develop poisons for assassination or debilitation. Whether any of the research was directly related to military development of BW agents is uncertain; the nature of some of the reported work would have had direct application to dissemination of ricin.
- Information collected at the time of OIF led to the discovery of assorted laboratory equipment purportedly used by a suspect BW scientist at a Mosque in Baghdad.
- A clandestine laboratory was identified by an ISG team at the Baghdad Central Public Health Laboratory in the summer of 2003. According to an employee of the laboratory, the IIS operated a laboratory at that location for several years. In advance of a 1998 UNSCOM inspection, secret documents were removed and stored at the Director's house. In December of 2002, the laboratory was emptied of all equipment and documents.

***Dr. Rihab hypothesized to ISG that if a BW program had existed in Iraq prior to OIF, it would probably have been conducted in secret within the intelligence community.*** However, ISG's inspection of assorted equipment and sites has not uncovered evidence of either the true nature of IIS laboratories or conclusive links between these laboratories and Iraq's BW effort. ISG notes, in any case, that the tactic of using IIS and covert laboratories has historical precedence dating back to the program's origins in the 1970s, when the IIS provided the BW program with security and participated in BW-related research. Reverting to this practice would minimize the evidence available to inspectors. It would also leave the known and acknowledged BW workers free to deal with the UN inspection regime. However, it would require another cadre of scientists other than ones known to the UN to conduct this kind of research. The discovery of multiple IIS clandestine laboratories after OIF lends some credence to this assessment.

- There is information that suggests that up to 5 IIS laboratories operated in the greater Baghdad area at various times up until OIF.
- ISG found a possible DGS laboratory in Baghdad that contained a variety of chemicals but no laboratory equipment. Residents in the building alleged that the laboratory was a biological one. The investigating team found several DGS administrative documents, some of which were from employees requesting approval for danger pay for their hazardous work with biological and radioactive materials.
- A former IIS chemist indicates this five-story building and adjacent warehouse complex comprises the M16 training center at Djerf-al-Nadaf, SE of Baghdad. A former member of the NMD reported this site as one of the three IIS locations with equipment and activities intentionally not declared to the UN. Neither UNSCOM nor UNMOVIC were aware of their existence and had not visited these facilities. He believes the building contained a biological laboratory for unspecified work. Site exploitation revealed a modern building that probably housed both offices and at least one laboratory on the first floor. The building was completely looted, with very few remnants of equipment, materials, or documents. Neighbors indicated that the IIS removed everything from the site just before the war.
- According to a former mid-level BW scientist, Iraq conducted tests on prisoners using aflatoxin in 1994 at an undeclared clandestine facility. A former member of the NMD indicated he visited the facility in 1997 or 1998 to survey the equipment for possible declaration to the UN; he was told on-site that none of the equipment or activities there would be declared.
- ISG also has evidence that, possibly as recently as 1994, an IIS chemist who immigrated to Iraq from Egypt, Dr. Muhammad 'Abd-al-Mun'im Al Azmirli (now deceased), experimented on prisoners with ricin resulting in their deaths.

- In the chemical field, ISG learned that, in the 1970s, the former IIS Directorate of Science and Technology, M9 (which later transformed into M16) used this approach for research into lethal agents. The IIS used a succession of four clandestine laboratories in At Taji and Baghdad between 1996 and 2003 to research and develop chemicals. It also included testing of chemicals on small animals like mice, rabbits and rats.
- Additional reporting, though unconfirmed, indicates that M16 also conducted BW related research at two covert laboratories. In the early 1990s, Saddam tasked the IIS to do small-scale BW work in covert laboratories concealed within legitimate facilities. Further unconfirmed reports indicated the IIS conducted BW and CW experiments and stored WMD precursor materials in residences and warehouses around Baghdad until at least April 2003.

## Research and Development

***ISG judges that Iraq maintained the expertise and equipment necessary for R&D of bacteria, fungi, viruses, and toxins that could be used as BW agents up until Operation Iraqi Freedom (OIF) in March 2003***

- ISG assesses that Iraq's bacterial and toxin BW agents were adequately researched and developed at the advent of the first Gulf war in 1991, and that Iraq had an extensive BW R&D program in the years prior to that. By the time of Desert Storm, Iraq had weaponized *Clostridium botulinum* ('Agent A'), *Bacillus anthracis* ('Agent B') and Aflatoxin ('Agent C') by filling liquid forms of these agents into munitions, although these munitions were not the most effective or efficient for BW dispersal.

***Despite evidence of Iraq's intent to develop more dangerous biological agents after Desert Storm, ISG uncovered no indications that biological agents were researched for BW purposes post-1991, even though Iraq maintained—and in some cases improved—research capabilities that could have easily been applied to BW agents.*** ISG's investigations found no direct evidence that the expertise or equipment were being used specifically for BW work. That said, ISG judges that further R&D on the agents weaponized pre-1991 was probably not required. Additional agents would have required extensive R&D, in ISG's judgement, but despite concerns that surrounded the possible addition of other, more pathogenic, agents into the viral BW program, no evidence has been found by ISG.

- ISG conducted site visits and multiple interviews investigating Iraq's possible possession of smallpox and collected fragmentary and circumstantial information. A definitive conclusion is impossible, but, based on the available evidence, ISG concludes that Iraq intended to develop smallpox and possibly other viral pathogens like CCHF as potential BW weapons. In December 1990, Dr. Rihab informed Dr. Hazim 'Ali that Husayn Kamil wanted him to work on "more dangerous" viruses. According to a source, Dr. Hazim 'Ali was willing to work on other viral agents if Dr. Rihab provided him with

the materials. No additional materials were provided. Iraq had the basic capability to work with variola major (smallpox) and may have conducted some preliminary basic research. However, ISG has found no conclusive evidence that Iraq retained or acquired any stocks of smallpox or conducted advance R&D of pathogenic viruses.

ISG uncovered troubling information about post-1991 BW-related endeavours that raise concerns about the legitimacy of Iraq's activities and that suggest to ISG Baghdad aimed at some future time to resume its BW program.

- In the 1990s Iraq decided indigenously to research and produce nutrient growth media that could be used to produce multiple strains of bacteria to include *B. anthracis*, but no direct evidence has yet been uncovered that this media was used to produce *B. anthracis* post-1991. Dr. Rihab described to ISG her BW group's research in developing indigenously produced media to circumvent the effects sanctions imposed on Iraq after the 1990 invasion. Research into alternative media for the growth of *Brucella* was conducted following the introduction of the 1990 UN sanctions.
- Multiple sources have told ISG that the *B. thuringiensis* research and production at Al Hakam from 1991 to 1996 was done to provide cover for the equipment and capability at this facility. ISG has not been provided with a good explanation as to why an advanced capability to dry agent in a particle size too small for efficient biopesticide use was established as well. ISG judges that this work advanced Iraq's expertise and knowledge in large-scale drying of *B. anthracis* even if the agent itself was not produced and dried.
- ISG has found that up to five IIS laboratories operated in the greater Baghdad area up until OIF. Additional reporting, though unconfirmed, indicates that the M16 Division also conducted BW related research in two covert laboratories. In the early 1990s, Saddam tasked the IIS to do small-scale BW work in covert laboratories concealed within legitimate facilities. Further unconfirmed reports indicated the IIS conducted BW and CW



experiments and stored WMD precursor materials in residences and warehouse around Baghdad through April 2003. Information collected at the time of OIF led to the discovery of assorted laboratory equipment purportedly used by a suspect BW scientist on the Black List at a Mosque in Baghdad. A clandestine laboratory was identified by an ISG team at the Baghdad Central Public Health laboratory in the summer of 2003. According to an employee of the laboratory, the IIS operated a laboratory at that location for several years. In advance of a 1998 UNSCOM inspection, secret documents were removed and stored at the Director's house. In December 2002, the laboratory was emptied of all equipment and documents.

### Building Human Capital

*Over the course of many years Iraq undertook concerted efforts to create the cornerstone of a national BW program: a body of trained scientists with the professional skill and experience needed to develop and produce BW.* Unlike nuclear and chemical weapons programs, which require vast physical infrastructure, expensive equipment and substantial financial resources, human capital is the essential element of a national BW effort, for scientific research underpins all aspects of a developing BW program. Iraq made the most of a limited pool of qualified personnel to identify and develop the requisite cadre of skilled scientists and technical personnel.

- Trying to develop such a cadre for the BW as well as CW programs was an integral part of the overall Al Hasan Ibn-al-Haytham Institute's goals. UN inspectors discovered that during the 1970s the Al Hasan Ibn-al-Haytham Institute recruited the best and the brightest graduating students—from the Universities of Baghdad, Colleges of Medicine, Science, and Veterinary Medicine, and the University of Mustansiriyah, College of Medicine. The Institute offered these students employment with incentives including opportunities for travel abroad and further education. Students selected for biology then attended a two-month training program at the University of Baghdad, College of Veterinary Medi-

cine, in "laboratory techniques and procedures." Some were selected for graduate studies abroad and some for graduate studies at the University of Baghdad or the University of Mustansiriyah, while others were given technician positions at the Ibn-Sina Center.

*ISG assesses that at some point after the revitalization of Iraq's BW program in the mid-1980s, a shift in priorities occurred in which Iraqi BW personnel were selected for participation in the program more for their loyalty and dependability than for their technical skills, an approach that distorted the entire higher educational process and frequently ensured that the "best and the brightest" were replaced by the loyal and reliable.*

- A senior Iraqi scientist described to ISG a practice that began in the early 1990s and continued until 2002 as a possible Husayn Kamil initiative. This initiative reportedly named *Al Mumtazin*, or "the distinguished," involved nominating candidates for post-graduate education based on their loyalty to the Regime, institution or superior rather than their technical competence. These "distinguished" candidates reportedly had lesser grades and were generally older than published requirements, according to an ISG interview with a senior Iraqi scientist.
- In a possible bid to counter the corrosive effect of selecting personnel for political and professional reasons, in the mid 1980s, Iraq established a mentoring process through which to conduct investigations into possible BW related bacteria and toxins. This system, used throughout the BW program, utilized compartmented small clusters headed by a senior scientist who had extensive research experience or a senior technician with extensive experience with either the agent or a class of bacteria of interest according to multiple sources who participated in the former program.

## Research Facilities

Iraq's R&D to develop BW started in 1974 at the Al Hasan Ibn-al-Haytham Institute. Initially the BW effort was located in a house in the Al 'Amiriyah suburb of Baghdad, and then moved to Al Hasan site number 2, also known as the Ibn-Sina Center, at Al Salman. The biological part of the Al Hasan program was "research on microorganism for military purposes." It included antibiotic and environmental resistance, means of production, and agent preservation. Agents included *Staphylococcus aureus*, Bacillus species, *Vibrio cholerae*, botulinum toxin, influenza and polio viruses, and others. Although the militarily relevant piece of the Al Hasan biological program seems to have entered a hiatus with the closure of the Institute, biological activities, not specifically directed toward BW weapons continued unabated at the Al Salman site.

In the formative phases of the BW program, the Ibn-Sina Center was the primary center for BW R&D. Some BW R&D continued unabated at Ibn-Sina Center, which began to broaden in 1984. When Iraq revitalized the militarily relevant BW program in the mid-1980s, Al Muthanna was the primary site until 1987 when the program again moved to the Ibn-Sina Center. However, Al Muthanna continued with specific R&D participation such as that with ricin and aflatoxin on behalf of Al Salman. R&D continued at the Ibn-Sina Center until mid to late 1990 even after much of the BW program moved to the newly established Al Hakam facility in 1988.

In 1990, with the compulsory acquisition of the Al Dawrah FMDV Plant and the Agriculture Water Resource Center (AWRC) facility and R&D and production of aflatoxin moved to the AWRC. In addition, BW-applicable R&D was conducted during the 1980s at TABRC. Al Hakam continued to be a key BW-related R&D facility until 1996, when it was destroyed under UNSCOM supervision. Additionally, Al Hamath, TABRC, and the Tariq Facility (Fallujah III) were also key sites during this period (for more complete information on Iraq's R&D facilities and ISG's exploitations, see Annex B on BW Research and Development).

## Iraqi BW Agent Research

*Iraq's efforts to develop BW agents were extensive, and in the years leading up to the first Gulf war Baghdad investigated a wide range of biological agents with potential military applications.* ISG investigated the extent of Iraq's research prior to the war, and assessed the degree to which Baghdad pursued development of these agents in the aftermath of Desert Storm.

### ***Bacillus anthracis* ('Agent B')**

*Baghdad invested considerable time and effort prior to 1991 in the development of anthrax as a biological weapon. ISG assesses that the effort ended with Desert Storm. However, studies of simulants aided the quality of any future anthrax products.*

R&D on growing the anthrax organism and inducing sporulation was initiated at Al Hasan site number 2, but the work was terminated at the end of 1978. The R&D was reinitiated in 1985 at Al Muthanna. Although denied by Dr. Rihab, the studies may have picked up where the Al Hasan studies left off, and work progressed rapidly and included laboratory production, characterization and storage.

- After the transfer of the BW effort from Al Muthanna to Al Salman, scale up production and aerosol studies (dry and liquid) were conducted. A continued interest in obtaining a suitable dry product and the efforts expended to acquire a suitable drying capability continued at Al Salman and later at Al Hakam.
- Iraq obtained two capable dryers that were air-freighted into Baghdad in 1989. One of these dryers was located at Al Hakam in 1991. Iraq also tried to obtain an "aseptic" spray dryer (identical to those air-freighted to Baghdad, but with additional biological containment capabilities) in 1990. This dryer was not delivered by the supplier.
- Static tests (using simulants for *B anthracis* spores) were conducted in March 1988 in LD250 aerial bombs. Dynamic and static trials using 122 mm rocket warheads filled with simulant were conducted in 1989 and 1990. Trials were then conducted in August 1990 using R-400 aerial bombs, again filled with anthrax simulant.

***ISG continued to gain more insight into B. anthracis work done before 1991, which reinforced the findings of UNSCOM detailed below. However, no new information has been obtained on B. anthracis-specific R&D conducted after the 1996 destruction of Al Hakam.***

- Thamer ‘Abd-al-Rahman, a key figure in Iraq’s anthrax work pre-1991, told ISG that he attempted to obtain the Ames strain of *B. anthracis* which he considered “very virulent” while attending a scientific workshop in 1989, but he was unsuccessful in that endeavor. Iraq declared researching different strains of *B. anthracis*, but settled on the American Type Culture Collection (ATCC) strain 14578 as the exclusive strain for use as a BW.
- Prior to work on the pathogenic strains of *B. anthracis*, Dr. Rihab directed the scientists to use surrogates in their early and more advanced stages of R&D and production. Accordingly, experiments were done with surrogates, *B. thuringiensis*, *Bacillus subtilis* and *Bacillus megaterium*, in order to determine appropriate growth conditions. Her logic was in part for safety. She wanted to permit the researcher to familiarize and learn procedures with a nonpathogenic organism before attempting to use pathogenic ones. These bacillus strains were used to simulate work on *B. anthracis* by researchers at Al Hakam after 1991. A similar practice apparently was followed 1985-1990. Laboratory-scale work was done with the *B. thuringiensis Israeliensis* strain at Al Hakam to determine optimized growth conditions. The main work, and ultimate production, of *B. thuringiensis* was conducted utilizing the *Kurstakii* strain. *B. megaterium* was researched at Al Salman in 1987-1988 as a model for *B. anthracis* using a 150l fermentor.
- One large field experiment was also planned and, according to the source, the experiment involved spreading of the bacteria by an airplane. ISG found no further information on this experiment. The information provided by the source confirms existing knowledge about Iraq’s use of *B. thuringiensis*, *B. subtilis* and *B. megaterium* as simulants for *B. anthracis*. However, as this is information that comes from a single source, ISG is unable to con-

firm the veracity of the claim of continued research into *B. anthracis* at Al Hakam following the 1991 Gulf war.

- ISG found information that indicated that research into anthrax vaccines was conducted at the Abu Ghurayb Veterinary College (Baghdad University, College of Veterinary Medicine). Unfortunately, ISG was not able to obtain further information as to what this research involved or what vaccine strain was utilized.

### **Clostridium botulinum (Botulinum toxin, ‘Agent A’)**

ISG has uncovered no further information to suggest that Iraq actively continued to research and produce *C. botulinum* for use as a BW weapon following the 1991 Gulf war.

R&D on botulinum toxin was an integral part of the Al Hasan site number 2. Efforts appeared to be modest but were focused on growth conditions for maximizing toxin yield. This effort was terminated at the end of 1978 when Al Hasan was dissolved.

Tests then were re-established when the militarily relevant BW program was revitalized in 1985 at Al Muthanna. Seemingly, building on the knowledge gained by the Al Hasan effort, rapid progress was made. By early 1987, before the program was moved to Al Salman, inhalation studies on botulinum toxin were conducted in the 5m<sup>3</sup> inhalation chamber at Al Muthanna.

At Al Salman, studies progressed to where field trials on the dispersal of liquid botulinum toxin using LD-250 aerial bombs were conducted in March 1988. After the move to Al Hakam in 1988, with its larger agent production capability, static (November 1989) and dynamic (May 1990) trials were conducted using 122 mm rocket warheads at the Al Muhammadiyat test range. R-400 aerial bombs were also tested in August 1990 as were the effects of metals (simulating the interior of munitions) on the agent.

### **Clostridium perfringens ('Agent G')**

*No information was discovered to suggest that BW-related research into C. perfringens continued after the 1991 Gulf war.* Following the end of OIF, ISG obtained information relating to *C. perfringens* that essentially confirmed previous UNSCOM findings regarding Iraq's work on this bacterium as a BW agent.

- In late April 1988, Dr. Rihab initiated research on *C. perfringens*, known as 'Agent G', to facilitate its use as a BW agent. The development of 'Agent G' occurred at the Technical Research Center (TRC), Al Salman, and was directed by 'Ali Shihab during the late 1980s. Dr. Rihab instructed the researchers to investigate the various strains and identify the most effective for use as a large-scale BW agent. According to a source, the intent of the research was to disseminate *C. perfringens* as spores.
- The initial stage of the *C. perfringens* project focused on identifying a medium in which to optimize growth. Researchers procured Duncan and Strong growth media and modified the salt and nutrient levels. This initial research on media and isolates occurred in the beginning of 1990. The second phase of the research focused on bench scale production of 'Agent G spores', with the first successful production of *C. perfringens* spores in March 1990.
- As part of the second phase of research, the research protocol called for animal testing to be conducted quarterly and the results forwarded via an official report to Dr. Rihab. ISG has two accounts for the testing that occurred. One source describes research conducted in a small aerosol chamber on rabbits and mice attempting to inoculate abraded skin in these experimental animals. The results obtained through these experiments left the test animals with lesions typical of *C. perfringens* infection. The second account also involves the use of an inhalation chamber to aerosolize spores and infect the laboratory animals but after autopsies were performed, researchers concluded that aerosolized spores may not be effective as a BW agent. They then began injecting 'Agent G' via syringe and this resulted in successful tests using

guinea pigs and mice. The animals developed Gas Gangrene infections at the wound sites and eventually died. Results from the successful tests were reported to Dr. Rihab in April 1990, who instructed the researchers to move the production of 'Agent G' to a larger scale.

### **Aflatoxin ('Agent C')**

R&D on aflatoxin began in May 1988 based on previous nonmilitary work on aflatoxin by Dr. Imad. Good progress was made which led to an initial weapons test in November 1989, consisting of static trials with 122 mm rocket warheads. Additional testing involved combining aflatoxin with CS and CN incapacitating agents as well as mustard CW agent. Studies included potency retention under conditions and temperature of deployment as well as effect of metals on the agent. This was followed by dynamic testing trials in May 1990. However, R-400 aerial bombs and Al Husayn missile warheads were munitions selected for BW weaponization in late 1990.

In 1992, an individual at the Central Public Health Laboratory—who worked for the SSO and was responsible for checking Saddam's food for contamination—denied having an aflatoxin standard, according to a source with direct access but of unknown reliability. According to the same source, the former director of CPHL had been involved in offensive aflatoxin research until at least 1991.

Debriefings since April 2003 of sources formerly involved with BW efforts indicate that Iraq at least continued research on aflatoxin throughout the 1990s. In 1994, a DGS forensics laboratory produced 150 ml of aflatoxin for testing on humans, according to a mid-level scientist who formerly worked in the BW program and visited the site.

### **Brucella**

*Dr. Rihab supported inclusion of brucella in Iraq's BW program and actively supported pre-Desert Storm research to that end. That initiative, however, appears to have ended in the wake of the first Gulf war.*

According to a source, Dr. Rihab wanted to add *Brucella* to the list of BW agents. According to a former

mid-level scientist who worked at several Iraqi BW program locations, he conducted research on *Brucella* at Al Hakam prior to Desert Storm and later at Baghdad University until 1992 using imported strains and patient isolates, respectively, according to the scientist. The research included isolating bacterium, growing it in culture, extracting and purifying its toxins, and testing the toxin on mice. Although this research was not declared to UNSCOM, the scientist stated that his thesis was open.

- Rihab and Ahmad Murtada, the Director General of the former TRC, recommended that the scientist conduct the research as part of graduate degree on *Brucella* at Baghdad University under the direction of Alice Krikor Agap Melkonian. Before the war, the researcher conducted laboratory work at Al Hakam and course work at the university. Rihab provided the *Brucella abortus* isolate the researcher used at Hakam but it was not from the *B. abortus* isolates obtained by Rihab from American Type Culture Collection: none of these had been opened. The scientist stopped research on *Brucella* during the war but resumed his work after that at the university, working on isolates from a hospital patient. According to the mid-level scientist, the *Brucella* work was not secret and his thesis about the work was not classified.
- In 1991, after the war, work on *Brucella* restarted at the College of Science with an isolate from a patient at the Ibn-al-Khatib Hospital and was coordinated through the Ministry of Health. During the project, *Brucella* was isolated and grown. The researcher extracted and purified the endotoxin, tested it on mice and determined the toxin was not as effective as Shiga toxin, ricin or botulinum. Rihab received a copy of the researcher's report and work on *Brucella* was supposed to start on the person's return to Al Hakam but it was put on hold by Dr. Rihab in 1992 to focus on research and production of *B. thuringiensis*.
- Research on *Brucella* was also conducted at the Abu Ghurayb Veterinary College, but ISG has no information on the extent of this work.

- Research into alternative media for the growth of *Brucella* was conducted following the introduction of the 1990 UN sanctions. This research was carried out by 'Ali Shihab. ISG found no information to indicate the timescale of research, the results or whether the research was successful.
- After the establishment of the Al Razi Center in 1992, the Microbiology department, directed by Dr. Antoine Al Bana, carried out research into diagnostic kits for *Brucella*. The facility was visited by the ISG BW team who discovered *Brucella* bacterial isolates obtained from Al 'Amiriyah Serum and Vaccine Institute (ASVI) (see Figure 3). The strains found were *B. abortus* and *B. melitensis*. Although, pre-OIF, the facility had maintained the capability to conduct successful BW-related R&D on *Brucella*, there were no indications that this had occurred.

### Ricin

***The evidence surrounding Iraq's investigation of ricin for BW purposes is unclear, and thus ISG can offer no definitive conclusion. It is clear that Baghdad had weaponized ricin in at least a limited fashion prior to the first Gulf war. There is at least some evidence of post-war IIS involvement in ricin research and possible human testing, but ISG developed no definitive information with which to confirm reports of post-war production.***

Iraq's R&D on ricin had its origin in the mid 1980s at the Scientific Research Center (SRC). In 1988/89 active collaboration was sought from personnel at Al Salman. The research proceeded apace with initial field trials using 155 mm shells in Nov 1990. The work at the SRC was initiated at the behest of an official with the Internal Security Service who followed the efforts through the field trial (see Figure 4).

ISG conducted a focused investigation into Iraqi work with ricin—a toxin derived from castor beans (*Ricinus communis*) of the indigenous Iraqi *R. communis* plants. The search to date has yielded conflicting information about the use of castor beans and continued ricin work after 1998.

ISG is aware from UNSCOM reporting that Iraq conducted limited weaponization of ricin prior to Desert Storm and that it conducted partially successful field trials with ricin. Based on this, ISG focused on two main themes: (1) part of the Al Tariq Facility—also known as Fallujah II—for castor oil production, and (2) the reported IIS work with the toxin. While ISG has not been able to find direct evidence of recent ricin production, several sources have provided information that suggest that work on ricin toxin continued well past 1992, possibly until the beginning of OIF.

The ISG team examined in detail the Al Tariq Facility and a site that supplied Al Tariq with castor beans—the Al ‘Aziziyah farms. The team debriefed a number of scientists and engineers employed at Al Tariq and a group of farmers from Al ‘Aziziyah, obtaining from each group a very different picture about work at Al Tariq and the intended use of the castor beans. Al Tariq staff employees maintained that castor beans were used exclusively for the processing of castor oil for the brake fluid and tire production industries. They also admitted contemplating the use of castor oil as an anti-foaming agent in the yeast industry. When prompted with a few more specifics, one Al Tariq employee explained away the activity as being pharmaceutical-related. Another shipment of castor beans, for a university, remains to be explained. For more information on this facility, see Annex 2.

***ISG has investigated claims by former IIS officials—a former IIS chemist and his former supervisor, the late Dr. Al Azmirli—that the IIS produced ricin until at least 1995 and possibly until 2003, although ISG has not yet obtained direct evidence of ricin work.***

- Interviews with Dr. Al Azmirli—a former IIS official and scientific advisor to Saddam—revealed that the IIS researched ricin as a BW agent until 2003. He himself was directly involved with ricin work until 1992, when Husayn Kamil demanded the program be turned over to Dr. Rihab and a doctor from the Ministry of Agriculture.
- Dr. Al Azmirli claimed that between 1992 and 1996, ricin was being produced at Al Shameir Hospital in Al Rashad until it was transferred to Al Hakam. A separate former IIS official confirmed that Al Azmirli produced approximately two kilo-

grams of ricin at the Ar Rashidiyah plant in 1991 and 1992. An exploitation of the Ar Rashidiyah plant corroborated the location and presence of a facility, but ISG could not confirm that ricin work had occurred there because of extensive looting.

- Mun’im Mustafa Fatahi, a close friend of Dr. Al Azmirli, reportedly told Al Azmirli that a group of people was actively pursuing ricin for weaponization. As of March 2003, ricin was being developed into stable liquid to deliver as an aerosol in small rockets, cluster bombs, and smoke generators, according to Al Azmirli.
- Documents obtained from Dr. Al Azmirli’s residence included an MSc thesis on the topic of ricin written by ‘Adnan Jasim from Baghdad University.

**ISG has investigated claims from several sources that work on ricin toxin continued well past 1992, possibly until the beginning of OIF.** The information that ISG obtained on the potential role of ricin in Iraq’s BW program post 1991 has primarily been based on single source reporting of unclear veracity.

- The IIS was involved in the research and limited production of ricin for the development of a BW weapon. A source stated that ‘Adnan Abd-al-Rasa’il Al ‘Ubaydi was responsible for all research related to ricin conducted by the IIS. In 1992, ‘Adnan produced a few milligrams of ricin. The IIS was then ordered not to continue with the ricin project because Husayn Kamil wanted the project. The source stated that all research and production processes were turned over to Dr. Rihab and a doctor from the Ministry of Agriculture. A group in Al Hakam was then involved in ricin production after 1992.
- According to a single source, the MIC maintained fields of castor plants in the Al ‘Aziziyah area for sale to the Al Tariq Company. According to a source, the castor beans harvested from these crops were allegedly used to make brake fluid and “chemical weapons.” When asked if the “chemical weapons” were possibly insecticides or pesticides, the source stated that the “chemical weapons” were used against humans. As the product of a single source, this information is hard to verify.

- During the approximate period of 1994 or 1995, Husayn Kamil, then Head of MIC, gave an order to confiscate farmland that belonged to the source in the area of Al ‘Aziziyah. By Husayn Kamil’s order, castor plants were to be planted on the acquired land and the MIC remained responsible for delivering the beans for each year’s planting. The source also reported that a castor crop was planted every year within different farming areas in the vicinity of the Al ‘Aziziyah. To hide the fact that MIC possessed dedicated castor fields, a cover story was developed between MIC and the Ministry of Agriculture or Ministry for Industrial Crops. Wheat, corn and cotton were subsequently planted in the vicinity of the castor crops, as a “cover crop.” The Ministry of Agriculture maintained a cover for the MIC in the area of Al ‘Aziziyah with offices for project managers. The same source indicated that the cover story was used to deceive UN inspectors.
- All the castor beans grown at this location were delivered to the Al Tariq facility. According to the source no payment was ever made for the castor beans. The only payment that occurred for the overall transaction was to the farmers who worked in the fields. There were various project managers who handled paying the farmers, who were on the payroll of the Tariq facility and ultimately MIC. The castor crops were planted in approximately February and March, and harvested annually in September. Each harvest yielded approximately 250 to 300kg of castor beans. The Al Tariq facility would normally send four or five trucks to the Al ‘Aziziyah warehouse to take delivery of the castor beans.
- During an exploitation of the TABRC facility, the team discovered a piece of equipment they determined was associated with de-hulling of castor beans (see Figure 5). The exploitation team also discovered a 100-ton press containing an oily residue and took a sample of this material. This material returned a positive test for ricin. Although a positive result was obtained this discovery does not indicate on its own any illicit activity on behalf of the facility, as any step in the production of castor oil will return a positive test for ricin. The scale of the equipment was small and no reason was provided as to the purpose of the machinery.

ISG investigated a laboratory at the Al ‘Abud Trading Complex, Baghdad. Evidence of ricin was found in samples collected, both by field analysis and at ISG laboratory assays.

- Based on the materials, equipment, and manual found at the site, ISG judged the complex did not appear to be related to the Regime’s chemical, or biological weapons programs. Rather, it appears to be an extremist-run laboratory with equipment and reagents that at a minimum could be used to produce ricin. Biological growth mediums and chemical precursors (triethanolamine) were also found in the laboratory.

#### **Wheat Cover Smut (‘Agent D’)**

R&D on wheat cover smut (bunt of wheat) was initiated in 1984 at the Al Salman site. After the BW militarily relevant program was moved from Al Muthanna to Al Salman, the wheat cover smut project was merged into a fungi and fungal toxin group within Dr. Rihab’s group. Smut spores were tested in static field trials in late 1989. Tests to evaluate smut spores as a carrier for aflatoxin were also part of the program. No additional information has been found by ISG related to Iraq’s interest in and work on smut spores.

#### **Viruses**

*Prior to the first Gulf war Iraq pursued a range of viral agents as part of its BW program. ISG has uncovered no direct evidence to indicate a renewed interest or organized program to re-establish an Iraqi viral BW program and judges that Baghdad’s viral BW effort ended in 1991.*

Researchers involved in Iraq’s 1970s BW research at the Al Hasan Institute reportedly attempted to develop influenza virus as a BW agent and were also conducting R&D on polioviruses. There were two virologists in the original group; one was a US trained veterinarian Dr. Muzhir Al Falluji, who had training and experience in animal orthopox (smallpox like) viruses; the other was Dr. Muslih Al Muslih (the 3<sup>rd</sup> Director of Ibn-Sina Center) who worked on poliovirus. Dr. Al Falluji taught several classes at the College of Veterinary Medicine. The Al Hasan Institute was closed in 1979 and along with it, the viral programs.



**Figure 3.** Entrance to al-Razi facility.



**Figure 4.** Castor Beans, found at the al-Abud laboratory by the ISG.



**Figure 5.** Thresher used to mash castor beans found at TABRC.



Iraq's viral BW program began its research and development (R&D) phases in July 1990 under the direction of Dr. Hazim 'Ali. This was the second known attempt by Iraq to conduct BW viral research. From 1973 until 1978, The Ibn-Sina Center of the Al Hasan Ibn-al-Haytham Research Foundation conducted research at its Al Salman site.

Iraq subsequently revived its BW programme in the mid 1980s. The revival of the Iraqi viral BW program began in early to mid 1990 when Dr. Hazim 'Ali was chosen to lead the effort. Iraq's pursuit of viral BW began over 4 years after the initiation of its research for bacterial and fungal agent development.

According to Hazim 'Ali, the viral BW program ended on 17 January 1991. This information is consistent with an English-language document titled "Viral Agents Program" obtained through the investigations of ISG, which states that work on the viral program began on 1 December 1990 and was cancelled on 17 January 1991, when all specimens were destroyed. This is in contrast to information provided to UNSCOM that included laboratory notebooks and ISG information stating that Dr. Hazim 'Ali isolated and began growing camelpox in October 1990.

Because of pre-OIF intelligence assessments about Iraq's possible possession of smallpox, ISG conducted extensive investigations that included site visits and multiple interviews to determine the validity of this assessment. ISG has collected fragmentary and circumstantial information that provides no definitive conclusions, either way on this issue.

- ISG has collected information from credible sources from the pre-1991 program demonstrating Iraq's interest and intent in developing pathogenic viruses specifically smallpox.
- Further, ISG assesses that Iraq maintained the capability in its personnel and basic equipment to conduct R&D into viral agents including smallpox.
- Finally coinciding with the 1991 Gulf war, Iraq intended to develop a production base to support pathogenic viral production.

### Camel Pox

*Iraq's interest in camel pox and its inclusion in the viral BW program have led ISG to assess that camel pox R&D was a surrogate for smallpox research, analogous to the use of nonpathogenic Bacillus species and Bacillus anthracis.*

According to Hazim 'Ali, researchers in Iraq's BW program followed the practice of working with particularly pathogenic micro-organisms surrogates to facilitate transition to the actual pathogens. This approach permitted the researcher to familiarize and learn techniques, procedures and processes to increase the safety margin for the researcher and technicians.

- In Dr. Rihab's own words, Hazim's decision to work with camel pox was because "it was near to smallpox." When directly questioned about the possibility of smallpox in Iraq, she misspoke on 3 occasions saying "there is no camel pox in Iraq."
- Camel pox was one of the three viruses chosen for the viral BW program by Hazim 'Ali. According to Hazim, no experiments were conducted to determine the effectiveness of camel pox on humans. His decision to develop camel pox was based on his research of citations from standard microbiology and microbial infection textbooks. His recollection was that camel pox causes rare cases of human infection but these were not severe. Dr. Hazim's rationale for the utility of camel pox as a possible BW pathogen remains inconsistent with current and historical published scientific and medical knowledge.

ISG has no information to contradict his statements that his research only succeeded in initial isolation of camel pox from a clinical specimen obtained from the Veterinary Diagnostic Research Center in Abu Ghurayb.

The camel pox sample (scab) was not available immediately but by the end of October 1990, Hazim 'Ali obtained a sample and successfully isolated the virus in chicken eggs. Chicken eggs were inoculated with the camel pox and the results were promising with some characteristic lesions (white pox marks) appearing on the chorioallantoic membrane of the chicken egg. These lesions on the chorioallantoic membrane of a ten-day old chicken embryo were characteristic of infections described in textbooks.

Hazim claims he cannot remember if animal testing occurred. The source stated that a pilot experiment should have been conducted with the isolate to assess for activity in an animal; rabbits are particularly susceptible to camel pox. However, he could not remember an actual test of the viral isolate on rabbits due to the critical time in which the test would have occurred; the 1991 Gulf war. Hazim does not believe that anyone else could have carried out this experiment in his absence or without his knowledge.

Hazim investigated existing facilities in Iraq for scaling-up the production of camel pox if and when that was possible or necessary. He decided on using the chorioallantoic membrane method of viral egg production. Although denying a plan for large-scale production, he inspected the Veterinary Service Center in Irbil. It was used in the production of animal vaccines for Newcastle disease and fowlpox. The Irbil facility had a moderate scale egg production capability but according to Hazim an untrained staff. The large size of the facility required was explained due to the fact that the amount of virus obtained through this method would only average 5 mg of tissue.

This facility was autonomous to the Iraqi Government and an order to commandeer the plant for Hazim's activity was signed by the Minister of Agriculture. However, the order was never implemented.

Dr. Hazim 'Ali's performance in leading and conducting Iraq's fledgling viral BW research, based on comments by his colleagues, was underwhelming. Rihab described him as "not a man to work by himself." Dr. Nasir Al Hindawi commented that Hazim 'Ali did not produce a single virus.

### **Smallpox**

***ISG concludes that Iraq had a pre-1991 intent to develop smallpox as a strategic viral BW agent and had the basic capability to work with variola major (smallpox). However, ISG has collected no direct evidence that Iraq either retained or acquired smallpox virus isolates or proceeded with any follow up smallpox related research. ISG assesses, however, that Iraq did have the capability to conduct research into smallpox, if not in a manner up to Western BL-4 containment standards. Iraq possessed facili-***

***ties such as the Al Dawrah Foot and Mouth Disease Vaccine Plant and Al Razi Center had equipment that could potentially be used to work on high-risk agents such as smallpox.***

Prior to OIF, the US intelligence community assessed that Iraq probably retained samples of the smallpox virus and may have been researching it for BW purposes. It was also stated that it had no information indicating whether such work was ongoing. Despite the limited information gained by the UN and a claim by a senior player in the CBW program that the intent of the viral BW program was to weaponize smallpox, the additional information uncovered by ISG has not provided evidence of an R&D effort to weaponize smallpox.

- According to Dr. Mahmud Farraj Bilal Al Sammarai, a senior official involved in the weaponization and testing of CBW agents, the aim of the viral BW program was intended for the weaponization of smallpox. He states that Dr. Hazim 'Ali started with Camel pox since it was easier to work with for development, but ultimately the program was intended to progress to smallpox. Dr. Bilal did not know for a fact that samples of smallpox existed within Iraq but stated that 'Ali might obtain them from the Baghdad Central Public Health Laboratory or collections at the Al 'Amiriyah Serum and Vaccine Institute (ASVI). Dr. 'Ali Mukhlif, Dr. Hazim 'Ali's sponsor to work with the TRC, told Bilal the intention of the program and Hazim's activities during a meeting at Al Muthanna in 1990.
- During investigations conducted by ISG and earlier by UNSCOM, Dr. Hazim 'Ali occasionally referred to "smallpox" when questioned about their research and quickly retracted the statement to say "camel pox." The source was unable to provide an explanation as to why he repeatedly made this mistake. This type of mistake added to the confusion surrounding Iraq's possible R&D efforts on smallpox. Hazim stated that he would not be surprised if smallpox isolates were found in Iraq and identified two culture repositories where viral cultures could be maintained over extended periods of time: Al Dawrah FMDV Plant and the Baghdad CPHL. None were found by ISG. However, the CPHL seed stock repository was reported to have been systemi-

cally looted post-OIF (see below, under “Feasibility of Maintaining Smallpox Cultures from 1972) and the Al Dawrah FMDV Plant was effectively shut down and electricity turned off after it was rendered unusable in 1996.

Contrary to comments made by Dr. Al Hindawi that there were no virologists in Iraq, ISG identified and interviewed close to a dozen, mostly US and UK trained, highly capable PhD virologists. Several had experience with orthopox (smallpox like) viral research experience mostly with animal related pox viruses. One actually performed genetic engineering research on animal pox viruses attempting to develop a recombinant animal vaccine. A couple had experience working with the smallpox vaccine strain (vaccinia). However, none of Iraq’s “best and brightest” virologists were assessed directly involved in Iraq’s BW efforts. After extensive interviews, none could provide direct information concerning the existence of historical or recent smallpox isolates or research. (See the accompanying textbox on reported Iraqi retention of smallpox isolates.)

---

## *Iraqi Retention of Smallpox Cultures*

***ISG cannot be certain whether or not Iraq had smallpox seed stock to OIF. ISG investigated Iraq's technical and practical capabilities to maintain viral or clinical smallpox isolates from the early 1970s in Iraq. Interviewing a number of senior Iraqi scientists and virologists ISG could make no definitive conclusions.*** ISG notes the stated intent of Husayn Kamil in 1990 to develop more virulent viruses as part of the BW program. While Hazim did not accomplish this objective, ISG cannot rule out the possibility that other, yet unidentified, researchers were given the responsibility to attempt to do so.

In 1978, Ministry of Health (MoH) reported to the World Health Organization that no smallpox cases had occurred in Iraq since an outbreak in 1972, and attested in writing that all remaining smallpox cultures and clinical specimens were destroyed in 1978. There was, however, no independent verification of the destruction of smallpox isolates or clinical specimens that may have been retained by either clinical or research institutes, and subsequent reporting on the subject is contradictory:

- One source ISG interviewed was an advisor to the Iraqi Minister of Health between 1980 and 1982. He stated that he was “90% certain” that Saddam did not destroy the last smallpox samples.
- Contrarily, Rihab stated categorically that no isolates of any kind were inherited by her from the original 1970s BW effort.
- According to a senior Iraq scientist at Al ‘Amiriyah Serum and Vaccine Institute, he was ordered by MoH urgently to produce 3.5 million doses of smallpox vaccine in 1980. This source was the principal responsible scientist involved in this effort. By his accounts, the Iraqi MoH attempted to procure smallpox vaccine seed stocks from the World Health Organization (WHO) in 1980 for this effort. The WHO refused Iraq’s request citing the recent success in the eradication program.
- Intelligence reports dating back to 1994 suggest that Iraq may have obtained smallpox cultures from

*the former Soviet Union (FSU) in 1992. A biologist who had indirect access to this information stated that Iraq acquired isolates of smallpox from Russia in 1992. He went on to describe an effort to develop smallpox for the BW program from 1992 to 1994. He described efforts to grow the virus in both eggs and tissue culture. This effort reportedly failed and the viral cultures were maintained at the CPHL. The subject biologist is no longer in Iraq.*

*ISG has collected no information with which to conclusively refute or confirm the existence of smallpox isolates retained by Iraq from the period when the disease was still endemic, but if they were retained they would have been a potentially serious threat in the context of a renewed BW program.*

- ISG assesses such viral cultures could remain viable for extended periods of time depending on the nature of the isolate, facility conditions and the overseeing scientist. Clinical smallpox specimens would be less likely to survive long-term storage unless they were held in liquid nitrogen. Frozen lyophilized smallpox isolates could, on the other hand, have an extended shelf life and probably remain viable for decades. Several institutes in Iraq had nitrogen freezer storage capabilities.
- ISG did learn that as late as 1992, Iraq was assessing the viability of smallpox vaccine it produced in the 1980s. A scientist who was involved in the production of the smallpox vaccine in the 1980s was asked to test samples presumably from that stockpile. The vaccine was found nonviable. At that time, he recommended that all remaining vials of that vaccine be destroyed. He does not know if that recommendation was followed. Separately, ISG learned from Dr. Hazim ‘Ali that a researcher at the Baghdad University Medical College was actually producing smallpox vaccine in 1996, for whom and for what purpose are unknown.

*Baghdad College of Science was identified as one possible location for smallpox work prior to OIF. An ISG subject matter expert team visited the University of Baghdad, College of Sciences on three separate*

---

### *Iraqi Retention of Smallpox Cultures (continued)*

occasions and toured the facilities in late May and early June 2003. The visit observed generally old, poor condition, and sparse laboratory equipment. The team inspected a room (room 179) marked “Graduate Studies” which had locks on both doors. The room contained a large autoclave. The room had two large overhead fume hoods of the type used in restaurants to filter the air within the room. There was one small plastic class I safety cabinet, several shaker incubators, a glove box, old bottles of culture media. No freezers or liquid nitrogen containers were identified. During the course of its investigations, ISG inspected the Al Kindi veterinary vaccine facility. This facility was similar in function to the one Hazim ‘Ali investigated in Irbil in autumn 1990 that produced Newcastle and animal pox vaccines.

- ISG inspected the production buildings and observed that the equipment appeared to be for the expressed purpose of producing Newcastle virus vaccine in chicken eggs; however, this dual-use equipment was assessed to be easily diverted to produce Variola (smallpox) or other pathogenic viruses (see Figure 6).



**Figure 6.** 1,480-liter double-jacketed steel vessel (left) and egg incubator (right).

- ISG also visited the building where animal pox vaccines are produced in tissue culture. Their assessment was that as with the Newcastle vaccine unit, the equipment in this building could also be used to produce large amounts of smallpox virus in tissue culture although all equipment present is consistent with the expressed purpose of making animal vaccines.

ISG learned of a television news report that was broadcasted on Western television in mid-April 2003 that reported the CPHL had been looted of highly infectious virus such as smallpox, polio and influenza. ISG visited the latter and interviewed senior researchers who described the incident. Several visits to the CPHL and interviews with scientists and researchers have not shed further light into the existence of smallpox cultures being stored there. ISG did identify a “secret lab” that was operated there, which had been vacated in December 2002. The nature of the research in that laboratory was not determined.



### **Crimean Congo Hemorrhagic Fever**

*While Iraqi explanations for why CCHF was not considered for the BW program remains unsatisfactory, there is little substantial information to contradict the explanation.*

Hazim ‘Ali argued against CCHF being considered endemic to Iraq but did not deny that a sample could be obtained during the cyclical infection season. According to Antoine Sabri Al Bana, Iraq’s leading CCHF expert, the virus circulated widely in herd animals such as donkeys, sheep and goats.

- Some cases of CCHF occurred in Iraq during the time Hazim ‘Ali was studying overseas and described an incident involving physicians, who unaware of the virus and its symptoms, were unprotected whilst treating infected patients. As a result, some of the physicians acquired CCHF and died. Hazim ‘Ali used this example to illustrate the introduction of the virus into Iraq and that it was not actually endemic to the country.
- According to Hazim ‘Ali, two researchers from the Veterinary Medical College worked together on diagnosing and isolating CCHF in the 1970/1980s. The duration of the experiment and the extent to which testing was conducted using animals, remains unknown. Hazim ‘Ali claims not to know where exactly the practical isolation of the virus occurred because of a lack of sufficient containment to work with the virus and no vaccine was available at the time. The work of the two researchers was published. Isolation of the first case of CCHF in Iraq occurred in 1979.
- In 1996, a CCHF outbreak occurred that resulted in over a 100 cases. Most cases were seen at the Al Khatib hospital, near Tuwaitha, south of Baghdad. The mortality rate even in treated cases approaches 50 percent.

### **Acute Hemorrhagic Conjunctivitis (Enterovirus 70)**

*ISG has investigated, but has found no information to suggest that BW-related research into the contagious agent acute hemorrhagic conjunctivitis (AHCV) occurred after the alleged cessation of the*

*Iraqi viral BW program in early 1991.* The Enterovirus 70 strain that causes AHCV was introduced to Iraq in the 1970s.

- The documented work conducted on isolating AHCV was unsuccessful according to Dr. Hazim ‘Ali. A senior virologist involved in the Iraqi BW program attempted to isolate Rotavirus and AHCV from clinical isolates. When the source isolated AHCV and had evidently obtained cytopathic results, the isolate was infected into Hep2 viro cells. The results of the test were unsuccessful.

### **Rotavirus**

*According to the senior level viral researcher, Rotavirus, which causes an acute gastroenteritis, was chosen because of a theory at the time that as Americans were “more hygienic”, they might be more susceptible to infection with rotavirus.* Little new information has been uncovered by ISG surrounding Rotavirus, the third virus chosen for the Iraqi viral BW program.

- Work was done to isolate the virus from clinical samples but ISG has no additional information to indicate the success of these attempts.

### **Other R&D Related to BW Development**

#### **Biopesticides**

*ISG judges that, following Desert Storm, in mid-1991, Al Hakam shifted its focus from Bacillus anthracis production to Bacillus thuringiensis, a biopesticide and a simulant for B. anthracis, as a mechanism to preserve a key segment of Iraq’s BW production base.* This shift in focus allowed Iraq the opportunity to continue the pursuit of relevant technologies and processes—such as the development of an entirely indigenous growth media and the drying of biopesticide—that could further achieve its desire for self-sufficiency in BW.

- Multiple sources told ISG that in order for Rihab’s former anthrax group to produce Bt, they required the assistance of scientists at TABRC who had

---

## **Bacillus thuringiensis (Bt)**

*Bt is a biopesticide that is widely available on the international market and therefore, trade restrictions aside, it is not immediately apparent why Iraq should choose to develop its own production process from scratch. ISG assesses that there are many companies that would be willing to supply Iraq with Bt and/or sell it a license to produce the material. ISG is unable to find any indication that preproject planning work—market considerations, least cost / most effective method for Iraq to enter the bio-insecticides business—was ever conducted in relation to Bt.*

---

been researching alternatives to chemical pesticides like *B. thuringiensis* since the early 1980s. ISG learned from several sources with direct access that Al Hakam developed *B. thuringiensis* production to cover past anthrax production and to preserve production infrastructure for the future.

- An Iraqi scientist and former head of the anthrax program told ISG that from 1992-1995 TABRC provided the seed inoculums to Al Hakam for industrial-scale production of Bt. However, ISG has no information to suggest that TABRC was involved in production of *B. thuringiensis* in quantities larger than the bench-scale amounts required for experimental purposes.

***ISG judges that the TABRC became the primary facility continuing B. thuringiensis research after Al Hakam's destruction in 1996, but ISG lacks evidence that this research was intended as a simulation for B. anthracis research.*** However, undeclared pieces of equipment including fermentors were found at TABRC by ISG and an important former *B. anthracis* production expert was reported to have worked routinely at the facility from 2000 to 2003, which makes ISG suspicious of the true nature of the work done there.

- An ISG exploitation team found undeclared fermentation vessels and an underground storage area with other dual-use biological production and processing equipment at TABRC in October 2003 (see Figure 7).

- Thamir 'Abd-al-Rahman, who was declared to the UN as involved in Iraq's *B. anthracis* BW project, worked at the TABRC one day a week beginning in 2000 on a SCP project, according to an Iraqi microbiologist with direct access, but unknown reliability. Thamir also was reported to have possibly helped a *B. thuringiensis* researcher at the TABRC, Jabbar Al Ma'dhihi, with some viability tests on *B. thuringiensis*.

Multiple sources told us the primary mission of the TABRC was agricultural science R&D. The majority of TABRC's activities involved crop improvement and integrated pest management. As part of the Iraqi Atomic Energy Commission (IAEC) within the Tuwaitha Nuclear Research Complex, the facility had a mature scientific staff with expertise in recombinant DNA technology, microbiology, entomology, and access to agricultural pathogens, according to an Iraqi microbiologist of unknown reliability.

- Dr. Al Ma'dhihi—former TABRC Director— oversaw research into the biopesticide *B. thuringiensis* and considered it as a replacement for chemical pesticides in Iraq, according to an Iraqi scientist and former head of the anthrax program. Under Al Ma'dhihi's direction, TABRC reportedly conducted successful research into efficient small-scale production and drying of *B. thuringiensis* that could potentially be applied to the BW agent, *B. anthracis*. ISG is uncertain whether informal or formal collaboration between TABRC and the Al Hakam factory occurred before 1991.
- Some of the research into the genetic modification of *B. thuringiensis* done at TABRC in conjunction with the Department of Biotechnology at Saddam University (now known as Al Nahrayn University) from 1999-2003 used polyethylene glycol protoplast fusion methods, followed by screening, to produce a new strain of *B. thuringiensis* that would display high levels of biomass production as well as infectivity, according to an Iraqi microbiologist. ISG judges—based on this research—that the TABRC had genetic engineering capabilities that could be applied to BW agents like anthrax, but have found no evidence to date that such work was done.

---

## Simulants

Generally, 'simulants' are closely related to the BW agent that they are substituting for, but lack the pathogenicity of the BW agent in humans. The rationale for the use of a simulant is that it can be safely used for a variety of purposes such as to accurately assess production methods, storage conditions, weaponization parameters, and dispersal techniques. Many simulants can also be used for a variety of legitimate civilian activities and therefore provide cover stories for BW programs.

---

### Single Cell Protein R&D

ISG has found no direct evidence that the post-1995 work carried out by TABRC into SCP was used to cover continuing research into the production of BW agents, like what was done at Al Hakam. Testing of samples taken during site exploitations at TABRC and its SCP production subordinate, Al Hamath, by a US coalition BW exploitation team were negative for *B. anthracis* and *C. botulinum* (see Figure 8). ISG assessed that a thorough decontamination procedure or, more likely, that no large-scale R&D or production of known BW agents occurred at these facilities.

- An Iraqi microbiologist told ISG that the TABRC's SCP academic research began in the early 1990s and involved research, experimental testing, and pilot plant production. The work also involved the development of a process for upgrading the nutritional quality of the agricultural residues and wastes.
- The Al Hamath facility worked on a project for the pilot plant scale production of citric acid using *Aspergillus niger*. The process was abandoned when it was discovered that the strain of *A. niger* used was unsuitable for use in submerged culture as the mycelium suffered damage under the continual agitation required for submerged culture. Two 750l bioreactors from the abandoned citric acid production project were set aside for SCP work at Al Hamath but only one of the bioreactors was functional.

---

## Single Cell Protein

SCP is cell or protein extracts from micro-organisms, grown in large quantities for use as protein supplements, for example in animal feeds. SCP production is used to alleviate problems of protein scarcity and can be used to replace costly conventional sources such as soy meal and fishmeal. The use of agricultural and industrial wastes for bioconversion to protein rich food and fodder stocks has the additional advantage of making the final product cheaper.

---

### Growth Media R&D

ISG judges that beginning in the 1990s Iraq decided indigenously to research and produce nutrient growth media that could be used to produce multiple strains of bacteria to include **B. anthracis**, but no direct evidence has yet been uncovered that this media was used to produce **B. anthracis post-1991**. Dr. Rihab described to ISG her BW group's research in developing indigenously produced media to circumvent the effects sanctions imposed on Iraq after the 1990 invasion.

- Dr. Al Ma'dhihi was responsible for the development of an indigenously produced media with ingredients that did not come under UN scrutiny as a result of the sanctions against Iraq. Importantly, laboratory notebooks suggest the media was very effective in inducing nearly one hundred percent sporulation of the *B. thuringiensis*, a known simulant for the BW agent *B. anthracis*, with few or no additives or intensive monitoring of the fermentation process.
- During January 2004, ISG obtained a laboratory notebook dating back to 1989 detailing experiments conducted using Dr. Al Ma'dhihi's locally produced milk byproduct/corn byproduct media and the *B. thuringiensis* variant *Kenyae* with impressive sporulation results. The notebook outlined experiments concerning the effect of different concentrations of the media and additives on sporulation of *B. thuringiensis*. These results were consistent with the claims made for the effectiveness of the media. One experiment detailed in the notebook showed that per 24-48 hours growth of *B. thuringiensis* in this locally produced media, there was 100 per cent spore growth with a resulting viable count of  $1.2 \times 10^8$  to  $5.6 \times 10^8$  per milliliter.





*Figure 7. Example of dual-use biological processing equipment found at TABRC (spray dryer).*



*Figure 8. Al Hamath facility.*

- Dr. Al Ma'dhihi's media was essential to a possible Iraqi BW program as the media was made up of the simple local ingredients, which are both by-products of other food production processes. The milk byproduct, in particular, is a waste product. At Al Hakam, the corn byproduct was made from corn-starch produced at the Al Hashimiyah State Factory in Al Hillah near Babylon. The milk byproduct was obtained from an unnamed dairy at Abu Ghurayb. Besides being indigenous and cheap it was impossible to monitor or account as part of a UN verification process.
  - This locally produced media were utilized in the *B. thuringiensis* production process at Al Hakam and with growth requirements of *B. thuringiensis* being very close to *B. anthracis*, the whey/CSL media could potentially have been used at Al Hakam to produce *B. anthracis*. Dr. Rihab and Thamir 'Abd-al-Rahman, the director of the *B. anthracis* project at Al Hakam, have both stated in interviews to ISG that they are unaware of any tests on growing *B. anthracis* in the milk and corn byproduct media. This is an odd statement because both individuals co-authored a document that evaluated various growth media for growing Bacillus species including *B. anthracis* on such a commercially available media.
  - Thamir goes further to state that there was no reason to replace the modified G medium declared as used in the anthrax programs as it was reliable, produced high sporulation rates and was made from simple salts commercially available within Iraq, and therefore there was no need to hide procurement signatures. However, Modified G medium (MGM) cannot be used alone to grow *B. anthracis* spores. MGM requires that the anthrax organism be grown in a very enriched medium first and that relative large inoculums be used in the last step of fermentation that uses modified G medium. Thus using an alternative to the enriched medium and MGM would have a material advantage to minimize sanctions scrutiny. Furthermore, at the time of production of *B. thuringiensis* at Al Hakam, Iraq was under increasing scrutiny on the material balance of growth media from UNSCOM.
- Dr. Rihab admitted to ISG that use of such a locally developed milk and corn byproduct *B. thuringiensis* media would permit evading monitoring of media to track fermentation activity.
- An anthrax expert's assessment was that it was highly probable that this media would achieve similar rates of sporulation in anthrax production.
- Dr. Rihab described to ISG her BW group's research in developing indigenously produced media to circumvent the effects sanctions imposed on Iraq after the 1990 invasion of Kuwait.
- Dr. 'Ali Shihab did media work for an unspecified microbe. Shihab was the lead scientist for *Clostridium perfringens* development. ISG assesses that he was probably working on an alternative growth media for that organism.
  - Nasr Al Hindawi worked on alternative media for *Brucella* that was a candidate BW agent undergoing basic research in the period coinciding with Desert Storm.
  - After 1992, Baghdad University worked on plants as a source of bacteria growth media; the plant media was apparently suitable for pathogen growth, and Dr. Rihab had expressed her concern that it might attract the attention of UNSCOM.
  - Around June 2002, Dr. Al Ma'dhihi produced about five vials of *B. thuringiensis* formulated with bentonite and asked Thamir, who was working with Dr. Al Ma'dhihi twice a week at TABRC, for an assessment of their viability by re-growing them in a small volume shake flask culture. One of Dr. Al Ma'dhihi's MSc students was working on this organism, although no other specific reason for this work was given. Thamir cultured approximately two of the samples, with one of the resulting cultures exhibiting good activity of 80 to 90 percent mortality of test organism, the other performed poorly.

## Drying Process/Carrier/Particle Size

**Multiple sources have told ISG that the *B. thuringiensis* research and production at Al Hakam from 1991 to 1996 was done to provide cover for the equipment and capability at this facility, yet ISG has not been provided with a good explanation as to why an advanced capability to dry agents in a particle size too small for efficient biopesticide use was established.** An UNMOVIC document from March 2003 on Iraq's Unresolved Disarmament Issues says that the particle size would have had little use in agriculture and that UNSCOM determined the *B. thuringiensis* strain used did not produce biopesticidal proteins, so it would not have had any utility as a biopesticide. ISG judges that this work advanced Iraq's expertise and knowledge in large-scale drying of *B. anthracis* even if the agent itself was not produced and dried.

- Iraq successfully dried *B. thuringiensis* utilizing bentonite as a carrier and drying agent. According to a source, only one grade of bentonite was available in Iraq and particle size was dictated by this. The bentonite was supplied through the Ministry of Industry and Minerals (MIM) mining company. Talc was also successfully tested as a carrying agent but was determined to be too expensive for production. Acetone was experimented with at Al Hakam as a drying agent, but was found to be too expensive for large-scale production.
- According to a source, at Al Hakam the dried *B. thuringiensis* was crushed into 1-10 $\mu$ m sized particles but ISG has found no information on who decided on this particle size. The same source claimed that the farmers using the *B. thuringiensis* from Al Hakam did not like the size of the particles since it made direct dusting onto plants difficult. Al Hakam had plans to enlarge the particles to granular size but they had not completed this work when the facility was destroyed in 1996.

Information surrounding the intended application of *B. thuringiensis* remains contradictory with no consensus on whether it was to be applied wet or dry. A senior researcher involved in the BW program has indicated that the *B. thuringiensis* was intended for use against corn borers as a wet or dry application by farmers. Sources are generally consistent in their assertion that the *B. thuringiensis* was never intended or tested for aerial application. Although the information available suggests Iraq successfully dried *B. thuringiensis* and produced the 1-10 $\mu$ m particle size applicable for efficient BW agent dissemination, ISG has found no information that Iraq actually used the same process to produce weaponizable dried *B. anthracis*.

## Production Capability

ISG judges that between 1991 and 1996 Iraq possessed an expanding BW agent production capability. From 1996 to OIF, Iraq still possessed small but significant dual-use facilities capable of conversion to small-scale BW agent production. ISG has found no evidence that Iraq used this capability for BW production.

- Iraq maintained—and tried to improve where possible—a smaller, but capable, “legitimate” fermentation capability at agricultural and educational sites that could have been used to produce small but significant quantities of BW agent. ISG, however, uncovered no information that Baghdad did so.
- Samarra Drug Industries, for example, had the fixed assets that could be converted for BW agent production within 4 to 5 weeks after the decision to do so, including utilities and personnel with know-how and equipment, not all of which had been declared to the UN. Site buildings contain numerous jacketed process tanks ranging in capacity from 100-10,000 liters together with ancillary equipment such as filter presses, autoclaves and bio-safety cabinets.
- ISG cannot disprove the existence of Iraqi transportable fermentations systems that could have been used for BW. That said, no evidence has been found to date that there were such systems. ISG judges that the two mobile trailers found near Mosul and Irbil were not for BW production (see the accompanying annexes on mobile production facilities for further information).

***Iraq relied heavily on imported equipment and supplies to conduct its BW program, was dependent upon dual-use civilian facilities to produce BW agent, and took steps to mitigate the impact of sanctions on its ability to pursue potential BW agent production.***

Iraq relied on equipment that had been imported for civilian purposes for the production of BW agent prior to the first Gulf war, and demonstrated the ability to quickly adapt civilian facilities to BW agent production. This equipment was relocated to a purpose-built BW facility, Al Hakam, where the

production of botulinum toxin was started in 1988. The production of anthrax spores and *C. perfringens* (the causative agent of gas gangrene) followed later. Civilian facilities were requisitioned in 1990 for the production of aflatoxin (the Agriculture and Water Resources Center, Al Fudaliyah) and for the production of additional quantities of botulinum toxin and possibly anthrax (the Foot and Mouth Disease Vaccine Plant, Al Dawrah). After the war these facilities reverted back to their former use, and Al Hakam was disguised as a SCP (yeast) and a *Bacillus thuringiensis* (biopesticide) production plant.

- Prior to the construction of Al Hakam, alternative locations and options were considered by the Iraqi authorities. This included the possibility of having mobile production facilities. Pre-OIF intelligence reports indicated that Iraq had such facilities.

***Baghdad’s BW production centered on a number of important fixed facilities. The facility at Al Hakam was perhaps the most important, but Iraq pursued BW in a range of locations.***

Iraq initiated production of BW agents (for field tests) at Al Salman in 1987 using seven laboratory fermentors (7- and 14-liter vessels) and two small production fermentors. Regarding the two small production fermentors, one was acquired in 1987 from the At Taji single cell protein (SCP) project (300 liter) and the other was a 150-liter fermentor purchased while the program was at Al Muthanna. A medium capacity spray dryer also was transferred from the At Taji SCP Plant to the BW program in 1987.

After the Al Hakam facility (northern production area) became functional in 1988, the 300 liter and 150 liter fermentors were transferred to the new facility. Additionally, a larger scale production capability was acquired by moving the Clostridial vaccine production line from Al Kindi Veterinary Research Facility (later named the Veterinary Vaccine and Drug Production Facility [VVDP]) to Al Hakam. This collection of fermentors and tanks—reported by the supplier to be fermentors—consisted of two 1,850-liter fermentors, one 1850-liter tank, and six 1480-liter “tanks” and eight 800-liter mobile “tanks.” The 1,850-liter fermentors and six 1,480-liter “tanks” were all used in production of BW agents. Iraq asserted the mobile

tank was used only for storage and transport of bulk agent. A second spray dryer that could produce small particles—one of two air-freighted from a supplier to Baghdad in 1989—was located at Al Hakam at the time of its first UN inspection in September 1991.

In 1990, additional production capability was acquired for the BW program with the addition of Al Safa'ah (Agriculture and Water Resources Center at Fudaliyah) and Al Manal (Al Dawrah Foot and Mouth Disease Virus (FMDV)) facilities to the BW program. Al Safa'ah possessed a sizeable fermentation line consisting of several 400-liter fermentors and associated other tanks. Additionally, the facility had several incubators including one walk-in incubator, which allowed for some creative stacking of glass flasks said to be used for aflatoxin production. Al Manal had valuable high containment capacity for R&D and contained: one 125-liter mobile tank; one 141-liter and one 236-liter seed fermentors one 1,425-liter and two 2,100-liter fermentors; two 2,550-liter mobile tanks; two 2,600-liter, two 2950-liter, and two 3,500-liter fermentors. Of these, assortments of 2,600-liter and 3,500-liter fermentors were used to provide a capacity for 1,200 liters (10X concentrated) of agent per batch (not all of the available capacities were said by Iraq to be used in this production process) (see Figure 9).

Additionally, other sites had production capability of a more limited scale, e.g. Al Kindi Veterinary Research Laboratories (Al Kindi VVDP facility) and Al 'Amiriyah Serum Vaccine Institute (ASVI), or capability that would require modification on a limited scale, e.g. Samarra Drug Industries. The Al Kindi VVDP facility retained one 1,850-liter tank—damaged during Desert Storm, when the other tanks and fermentors were transferred to Al Hakam. Production for viruses and bacteria employing glass flasks and embryonated eggs were less efficient but ample.

- Iraq declared work on larger-scale fermentation systems for SCP, and on a capability to produce large-scale quantities of a commercial biopesticide in the first UNSCOM inspections in the years immediately following the 1991 Gulf war. Many former officials told ISG that Iraq aggressively worked from 1992 to 1995 at Al Hakam to improve the production and processing of SCP and the biopesticide *B. thuringiensis* in an attempt to save the facility from being destroyed by UNSCOM.

From 1991 to 1996, Iraq continued to expand its dual-use production capability at Al Hakam—until the facility and equipment were destroyed under UNSCOM supervision in May-June 1996. Fermentors and associated equipment were transferred from Al Safa'ah to Al Hakam. Indigenously produced fermentors, 2.5 cubic meters and 5 cubic meters, were installed in the southern production area. These were assessed by international experts as “not fancy but functional” although Iraq has stated to ISG that the 5 cubic meter fermentors were not functional due to propeller shaft problems. Large physical plants were constructed in anticipation of acquiring two 50 cubic meter turnkey fermentation systems. These were not delivered.

**To avoid sanctions imposed after Iraq's invasion of Kuwait, Iraq initiated a program to develop the in-house manufacture of media and media components suitable for the growth of bacterial BW agents, see Section on R&D. ISG site exploitations have revealed sites with the potential to undertake growth media production.**

- The large-scale production of bacterial BW agents is a multi-stage process that requires a growth medium suitable for the selected organism together with a ‘train’ of specialty, and fermentation equipment. Because of sanctions and UNSCOM inspections, beginning in 1990 Iraq had difficulty obtaining an external supply of growth media for large-scale production of BW agent. By 1992, UN inspections, mandatory declarations and UN monitoring of growth media importation and use created further impediments for any Iraqi biological production effort. Rihab apparently began an effort in 1990 first with some of her BW researchers, and then later with at least one scientist at the IAEC TABRC, to develop bacterial growth media from indigenous sources. Rihab stated that when the effort was initiated in 1990, the intent was to circumvent sanctions placed on Iraq. ISG does not have evidence that this effort was originally intended to enable clandestine production of BW agents, but nevertheless provided some capability in this regard.

The production capabilities at Tuwaitha continued to expand during this period. The FMDV Plant at Al Dawrah remained functional until it was partially disabled under UN supervision in 1996; selected fermentors and tanks—identified as used in botulinum toxin production in 1990—were removed from the facility and destroyed at Al Hakam in 1996.

Other facilities at Al Kindi VVDP Facility and ASVI recovered and made modest improvement in production capability as did Samarra Drug Industries (SDI). During this time frame two new organizations—Al Razi Institute and Ibn-al-Baytar—were established in converted facilities. These organizations obtained highly qualified expertise, some of which were associated with the Iraqi BW program including Dr. Hazim ‘Ali, who headed Iraq’s viral BW effort and was named Director of Al Razi Institute.

***Beyond its important fixed facilities, Iraq also possessed important relocatable assets associated with its BW production efforts. The destruction in May-June 1996 of the facilities and equipment involved in Iraq’s BW program, including the equipment that had been moved or installed at Al Hakam post 1991, significantly altered Iraq’s dual-use capability, but did not eliminate all such capability.***

At the Al Dawrah FMDV Plant, one 2,600-liter, two 3,500-liter, and one 236-liter fermentor as well as one 2,550-liter mobile tank were not destroyed under UN supervision in June 1996. These fermentors and tanks were not identified in 1995/96 by UNSCOM as involved in Iraq’s BW program. However, DNA evidence of *B. anthracis* was found in both 2,550-liter tanks and a 141-liter fermentor in 1996. All of these fermentors and tanks could be transferred from the FMDV facility to another site or sites within a few weeks after the decision to do so. ISG assesses these as relocatable production assets.

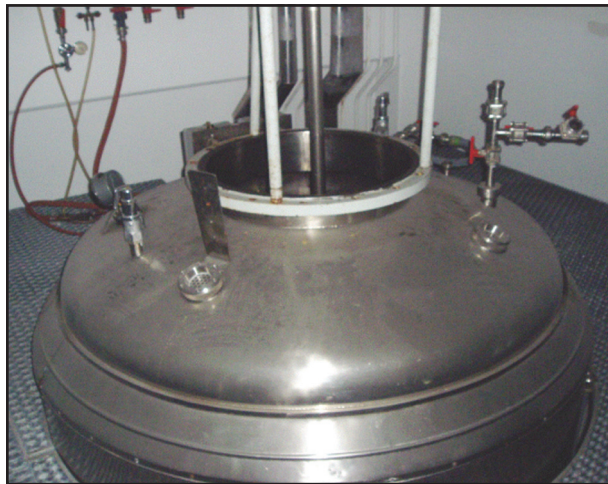
In 1990, Iraq produced at least 39—possibly as many as 70—1,000-liter mobile tanks that could be readily converted into fermentors. Additionally, 8 mobile 800-liter tanks/fermentors were transferred from Al Kindi Vet Vaccine Facility to Al Hakam in 1987/88. Of the combined 1,000-liter and 800-liter mobile tanks, only 24 were cited as destroyed by Iraq. Evidence of such destruction of 24 units was provided

to UNSCOM and stored at the UN Headquarters in the Canal Hotel. Thus, 23 remained after the alleged unilateral destruction of BW weapons and agents by Iraq in 1991. ISG has determined that two more tanks were destroyed at Al ‘Aziziyah. Of those remaining, four are 800-liter imported tanks/fermentors.

- Rihab stated that Iraq was able to produce one cubic meter model fermentors “with bad wheels”. Documentary evidence dated September 2000 recovered by ISG indicates that Iraq converted one cubic meter storage tanks into fermentors that are assessed to have been indigenously fabricated for Al Hakam under Rihab’s supervision. These storage tanks have been an unresolved issue for the UN. Rihab denied receiving mobile tanks/fermentors while at Al Hakam in 1994.
- ISG obtained a document that indicated 10 one cubic meter tanks were connected prior to 2000 to form a 10 cubic meter fermentation plant (location unknown). Another document indicates the delivery of an additional 13-14 such tanks in 1993.

A spray dryer—the second of two air freighted into Baghdad in 1989, model number 0142 was located in 1997 by UNSCOM in a warehouse in northern Iraq, the first model 0141 was at Al Hakam in 1991 and was destroyed in 1996. Before the two weeks it took to assemble a sampling team, Iraq again relocated the dryer, completely disassembled it to cleanse and sterilize it and then reassembled it. This dryer was under monitoring until 15 December 1998 by UNSCOM. Its present whereabouts is unknown.

***ISG judges that after 1996, Iraq maintained—and tried to improve where possible—a smaller, but capable, “legitimate” fermentation capability at agricultural and educational sites that could have been used to produce smaller, yet significant quantities of BW agent, but ISG has found no direct evidence to substantiate this possibility.***



**Figure 9.** Sign at the entrance to FMDV “Almanai” (top left), vial of vaccine dating from 19 October 1983 (top center), and a main production fermentor (top right). Top plate of 3,500-liter bio-reactor (bottom left), and 236-liter bio-reactor (bottom right).

## Break-Out Production Capability Pre-OIF

*ISG judges that a break-out production capability existed at one site, the State Company for Drug Industries and Medical Appliances, SDI, at Samarra. Since Iraq could relocate production assets such as fermentors, other sites with basic utilities could also be converted for break-out. A full program to include R&D and production or even just large scale production would require months rather than weeks to re-initiate in a break-out context.*

A break-out of large-scale proportion would require all three key production elements; fermentor capacity, media capacity, and technical expertise. A break-out capability must also take into consideration the scale and scope of the program being considered. Modest or small-scale break-outs would be easier and require less time after a decision to do so was made. For a larger scale and scope such as Iraq possessed in 1990 would require more equipment, larger supply source, more personnel and a longer time period for effective start-up. Iraq, having had achieved a maturing program, had a core group of experienced personnel; a better start than existed in 1985. Personnel are movable assets as is growth media. While sanctions and inspections may be a hindrance to an ample supply of media, it would not have been a show stopper. Iraq developed a milk and corn byproduct media that is judged to be adequate for the production of anthrax spores, albeit of a reduced production efficiency. Thus, the equipment for the scale and scope of a program becomes the critical factor to evaluate a break-out capability.

ISG assesses the SDI to have the fixed assets that could be converted for BW agent production within four to five weeks after the decision to do so, including utilities, personnel with know-how, and the equipment (with slight modifications) required. Media and additional less-skilled personnel could be obtained (see Figure 10).

ISG judges the movable assets at the Al Dawrah FMDV Plant could provide the core of an alternative break-out capability at any other suitable site in Iraq, perhaps within 2 to 3 weeks after the decision to do so. The 1 cubic meter tanks or fermentors presently unaccounted for are other important assets that, if indeed still exist, could, when combined with the Al

Dawrah FMDV assets, exceed the capacity Iraq possessed in 1990. In this case media and personnel are also movable assets.

- Iraq had shown the ability to move fermentor assets pre-1990 era. Iraq had also shown its ability to utilize small cadres of skilled personnel to lead clusters of less skilled personnel in the production process.
- Iraq gained additional production and development know-how during the post-1991 era.
- Iraq has developed the capacity to produce indigenously, substitute media for the production of some agents, such as corn and milk byproduct media for anthrax spores.

*ISG judges that *Bacillus anthracis* (anthrax) would likely be the agent of choice for breakout production.*

- It represented the single strategic BW agent that Iraq had in its historical arsenal.
- Iraq has a previous track record in large-scale growth, processing, testing and weaponization of anthrax spores.
- Corn byproduct medium, indigenously manufactured for Bt production, would also be suitable for the growth of *B. anthracis*.

## Mobile Assets

Prior to OIF, a key source reported that Iraq had developed a mobile BW capability designed to evade UN inspectors and to provide Baghdad the ability to produce BW agents for offensive purposes (see Figure 11). According to the US Intelligence Community, this reporting was augmented by reports from at least three additional sources who indicated a mobile BW or fermentation capability existed in Iraq. The reported development of a mobile BW agent production capability was a central element in the pre-war assessment of Iraq's WMD programs and, as a result, has been one of the key issues addressed by ISG.





*Two 1,000-liter, stirred, jacketed vessels suitable for use as fermentors for the growth of bacterial BW agents.*



*Autoclave with control panel.*



*Plate filter press.*



*Production hall with tiered vessels of Soviet origin not declared to the UN.*



*High grade water production plant.*

**Figure 10.** *Examples of equipment found at SDI that could be diverted to BW purposes.*



**Figure 11.** Truck-mounted BW production unit-based on source reporting.

Regarding the mobile capability, ISG's BW team has focused primarily on following leads from the key source and the others with indirect or direct access to Iraq's BW activities to bring us closer to an assessment as to whether Iraq did indeed pursue an undeclared mobile BW agent production capability. The ISG effort consisted of debriefing over sixty individuals and exploiting numerous sites identified as related to a transportable BW production effort. However, ISG acknowledges that much of the site exploitation effort was hampered by Iraqi post-OIF activities such as turnover of employees and looting. Based on information collected by ISG, the key source was determined to be unreliable.

- Debriefings and site visits have uncovered information that differs with pre-OIF reporting, including denials of the existence of the program from personnel allegedly involved. ISG has exhausted many leads and exploited many sites reportedly pertaining to Iraq's alleged mobile BW agent production capability and have obtained no additional evidence to corroborate the claim of the existence of a mobile BW program. As for other individuals that alleged the existence of a mobile BW capability, ISG has not been able to corroborate this reporting and believe that these individuals are outside of Iraq.

***ISG cannot disprove the existence of Iraqi transportable fermentation systems that could have been used***

***for BW, but ISG uncovered no evidence that there were such systems. A report covering the detailed investigations of ISG is attached as Annex 3.***

As part of its investigation into a possible Iraqi mobile BW agent production program, two mobile trailers that were recovered near Irbil and Mosul in 2003 have been examined by ISG. These trailers had tanks or suspected fermentors on board and were initially suspected to be part of a mobile BW agent production program. ISG judges that its Iraqi makers almost certainly designed and built the equipment exclusively for the generation of hydrogen. ISG judges that it is impractical to use the equipment for the production and weaponization of BW agent, and cannot therefore be part of any BW program. A report covering the detailed investigation of the trailers by ISG, is attached as Annex 4.

- ISG has found no evidence to support the view that the trailers were used, or intended to be used, for the production of BW agents, or the filling of BW weapons.
- The design of the equipment makes it unsuitable for the production of BW agent and impractical as part of a BW weapons production system.
- The information gathered, and the assessment of the equipment on the trailers, are consistent with the theory that Iraq developed the trailers for hydrogen gas production.

These findings reflect the assessment solely of the two specific mobile units that were located, and do not necessarily mean that such a capability or intent did not exist.

## Weaponization

*Between the late 1980s and the start of Desert Storm in 1991, Iraq attempted to develop a range of systems for the dispersion of BW agent. In the dash to field viable BW weapons the workers in the program adapted robust bombs capable of mounting on many types of aircraft and warheads, including the Al Husayn missile. They also worked furiously to ready an aircraft spray system.*

- The scientists and engineers conducted weapons trials over some three years with both simulants and BW agents, on occasion using living animals as targets. Delivery systems tested included a helicopter-borne spray system, aerial bombs, artillery shells, multi-barrel rocket launchers, long-range missile warheads and an aircraft mounting of an adapted auxiliary fuel tank.
- In the haste to prepare for the 1991 conflict, systems tried and tested with CW agents were preferred; the R-400 aerial bomb and the Al Husayn warhead, charged with anthrax, botulinum toxin and aflatoxin. Additionally, engineers at Al Muthanna rushed the auxiliary fuel tank, modified into a spray system, of the Mirage F1 aircraft into service (see Figure 12).
- Prior to Desert Storm, Iraq had dedicated complimentary programs to develop spray technology that could effectively disseminate either CW or BW agents. These spray dispersal systems were intended for use in conjunction with various developmental unmanned aerial vehicles (UAV) programs. Initial testing was quickly beginning to show progress by the time of Desert Storm. Since that time however, while their desire for these systems remained, their developmental work shifted focus. Due to the attention of the UNSCOM inspectors, the developmental effort shifted away from the more controversial spray technologies toward completing the longer range UAV goals.

*ISG judges—with important reservations—that the former Regime clandestinely destroyed almost all of Iraq's biological WMD and long-range missiles in 1991. Numerous interviews with high-ranking Iraqi political figures, WMD scientists, and military and security officers indicate that after a brief period of concealment in 1991, Iraqi leaders decided to destroy Iraq's undeclared weapons stockpile in secret.*

- Shortly after the passage of Security Council Resolution 687 in early April 1991, Iraqi leaders also decided to erase all traces of the offensive BW program.
- By the autumn of 1991, Iraq probably accomplished both the destruction of the weapons stockpile and surviving evidence of the BW program.
- Interviews conducted by ISG have produced a reasonably coherent picture of this unilateral destruction, with few conflicting details, although important questions about the disposition of bulk BW agent and bacterial reference strains remain.
- ISG judges that the former Regime destroyed most of its hidden stockpile of BW weapons. A few pre-1991 weapons probably either escaped destruction in 1991 or suffered only partial damage. It is thus possible that a few more will be found in the months and years ahead.

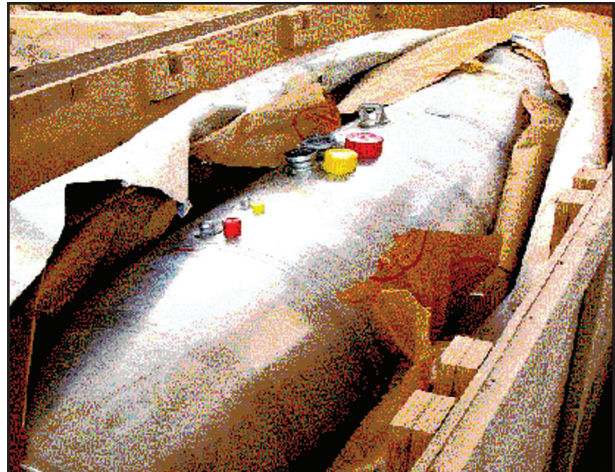
ISG bases its reservations on the following factors:

- The security situation in Iraq has limited the physical verification of Iraq's unilateral destruction claims—by excavating and counting weapon fragments, for example.
- Many of the officials interviewed by ISG had previously lied—or told half-truths—to UNSCOM, and they may have lied to ISG as well, though ISG assesses that most were being open and truthful.
- The continuing exploitation of Iraqi documents may produce evidence that contradicts the assertions of the Iraqi officials.
- The efforts of the Iraqi Interim Government and Coalition forces may yet result in the discovery of unacknowledged WMD stockpiles left by the former Regime, though ISG judges this to be very unlikely.

*ISG has not discovered any evidence that Iraq has conducted research or trials dedicated to the dispersion of BW agents since declaring its offensive program in 1995. Iraq pursued some delivery systems projects until OIF that could have provided some BW utility and whose origins lay in the development of BW and CW dispersion systems.*



*Al-Aziziyah: R-400 bomb fragments.*



*Al-Asad: new Mirage FI drop tank (France).*



*Al-Asad: drop tanks (Russian).*

**Figure 12.** *Examples of possible BW delivery systems.*

- Iraq continued to develop delivery platforms for small payload weapons up to OIF. ISG has not identified any specific payloads for these systems. By their nature, these platforms were expensive and limited in number. They would have far greater utility for special weapons, such as BW or CW agent or radiological material, rather than conventional warheads. The Delivery Systems Team has reported on UAV that operate autonomously and remotely piloted vehicles (RPV) that were operated from a ground station. The L-29 RPV was the latest development of a concept that commenced in the Technical Research Center

(TRC), the home of Iraq's BW program in the late 1980s. After the L-29, Iraq continued to work on the development of UAVs and RPVs, the Al Quds being one example.

- Although the Iraqis made significant initial progress in their spray dissemination programs, disregarding the definite adverse impact in their research from Desert Storm, they were still significantly short of the target goal. Perfecting just the sprayer technology—such as optimizing tank pressures, nozzle designs for droplet size and concentrations, together with determining operational flight envelopes—for

use with either a chemical or a BW mission in mind was still years from fruition. The aircraft or UAV carrier platforms also were far from being completed. However, the “know-how” and the same “experts” still existed and the technology necessary is largely duplicative with agricultural uses. Therefore, it was potentially just a matter of iterative analysis and experimentation to achieve a capable CBW spray dissemination system.

### Attempts at BW Weaponization

In common with much else in Iraq’s BW program, progress was steady and planned, except when the exigencies of impending war forced a convulsive change of pace and direction. Thus, having toxicological and production aspects in hand, some scientists and engineers turned their attention to weaponization. Starting with small-scale animal tests using small quantities of agent dispersed using a detonator in a confined space they progressed, step by step, toward full-scale weapons trials using viable BW agent. Dr. Rihab and her team, assisted by MIC consultants, evaluated many types of weapon. The initial trials were modest and used a BW agent simulant. Next, individual weapons charged with viable BW agent were fired statically. Eventually, trials used salvos of rockets at their operating range. The rationale for the choice of weapon types and agents is a matter that, even now, Iraqis are reluctant to talk about. Al Muthanna organized the trials and advised on the weapons technology. As a result, the thinking appears to have followed CW lines. Until the imposed requirement to weaponize at pull speed in 1990, the latter field trials aimed at amassing data for the delivery of anthrax. This may have been an attempt to provide a means of denying ground in front of an invading enemy, and would parallel the use of CW agents such as mustard. Following the instruction from Husayn Kamil these trials stopped and efforts switched to longer range delivery systems such as aircraft bombs and sprays and ballistic missiles.

**Aerial Bombs.** Dr. Al Hindawi and Dr. Rihab state that their first weapons-related field trial consisted of the explosive detonation of two cylinders representing munitions containing a simulant. A trial using an Iraqi manufactured LD-250 aerial bomb charged

with botulinum toxin followed in March 1988, using animals on a grid as a target. They reported repeating this trial later the same month. ‘Zubaydi’ Helicopter Spray Device. As early as 1987 under the auspices of the residual Al Hasan BW program at Al Salman, Iraq started efforts to develop BW aerosol dissemination systems. Dr. Tariq Zubaydi, a university professor interested in “detecting bacterial organisms in the air,” coordinated these tests. He had proposed reverse engineering a nebulizer system. In time, his work led to developing better spray systems in support of his research. TRC was keen to exploit his research for BW purposes. The first known field test occurred in July 1988 at Khan Bani Sa’ad. These early tests involved rotary sprayers mounted on a helicopter.

**Artillery Shells.** According to one of the scientists involved in TRC’s Ricin program, Dr. Lu’ay Qasim, Al Muthanna technicians detonated four 155 mm artillery shells filled with the agent in a ground test at Jurf as Sakhr.

**122 mm Multi-barrel Rockets.** In the following year, 1989, the TRC team, assisted by Al Muthanna, was investigating the dispersion achieved by individual rounds and salvos from 122 mm multi-barrel rocket launcher systems. Weapons were filled with Botulinum toxin, aflatoxin, wheat cover smut spores, and simulants.

**Fixed-Wing Aircraft Spray Systems.** The “Thul-Fiqar” project started in November 1990, soon after the publication of an Israeli newspaper article described how an aircraft with a biological weapon could kill the majority of a target population under favorable conditions. Husayn Kamil ordered Al Muthanna to develop a capability to disseminate a BW agent from an aircraft. As a result, two independent working groups were established; one group consisted of experts from Al Muthanna, the Technical Research Center (TRC) and the Iraqi Air Force, while the other group was restricted to the Military Research and Development Center (MRDC) at Baghdad’s Al Rashid Airfield. These projects may have their origins in CW rather than BW. In a letter dated 10 December 1990, Gen. Fa’iz Shahin, DG of Al Muthanna, writing to Husayn Kamil, referred to “successful tests of spraying mustard gas by planes which proved to be very effective.” This may account for the speed with which Al Muthanna was able to advance with this task.

- ***Mirage F1 Auxiliary Fuel Tank Spray System.*** The Al Muthanna group worked on modifying Mirage F1 auxiliary fuel tanks to disperse the BW agent. The first tank modified contained an electric fuel valve adapted to feed agent through a crude venturi outlet. This tank was installed on a Mirage F1 and one field test was performed at Abu 'Ubaydi Airfield near Al Kut. This unsuccessful test led to more tanks being modified for testing by adding two more valves and outlets and strengthening the structure of the tank. Various combinations of water with other additives were tested with differing degrees of success. It eventually was determined that under proper circumstances (correct combinations of additives and flight conditions), acceptable results were achieved (i.e., the liquid dispensed was deposited on the ground in the testing areas as planned). However, when simulated BW agents were then tested, the results were unsatisfactory.
- ***MiG-21 RPV.*** A senior NMD official recently reported on his pre-OIF research of the 1990-91 MiG-21 RPV development project and the associated Mirage F-1 CBW spray tank project, as well as the later L-29 RPV project. The purpose of the research was to prepare the NMD to respond to urgent requirements from UNMOVIC. The NMD official said his investigation confirmed that the MiG-21 RPV had been intended for a mission to deliver CBW agents and that the Mirage F-1 project was a related effort to develop an aircraft-mounted CBW spray tank. While the MiG-21 RPV effort failed, the Mirage F-1 spray tank development, on the other hand, was considered successful. While varying in some minor details concerning the timing of some test events, this NMD official essentially corroborates the UNSCOM report.

## **The Gulf War**

By the start of the 1991 Gulf war, Iraq had produced significant quantities of BW agents. The weaponization of these agents demonstrated a rudimentary understanding of BW weapons and agent dissemination. Dr. Mahmud Farraj Bilal Al Samarra'i, the Al Muthanna official who headed the effort to weaponize CBW agents, described this aspect of the BW program as 'immature'. Iraq had no operational experience with these agents or BW weapons, had limited delivery systems to employ them, and had no practiced employment doctrine. Dr. Bilal's philosophy was to adapt chemical weapons for BW agent use. Though Iraq had made initial efforts toward the development of more advanced aerosolization technologies, senior BW managers dismissed this approach in favor of tried and tested CW systems.

Based on an apparent press article, Husayn Kamil and his Deputy 'Amir Hamudi Hasan Al Sa'adi directed a compartmented program to develop aircraft spray tanks and modify a MiG-21 jet aircraft into a remotely piloted vehicle (RPV). Iraq conducted several successful field trials using a modified 1,100-liter fuel tank mounted on aircraft. The UAV effort failed to reach an operational developmental prototype prior to 1991.

ISG recovered documents that provided insight into Iraq's perceived success in BW weaponization. According to 'Amir Al Sa'adi, who coincidentally evaluated Dr. Rihab's professional work, he annotated her award nomination package in 2000 and cited the conventional explosive dissemination munitions, aerial bomb, artillery, and rockets as inactive. He judged efforts for spray system as not reaching weaponization with the research as incomplete.

## Concealment And Destruction of Biological Weapons

### Iraq's Initial WMD Concealment Effort

*UNSCR 687, approved on 3 April 1991, required Iraq to disclose fully its weapons' programs and stockpiles, yet the former Regime decided later that month only to declare partially their programs and weapons.*

- In the week following the passage of UNSCR 687, MIC Senior Deputy Dr. 'Amir Al Sa'adi convened a meeting of all the senior managers from the missile, chemical, nuclear, and biological weapons programs. These program heads brought with them inventories of weapons, missiles, launchers, accessory equipment, bulk agents, raw materials, and production machinery, along with recommendations of what to declare and what to hide.

Al Sa'adi and the program heads wrote a paper detailing a series of options for Iraq's response to the resolution. These options, according to Al Sa'adi, included:

- Declaring everything and actively cooperating with inspectors.
- Declaring all sites and weapons but saying nothing about activities under development such as the nuclear program, and not volunteering information responding to questions when asked.
- Hiding everything. They based this option on the Coalition's claim that it destroyed everything during the war.
- A fourth option may have called for Iraq to make a simple declaration of a few lines and to let the UN respond with clarification of what was required.
- One or two of the options contained a provision that Iraq should unilaterally destroy the biological program. Another option called for Iraq to declare only BW research and development work.

Al Sa'adi submitted the options to Husayn Kamil, not directly to Saddam. Husayn Kamil later gathered Al Sa'adi and several of the program heads and gave them instructions regarding the declarations. He did not base his instructions on a single recommended option but contained elements from several options. After the initial declaration in April, Iraq also submitted a more detailed declaration in May 1991.

- Whether Saddam was involved in the decision is not clear, though ISG judges that he was probably involved. Once Husayn Kamil made the overall policy for the declarations, Al Sa'adi, in consultation with the program heads, decided which weapons and programs to declare.

Senior Iraqi officials have stated several reasons for Iraq's retention of weapons and its failure fully to declare its programs.

- Husayn Kamil decided that a full declaration—to include the nuclear and BW programs— would be embarrassing to Iraq and would bring undesired international scrutiny, according to one participant in the April 1991 meeting.
- Former Deputy Prime Minister Tariq 'Aziz stated that Husayn Kamil originally wanted to keep the concealed, undeclared weapons for use in the future, and he speculated that Kamil probably wanted to use them against the United States, Israel, or Kuwait.
- Former Oil Minister and MIC Deputy, 'Amir Muhammad Rashid Al 'Ubaydi, speculated to ISG that Iraq did not declare all of its weapons in order to maintain a deterrent against the United States, which continued to menace Iraq from Kuwait and southern Iraq at the time of the initial declaration.
- Another official believed that Iraq's decision not to declare all of Iraq's weapons came from Saddam who was afraid of Iran, Israel, and perhaps other neighbors. Post-war Iraq was unstable, and Iraq found itself in a helpless and defenseless position.
- Another official believed Iraq retained missiles and launchers because Iraq was experiencing serious Iranian-instigated security problems—the 1991 Shia uprising— and Iraq wanted to keep the missiles in case war developed with Iran.

- In the period shortly after the passage of UNSCR 687, most Iraqi officials did not think that the resolution would be vigorously applied, and they expected that inspectors would only operate in Iraq for a couple of months.

***Because of Husayn Kamil's decision in April 1991, Iraq only partially declared its holdings of chemical weapons and missiles, while it did not declare its biological and nuclear weapons program at all. Iraq concealed the undeclared weapons to varying degrees.***

- Iraq concealed between 128-157 R-400 bombs containing BW agent at Airfield 37 in western Iraq and at Al 'Aziziyah to the southeast of Baghdad.
- Iraq also concealed 25 biological agent-filled Al Husayn missile warheads; 15 in the embankment of the Tigris Canal northwest of Baghdad, and 10 warheads in the Al Mansuriyah former railway tunnel to the northeast of Baghdad. These warheads contained botulinum toxin, *Bacillus anthracis* spores, and aflatoxin, though the number filled with each agent is still uncertain.
- Iraq also concealed an undetermined amount of bulk BW agent at a succession of locations around the periphery of Baghdad.

## **The Destruction of Iraq's BW**

***An IAEA inspection in late June 1991 triggered Iraq's decision unilaterally to destroy the undeclared weapons that had been concealed from the UN, according to multiple senior Iraqi officials.***

The IAEA's inspection team was blocked from sites in Abu Ghurayb and Fallujah. The Iraqis fired warning shots over the inspectors' heads, but the inspectors brought back photos indicating Iraq was hiding undeclared uranium enrichment equipment from the inspectors.

- The IAEA inspection and the international uproar surrounding it caused consternation and a measure of panic in the Regime's leadership, particularly Husayn Kamil, and Saddam appointed a high-level

committee headed by Deputy Prime Minister Tariq 'Aziz to deal with inspection matters, according to multiple sources.

- A senior Iraqi scientist who directed the destruction of chemical and biological munitions contends that the decision to destroy the hidden materials was made at the end of June 1991. The IAEA inspection and the ensuing controversy prompted Iraqi concerns about renewed war with the US, according to Dr. Bilal. 'Amir Rashid telephoned Dr. Bilal and ordered that all hidden chemical and biological munitions be destroyed within 48 hours. When Bilal responded that this was impossible, 'Amir Rashid directed that Bilal use the resources of the Iraqi Air Force and the surface-to-surface missile force to accomplish the task. Dr. Bilal gathered his colleagues from Al Muthanna, went to the locations of the stored munitions, and began the destruction.

***Interviews with high-ranking political figures, managers of military industries, WMD scientists, and disarmament officials indicate that Iraq decided in the spring of 1991 to eliminate evidence of the BW program.*** All the interview subjects agree that Iraq accomplished this elimination by the autumn of 1991, though there are still important questions about the timing of the effort, the amounts and origins of material destroyed, and whether Iraq initially planned to retain a stock of BW.

The Iraqi leadership regarded the BW program as politically dangerous for Iraq and made the decision to destroy the BW program, according to Tariq 'Aziz.

- Husayn Kamil actually made the decision to destroy weapons and evidence of the BW program in April at the same time that he decided not to declare the program, according to NMD head, Husam Amin.
- In early May 1991, Husayn Kamil verbally ordered Technical Research Center (TRC) head Ahmad Murtada to destroy all biological agents, along with all documentation for their research, development, and production, according to Dr. Rihab.



- Former MIC director ‘Amir Rashid also indicated that the destruction decision came from Husayn Kamil, who then relayed the decision through Al Sa’adi and himself, to TRC head Murtada for execution.

The BW program’s destruction occurred in three distinct phases:

- The cleanup and sterilization of research and production facilities, including Al Salman, Al Hakam, Al Manal (Al Dawrah, FMDV Plant), and Al Safa’ah (Al Fudaliyah)
- The destruction of munitions by the TRC Biological Group and Al Muthanna personnel
- The deactivation and dumping of bulk BW agent.

Concealment of the production aspects of the BW program required the thorough cleanup of Iraq’s BW research and production facilities, which reportedly began shortly after the destruction decision. Cleanup was completed prior to the arrival of the first UNSCOM BW inspection in August 1991, according to TRC head Dr. Ahmad Murtada.

- The TRC T-3 BW research and development facility at Al Salman, located three kilometers south of Salman Pak, which Coalition bombing had badly damaged during the 1991 war, was further destroyed with explosives, and the site graded and landscaped. A review of reporting from the summer of 1991 indicates this activity began in early July 1991 and was complete by the end of that month.
- The Al Manal production facility was cleaned up, equipment not originally part of the facility was taken to Al Hakam, and the site returned to its original owner—before the first UNSCOM inspection in May 1991, according to Dr. Rihab, although MIC did not formally relinquish control until July 1991.
- Al Hakam, one of Iraq’s major BW agent production plant, was not damaged during the 1991 war, and Husayn Kamil sought to maintain the facility—with its specialized equipment and work force—by creating a civilian cover story to explain the presence of the large-scale production equipment. The plant was converted for production of biopesticide and single cell protein.

Iraq destroyed its BW weapons in the summer of 1991, according to multiple sources.

- Dr. Bilal of Al Muthanna was responsible for destroying the BW–R-400 aerial bombs and Al Husayn missile warheads—because no one within the TRC T-3 Directorate had any experience with weapons, while Al Muthanna personnel were very familiar with them. Bilal was assisted by Sinan ‘Abd-al-Hasan Muhi Mustafa Al ‘Ubaydi and Isma’il Ahmad Salih Bashir Al Bashir of TRC.
- There were two sites within the ‘Aziziyah bombing range for the destruction of the R-400 BW bombs—possibly 133 or 134 of them, according to Dr. Bilal. Deactivation of the agent within the bombs with formalin and potassium permanganate (for botulinum toxin and anthrax bombs) or bleach (for bombs containing aflatoxin) was followed by destruction of the bomb casings with explosives.
- The Al Husayn BW warheads were chemically deactivated by Al Hakam personnel at their storage sites (the Tigris Canal embankment and the Al Mansuriyah former railway tunnel), then taken to An Nibai and destroyed with explosives, according to Bilal and Rihab.
- Iraq’s BW declaration indicated Iraq had 157 R-400 BW bombs (100 botulinum toxin, 50 anthrax, and 7 aflatoxin) and 25 Al Husayn BW warheads (5 anthrax, 16 botulinum toxin, and 4 aflatoxin). UNSCOM, UNMOVIC, and the Iraqis themselves regarded these numbers as soft estimates because of the lack of documentation.
- UNMOVIC-monitored excavations at the Al ‘Aziziyah destruction site in February and March 2003 unearthed evidence of 104 R-400s, in addition to the 24 R-400s excavated under UNSCOM supervision. As a result, UNMOVIC considered the 128 R-400s accounted for at Al ‘Aziziyah.

It also appears that Iraq destroyed its stocks of bulk agent in the summer or autumn of 1991, but Iraqi accounts of this destruction vary in timing, amounts, and location. As a result, ISG still does not have a clear picture of bulk agent destruction. There remain a number of inconsistencies in the accounts of the officials involved.

- A 2,200-liter storage tank of anthrax in underground storage at Al Hakam remained there during the 1991 war, along with two one cubic meter tanks on trailers. The trailers had flat tires and the large tank was not transportable. The disposition of this material is unknown, according to a former BW program official.
  - In the summer of 1991, Al Hakam personnel deactivated anthrax stored in an unknown number of one-cubic meter stainless steel tanks using formalin and potassium permanganate. They dumped the anthrax into a septic tank for an unspecified period, then trucked the deactivated anthrax to an area near the production bunkers at Al Hakam and dumped it on the ground.
  - In April 1991, Al Hakam personnel removed some of the *Clostridium botulinum* and *Bacillus anthracis* produced at Al Hakam and stored it in a bungalow in Ar Radwanayah until May 1991, according to Dr. Rihab. This agent was supposed to return to Al Hakam for disposal but was not. Later, Rihab's staff destroyed and disposed of the BW agent in ar-Radwanayah. This concealment and destruction was never declared to the UN.
  - An Iraqi BW program official inadvertently told UN inspectors about the dumping of an unknown number of one-cubic meter stainless steel tanks of anthrax in the desert northwest of Baghdad near An Nibai in July 1991, according to a former BW official.
  - Al Hakam personnel reportedly transported several one cubic meter tanks of botulinum toxin and 340 liters of *Clostridium perfringens* to Airfield 37 in western Iraq in January 1991 as the war was about to begin. At some point, unidentified personnel loaded these tanks onto a truck and drove them around Baghdad until September or October 1991. Iraq had told the UN it destroyed the material in July 1991. This was not so. The tanks probably returned to Al Hakam where, following deactivation, disposal occurred, though the Iraqi NMD could not confirm this, according to a BW program official.
  - One source indicated that the 340 liters of *Clostridium perfringens* at Al Hakam remained there until the destruction of Al Hakam (in 1996), but this contention is not supported by other sources. Another source maintains that researchers tested this agent in May 1991, found severe fungal contamination, and assessed that the agent was no longer pathogenic.
- The Iraqis also apparently destroyed tanks of anthrax at the 'Aziziyah firing range, the site of the R-400 bomb destruction. The number of containers and the amount of agent destroyed is unclear.
- Three one cubic meter tanks of anthrax stored at the 'Aziziyah firing range were ordered destroyed in June 1991, according to a participant in the destruction. After gathering debris from the destruction, he reported to his supervisor, Dr. Bilal, that the tanks had been destroyed. However, an entry in the log book of the officer in charge of the 'Aziziyah range only lists the destruction of two of the tanks, and therefore the source believed that one of the containers still exists at Al 'Aziziyah.
  - Two destroyed one cubic meter bulk storage and transport containers –along with parts of a third container–were found at Al 'Aziziyah during Iraqi excavations of the site just prior to OIF, according Dr. Bilal. If true, it would account for the missing third anthrax tank. Other participants in the 2003 excavations have not confirmed the finding of this third container.
- Iraq declared that all bulk agent, including anthrax that remained after the filling of weapons, had been stored at Al Hakam and was unilaterally destroyed there in July and August 1991, according to UNMOVIC. UNMOVIC also noted that UNSCOM found evidence of anthrax disposal at Al Hakam but considered the evidence insufficient to support Iraq's statements about the quantity of anthrax destroyed and the circumstances surrounding that destruction.
- The problem of accounting for the destruction of bulk agent is part of the larger issue of Iraqi BW agent material balance. ISG cannot arrive at an agent material balance because it still does not know with confidence:

- The amount of each agent produced at each production facility
- The amount of each agent used in weapons filling
- The number of weapons filled with each agent
- The amount of bulk agent of each type destroyed.

It is not clear whether the original decision to eliminate the BW program called for the destruction of bulk agent and BW munitions, or if Iraq initially planned to conceal and retain the bulk agent and filled munitions. Kamil's original plan may have only encompassed the cleanup and conversion of the research and production facilities.

- The BW munitions were all destroyed in the summer of 1991, according to multiple sources, but Iraq was also engaged in a much wider campaign of unilateral destruction during this period that also encompassed the chemical and missile programs.
- Iraq apparently destroyed much of the bulk BW agent in July 1991, but some reportedly remained hidden until September or October 1991, according to one BW program insider.

A letter written by Husam Amin to Qusay Saddam Husayn, as head of the Iraqi SSO, supports the judgment that Iraq unilaterally destroyed most of its pre-1991 CW and BW weapons and long-range missiles. The letter, written in August 1995 shortly after Husayn Kamil fled to Jordan, listed undeclared capabilities that Kamil might reveal to the UN.

- The letter points out that “the destruction of the biological weapons occurred in the summer of 1991 (after the ceasefire) and not in the fall of 1990 as in the Iraqi declaration” to the UN.
- The letter mentions a number of undeclared capabilities e.g. weaponization of BW agents, BW production at the Al Dawrah FMDV Plant, the Badr-2000 program, and other matters, but contains no mention of any existing undeclared CBW weapons or missiles.

Husam Amin acknowledged writing the letter, and ISG judges that the letter is authentic.

### **What Remained Hidden and Undeclared 1995-1998?**

*ISG's investigation found no evidence that Iraq continued to hide BW weapons after the unilateral destruction of 1991 was complete, and ISG judges that most of the documents and materials hidden by the Special Republican Guard from 1991 until 1995 were indeed surrendered to the UN. However, Iraq continued to conceal documents from 1998 until 2003.*

- For several years, Special Republican Guard officers concealed the “know-how” documents, which Husayn Kamil ordered collected in 1991. These officers used safehouses in the Ghaziliyah and Hay at Tashri neighborhoods of Baghdad and a farm in Abu Ghurayb to hide the documents.
- In late 2002, weeks before the arrival of the UNMOVIC inspectors in Iraq, NMD employees reportedly were ordered to collect all documents indicating discrepancies between the number of chemical and biological munitions destroyed or used and the total number produced. These documents, which filled 16 boxes, were being turned in to the IIS to be hidden or disposed of.

ISG investigations also determined that Iraq failed to declare to the UN a number of significant capabilities and activities. Examples of such omissions include:

- Storage and disposal of bulk BW agent, including anthrax, at Ar Radwanayah in 1991.

### **Weaponization Related Activities in the Years Following Desert Storm**

*Various reporting indicates an interest in acquiring systems for the dissemination of CBW.* Acquisition related efforts were usually couched in generic terms, such as “aerosol systems” or “aerosol generators,” and typically associated by the Iraqis with agricultural use. It would also appear that there may have been plans to keep the spray technology remnants of the CBW programs hidden from UN inspectors.

---

**Detailed Accounting of Iraq's Al Husayn Missile  
"Special" Warheads**

According to Iraqi declarations and Dr. Mahmud Farraj Bilal, Iraq had produced 75 "special" Al Husayn warheads, including 50 chemical warheads, and 25 biological warheads.

In April 1991, Iraq initially declared to the UN only 30 warheads—all of them chemical. Iraq destroyed these under UNSCOM supervision. Of the 30 CW warheads:

- 16 contained unitary Sarin (GB) nerve agent
- 14 contained the cyclohexanol/isopropanol mixture that was the basis for Iraq's "binary" GB/GF nerve agent. The methylphosphonic difluoride (DF) component for these warheads was also destroyed.

In addition to these 30 declared chemical warheads, Iraq initially concealed 20 undeclared chemical warheads from UNSCOM, which it destroyed in the summer of 1991. All were "binary" warheads filled with a mixture of cyclohexanol and isopropanol.

After Husayn Kamil fled Iraq in August 1995, Iraq clarified that the 75 Al Husayn warheads actually consisted of 50 chemical and 25 biological warheads. Of the 25 biological warheads, Iraq declared and Dr. Bilal believes that:

- 5 contained "Agent B"—anthrax spores
- 16 contained "Agent A"—botulinum toxin
- 4 contained "Agent C"—aflatoxin

To verify Iraq's claims, UNSCOM sampled remnants of warheads destroyed at An Nibai and found traces of anthrax in containers of seven distinct missile warheads. In response, Iraq changed its account of BW warheads. Dr. Bilal clarified that no one knew for certain the number of warheads filled with a given agent because the Iraqis kept no records of the filling operation.

Of the 45 "special" warheads that were unilaterally destroyed by Iraq, UNSCOM recovered and accounted for remnants of 43-45.

The Al Husayn warhead "material balance" is thus:

75	Total "special" warheads produced by Iraq
30	Destroyed under UNSCOM supervision
20	"Binary" CW warheads unilaterally destroyed at An Nibai
25	Deactivated BW warheads unilaterally destroyed at An Nibai
<hr/>	
45	Total warheads unilaterally destroyed
<hr/>	
75	Total "special" warheads destroyed

- 
- In 1994, a Hughes 500 helicopter was equipped with two L-29 drop tanks at At Taji Airfield by Dr. Imad 'Abd-al-Latif 'Abd-al-Rida' Ali Shihab. He reportedly did this to satisfy a requirement from the Minister of Agriculture to replace its aging agricultural helicopters. No other helicopters were converted. UNSCOM tagged the helicopter and while inspectors agreed it was only for agricultural use, it was kept under close scrutiny. ISG recovered these tanks in February 2004 and have conducted extensive sampling and forensic analysis to determine what materials were disseminated from these tanks,

but have not discovered any materials relating either directly or indirectly to BW.

- The L-39 RPV, UAVs and ballistic missile developments are addressed in the Delivery Systems Section of this Report.

---

**Detailed Accounting of Iraq's R-400 BW Aerial Bombs**

*Iraq declared and Dr. Mahmud Farraj Bilal contends that Iraq originally manufactured 200 R-400 bomb casings for use as BW. Some of these were coated internally with epoxy for filling with "Agent A" (botulinum toxin) and "Agent B" (Bacillus anthracis spores). Dr. Bilal maintains that Iraq unilaterally destroyed 133 or 134 R-400 BW aerial bombs in 1991. In the two months prior to the outbreak of war in 2003, Iraq excavated two R-400 destruction sites in 'Aziziyah and recovered the remnants of 133 or 134 R-400 bombs, including eight or nine intact bombs. UNMOVIC, however, accepted that 128 R-400 were accounted for at 'Aziziyah.*

*Six more bombs were found to be defective prior to filling. Al Hakam personnel discarded these six bombs in the Euphrates River. Later, UNSCOM retrieved these from the river.*

*Dr. Bilal claims that the Iraqis reviewed a videotape of the UNSCOM-supervised destruction of 60 or 61 empty R-400 bombs at Al Muthanna in 1991. They noted that 30 of the bombs destroyed had black-stripe markings, indicating they were epoxy-coated and intended for BW use. Bilal believes that the remainder of the 60-61 bombs destroyed on the tape showed those manufactured for BW use.*

---

*The R-400 BW aerial bomb "material balance" is thus:*

200	<i>casing manufactured for BW use</i>
128-134	<i>Filled R-400s unilaterally destroyed at 'Aziziyah (with 8-9 intact bombs), with UNMOVIC accounting for 128 and Dr. Bilal stating 134.</i>
60 or 61	<i>Empty R-400 casings deestroyed at Al Muthanna under UNSCOM supervision</i>
6	<i>Defetive casings discarded inteh Tigris River by Al Hakam personnel</i>
194-201	<i>Total R-400 casings manufactured for biological use accounted for.</i>

*Dr. Bilal's recent thinking on the R-400 destruction at 'Aziziyah and Al Muthanna is at variance with what Iraq told UNSCOM during the late 1990s. At that time, Iraq asserted that 157 R-400s were destroyed at 'Aziziyah and that 37 were destroyed at Al Muthanna. When these are added to the six disposed of in the Tigris, the number equals the 200 R-400 cases originally manufactured for BW use. Dr. Bilal now contends that Iraq's prior claim of 157 destroyed at 'Aziziyah was based on the diary of an officer at the range and was inaccurate. Bilal's assertion that 60 or 61 empty cases were destroyed at Al Muthanna is at variance with UNSCOM data that indicates that 58 R-400s were destroyed under UNSCOM supervision at Al Muthanna.*

## Unresolved Issues

*In March 2003, when UN inspectors departed Iraq, many contentious issues remained unresolved. Additional issues have emerged from ISG investigations. ISG investigated these matters with interviews, site visits, documents searches and material sampling. ISG made progress understanding most of the unresolved issues, but a few vital areas remain outstanding. With the degradation of the Iraqi infrastructure and dispersal of personnel, it is increasingly unlikely that these questions will be resolved. Of those that remain, the following are of particular concern, as they relate to the possibility of a retained BW capability or the ability to initiate a new one.*

- ISG cannot determine the fate of Iraq's stocks of bulk BW agents remaining after Desert Storm and subsequent unilateral destruction. There is a very limited chance that continuing investigation may provide evidence to resolve this issue.
- The fate of the missing bulk agent storage tanks.
- The fate of a portion of Iraq's BW agent seed-stocks.
- The nature, purpose and who was involved in the secret biological work in the small IIS laboratories discovered by ISG.

Through an investigation of the history of Iraq's bulk BW agent stocks, it has become evident to ISG that officials were involved in concealment and deception activities.

- ISG judges that Iraq failed to comply with UNSCRs up to OIF by failing to disclose accurate production totals for *B. anthracis* and probably other BW agents and for not providing the true details of its alleged 1991 disposal of stocks of bulk BW agent.
- Officials within the BW program knowingly continued this deception right up to OIF and beyond, only revealing some details well after the conflict.
- Those concerned put two motives for the continued denial and deception in relation to undeclared dumping of BW agent at a site in Ar Radwanayah:

—The members of the program were too scared to tell the Regime that they had dumped deactivated anthrax within sight of one of the principal presidential palaces.

—Changing the account would only complicate matters with the UN and would have no effect on the material balance.

More detail on these subjects, where it exists, is included in the appropriate section of the report.

## Program Direction

**Decision Making, Command and Control and rationale of Iraq's BW Program.** Despite access to many of Iraq's senior political and military figures, including Saddam, many aspects of the BW program remain opaque to ISG. Specifically ISG learned very few new details of the following:

- The role of the military and intelligence services in defining the requirements for the BW program.
- The rationale behind key decisions such as the reasons for starting the program, the selection of agents and weapons.
- The military response to meet the requirements of a BW program.
- The doctrine for the use of BW weapons.
- The procedures for the release of BW weapons and who was to make the decisions.

## Research and Development

**Genetic Engineering and Viral Research.** From 1998-2003, Iraq devoted increased resources and effort to its biotechnology and genetic engineering activities, a concern that the UN continued to investigate until its departure. ISG has talked to scientists and workers in the biotechnology and genetic engineering fields, and viral researchers specifically. Despite an extensive interview program and numer-

ous site visits that have included sampling, ISG found no evidence of activity likely to contribute directly to BW.

**BW Agent Simulants.** The UN deemed Iraq's accounting of its production and use of BW agent simulants—specifically *Bacillus subtilis*, *Bacillus licheniformis*, *Bacillus megaterium* and *Bacillus thuringiensis* to be inadequate. ISG remains interested in simulant work because these items may be used not only to simulate the dispersion of BW agents, develop production techniques, and optimize storage conditions, but also the equipment used for their manufacture can also be quickly converted to make BW agent. It permits maintenance of techniques and provides continuing familiarity with the process to preserve skill levels. Iraq continued its work on *Bacillus thuringiensis* as a bio-pesticide carried on bentonite, at Tuwaitha after the destruction of Al Hakam. As a result of interviews with the former staff of Al Hakam and principal researchers at IAEC, ISG has discovered that this research also included investigations of bentonite not only as a carrier but also as means of enabling the speedy production of slurry from the stored dried biopesticide.

### IIS Laboratories

ISG has found a number of small IIS laboratories, some containing biological equipment. There are reports that aflatoxin and ricin work has been conducted by the IIS into the 1990s and that human experimentation occurred. Given the historical connections of the IIS with Iraq's BW program, it is a concern that the nature, purpose and those involved at these small IIS laboratories have not been identified by ISG. This is an unresolved issue that will be further investigated.

### Seedstocks

#### Disposition of Iraq's BW Program Culture Collection

Doubts persist regarding Iraq's destruction of bacterial reference strains and isolates. According to Dr. Rihab, she destroyed these materials in early 1992. Dr. Rihab gave a small box containing no more than 25 vials of lyophilized bacterial pathogens, including those obtained from the American Type Culture Collection to the IIS in mid-1991 for safekeeping.

Husam Amin returned the box to Dr. Rihab in early 1992. Dr. Rihab ostensibly asked former TRC head Ahmad Murtada what to do with the vials. Murtada took the matter to Husayn Kamil, who ordered the vials destroyed. This was accomplished by injecting the vials with Dettol™ and then autoclaving the vials. ISG cannot verify that these materials were destroyed or the other details of Dr. Rihab's account. Given correct storage conditions, ISG assesses that these seed stocks would still be viable.

### Agent Production

**Anthrax.** The UN could not confirm, and in fact its evidence contradicted, the quantities of anthrax declared by Iraq as having been produced, used for trials, filled into weapons, and destroyed. The UN assessed that Iraq probably had greater stocks of the agent on hand in 1991 than it declared, probably for use in the Mirage F1 drop-tanks, and questioned Iraq's account of destruction of the agent. ISG has interviewed most of the key Iraqis who admitted working with the agent, and has obtained contradictory explanations of the events. The details are in Annex A.

**Botulinum Toxin.** Iraq's declaration of the amount of botulinum toxin it produced, used in experiments and trials, filled in weapons, wasted during handling, and unilaterally destroyed is derived from calculations, or contrived from the numbers of weapons stated to have been filled—none of these figures is verifiable. ISG teams have interviewed principal engineers and scientists involved with botulinum toxin; there has been no new information.

**Mycotoxins: Aflatoxin.** The resources that Iraq devoted to the manufacture, testing and filling of weapons with aflatoxin has puzzled investigators since Iraq first declared the agent. There is little doubt that Iraq conducted such a program, but the UN assesses it almost certainly overstated the production, raising the possibility that some of the weapons declared to have contained aflatoxin may have contained other BW agents. There is no evidence to support Iraq's claim about the numbers of weapons filled with the agent, and most of the limited number of staff involved in aspect of the effort have not been located. ISG has not determined the rationale behind Iraq's choice of aflatoxin for its offensive BW program.

**Wheat Cover Smut.** The UN was not able to verify the amount of wheat cover smut produced, used or consumed owing to a lack of sufficient documentation from Iraq. Iraq had stated it produced smut coated with aflatoxin, but neither this statement, nor the destruction of the wheat cover smut could be verified. ISG has not discovered any new information on this agent.

*Clostridium perfringens.* (*C. perfringens*)—the causative agent of gas gangrene—was one of the first agents Iraq examined. Despite its interest and various fragments of research—including interest in cluster munitions and an awareness of the use of *C. perfringens* in anti-personnel weapons—the UN found no evidence to indicate that such a course was pursued. An ISG team obtained two vials of *C. perfringens* as well as one vial of *C. botulinum* type B, from a mid-level scientist who formerly worked in the BW program. This matter is addressed in Section D—R&D.

**Ricin.** Unlike other BW agent programs, work on ricin emanated from the IIS, and almost certainly was based on its limited developed use as an assassination weapon. Iraq conducted a limited weapons development program until Desert Storm that included a test using artillery shells charged with ricin. Later Iraq expanded into the manufacture of castor oil, which yields the material from which ricin is extracted. Although this manufacture was later abandoned, Iraq retained the ability to restart such production in volume. ISG has pursued the Tariq castor oil facility and its possible role in ricin production as well as the security services' interest in and use of ricin.

**Undeclared BW agents**—In addition to the BW agents listed above, Iraq may have investigated variola major (smallpox). Additionally the amount of peptone or tryptone soya broth (TSB) growth media imported by Iraq and not accounted for give rise to concern about the possible production of *Yersinia pestis* (plague), *Francisella tularensis* (tularemia) and *Brucella* species (brucellosis). ISG has examined smallpox and *Brucella*, but has not uncovered any information on plague or tularemia.

## Drying of BW Agents

Iraq actively pursued the goal of drying its BW agent for improved storage and optimal dispersion and inhalation. The UN was unable to determine whether Iraq dried any of the bulk agents it produced, although it possessed the expertise and equipment to do so. ISG has found a successful program for drying the anthrax simulant, Bt; safety of the drying process would affect its application to anthrax. ISG found no evidence of dried agent.

## Bacterial BW Agent Production and Storage

**Production Equipment.** There are a number of critical items of equipment and materials normally required for the production of bacterial BW agents. Iraq was able to manufacture fermentors, separators, settling tanks and growth media, often of a lower quality than those it formerly imported, and all of which have commercial purposes. This manufacturing aspect is a vital prerequisite for resuming a BW program and could lead to the possibility of making mobile BW facilities. ISG investigated the industrial infrastructure needed for such activity and the particular possibility of a mobile BW program. ISG discovered no evidence to indicate a renewed interest in manufacturing equipment for BW purposes.

**1m<sup>3</sup> Stainless Steel Mobile Tanks.** In 1990, Iraq produced 39 1m<sup>3</sup> stainless steel mobile tanks. The tanks are significant because they were used to store and transport bulk agent, and with modification the imported tanks could be used for fermentation purposes to produce BW agent. Al Hakam already possessed eight 800-liter stainless steel mobile fermentors. Iraq claims to have unilaterally destroyed 19 of the 1m<sup>3</sup> and 4 of the 800-liter fermentors in 1991. UNSCOM verified these figures from remnants presented to inspectors in the mid-1990s. ISG has identified the remains of 2 additional 1m<sup>3</sup> tanks. Thus out of an original 47 items, 18 1m<sup>3</sup> and four 800-liter fermentors are still to be found. There are 22 items unaccounted for. Additionally, ISG has learned of additional production after 1990 (see Figure 13).





**Figure 13.** 1m<sup>3</sup> Stainless steel mobile tanks.

### Weaponization

**Al Husayn Biological Warheads.** Iraq declared that it manufactured a total of 25 Al Husayn warheads for BW, claiming to have filled 16 with botulinum toxin, 5 with *Bacillus anthracis* spores, and 4 with aflatoxin. There is evidence only to confirm that sufficient stainless-steel agent containers were unilaterally destroyed to account for the declared quantities of BW warheads. It is not possible to conclude that all of the BW warheads were destroyed or that only three agents were used.

**R-400 and R-400A Bombs**—Iraq declared that it ordered the manufacture of 200 R-400A bombs for BW, but reportedly did not fulfil that quota and instead used some R-400 bombs. Iraq claimed that 157 bombs were filled with BW; 100 with botulinum toxin, 50 with *Bacillus anthracis* spores, and 7 with aflatoxin. Investigations by ISG at the Al ‘Aziziyah site confirmed that by the beginning of OIF approximately 132 out of 157 bombs had been accounted for, indicating that at least 25 bombs remain unaccounted for. Because all the known physical evidence has now been investigated, it is unlikely that this matter can be resolved without the discovery of documents or new testimony from those involved.

**Spray devices and RPVs.** Iraq showed a continuing interest in the use of spray devices as a means of dispersing BW agent. The program started with the adaptation of helicopter-borne agricultural spray equipment and progressed through experiments with MiG-21 and Mirage F1 aircraft. In the 1990s L-29 aircraft were adapted for remote operation, but there is no evidence of spray tanks being fitted to them. The Mirage F1 used an auxiliary fuel tank as a trial spray system. Iraq claims that only 4 of these tanks were modified and that the original tank and aircraft were destroyed in opening bombardment of the Gulf war in 1991. No evidence exists to support the destruction of the aircraft and tank, although the remains of the other tanks have been verified in the past. Recent ISG investigations have discovered very large numbers of drop tanks, but none that had been modified for trials or use as a BW weapon. The L-29 development program continued up to OIF and Iraq possessed approximately 30 L-29 aircraft that could be adapted for remote operation. Drop tanks existed for this aircraft, some in use at the same site that had been used for helicopter spray trials.

*This page intentionally left blank.*

## Annex A Bulk BW Agents

### Background

Under UNSCR 687 Iraq was required to disclose all aspects of its weapons of mass destruction (WMD) program. However, four years passed before Iraq admitted it had an offensive BW program. *Even after this, despite warnings about the consequences of not disclosing everything completely and truthfully from the UN, Iraq chose defiance. Iraq never disclosed the true amount of B. anthracis and probably other BW agents it had produced before 1992 as well as several locations where bulk BW agent was stored, and in one case, destroyed, according to multiple sources.* UN inspectors on many occasions asked members of Iraq's BW program about additional storage sites, suggesting that they suspected, or knew of such a site or sites, but Iraqi officials persisted with their deceit until OIF and beyond.

### ISG Investigation

#### Disparities in Declarations Concerning Pre-1992 *B. anthracis* Production

Information obtained by ISG from several sources with access to Iraq's former BW program and other related historical information show that Saddam's Regime probably did not declare the production of thousands of liters of *B. anthracis*. This information appears to support pre-OIF judgments made by the Intelligence Community and UN inspectors that Iraq did not disclose the total amount of BW agent it had produced, and therefore continued to be in violation of UNSC resolutions. Although ISG assesses there to be only a very small chance that Iraq kept some of this undeclared *B. anthracis* until OIF, ISG has been unable to obtain evidence to substantiate preservation or complete destruction of the agent.

- Iraq produced much more *B. anthracis* between 1989 and early 1991 than it declared to the UN, according to an individual that worked in Iraq's former BW program. This individual told ISG that approximately 550 kilograms (kg) of the peptone growth media Iraq declared as "lost" actually was used to produce the *B. anthracis* that was not declared. Enriched mediums, such as peptone were used by Iraq to produce seed *B. anthracis* for the bulk production process.
- BW agent production continued at Al Hakam until the day before the start of the first Gulf war in January 1991—contrary to Iraqi declarations, which stated that production ceased at the end of 1990—and the FMDV Plant was used to produce *B. anthracis*, according to an Iraqi formerly involved in biological agent research.
- UNSCOM found *B. anthracis* in two fermentors and a mobile storage tank at the FMDV Plant that was "consistent with the strain used in Iraq's BW program," according to an UNMOVIC document on Iraq's unresolved disarmament issues (UDIs) as of 6 March 2003. Two pieces of the equipment that tested positive were destroyed by UNSCOM in 1996, and subsequent sampling of the FMDV Plant in November 1996 did not detect *B. anthracis* on any remaining equipment.
- Iraq's Military Industrialization Commission (MIC) sequestered a portion of the production facility at the FMDV Plant from July 1990 until July 1991 for secretive work that emitted a smell of peptone two to three times a week, according to a current assistant manager of the FMDV Plant who has worked there since the early 1980s. ISG judges some of this secretive MIC work was the botulinum toxin production Iraq declared it produced at the FMDV Plant in November and December 1990; however, the continuous peptone smell outside of these dates fits with information from the individual that worked in Iraq's former BW program, who told us that the peptone declared as "lost" was actually used to produce more *B. anthracis* than was declared at both the FMDV and Al Hakam.
- UNSCOM and UNMOVIC could not verify the amount of BW agent Iraq declared producing because of discrepancies in its reporting of the amount of media and fermentor time available to produce the agent, according to the UNMOVIC document on Iraq's UDIs.

- Despite repeated attempts by ISG to confirm this information with interviews with key personalities who would be knowledgeable, no further information or physical evidence has been collected up to this point.

This deception, in effect, prevented any possibility of the UN accepting the Iraqi account of its BW program. Whether those involved understood the significance and disastrous consequences of their actions is unclear. These efforts demonstrate the problems that existed on both sides in establishing the truth.

### **Undeclared Movement and Destruction of Bulk BW Agent**

ISG has conducted a series of interviews and site visits to uncover more information on the movement and destruction of at least some bulk BW agent in 1991. When Iraq disclosed its offensive BW program in 1995, those involved decided not to disclose the movements and destruction areas associated with bulk BW agents.

- A scientist who worked for the former Iraqi Regime told ISG that Iraq destroyed three tons of *B. anthracis* at Al 'Aziziyah. ISG assesses that this three tons of *B. anthracis* only is a portion of that not declared to the UN.
- An assistant of Dr. Rihab told UN inspectors in early 1997 that he had taken an unspecified number of one-cubic meter tanks filled with *B. anthracis* into the desert north of Baghdad near An Nibai and dumped the agent there in July 1991, according to the Iraqi formerly involved in biological agent research.
- The chief reason offered for not declaring agent disposal at Ar Radwanayah was fear of informing Regime officials that Dr. Rihab's BW staff had deposited deactivated *B. anthracis* and probably at least one other agent in an area surrounded by Special Republican Guard (SRG) barracks and within site of the Ar Radwanayah Presidential Palace.
- How high up the chain of command this knowledge of undeclared movement and destruction went is yet to be determined. Evidence suggests that the Head of the Technical Research Center (TRC), Ahmad Murtada, the official responsible to Husayn Kamil for BW, knew, but he denies it. It has yet to be determined if 'Amir Al Sa'adi, Husam Amin, or the Vice President and the Higher Committee also knew.

## **Annex B BW Research and Development Facilities**

Iraq's BW program was initiated in early 1974 in a house in Al 'Amiriyah, but soon after completion of basic buildings on a new site, Al Hasan's Ibn-Sina Center, or site number 2 (or later Al Salman) the program was transferred to Ibn-Sina Center mid 1974. This site was heavily bombed in 1991 and was effectively not functional after that time. After the initial construction of a clinic, telephone exchange in mid-peninsula, a bacteriology laboratory building which appeared to have functional high containment capability. On the back of this building was an attached animal house. Next in line was a virus laboratory, compartmented into 6 laboratories. This represented "Phase 1." Even before the transfer of the new BW program from Al 'Amiriyah, plans were already established for another facility (the green cube) "Phase 2" which became available about the same time as the dissolution of the original Al Hasan Institute. The remaining biology program along with elements of the CW program was then emplaced in this building as was the newly created Research and Technical Center (later to become the TRC). In the early 1980s Phase 3 was completed in the form of the Toxicology Laboratory to which the militarily relevant program was transferred in 1987.

Revitalization of Iraq's militarily relevant BW program was located at Al Muthanna from 1983 to 1987 when it was relocated to Al Salman. However, Al Muthanna continued to provide significant R&D assistance through 1990 particularly studies on aflatoxin and ricin as well as weapons field trials.

For many years, both before and following Desert Storm, the IIS conducted research and development of biological agents, such as ricin and aflatoxin, at several facilities discovered by ISG. Brief descriptions of these laboratories are presented below. The Al Safa'ah (AGRC), Al Salman and Al Muthanna sites were no longer functional after 1991 and thus further descriptions are not provided. Al Hakam, Al Manal, TABRC, Al Hamath, and the Al Tariq Company are deemed to have a significant post 1991 BW related capability and the descriptions follow. Baghdad University,

College of Veterinary Medicine, al Razi Research Institute, al Kindi Veterinary Vaccines and Drug Company, Al 'Amiriyah Serum and Vaccine Institute have the facilities and expertise to play an important role in a resurgent R and D program.

### **Al Hakam**

*The Al Hakam facility was destroyed by the Iraqis under UNSCOM supervision in 1996 because of the discovery of the key role it played in the Iraqi BW program.* Historically, Al Hakam was Iraq's primary BW agent production facility, producing *Bacillus anthracis*, *Clostridium botulinum*, *Clostridium perfringens* and simulant, *Bacillus subtilis*, for testing and ultimately, weaponization purposes. Following the first Gulf war, the Al Hakam plant was directed by Iraq to change its focus to civilian projects, which had been selected as a cover for its former BW program.

- The civil projects chosen to replace the production of BW agents and using the same equipment at Al Hakam were the production of biopesticides (*B. thuringiensis*), SCP and biofertilizers. The equipment at the facility was considered dual-use and the production of materials such as *B. thuringiensis* (a known stimulant for the BW agent *B. anthracis*) and SCP (whose equipment could be used to produce *C. botulinum*), led to the fear that Al Hakam could potentially be producing BW agent or at the very least, be maintaining the infrastructure and production expertise necessary to quickly reactivate Iraq's BW agent production capability.

### **Al Dawrah Foot and Mouth Disease Vaccine Plant**

*The FMDV plant was declared to UNSCOM as a facility that was used to produce botulinum toxin for offensive BW purposes from September 1990 until January 1991. After Iraq acknowledged its role in its BW program, UNSCOM disabled the FMDV plant's high containment air handling system in 1996 by pouring a mixture of concrete and foam into its ducting. No laboratory or production work is currently conducted at the FMDV plant.* The plant is

currently being used as a central storage and distribution depot by the State Company for Veterinary Medicine. ISG has no information to suggest that the FMDV facility was involved in any BW-related research after the end of the first Gulf war in January 1991.

- Freezers were discovered by ISG containing hundreds of perished isolates of foot and mouth virus. The facility was also storing laboratory equipment from other facilities and archives from other veterinary institutes. No research or scientific activity was occurring at the facility.
- According to a source, the FMDV plant only produced vaccine up until 1990/91. The Main vaccine it produced was for Foot and Mouth Disease (FMD) Type 0 (for sheep). It also produced types A20 and Asia (for cows). The plant exported its FMD vaccine to 13 other countries in the region. From 1990-1991, MIC took over the FMDV plant. While the MIC was operating the facility, they gave the FMDV employees a small area in which to conduct work that was separate from MIC activities. None of the workers from the FMDV plant were said to have been brought in to help MIC. However, this is contrary to what was communicated to UNSCOM.
- Surveillance cameras were installed at the facility by UNSCOM in 1994/5 to monitor the activities at the facility until and following the removal and destruction of some key equipment. Cameras were also mounted in the plant's production department. Until some time prior to OIF, tapes were retrieved every two weeks by a local security company on behalf of the UN. The purpose of the cameras, after the building was rendered harmless in 1996, was to assure the equipment was not removed and installed at another location without proper notification to the UN.

### **Tuwaitha Agricultural and Biological Research Center**

*ISG investigated work into Bacillus thuringiensis and Single Cell Protein carried out at the TABRC. ISG exploited TABRC in 2003. During the exploita-*

*tion, significant documentary evidence of ongoing research relative to Bt at TABRC and a number of equipment items which were capable of being used for production of small-to-pilot scale quantities of biological material.* Numerous fermentors and bioreactors were found, some of which should have been reported to UNSCOM or UNMOVIC but were not. The underground storage of laboratory equipment was likely to protect that equipment from coalition bombing.

- TABRC was part of the IAEC within the Tuwaitha Nuclear Research Complex. Its mission was primarily agricultural science research and development, and the majority of its activities was directed toward crop improvement and integrated pest management. This facility possessed a mature scientific staff with expertise in recombinant DNA technology, microbiology, entomology, and access to agricultural pathogens. The center had research and development arrangements with other Iraqi biotechnology entities and possessed numerous pieces of equipment that could be used for either peaceful purposes or for development and production of BW agents (i.e., dual-use equipment). The facility was located within a high-security complex associated with other facilities of interest.
- *ISG assesses that TABRC was not involved in any significant BW-specific activity. Work with Bt appears to have been laboratory scale only and primarily directed toward expanding the insect host range of Bt isolates.* There was no evidence to support earlier ISG contentions that attempts were underway at TABRC to engineer *B. thuringiensis* to be pathogenic for humans.
- ISG conducted detailed site exploitations of TABRC over a period of several days. The determination was made that the site contained numerous pieces of UNSCOM-tagged equipment, as well as multiple pieces of undeclared equipment, that would be useful for BW agent production. The equipment ranged from a declared 750-liter double-jacketed stainless steel fermentor to an undeclared 5-liter fermentor. ISG found no information indicating any of this equipment was either intended or used for BW purposes.

## Al Hamath

*The Al Hamath facility was exploited on 19 April 03, which determined that the area was used for agricultural purposes and the activities assessed to have occurred at the site were determined not to be BW-related. The facility was heavily looted before it was exploited in April 2003. A local national at the site reported that the facility had been under military control and prior to UNMOVIC inspections the military had removed all the equipment from the site. Field laboratory analysis of samples taken from the barren facility also indicated no evidence of CW or BW related materials in the submitted samples.*

In 2000, TABRC began the construction of a pilot Single Cell Protein (SCP) plant at Al Hamath, located at the same site as the Official Rest House, to conduct larger scale SCP work. The project for the pilot plant scale production of citric acid had been started using *Aspergillus niger* but the project could not be made to work.

- The production method chosen was growth in submerged culture rather than in solid-state. Process equipment (e.g. mixing vessels, tanks, fermentation vessels) was commissioned and fabricated accordingly. The strain of *A. niger* used in this process proved unsuitable for use in submerged culture as the mycelium suffered damage under the continual stirring/agitation necessary in submerged culture. In short, the project could not be made to work. Having a collection of process equipment already in place at Al Hamath, it was seen as convenient to co-opt and reconfigure the equipment for SCP production.
- A source indicated that the SCP process was set up in the northeastern corner of the larger of the two main buildings at Al Hamath. The remainder of the space in the larger hall was devoted to the production of fungal biopesticides (e.g. *Paecilomyces*, *Trichoderma*) grown in solid-state culture on milled corncobs. The fermentations were conducted in the rooms (offices) pre-existing in that building.

## Al Tariq Company's Habbaniyah I/Fallujah III Site

The Al Tariq Company produced castor oil by extraction from 1992 until 2002, using an Iraqi-designed and produced crushing mill purchased locally. Al Tariq officials complied with UNSCOM on the requirement that they burn the bean mash left over from production while UN inspectors remained in Iraq. This open pit burning of mash was no longer observed after the plant was reconstructed, post-Operation Desert Fox bombing, and went operational. The mash, which took days to burn and created significant smoke, was burned in pits near the Fallujah III facility. At one point, Al Tariq officials considered using the bean mash in animal feed, but this idea was never implemented.

- Farmers at Al 'Aziziyah claim their land was taken by Husayn Kamil in 1994 or 1995 to be utilized as dedicated lands for the growth of castor plants, the end user of which was exclusively the Al Tariq facility. The MIC reportedly worked in collaboration with both the State Company for Industrial Crops and the Ministry of Agriculture to plant "cover crops" –other crops such as wheat in order to mask the growth of the castor plants. In 2001, an employee of the Al Tariq Facility named "Husayn" told an individual at the farm that the castor beans were being used by the Al Tariq Facility in order to "produce poisons that would kill humans."
- Historically this site has been of concern because the castor oil plant could have potentially been used in the first step, mainly the castor bean mash, in the production of the BW agent Ricin. Iraq stated several different ways in which the ricin in the mash was being inactivated; yet UNSCOM showed that active ricin could readily be isolated from the mash after the castor oil was removed.
- During this time period, officials from Ibn-al-Baytar expressed an interest in purchasing castor oil from Al Tariq for use in pharmaceuticals. The Al Tariq facility's oil was not competitively priced, however, and because it was extracted by solvents instead of cold pressing, Al Tariq's oil was not considered to be "food grade", or appropriate for

medical/pharmaceutical uses. At one point, SDI purchased five tons of Al Tariq oil for pharmaceutical purposes, but upon sampling the oil, immediately deemed it as inappropriate for medical use and sent all of the castor oil back to Al Tariq. Because of these issues, Ibn-al-Baytar decided to procure castor beans directly from the same source as Al Tariq, the Company for Industrial Forests (CIF). After production ended in 2002, Al Tariq was left with unwanted castor oil, but no customers. The leftover castor oil was kept in barrels at Fallujah III.

*During the work of the UN and ISG, a number of facilities have been identified as having carried out or have been assessed as capable of carrying out R&D on viruses. These facilities include the Al Kindi Company for Veterinary Vaccines and Drugs, the Al 'Amiriyah Serum and Vaccine Institute, the Al Razi Research Center, the Al Dawrah Foot and Mouth Disease Vaccine plant (before 1996 when UNSCOM disabled the air handling system), Baghdad University College of Veterinary Medicine at Abu Ghurayb and Al Hakam before its destruction (also in 1996). Al Hakam and Al Dawrah FMDV facilities are described above.*

#### **Al Razi Center**

*ISG determined that the Al Razi Center is no longer suitable for research or production of any biological activity because of extensive looting.* ISG has no information to suggest that Al Razi was actively involved in R&D of viral BW agents for the Iraqi BW program. An ISG visit to Al Razi found numerous vials of lyophilized bacteria and yeasts that were littering the site including: *Vibrio cholerae*, *Salmonella typhi*, *Salmonella paratyphi*, *Clostridium difficile*, *Clostridium welchii*, *Saccharomyces cerevisiae*, *Brucella melitensis*, and *Brucella abortus*. In addition, numerous vials of lyophilized avian influenza were also noted.

Several burn piles consisting of burned documents, vials, chemicals, electronic media and small pieces of equipment were located around the building. The piles seemed to be an organized destruction effort given stir rods located with some of the piles.

An inventory of UNSCOM tagged equipment was conducted. Four pieces of dual-use laboratory equipment were noted missing.

ISG assesses that the research expertise available at the Al Razi center could potentially have been used to research viral BW agents.

- Al Razi was established in 1992 under the direction of Saddam Husayn. Dr. Hazim 'Ali, a senior personality related to the Iraqi viral BW program, and Athir Al Duri were responsible for setting up the facility with Dr. Hazim 'Ali in charge of the virology department and Al Duri director of the bacteriology department.
- The virology department at Al Razi was involved in work on Hepatitis and mumps diagnostic kits, using positive sera obtained from the Ministry of Health. The facility also had an animal house where they kept sheep, goats, rabbits and mice. No primates were seen by the source but monkey cages were seen in 1996 after a delivery from Al Muthanna.

#### **Baghdad University, College of Veterinary Medicine, Abu Ghurayb**

*ISG found no information to suggest that the College of Veterinary Medicine, Baghdad University, played a role in the R&D phase of the viral BW program.* ISG has uncovered no substantial connection between the BW program and the College of Veterinary Medicine.

- The College of Veterinary Medicine was capable of viral research. The faculty at the College of Veterinary Medicine possess the requisite knowledge and skill to grow and genetically manipulate potential BW agents. Based on the faculty's description of the equipment that was looted, the College had adequate resources to grow agents such as high-risk virus. However, the remaining equipment found in 2003 by the assessment team at the facility is inadequate to conduct any significant research or production of BW agents.



## Al Kindi Company for Veterinary Vaccines and Drugs

*All known UNSCOM tagged equipment at the Al Kindi Company for Veterinary Vaccines and Drugs was present at the site. The site is operating normally, although at a reduced level.* A senior employee explained that they were still in the process of trying to reinstate the quality of their vaccines and had not yet developed elaborate plans for the future.

- Prior to Desert Storm, the facility was believed to be involved in Iraq's BW program. A foreign company supplied a complete vaccine production line in 1984 for the facility to produce "Co-Baghdad vaccine," a mixture of veterinary important Clostridial species. It was most of this vaccine line that was acquired by Al Hakam and used at that facility prior to 1991. Presently the company is able to produce viral disease vaccines for poultry to include: Newcastle, fowl pox, and gumboro; and viral vaccines for livestock to include rinderpest, sheep pox and goat pox. Bacterial disease vaccines include: enterotoxaemia (sheep), hemorrhagic septicemia, blackleg (*C. perfringens*, cattle), anthrax (sheep). Al Kindi Company did not sustain any damage during OIF, and no looting had taken place, since the employees stayed in the buildings and guarded them. No seed cultures were lost, since the company has generators that supplied power to the refrigerators and freezers without interruption.
- In April 1994, an UNSCOM Team found that the facility was the sole Iraqi producer of veterinary vaccines required to protect against animal viral, bacterial, and parasitic agents (including anthrax). However, a 1997 UNSCOM report indicated Al Kindi personnel had the expertise to run a BW production facility as well as apparent access to military significant microorganisms, and would have been able to easily convert veterinary vaccine production to production of human vaccines.

The Newcastle vaccine product lines at Al Kindi demonstrate an ability to scale up large quantity viral production. Al Kindi Company had the facilities that would enable mass production of smallpox virus in either cell culture or fertilized eggs, and in either liquid slurry or lyophilized form, however, no indication of intent to do so was found by ISG.

## Role of Al 'Amiriyah Serum and Vaccine Institute (ASVI) in Smallpox R&D

*ISG has uncovered no evidence to support smallpox R&D at ASVI for possible use as an offensive BW agent.* The ASVI is the only facility in Iraq acknowledged to be associated with smallpox, albeit with the smallpox vaccine. The Institute continued to manufacture a smallpox vaccine through to the early 1980s.

*ISG discovered no indications of BW activity at the facility.* All equipment and material observed appeared related to serum and vaccine storage, quality control and very limited organic production capability. An ISG assessment on the facility states that it is unlikely that ASVI was involved in suspicious BW-related activities other than possible temperature control storage. Laboratory results from samples taken from the site were negative for BW agent signatures.

- ASVI produced limited quantities of bacterial and viral vaccines and diagnostic reagents and kits for human use. According to Hazim 'Ali, head of the Iraqi viral BW program, any smallpox isolates would have been stored at either the ASVI or the Central Public Health Laboratory. The director of ASVI stated, in a recent interview, that ASVI produced three and half million doses of smallpox vaccine in 1980, a month after the start of the Iran-Iraq war, eight years after the last smallpox case in Iraq and the year it was declared eradicated in the world. The director stated that vaccine might have been for defense against an Iranian BW attack, but it is also possible that the vaccine could have been a defensive measure for anticipated Iraqi smallpox use against Iran.
- From its inception, ASVI has not had the biosafety equipment, procedures or technical expertise to work with dangerous pathogens. Economic sanctions and import restrictions further impeded their ability to perform even basic research. In March 2003, the facility was extensively looted with reconstruction efforts at the facility focus on replacing air conditioning units, doors, windows and providing a consistent source of electricity. As of late August 2004, through its affiliation with a humanitarian organization, Kimadia State company for Marketing and Medical appliances, and the Iraqi

- Ministry of Health, the facility was able to import small amounts of vaccine and other reagents. These were to be stored and later distributed by the facility.
- From 1975 to 1982, ASVI produced smallpox vaccine, utilizing the vaccinia strain; samples of the vaccine were cultured and collected from bovine calf skin. Production of smallpox vaccine was conducted under the auspices of the World Health Organization (WHO) from 1975 to 1977. The WHO vaccine was produced and stored in liquid form but between 1977 and 1980, ASVI also produced a powdered/lyophilized vaccinia product. In October 1980, ASVI requested Vaccinia seed stock from the WHO to produce more vaccine. The request was denied due to the disease having been eradicated, and the WHO ordered ASVI not to proceed with its vaccinia work but the Iraq Ministry of Health ordered it to produce the vaccine. By 1982, the viral research branch responsible for the smallpox vaccine, produced and subsequently stored, 3.5 million doses of the vaccine in liquid form. These samples were assessed to have a shelf life of three years. The remaining 750 grams of bulk smallpox vaccine preparation was stored in a powdered/lyophilized form. This preparation had a shelf life of 10 years.
  - The vaccine produced as by ASVI in response to the request from the Iraqi Ministry of Health was manufactured by strengthening some vaccine it had previously produced and stored. The strain identified as having been used was Lister. The material was strengthened by three times inoculating rabbit skin and then infecting calf bellies. Each calf belly yielded about 200,000 doses of the vaccine. The scientist responsible for conducting the work left ASVI in 1982 and there were no tests of vaccine efficacy, such as neutralizing antibodies, in humans in Iraq. The 750 grams of material were tested in 1986 and found to be nonviable. In 1992, the 3.5 million doses of vaccine were tested and determined to be nonviable also. It was recommended that the vaccine be destroyed but ISG has been unable to confirm or deny this claim.
  - In 1994, Iraq completed a WHO questionnaire regarding the reporting of smallpox vaccine production activities, vaccine stocks and seed virus strains. Their response indicated that ASVI maintained two smallpox vaccine seed vials that Iraq had obtained from the Netherlands before 1977 and 19 vials of *Brucella* antisera that had been produced in rabbits and mislabeled as vaccinia. In addition, a 1994 inventory submitted to the NMD listed the facility as possessing two vials of “smallpox seed No. Q1”. During meetings with UNMOVIC in December 2002 regarding the 19 antisera vials and the two seed stock vials, Antoine Al Bana took one of the 19 vials for analysis and an UNMOVIC inspector also took one. Al Bana determined that there was nothing viable in the vial that he analyzed.
  - Two vials of smallpox vaccine seed stock labeled “Rijks Instituut V.D. Volksgezondheid—10 ml seedvirus—L1 K2—Strain Elstree—Utrecht” were discovered at ASVI. These two large vials may be the seed vials referred to in the 1994 report to the NMD, however, SMEs note that the vials were markedly different in content and appearance. No locally produced vials labeled “Elstree” were discovered at ASVI. ISG is awaiting confirmation on the contents of these vials.
  - According to a DGS intelligence officer who provided security at Rihab’s laboratory at Al Salman and Al Hakam, an individual connected with ASVI in 1989 to 1990 had IIS connections and supported Rihab’s BW efforts at Al Hakam. The individual had frequent contact with Dr. Rihab beginning in 1990. Rihab made frequent visits to Al ‘Amiriyah Sera Vaccine Institute where she and the individual conducted unidentified BW related research. At ASVI, the individual source had access to special laboratories and conducted unspecified genetic research. The DGS officer stated that the source helped Rihab in her work. The DGS intelligence officer also stated that the source was an IIS officer and that his work was related to the IIS. When asked how he knew this he stated that Rihab was under constant surveillance by the IIS and that he learned the source’s affiliation from other IIS officers. The individual left ASVI in 1991 to work at Baghdad University.

- All buildings, which were found to be heavily looted during April and May 2003, are now generally restored with equipment replenishment in progress. The UN tagged and untagged dual-use equipment found and the site were consistent with the declared purpose of the site.

### **State Company for Drug Industries and Medical Appliances**

*ISG exploitation of Samarra Drug Industries' (SDI) location revealed industrial scale utilities and numerous, dual-use jacketed vessels, some of which had not been declared to the UN. ISG found no evidence that equipment at Samarra had been modified to serve as fermentors for BW production. ISG assesses, however, that the staff possessed the required expertise for bulk BW agent production and that Samarra potentially would have been capable of limited breakout production of BW agent within one month prior to OIF.*

SDI belongs to the State Company for Drug Industries and Medical Appliances, which, in turn, is part of the Ministry of Industry and Materials (MIM) and under its direction and control. The main activities of the site are R&D and production and formulation of pharmaceutical products. A technical group within MIM provides guidance and direction for pharmaceutical compounds to be researched at SDI. Staff protected the plant post OIF and hence minimal looting took place.

- The facility appears to be producing its full product line except for antibiotics.
- Site buildings contain numerous jacketed process tanks ranging in capacity from 100–10,000 liters together with ancillary equipment such as filter presses, autoclaves and bio-safety cabinets. (Figures 4, 5, and 6)
- All equipment was assessed to be in good working condition.
- ISG judges that the 10,000-liter industrial scale tanks at Samarra are compatible with their declared

use--the manufacture of pharmaceuticals—and that they would require considerable modification to function as fermentors for BW production. However, ISG also judges the 3,000-liter and possibly some or all of the 1,000-liter stirred, jacketed vessels could be pressed into service for BW production within one month.

- An ISG team was reluctantly admitted to a production hall containing tiers of linked, jacketed, stainless steel vessels, of Soviet origin, which were piped to receive steam. Some of these vessels were fitted with aeration rings and glass viewing ports but no stirrers/agitators were evident. (Figure 7) None of these vessels had been declared to the UN.
- The plant general manager asserted that these vessels were for solvent extraction of natural oils from plants, and that they were last used in 1975-76. ISG judges the vessels have a potential dual-use capability and that they could be adapted to function as fermentors for production of BW agents.
- High quality industrial scale steam and water utilities were available on site. (Figure 8)

### **Laboratories of the Iraqi Intelligence Service**

ISG interviewed several sources and identified several suspect clandestine laboratories that reportedly supported biologically related research. ISG has not been able to determine whether these laboratories were part of a clandestine BW effort.

The tactic of using IIS and covert laboratories has historical precedence dating back to the programs origins in the 1970s. Reverting to this practice would minimize the evidence available to inspectors. It would also leave the known and acknowledged BW workers free to deal with the UN inspection regime. However, it would require another cadre of scientists other than ones known to the UN to conduct this kind of research. The discovery of multiple clandestine laboratories after OIF lends some credence to this assessment.

ISG found a possible DGS laboratory in Baghdad that contained a variety of chemicals but no laboratory equipment. Residents in the building alleged that the laboratory was a biological one. The investigating team found several DGS administrative documents, some of which were from employees requesting approval for danger pay for their hazardous work with biological and radioactive materials. This warehouse complex, adjacent to the 5-story IIS laboratory (site 5), was reported by a former mid-level IIS chemist to be a storage facility for IIS chemicals and equipment. A separate former IIS officer indicated this was a former IIS training facility and hide site; materials were reportedly moved from the IIS safe house (site 2) to this warehouse in the beginning of 2003 to avoid discovery by UN inspectors.

- During the first exploitation in April 2003, the exploitation team found large quantities of liquid and dry chemicals, equipment, documents, and other materials—some of which were partially destroyed. A visit to the site in July revealed a completely looted warehouse complex with no remaining evidence of chemicals, equipment, or documentation. A former IIS officer indicated that other IIS officers returned to the site in late April to destroy the remaining materials.
- Though not BW, ISG learned that the Chemical Preparation Division of IIS's M16 Directorate of Criminology used this approach for lethal chemical research. The IIS used a succession of four clandestine laboratories in At Taji and Baghdad between 1996 and 2003 to research and develop chemicals. It also included testing of chemicals on small animals like mice, rabbits and rats.
- There is information that suggests that up to 5 IIS laboratories operated in the greater Baghdad area at various times up until OIF.
- Additional reporting, though unconfirmed, indicates that the M16 Division also conducted BW related research in two covert laboratories as well. In the early 1990s, Saddam tasked the IIS to do small-scale BW work in covert laboratories concealed within legitimate facilities. Further unconfirmed reports indicated the IIS conducted BW and CW experiments and stored WMD precursor materials in residences and warehouse around Baghdad through April 2003.

- Information collected at the time of OIF led to the discovery of assorted laboratory equipment purportedly used by a suspect BW scientist on the Black List at a Mosque in Baghdad.

An ISG team at the Baghdad Central Public Health laboratory identified a clandestine laboratory in the summer of 2003. According to an employee of the laboratory, the IIS operated a laboratory at that location for several years. In advance of a 1998 UNSCOM inspection, secret documents were removed and stored at the Director's house. In December of 2002, the laboratory was emptied of all equipment and documents.



**Figure 4.** Two 1,000-liter, stirred, jacketed vessels suitable for use as fermentors for the growth of bacterial BW agents.



**Figure 6.** Autoclave with control panel.



**Figure 5.** Plate filter press.



**Figure 7.** Production hall with tiered vessels of Soviet origin not declared to the UN.



**Figure 8.** High grade water production plant.

*This page intentionally left blank.*

## **Annex C ISG Investigation of Iraq's Reported Mobile Biological Warfare Agent Production Capability**

### **Summary of Pre-OIF Intelligence on Iraq's Mobile BW Program**

According to a chemical engineer whose reliability ISG now believes is highly questionable, Iraq developed a mobile BW capability designed to evade UN inspections and to provide Baghdad the ability to produce biological agents for offensive purposes. The chemical engineer stated that seven production units had been built, three of which had begun agent production runs. He identified six locations of the seven plants, as well as key engineers and personnel involved in the design, construction, and operation of the units (see Figure 1). Additional sources reported before OIF on the existence of a mobile biological capability in Iraq:

- An Iraqi civil engineer in a position to know the details of the program reported the existence of transportable facilities moving on trailers.
- An additional source reported that Iraq had manufactured mobile production systems mounted on road-trailer units and on rail cars.

### **Objectives of Investigation**

Because Iraq's reported mobile BW agent production capability was a key element of the prewar assessment of Iraq's WMD programs, it was an important issue addressed by ISG, and the BW team tasked a variety of collectors and analysts against this intelligence issue with the intent to do the following:

- Locate and debrief Iraqis identified as being directly involved in the planning, design, manufacture, and operation of the BW agent production plants.

- Exploit the sites named as having an involvement in the program, as well as ancillary sites and companies connected to the cover story.

*In the wake of ISG's investigation, ISG is unable to confirm the existence of a mobile BW agent production capability in Iraq. Key personnel in the mobile program were said to have been involved in both BW activities at Al Hakam and the design and construction of legitimate seed purification plants. Key findings include:*

- All individuals that ISG questioned denied the existence of a mobile BW agent production capability.
- Individuals linked to sites that were part of the investigation deny that the sites were used by the military or intelligence services, or used to conceal specialized equipment, trucks, or railcars.
- Two key sites that reportedly housed production units bear physical features that ISG assesses prohibit their use in the manner described by the source.
- ISG has not been able to determine the involvement of other sites reported by the chemical engineer to have been linked to the mobile program largely due to post-OIF events at the sites, such as turnover of personnel and looting.
- While ISG established that the chemical engineer had access to both Iraq's seed purification project and BW program, there are concerns regarding his employment and whereabouts after 1995, which is the period that he claimed to have been involved in the mobile BW program.

### **Origins of Iraq's Mobile BW Program**

Many of the key personnel that ISG investigated were employed at the Chemical Engineering and Design Center (CEDC), which later became part of the Sa'ad Center. By the very nature of their employment, these individuals were involved in both the design and construction of the single cell protein lines at Al



Figure 1. Reported production sites.

Hakam—which could have been used for BW agent production—and the design and construction of legitimate seed purification plants. Background on these two programs:

- **BW Program.** Prior to the 1991 Gulf war, Iraq possessed a BW program that had researched, developed, produced, and weaponized agents. After the war, Baghdad effectively hid its offensive BW program from UNSCOM inspectors for nearly 5 years. Iraq claimed to have destroyed its BW agents and weapons completely in 1991, but UNSCOM was unable to verify this claim. By the departure of UNSCOM inspectors in 1998, Iraq’s declared BW production capability in known fixed facilities had been dismantled.
- **Seed Purification Project.** Iraq’s mobile BW program reportedly began amid the UN inspection process and operated under the cover of the seed purification project facilities. ISG investigations show that the seed project began in 1994 on orders of Husayn Kamil as part of Iraq’s effort to improve and modernize its agricultural sector, and involved the creation of a total of ten legitimate, although inefficient and low quality, agricultural seed sorting and fungicide treatment systems that were designed

to have a greater capacity and less of a health risk than seed purification plants available to Iraq at the time. The seed purification units were designed, fabricated, and installed by the CDC. The designers considered producing a mobile system but decided on fixed plants installed in buildings. The final plant design was based on the reverse engineering of a German-manufactured seed purification plant in Tikrit. The seed purification project occurred in two phases, concluding in 1997 when all ten plants were transferred to the Mesopotamia State Company for Seeds, also known as the Al Nahrayn Company.

#### Denials of the Existence of Mobile BW

ISG identified nearly ninety individuals that could have been involved or were linked to sites or the source that became part of the investigation. Of these individuals, ISG located and debriefed over sixty. While many have corroborated some of the reporting on personnel and of the Sa’d Center and some legitimate activities the source claimed were cover activities, none have provided evidence to substanti-



ate the claim of a mobile BW program. The levels of cooperation from these individuals vary considerably, ranging from active cooperation to denials and evasiveness:

- Most of the individuals identified as being involved in the mobile BW program were associated with the CEDC and responsible for both the seed purification project and the single cell protein project that was the cover for the Al Hakam BW facility. ISG spoke to nearly all of these individuals and, while they have acknowledged their involvement in both of the projects, they have consistently denied the existence of a mobile BW program.
- Several key Iraqi engineers were debriefed. Each engineer denied both the creation of a mobile fermentation project and that the seed purification sites were used as legitimate cover for mobile BW agent production units. ISG officers found some of those interviewed to be less than forthcoming, but were unable to judge if the interviewees were withholding information on the alleged mobile BW project or some other project they did not want to reveal. Debriefings of High Value Detainees (HVDs) have not yielded any new insights into the existence of mobile BW agent production capabilities in Iraq.
- Personnel from Al Nasr Al Azim State Establishment, a company that produced fermentors, heat exchangers, and vessels for Al Hakam, have denied that they produced components for any mobile BW systems during the 1990s.
- Personnel from the Al Nahrayn Company denied that three of its sites housed mobile BW agent production units. ISG officers assess that the Al Nahrayn Company has usually been forthcoming and accommodating to requests for information and site visits. The current occupants of the As Suwayrah Store, Tikrit Industrial Facility, and Mosul Rail Station also deny that the facilities were utilized for transportable activities, as reported by the source. However, in the case of Tikrit, although the construction company that runs the site occupied the facility when the production units were allegedly present, current site personnel were hired after OIF and do not have historical knowledge of the facility.

## Exploitation of Mobile BW Agent Production Sites

Since stand-up, ISG has exploited many sites in Iraq identified to have a connection to the mobile BW program, including the five reported production sites that remained intact after the war (Figure 2). Discrepancies remain between past descriptions of sites and physical features at the sites as found by ISG. Investigations of six additional sites have not uncovered links to the mobile BW program, which may be partially due to post-OIF activities, such as turnover of employees and looting of facilities.

### *Djerf-al-Nadaf Seed Purification Facility, Reported Mobile Site.*

ISG teams visited this site six times to examine its physical features and debrief site personnel. The teams determined that the facility is in fact operated by the Al Nahrayn Company and it's involved in seed purification. A high-bay building adjoining the primary warehouse of interest was built in 1994 and contains a legitimate two-story high seed purification unit. However, ISG also discovered differences between physical features present at the facility and those reported pre-OIF.

- ISG officers were unable to locate any evidence of reported vehicle entrances on the ends of the building that was said to have housed the BW production unit. In the course of inspections, ISG found that the building is constructed of continuous sheet metal; there were no indications that the metal on the ends of the building was altered to accommodate and then conceal the past existence of doors. The current site manager, who is a long-time employee at the site, and an engineer involved in the seed purification project, denied the past existence of the doors on the ends of the building.
- Two two-meter-high block walls around three sides of the building prevent vehicle access into the building through these reported vehicle entrances (Figure 3). ISG determined that the walls were constructed by 1997, which is when the BW production unit was reportedly on site.
- Reportedly a small building on-site was the location of the power supply for the mobile production units. An ISG examination of the reported power supply building revealed that the building consists

of two small rooms, which site personnel explained were constructed for security personnel and technicians. These individuals said that the power supply for the site came from the local power grid. However, an external generator for electricity to certain places at the site cannot be ruled out.

ISG has determined that the primary warehouse has undergone some modifications since the date of information concerning a transportable BW connection to the facility. This indicates that the building was altered, thereby raising the possibility that other less detectable modifications have occurred:

- A one-meter high concrete wall was discovered around the internal perimeter of the building. Site personnel report that the wall was built in 1999 to prevent seeds from pressing against the sheet metal walls.

A tile floor was found in one corner of the building, indicating that a room had been present and removed. Site personnel indicate that an office was present in this location, but was removed in 1999 to accommodate the need for greater space required for the seed purification activities.

**Al Ahrar Seed Purification Facility, Reported Mobile Site.** ISG exploited the Al Ahrar seed purification facility, the primary candidate for the site in the An Numaniyah area that reportedly housed a mobile BW agent production unit. Exploitation revealed that, although it is operated by the Al Nahrayn Company and is part of the seed purification project, it most likely did not house mobile production units.

- The facility contains four adjoining warehouses, each large enough to accommodate semi trailers; however, it was determined that the doorways of the warehouses, assessed to have housed production units, are too short to accommodate tractor-trailers the size of the described mobile fermentation units (Figure 4). There were no signs that the doorways had been altered. In addition, site personnel deny the past presence of trailers with fermentation-like equipment. They stated that CEDC employees, including individuals allegedly involved in the mobile BW program had been to the site as part of the seed purification project. A high-bay building adjacent to the warehouses contains two legitimate seed processing units that are similar to the one unit located at the Djerf-al-Nadaf facility.

***Investigations of the four remaining reported production sites have yielded no evidence of their involvement in the mobile BW program:***

- ***Tikrit Industrial Facility Northwest, Reported Mobile Site.*** This site was a reported location of two transportable BW plants using the cover of seed purification. ISG exploitation of the site revealed that the warehouse, which is currently used as a storehouse for a construction company, was large enough to accommodate tractor trailers (Figure 5). However, ISG found no evidence to suggest that the building is or was equipped with false walls for concealment of any such units. In addition, the site personnel explained that the facility had been a plastics factory from the 1980s until the construction company took over the grounds. Although they had no first-hand historical knowledge of the site, the site personnel stated that the facility had no connection to seed purification and had not been used as a hide site for tractor trailers.
- ***Plant Protection Division As Suwayrah Stores, Reported Mobile Site.*** The As Suwayrah Stores was identified as the most probable candidate for the site in the Al 'Aziziyah-Sarabadi area. ISG exploitation of the site determined that the facility is a pesticide storage site with no association with the seed purification project. Measurements of the suspect warehouses indicate that the facility is large enough to conceal a mobile BW agent production unit; however, ISG has not been able to confirm if such a unit had been present in the past. Site personnel, who had been hired after OIF, had no historical knowledge of the activities at the facility; however Plant Protection Division Management with historical knowledge of the site deny that the facility was used to hide vehicles or production equipment.
- ***Mosul Rail Yards, Reported Mobile Site.*** The locomotive repair station at the Mosul rail yards reportedly was the location of the single rail-mounted BW agent production unit. While this site is not directly involved in the seed purification project, the current Director General of the Al Nahrayn Seed Company stated that the company was ordered to conceal seed purification equipment in the rail station during the 1998 Desert Fox campaign. An ISG inspection of the facility revealed that it is capable

of accommodating rail cars. However, long-time employees at the rail yard stated that the repair station had never been used to conceal unusual equipment, railcars, or trucks.

- ***Huwayjah Agricultural Facility, Reported Mobile Site.*** This site, which reportedly housed a BW production unit in the late 1990s, was completely destroyed by looters between 10 May and 26 November 2003. Al Nahrayn officials confirmed that their site in Huwayjah had been destroyed by looters and deny the past presence of mobile platforms for BW agent production. They stated that, while this site was an agricultural processing facility, it had no connection to the seed purification project.

ISG exploited three additional sites, but were unable to ascertain their link to the mobile BW program due to post-OIF activities, such as turnover of site personnel and looting:

- ***Al Mishraq Sulfur Facility, Possible Reported Dispersal Site.*** ISG assesses that the Al Mishraq Sulfur Facility could have been a dispersal site for the rail mounted BW production unit housed in Mosul. ISG exploitation of this site revealed no evidence of the unit, and site personnel claimed that they had never seen rail cars with fermentation-like equipment in them.
- ***Habbaniyah Barracks, Reported Dispersal Site.*** Reportedly, containers of BW material from the mobile units were concealed from UN inspectors by burial at the Habbaniyah Barracks. ISG exploited the site to find evidence to support this claim; however, looters had removed, among other things, a fence that reportedly would have provided a marking to assist in locating the burial site.
- ***Baghdad Unidentified Facility ‘Ali Ad Dayyan.*** This site, also known as Buetha, is along the Tigris just south of Baghdad and was reported to have been associated with the BW program personnel. ISG exploited the site and determined that it had been an orange grove and chicken farm at one time but could not confirm an association with the mobile BW program. However, locals stated that it had belonged to the Iraqi Government until 1998.

## Other Leads

In addition to information now judged unreliable from a key source, ISG also has sought to vet the reporting by other sources who indicated before OIF that Iraq had a mobile capability. ISG has not been able to corroborate this reporting, and these individuals are believed to be now outside of Iraq. Since it began its investigation, ISG also received information on a possible BW mobile capability from two other sources separate from those mentioned by the pre-OIF sources, but neither lead has confirmed the existence of a mobile BW agent production capability:

- Nu'man 'Ali Muhammad Al Tikriti, director of the M16 section of the IIS, made a reference to the MIC in 2000 having at least one transportable facility for work on either biological or chemical warfare agents, according to a former IIS officer. Nu'man denies knowledge of any attempts by Iraq to manufacture or use mobile facilities for a BW or CW program.
- A former senior officer in the Iraqi Army told us that he heard from his nephew, who was involved in making weapons, that Iraq had “portable biological factories or laboratories” making BW agents in 1998. Debriefings of the nephew have determined that he had hearsay information regarding movement of prohibited BW-related equipment to evade UNSCOM inspections. He claimed to have had no knowledge of a mobile BW agent production capability.

## Individuals Debriefed

ISG has debriefed key individuals and visited key sites regarding the planning, design, manufacture, and operation of the reported transportable BW agent production plants.

Some of these individuals were key players directly involved with running the BW program, whereas others were either heads or associated with specific areas of the BW program. ISG interviewed

key figures, such as the suspected head of the BW program, the former Deputy Minister of Agriculture, the National Monitoring Directorate representative to the Ministry of Industrialization and Minerals, the director of the MIC, the former Minister of Industrialization and Minerals, the Minister of Transportation and Communication that had involvement in the BW program, and other important individuals that had suspected involvement with Iraq's BW program.

In the area of mobile production equipment and facilities, there were a number of key individuals interviewed. Some of these individuals included the Director of IIS Directorate of Criminology M16 that reportedly discussed mobile platforms in 2000, the director of a possible dispersal site for rail mobile units, managers of a reported mobile BW agent production site, and a former military officer who allegedly knew that Iraq had "portable biological factories or laboratories" making BW agents in 1998.

## **Annex D Trailers Suspected of Being Mobile BW Agent Production Units**

**ISG assesses the capability of two mobile trailers with tanks or suspected fermentors on board that were recovered near Irbil and Mosul in 2003. ISG judged the mobile units were impractical for biological agent production and almost certainly designed and built for the generation of hydrogen.**

### **Background**

**Iraq's Consideration of Mobile BW Agent Production Systems.** Several events underpin the continuing suspicion that Iraq possessed mobile facilities and laboratories.

- In the 1980s, the Technical Research Center (TRC) at Al Salman purchased a mobile laboratory for forensic purposes in support of a proposed meeting of the Arab League or Arab Games in Baghdad. The meeting did not take place in Iraq, but Al Salman retained the laboratory.
- Later, in 1987 Dr. Rihab, head of the BW bacteriological group, and Dr. 'Amir Hamudi Hasan Al Sa'adi, MIC First Deputy and right hand man of Husayn Kamil, discussed the possibility of developing a transportable system for the production of BW agents. The idea was largely Al Sa'adi's; Rihab rejected the proposal in favor of the more pedestrian route that, in time, led to the construction of Al Hakam, Iraq's major BW research, development, testing, production, and storage facility (see Figure 1).

### **Discovery and Initial Exploitation of Suspect Trailer-Borne Equipment**

It was against this background that Coalition Forces discovered two trailers in Northern Iraq in April and May 2003. In April 2003, a trailer (trailer 1) was recovered after its discovery in Irbil. This trailer appeared to be complete with all equipment fitted. A second, similar trailer (trailer 2) was later identified and recovered in May 2003 from a site adjacent to the Al Kindi research facility at Mosul. Some items of equipment were missing from this trailer bed.

*Initial Assessments and Sample Analysis.* A team of military experts conducted a preliminary technical field investigation of trailer 1 soon after its capture. They assessed the trailer to be part of a possible Iraqi mobile BW weapon production system, with its equipment being capable of supporting a limited biological batch production process. A second examination was undertaken by a team of scientific experts, after Al Kindi personnel suggested the trailers were for hydrogen production. Their report concluded, "The trailers have equipment and components possibly compatible with biological agent production and/or chemical processes that might include hydrogen production."

### **ISG Assessment of the Trailers**

In response to questions raised by these earlier reports, a team, comprised of specialists in fermentation technology and bio-manufacturing, conducted a comparative assessment of the trailers with respect to the two major uses postulated:

- A clandestine mobile BW agent production platform.
- Field units for hydrogen production.

This assessment focuses on Trailer 1 because it appeared to have a complete set of equipment. The 'reactor vessel' was considered to be the key component of the system for evaluation because to determine its purpose as either a bio-fermentor or a chemical reaction vessel for hydrogen generation, would resolve the debate over the function of the whole assembly of equipment mounted on Trailer 1.

### **The Trailers as a Clandestine BW Agent Production Platform**

The crucial item of equipment for the production of BW agents is the fermentor. This provides and maintains an aseptic and controlled, optimal environment for growth of the selected microorganism. A fermentor, regardless of the particular microorganism being produced, be it BW agent or not, must possess certain essential design features in order to achieve these cri-



**Figure 1.** Recovered trailers allegedly for hydrogen production.

teria. The most critical of these is the ‘sterile integrity’ of the fermentor and its associated pipework, in order to maintain a monoculture and prevent the ingress of ‘foreign’ microorganisms that might outgrow and displace the required agent.

*ISG has found no evidence to support the view that the equipment had a clandestine role in the production of BW agents; and ISG judges the equipment’s configuration makes its use as a fermentor impractical for the following reasons:*

- There is a critical absence of instrumentation for process monitoring and control of the process.
- The positioning of the inlets and outlets on the reactor make even the most basic functions (such as filling completely, emptying completely, and purging completely the vessel) either impractical or impossible to perform.
- The lack of the ports required to introduce reagents exacerbates this problem. These aspects of the design alone would render fermentation almost impossible to control.
- The low-pressure air storage system capacity is inadequate to provide the volume of compressed air required to operate the fermentation process over a complete aerobic production cycle. In addition, it is not practical to charge and use the existing compressed gas storage with nitrogen or carbon dioxide for anaerobic fermentation. Similarly, the collection system for effluent gas would be wholly inadequate to deal with the volume of effluent gas produced during a complete production cycle.
- Harvesting any product would be difficult and dangerous.

Fermentor Design Feature	Critical Requirement Yes/No	Present on Trailer Vessel Yes/No	Required Reconfiguration Major/Minor
System sterilization	Yes	No	Major
Media/water sterilization	Yes	No	Major
Aseptic growth conditions	Yes	No	Major
Agitator/stirrer	Yes	No	Major
Aeration sparger	Yes	No	Minor
Process control instrumentation & sensors	Yes	No	Major
Addition and sampling ports	Yes	No	Major
Sight glasses	Yes	No	Major
Provision of sterile air	Yes	No	Major
Sterile filtration of off-gas	Yes	No	Major
Provision of steam for sterilization purposes	Yes	No	Major

Table 1 illustrates the assessment of the ‘reactor vessel’ and associated equipment system on trailer 1 against the essential features of an effective fermentor. (*Note: there are additional, minor design inconsistencies, which are not included in this table.*)

- A working reactor of the size of that on the trailers could produce only around 100 liters of x10 concentrated BW agent per week, not enough to fill a single missile warhead.
- In May 2003, analysis was carried out on seven samples taken from key equipment locations on the trailer, including powder and slurry taken from the ‘reactor vessel’. No evidence of BW organisms was detected. The complete absence of proteins and the minute amounts of phosphorus and sulfur present were deemed inconsistent with normal bio-production.

## The Trailers as Field Units for Hydrogen Gas Production

*After re-examining the equipment found on trailers in northern Iraq and reviewing previous reporting, documents, and results of chemical and biological analysis, ISG judges that the Al Kindi General Establishment at Mosul designed and built the two trailer-borne equipment systems as hydrogen generators for Republican Guard artillery units for use with radio-sonde balloons. Although the equipment is poorly constructed, it is consistent with the hydrogen generation process detailed in documents from the Al Kindi Company.*

*The equipment on Trailer 1, although poorly constructed, is consistent with the hydrogen generation process because:*

- The reactor design and sizing, large entry port to “load” the reactor, the scoop to “load” the reactor and aluminum hydroxide found in the bottom of the reactor are all consistent with production of hydrogen. Hydrogen may be produced by reacting sodium hydroxide with aluminum powder and water. The rate of reaction, and the temperature and pressure in the reactor is controlled by the rate at which water is added. The by-product is aluminum hydroxide.
- A peristaltic pump to compress the effluent gas is necessary for handling flammable products.
- A high-capacity cooling system for the reactor is consistent with the duty associated with a strongly exothermic process, such as that used for the production of hydrogen.
- A pressure-relief valve with a vent extending above the vehicle, spark resistant lighting, and a telescopic lightning arrestor found on the completed trailer indicate precautions taken with the handling of a flammable, lighter than air gas, such as hydrogen.

*Moreover, reports and other documents provided by high-ranking officials from Al Kindi, detailing milestones in the manufacture and testing of the trailers, are consistent with the reporting on their stage of construction.* For example, the date of the

Iraqi letter requesting an extension of the contract due to late delivery of a 'reactor vessel' corresponds with the observed lack of construction work on Trailer 2.

- The two trailers were located in late May 2002 at the Al Kindi facility in Mosul. Reporting indicated that at least one of the trailers had arrived on the site as a bare chassis fitted with a floor/bed. Over a period of 10 months between May 2002 and March 2003, both trailers had had sufficient equipment added to be described as two 'possible transportable BW production related trailers'.
- The location of the trailers, together with the addition and removal of structural features and equipment during their construction and testing, is consistent with information in Iraqi reports and documents.

*Iraqis have stated the trailers were constructed to provide a mobile capability for hydrogen gas production. Several documents give credence to this claim.*

- Al Kindi in its submission for the December 2002 semi-annual declaration to UNMOVIC stated a "production station for H<sub>2</sub> gas (see Figure 2)."
- A letter from the Al Kindi General Company to the 'American Authority' in Mosul, explains that the trailers were manufactured as 'hydrogen field production systems' for the Republican Guard.
- Copies of the original contract and associated documents that describe the requirements, specifications and testing were provided by sources that had first hand knowledge of the manufacture and use of the trailers.
- The Al Kindi Material describes the process employed on the trailers as an attempt to improve upon one originally developed in Russia for the production of hydrogen for use in meteorological balloons.
- It is interesting to note that the Al Kindi material also includes comments (some of which are not particularly favorable) received from the Iraqi Republican Guard Artillery in relation to the suitability of the process for the job it would be required to

```

Site_cod : KINDI
Rep_no   : RND-17
Ref_date : 2002-12-15
Or_fac_nam : ALKINDI STATE ESTABLISHMENT.
Cr_fac_nam : ALKINDI STATE ESTABLISHMENT.
Owner    : MIC
Operat   : ALKINDI STATE ESTH.MOSUL,ALABABI QUARTER, P.O.BOX(11)
Location : MOSUL,ALABABI QUARTER.

Geo_coord : N:36 23 97 E:43 08 17
Post_addr : MOSUL,AL-ARABI QUARTER,P.O.BOX 11
Telephone : (060)763958 OR 763949
Telefax   :
Fax       :
Lias_off  : ENG. K. S. MOHAMMED.
Fin_source : MIC
Elect_cap : 13.5 mwe

Eis_diagr : SEE ATTACHMENT 1-1
Eis_design : ATTACHMENT 1 2
            THE COMPANY IS DESIGNED TO CONDUCT THE FOLLOWING
            ACTIVITIES:
            * SMALL CALIBER AMMUNITIONS DEVELOPMENTS.
            * SMALL TACTICAL MISSILES TESTING AND
              DEVELOPMENTS.
            * SOLID PROPELLANT IMPROVEMENTS.
            * MATERIAL TECHNOLOGY STUDY AERODYNAMIC TESTING.
            * SMALL ROCKET MOTOR TESTING.
            * ELECTRONIC AND LASER RESEARCHES.
            * ELECTRONIC INSTRUMENTS CALIBRATION.

Eis_activ  : ATTACHMENT 1 3
            1. $$$ TV CORRECTOR FOR SUBMATE-SURFACE MISSILE
              ARABAL 50. (600)
            2. $$$ FIRING ORDERS SOFTWARE FOR ALABEL 50 &
              AL-FATIR & AL-SUMOOD.(600)
            3. *** AGEING OF DIFFERENT TYPE OF MISSILES
              AXOZET, HOT, MILAN TOW, S530, AS30L, R24,
              BOMBS (BURENDAL). (500)
            4. *** DESIGN OF TWO REC CENTERS FOR DATA ANALYSIS
              FROM MIRAG F1, JET FIGHTER (EMU). (700E)
            5. $$$ PRODUCTION STATION FOR H2 GAS FOR METROLOGICAL
              PURPOSES. (500G)
            6. *** IMPROVING THE III SYSTEM OF S330. (700)
            7. ## RADAR JAMING BALLETS. (400)
            8. *** FABRICATION OF DIFFERENT TYPES OF WAVE GUIDE FOR
              ROLAND, SAMPLIN, AXOCET RADAR SYSTEM. (700)
            9. $$$ PRODUCTION OF KYLIDEN FUEL FOR AL-SUMOOD MISSILES.
            10.*** STUDY AND PRODUCTION OF NICKEL POWDER (500G)
            11.#### PREPARATION OF ANTIMONY OXIDE [Sb2O3] (500G)
            12.#### STUDY OF PREPARATION OF TRIPHOSPHINE OXIDE (MAD) (500G)
            13.#### SYNTHESIS OF CENTRILETE MATERIAL WITHOUT USING
              PHOSGENE (500G)
            14.#### STUDY OF PREPARATION TRICRETE PHOSPHATE [TCP] (500)
            15. $$$ DESIGN AND PRODUCING OF NITROGEN GAS UNIT (500)
            16. ## DESIGN AND PRODUCING RADIOISOTOPE BATTERIES (500)
            17. ** MODIFICATION KAFADRAT MISSILE TO WORK ON PASSIVE MO
              USING RADAR HOMING HEAD OF S-80 MISSILE. (600 & 700)
            18. ** MODIFICATION OF VOLGA MISSILE TO OPERATE IN C - DAN
              SEMI ACTIVE. (700)
            19. ** MODIFYING KAFADRAT MISSILE HOMING HEAD FROM OLD MO
              TO NEW MODEL ( M1 to M3 ).(700)
            20. ** STUDY THE POSSIBILITY OF INCREASING THE RANGE OF "M
              MISSILE. (600)
            21. *** DESIGN AND MANUFACTURING OF MODIFIED (122 mm) ROCK
              MOTOR. (500)
            22. *** Study Volga to work at X-band. (700)
            23. *** DESIGN AND MANUFACTURING OF S530 ROCKET MOTOR.
            24. ** TESTING AND REPAIRING OF ROLAND (GROUND-AIR MISSILE)
            25. ### STUDY THE POSSIBILITY FOR DESIGN AL-BARQ MISSILE (500)

            26. ## TESTING AND REPAIRING OF MALTA, VACOT, CONCURS (A
              TANK) MISSILE (500 & 600)
            27. *** REPAIRING OF R40,R29 TEST STATION (600)
            28. *** TESTING & REPAIRING OF THE THERMAL SEARCHING SYSTEM
              FOR MIG-23 AIRCRAFT (600)
            29. *** TESTING AND REPAIRING OF LGI TEST STATION (600)
            30. *** STUDY THE POSSIBILITIES FOR TESTING AND REPAIRING
              F1 AIRCRAFT SIMULATOR (700)
            31. *** STUDY THE POSSIBILITIES OF REPAIRING THE ATEC STATION
              (AUTOMATIC TESTING EQUIPMENT CENTER) (600)
            32. *** PREPAREDNESS THE LASER-TV SIGHTING UNIT OF
              THE SU AIRCRAFT (700)
            33. ## PREPAREDNESS THE HANG FINDER SYSTEM (OSTO)
              OF THE HELICOPTER (700)

            THE CONSUMER :
            -----
            * AL-KINDY EST.
            ** AIR DEFENCE.
            *** AIR FORCE.
            **** SALAH AL-DERFI GENERAL COMPANY.
            ##### AL-RASHIED GENERAL COMPANY.
            $$$$ RESEARCH OFFICE.
            # ARMY (ARMOR FORCE).
            ## ARMY (HELICOPTER FORCE).
            ### MIC.
            $ ARMY (INFANTRY TROOPS).
            $$ MINISTRY OF TRANS & COMMUNICATIONS.
            $$$ SURFACE-SURFACE MISSILE FORCE.

            ECONOMIC AFFAIRS
            * SALARIES AND WAGES 200 MILLION I.D.
            * OPERATION COST 500 MILLION I.D.

            Notes : NONE
  
```

Figure 2. Document denoting alleged "hydrogen production" function.



do. In summary, their conclusion is that the process plant/trailer combination is too bulky and that the trailer is not rugged enough for the process to be considered a truly mobile “field” system. A smaller capacity plant might be more compatible with the needs of meteorological units requiring self-sufficiency in terms of hydrogen availability.

- The level of detail provided in the Al Kindi Material makes a highly credible case for hydrogen generation. It would have been extremely difficult to fabricate data to this level of detail.

### Detailed Assessment Of The Suspect Trailers Recovered From Irbil and Mosul 2003

#### Evaluation of the Possible Use of the Trailers as a clandestine BW Agent Production platform

##### Air Supply

Air is used in the process to provide aeration for the reactor, for transferring liquids as required throughout the process, and after the production cycle for purging vessels and pipework that have had contact with the inoculum, the culture broth, and/or contaminated gases. Air is drawn into a low pressure (0-40 bar) compressor set via a simple activated carbon filter F-2, compressed and fed to the integral storage reservoir (S-11) of the compressor set. Compressed air from the compressor reservoir is fed either directly to the reactor via vessel T-3 or to a bank of five 40l “K” bottles (S-1 to S-5). The air stored in this cylinder bank is available as an emergency reserve for use to shunt liquids around the process as required without having to rely on the compressor set. The air supply system may be vented via Valve V-3.

---

#### Major Components of the Trailers

**The Trailers.** Both trailers had been used previously, probably as transporters for heavy construction equipment and the like. They show signs of damage and wear, such as a heavily dented and uneven truck bed. They are of different lengths. There is a tube frame with horizontal welded steel straps to support a canvas cover. The frame also supports light fittings.

**The Equipment.** The principal items of equipment mounted on the Irbil trailer are:

- **Chiller.** The forward portion of the trailer is almost entirely occupied by a large chiller unit, capable of pumping copious volumes of cold water through a pipe circuit to other items on the trailers. The chiller is powered by electricity.
- **Electrical Switch Panel.** On the side of the trailer, there is an electrical control box.
- **Low Pressure Air Compressor.** An electrical air compressor fed from the atmosphere through a small filter is attached to a reservoir.
- **Bank of 5 Air Storage Cylinders.** The pipe work from the air compressor connects with 5 fixed air bottles.
- **Large Water Tank.** Near the center of the trailer is a large stainless steel water tank that connects to the water pumping system. The tank is provided with a loose fitting lid. It is not sealed.
- **2 Feed Tanks.** After passing through a very small filter, water can be metered and pumped into two tanks.
- **Reactor Vessel.** To one side toward the rear of the trailer there is a reactor fabricated in stainless steel by the State Establishment for Heavy Equipments Engineering (SEHEE), Baghdad (see Figure 3 (a) and (b)).
- **High-Pressure Compressor.** After cooling, the gas produced by the reactor is compressed in a high-pressure compressor housed in a strong steel box.
- **Bank of 5 Product Storage Cylinders.** The compressed gas is fed into 5 storage bottles, held in a box that can be rotated to ground level to assist with handling of the product (see Figure 4).



Figure 3 (a). Trailer 1 reactor vessel.

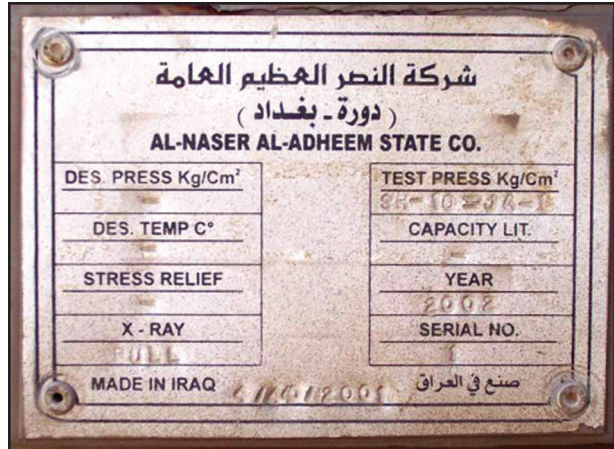


Figure 3 (b). Trailer 1 data plate on reactor vessel.



Figure 4. Trailer 1 box for holding product 'K' bottles.

#### Comment and assessment

- The simple filter F-2 is not of a design that will provide sterile compressed air to the process. A HEPA filter could be fitted to address this problem, although this would not be a minor modification.
- Large amounts of compressed air are required for each production cycle (see 2.6) and the risk of contamination (failure) of any given batch is increased if process air is not sterilized.
- The low pressure compressor set is of standard reciprocating design and will not provide “oil-free” air. Oil-free air compressors are often specified in fermentation installations though in this particular concept (i.e. the production of “fire-and-forget” BW agents), it is unlikely to be a critical factor.
- These trailers were not designed with anaerobic fermentations in mind. Although it would be possible (but extremely inconvenient) to connect nitrogen cylinders to the sparge system, it is noteworthy that no provision has been made on the trailers for the

storage of gas cylinders other than the five designated for air storage. These cylinders are permanent fixtures and cannot easily be removed/substituted with other gas cylinders containing N<sub>2</sub> or CO<sub>2</sub>. ISG concludes that anaerobic fermentations (e.g. *Cl. botulinum* and *Cl. perfringens*) would not normally be conducted on the trailer.

## Water Supply

Water tank T-1 provides water for dilution of medium concentrate, for wash-down, for charging the chilled water system, and for chiller system make-up. Dilution and/or wash-down water can be introduced to the process by 2 routes:

- Indirectly, via pump P-1 and valve V-8 into vessel T-2. This route could be used for providing process water for medium concentrate dilution (see 2.4) to the reactor. When full, vessel T-2 is isolated from the system (at V-8), vented (at V-9), and its contents delivered via flowmeter FM-1, cartridge filter F-1, and positive displacement pump P-2 into the reactor (T-4). [N.B. The reactor must also be vented during this process via the overpressure relief assembly bypass valve (V-15)].
- Directly (and quickly): into vessel T-3 via valve V-7 and pump P-1. This route would be used for providing water for wash-down or cleaning, and possibly as part of the postproduction purging cycle.

### Comment and assessment

- The simple cartridge filter (F-1) is not of a design that will provide sterile water to the process. This filter assembly is located at very low level. The whole filter assembly would need to be repositioned and repiped if a sterile water filter is to be fitted. This is not a minor modification.
- Vessels T-2 and T3 lack any form of liquid level indication and will be difficult to use when fed by pump P-1.

## Chilled Water System

The chiller system provides cooling water to the reactor, the gas-drying condenser, and the high-pressure gas compressor.

Prior to first operation, the chiller circuit must be filled with water from the water storage vessel T-1. When this has been done the system should require little by way of make-up water because it is a sealed system and little evaporation can occur. Cooled water is circulated around the system by pump P-3

### Comment and assessment

- Notwithstanding the other loads on this process (H.P. compressor and effluent gas cooling), ISG believes that the cooling load presented by a relatively small fermentation operation at perhaps 30°C - 40°C (a typical temperature range for *B. anthracis*) does not justify a cooling plant of the size specified for the process as found.
- However, it would be fair to say that the output of this unit can be modulated and the fabrication shop may not have had the luxury of choice and was obliged to use equipment available at the time.

## Metered Water Supply System (Vessel T-2)

The metered water supply system comprises a vented supply vessel (T-2), a flowmeter, an in-line cartridge filter (F-1), and a dosing pump (P-2) (see Figure 5).

Note that vessel T-2 can only receive water from the main water tank. It may receive other liquids through the vent valve V-9 so long as the vessel is aspirated via vessel T-3 and the air supply line vent valve V-3. The valve arrangement does not allow liquids to be received from tank T-3.

### Comment and assessment

- Vessel T-2 is not equipped with any form of liquid level indication and will be difficult to operate because of this.



**Figure 5.** Trailer 1 water filter.

- The glass fiber cartridge filter F-1 will not remove all microbial contaminants from the water supply and therefore the process water treated by this means will not be sterile. In ISG’s view, neither the medium concentrate nor the inoculum should be introduced to the process via valve V-9. The medium concentrate is a complex medium and may contain aggregates that will collect on and bind the in-line cartridge filter F-1. The inoculum will have been prepared under sterile conditions and it makes no sense to filter things that are already sterile.
- A large amount of process water is required for each production cycle (as dilution water and for system purge). The risk of contamination (failure) of any given batch is increased if the process water is not sterile. In this regard, it is important to ensure that the initial seed culture contains sufficient viable organisms in log phase to ensure that potential contaminant microorganisms cannot compete.
- Vessel T-2 would be ineffective if used for dilution water either. Running the water through a filter that is incapable of removing any solids smaller than fine sand particles will make little difference to the fermentation performance. Some 360-390 liters of dilution water is required for each production run. Given that the capacity of vessel T-2 is 166 liters, this vessel would need to be recharged twice during the operation. The maximum flow rate for the metering pump is only 30 liters/minute. This makes charging the reactor an unnecessarily lengthy operation.

### **Inoculum and concentrated culture medium vessel (T-3)**

Vessel T-3 is piped up to receive process water (see 2.2). It may also act as a transfer vessel for the inoculum and the growth medium (possibly as a concentrate) via valve V-12. If used in this way, vessel T-3 must first be aspirated through valve V-3 on the air line. The inoculum and the growth medium would be transported to the trailer in pressurizable containers with suitable fittings such that the contents could be “blown” into T-3 by using either a foot pump or from the onboard air storage via a flexible hose.

During the production cycle, vessel T-3 needs to be empty because all process air required by the reactor has to be passed through it.

#### ***Comment and assessment***

- The purpose of vessel T-3 is not entirely clear. It is a totally closed, unlagged tank having neither a dedicated vent nor a liquid level indicator. A difficult vessel to use.
- The only ways to vent this vessel are via valve V-3 on the air supply line or through the reactor and out via the over-pressure bypass valve V-15. Neither method would be available during the production cycle because the air supply system will already be in use.
- As piped up, liquid contained in vessel T-3 cannot be passed to vessel T-2. This means that neither the medium concentrate nor the inoculum can be metered into the reactor. Also, it means that the only entry point by which concentrated medium and/or inoculum can gain access to the process is via vessel T-3.
- Steam and/or hot water required (provided from a stand-alone utilities vehicle) would be admitted to the process via valve V-12.
- There is no convenient coupling present at valve V-3 for attaching temporary hoses for passing steam, inoculum, or concentrated growth medium into vessel T-3.

- During the production cycle, vessel T-3 must be empty because process aeration is required.
- It is assumed that the air feed pipe does not extend into vessel T-3 because, if it did, the vessel would be impossible to fill.

## Reactor

The reactor (vessel T-4) is a vessel fabricated in 30mm 316 stainless steel and is of an unusual design for the cultivation of microorganisms in that its principle features are:

- A flat base and a hemispherical top
- With the exception of what would be the air sparge inlet and the drain point, all other connections and the access way are side mounted
- The vessel jacket (3mm 316 stainless steel) completely covers the top of the reactor within but the base of the vessel is not cooled.
- There is no means of assessing liquid level in the vessel.

The vessel is provided with an air supply, an over-pressure safety relief valve plus manual bypass, a drain point, an effluent gas outlet, a temperature gauge, 2 pressure gauges, and a spare unused instrument stub. The vessel jacket is provided with two chilled water inputs, one cooling water return port, a temperature gauge, and a pressure gauge.

If the process were to be used as a mobile BW agent production unit, vessel T-4 would be used for the production of the BW agent. The inoculum (prepared elsewhere and delivered to the Trailer), the growth medium (prepared elsewhere and delivered to the Trailer probably would be supplied as a concentrate) and dilution water are fed into the vessel. Stirring and aeration of the culture is achieved by injecting low pressure compressed air into the reactor (presumably through a sparge ring). Used air could escape from the reactor through the effluent gas outlet connection.

## Comment and assessment

- **Reactor capacity.** The dimensions of both reactors (the Mosul Trailer and the Irbil Trailer) were taken, and these measurements are represented on a diagram in the appendix. The reactors are, for all intents and purposes, of the same capacity. The internal height of the reactor is 1873mm and its nominal capacity is 864.5l. Bearing in mind that the placement of the reactor connections limits the extent to which the reactor can be filled in practice, the total usable capacity of the vessel (i.e. to the level of the effluent gas outlet) is 633l. All fermentations are prone to foaming. A sight-glass permits operators to monitor the foaming and hence control it by adding reagent or adjusting other parameters. This design has no sight-glass. Under no circumstances should any liquid be allowed to enter the gas recovery system as this would, after a short time cause the catastrophic failure of the high pressure compressor. This imposes a limitation of the maximum volume at which the reactor can be operated. ISG would expect the working volume of this vessel to be in the region of 450l (approximately 70% of the total usable volume of the reactor) (see Figure 6).
- **Aeration & stirring.** The air supply pipe penetrates the vessel only to a depth of approximately 973mm leaving a distance of 900mm between the end of the air supply pipe and the base of the reactor. The sparge tube must extend to the base of the reactor if any aeration and stirring is to be achieved, but no sparge assembly or even a flexible hose of suitable diameter has been found. In one Trailer (Mosul - the less complete of the two), the air supply pipe is threaded presumably to receive an air sparge ring attachment whereas in the other Irbil Trailer the air supply pipe has no thread or other fitting. That there should be a difference between the sparge tubes is somewhat puzzling. The most efficient way to achieve maximum oxygen transfer rate is to use an impeller (mechanical stirrer) under turbulent flow conditions. Direct air injection alone will provide some mixing of the reactor contents but is not an efficient method of transferring oxygen into the culture medium. The consequence of this is that this reactor will require much more air than would be necessary under the impeller option (see Effluent Gas Collection).



**Figure 6.** The inside of the reactor vessel on trailer 2.

- **Vessel venting.** The vent valve of the reactor is not fitted at the top of the vessel as would normally be expected but rather at the side 1,260 mm above the base of the reactor. This distance corresponds to the highest venting points of the reactor (the emergency pressure relief outlet and the effluent gas offtake). This means that the reactor cannot be filled to capacity (e.g. for cleaning). As noted in above, the total useable volume of the reactor is 633 liters and the useable working volume will be 450 liters.
- **Antifoam addition.** There is no antifoam addition point on the reactor and no sight-glass by which to gauge whether or not antifoam addition is required. Although antifoam may be incorporated in the culture medium as a standard component medium prior to its introduction to the reactor, it is unusual to find that the production cycle can be completed without the addition of further amounts of antifoam. The construction of the reactor indicates that this process will be conducted at pressures up to 10 bar gauge; under such conditions the culture would be particularly prone to foaming at certain times during a normal production cycle (e.g. at start-up of the effluent gas collection compressor and at sample collection).
- **Process monitoring and control.** The reactor vessel is not provided with any probe port(s), or a sampling port. An assessment in a previous report postulates that the operators of the plant would run the process according to a standard operating procedure and would require no knowledge of the agent being produced. pH change is normally monitored during the production cycle. Culture mediums are usually buffered to cushion the effect of microbial activity as the production cycle progresses but, more often than not, the addition of acid or alkali is usually required at some point during the cycle. An addition port would be required on the reactor for this purpose. Dissolved oxygen concentration is also an important parameter (particularly in cases where the aeration system is not efficient. A probe location point is required for this. ISG maintains that without these monitoring and control items, any fermentation would be almost impossible to control.
- The level of instrumentation provided is insufficient for the purpose of producing BW agents on a routine basis. Without sight glasses or level indicators it is impossible to assess liquid levels in any of the vessels. Furthermore, the process would need to be pressurized (layout and disposition of vessels will not permit gravity flow from one place to another) and as such would be very hazardous to operate when producing highly toxic BW agents. Technical operators would have to be aware of the nature of the work they were conducting.
- **Reactor harvest and cleaning.** Reactor discharge takes place via drain valve V-14 into a length of ½” (inner diameter) pipe extending over the edge of the trailer (see Figure 7). It would be normal to see some form of coupling or flange on the discharge pipe but the end is not even threaded. As it stands, the only way to transfer the reactor contents would be to push a flexible hose over the discharge pipe outlet. The reactor contents would have to be “blown” by compressed air to a container or equipment of some kind, either on the ground or on another vehicle—making it an unnecessarily risky operation. There are no suitable receptacles on the trailer. The drain valve is sited some 2cm above the floor of the vessel. This means that the reactor can



**Figure 7.** Outlet valve and pipe on the reactor vessel of trailer 1.



**Figure 8.** Solids in the bottom of the reactor vessel on trailer 1.

never be completely emptied. To carry over some of the culture to the next production cycle will not cause any problem (apart from a reduction in productivity) so long as the culture remains sterile. Where it is critical is in the event of a contaminated or failed batch. Removing by hand the highly toxic remnants of the failed batch from the reactor would be no easy task. At Al Hakam, Iraq's principal BW facility, the production run failure rate was reported as running at 10 to 20 per cent. The production conditions were far better than they would be on these trailers, so ISG would anticipate high failure rates using this process as a mobile BW agent production platform.

- Sampling. No dedicated sample port is provided. The only means of sampling mid-cycle would be from the drain valve located at the base of the reactor. The dispositions of the drain valve and the outflow of the discharge pipe are such that two operatives would be required to perform the sampling operation (see Figure 8).

### Productivity Issues

With a working volume of only some 450l, this reactor could hardly be described as a production scale unit. Each cycle will be approximately 48 hours in duration (a culture time of 36 hours plus 12 hours turnaround) and would be expected to yield only some 45 liters of 10x concentrated BW agent. On this basis, 2 production cycles (at least 4 days' production) would be required to produce sufficient BW agent to charge a single R-400 bomb (Fill capacity of 90l).

### Effluent Gas Handling

Effluent gases from the reactor exit the vessel and are cooled by passage through the condenser/cooler X-2. Condensate is collected in the knock-out pot T-5 and the dried gases are passed to a high pressure compressor via a particulates filter F-3. The gases are

compressed to approximately 100 bar and passed to a storage bank comprising five 40l “K” bottles (S-6—S-10) such that the process as a whole presents a zero effluent signature (i.e. all air input during complete cycle, less an amount of oxygen removed for respiration, but plus, the carbon dioxide respiration product). Some personnel who have exploited the equipment maintain that if this system was to produce BW agent then the effluent gases would be collected in order to reduce the risk of detection.

### ***Comment and assessment***

The notion of collecting and storing effluent gases from this process is a completely impractical and unnecessary proposition and is discounted. ISG found no testimony or evidence, physical, documentary or circumstantial, to support any such procedure.

- Air requirements. Conducted at ambient pressure, a mechanically stirred reactor will normally require an air flow of 0.5 x the reactor working volume per minute at the start of the process cycle. The air rate will increase to around 1.0 volume per minute as the cell density increases. In this case, the reactor working volume is 450 liters and if a 36-hour fermentation run is assumed at an average air flow rate of 0.75 reactor working volume per minute, the total air consumed for the complete cycle will be  $450 \times 0.75 \times 36 \times 60l = 729,000l$  ( $36m^3/hr$ ). Note that this estimate is conservative because it assumes air rates characteristic of mechanically stirred vessels. The reactor on the trailer has no stirrer.
- Storage capacity. In contrast to this, the 5 x 40l “K” Bottles, each pressurized to 100 Bar, would hold the equivalent of a combined storage ability of  $(5 \times 40) \times 100 = 20,000l$  of air from the reactor if at atmospheric pressure. When set against the 729,000l of effluent gases produced during a single production cycle, the effluent gas storage system capacity falls far short of the duty required.
- It is unknown what would happen to “K” bottles once pressurized. The operators would still have to take them away for discharge.

### **Evaluation of Other Possible Uses of the Trailers**

Although a number of uses have been proposed for the trailers, ISG found no evidence to support those uses. It is the view of the ISG that none is feasible.

- A number of potential uses have been suggested for the trailers:
  - Possible Reverse Osmosis Water Purification Unit (ROWPU)
  - Possible Chlorinization [*sic*] Plant
  - Possible Chiller Plant
  - Possible Desalinization [*sic*] Plant
  - Possible CW Production (least likely)

Although the chiller unit could obviously be used on a stand-alone basis, there is no evidence to support any of the remainder, thus they are discounted.

### **Evaluation of the Technical Detail in Documents Pertaining to the Trailers Recovered From the Al Kindi General Establishment**

#### **Process Outline**

The process is a hydrogen generator. For the production of  $1m^3$  of hydrogen, the Russian equipment required 1Kg Al powder, 100g of NaOH (solid crushed), and 6l of water. The reactor size was 60l. Rudimentary means of cooling of reactor contents and product  $H_2$  was provided. The Iraqis identified the following problems with the Russian system:

- Thermal runaway of the reactor (lack of effective cooling and temperature readouts).
- Lack of control of gas flow during hydrogen generation because of the use of flexible hoses and lack of pressure regulation systems (operator hazard judged “high”).



- Process was skid mounted and was heavy and difficult to handle.
- Russian version of the process was suitable only for filling balloons directly, there being no gas storage capability.
- There was no pressure relief valve (PRV) on the reactor.

The Iraqis set about designing and building an improved version of the Russian equipment in order to overcome the above limitations. Specifications of the major equipment items are listed.

### Major Equipment Items

#### Main Reactor

Produced by Al Nasr Al Azim Company in stainless steel 316; pressure tested to 16 Bar gauge; wall thickness 30mm; reactor internal diameter 800mm; height 1,150mm; manway access diameter 400mm; 2 x pressure gauges; 1 x temp gauge; 1 x safety valve; gas draw-off pipe diameter ½ “ stainless steel; reactor jacket fabricated in stainless steel 304 thickness 3mm; annular depth 100mm; height 1250mm; cooling water inlet/outlet diameter 2”; 1 x temp gauge; 1 x pressure gauge; reactor gas draw-off pipe contained within cooled water jacket extension; complete assembly mounted on 1,500 x 1,500 s/s316 baseplate with height of 30 mm.

#### High Pressure Air Compressor

Diaphragm type with capacity of 4-10 ft<sup>3</sup>/min at 400 Bar. Fed by gas from the reactor after having passed through a condenser stage to remove water vapor and a particle filter. After compression, the gas is fed to filling pipes via a pressure regulator valve.

#### Water addition system (to reactor)

High pressure pump at 30 Bar is used for this purpose. Water can be drawn from either the main tank (working volume 2,500 liters) or from the secondary tank (working volume 100 liters). All water passing to the main reactor is measured by an in-line water meter.

#### Air Bottle Storage System (20 Bar)

5 x K Bottles provided to supply air. This system is connected to the secondary tank (working capacity 100 liters).

#### Chilled Water System

Twin cooler/4 x Fan assembly. Output 35 cooling tons with an outlet temperature of 5°C-10°C. Motor rated at 35 HP DWM Kaplan. Circulation pump capacity is 40m<sup>3</sup>/hr.

#### Motor Control Center

Contains all switches, starters, relays, and ancillary equipment necessary for the operation, monitoring, and control of the process.

#### Trailer

The entire plant is mounted on a trailer (12m x 3m) and 4m high (see Figures 9 and 10).

#### Process Description

This is a batch process designed to produce sufficient H<sub>2</sub> to fill 5 x 40l “K” Bottles to a pressure of between 45-50 Bar. This requires 10-12kg of Aluminum powder (200-300 micron), 1-1.5kg flaked/granulated NaOH, and 25-30 liters of water.

Aluminum powder is distributed in an even layer over the base of the reactor and the NaOH layered over it. The reactor is sealed and water is added according to the following schedule:

- 5 liters (monitoring increase in pressure to between 1-2 Bar).
- 5 liters (monitoring pressure rise to between 3-3.5 Bar).
- 5 liters (monitor pressure to 4 Bar). Start draw-off and compress the gas to the storage cylinders for 3 hours.
- Add the final 10 liters of water and continue drawing off the gas evolved until a cylinder pressure of 45-50 Bar is reached. Reactor temperature should not be allowed to exceed 50°C during the above procedure—cooling water is normally only used in the summer months because it slows down the reaction.

---

### ***The Opinions of the High-Value Detainees (HVD)***

*Shortly after the discovery of the trailers, five HVDs and one senior Iraqi scientist were shown the equipment and their opinions were noted. The six individuals all had intimate involvement with Iraq's BW program, or its concealment. All denied having seen the trailers previously or knowing anything about them. They were puzzled and offered a wide range of opinions. Those who were asked dismissed the suggestion that they were for the production of hydrogen.*

- *Dr. Rihab Rashid Taha Al Azzawi, head of the bacteriological BW program, was quite sure it was not a BW laboratory because of the absence of a steam generator, appropriate filters, essential instrumentation, and ports for adding reagents.*
- *Prof. Nasr Husayn Al Hindawi, who was an advisor to Dr. Rihab and not a detainee, was "95%, or maybe a little less" sure that they were for biological use. Prof Hindawi had also been shown photographs of the equipment.*
- *Dr. Mahmud Farraj Bilal Al Samarra'i, responsible for weaponization aspects of the BW program, said they were not for CW agents; he was "85% sure" they were for BW, later he dropped this to 80%.*
- *Dr. 'Amir Hamudi Hasan al Sa'adi, a chemical engineer and Senior Deputy at MIC to Husayn Kamil, explained "Anyone who told you this is bio should be fired." He pointed out that it was also unsuitable for CW agent production. Later he put forward a theory that they were designed to produce enhanced fuel for SA-2 missiles as part of the Iraqi Air Defence effort. He claimed the energetic fuel would increase the range of the weapon system.*
- *Minister 'Abd-al-Tawab 'Abdallah Al Mullah Huwaysh, former Minister of Military Industrialization and head of MIC, was sure that it was not biological; he thought it was a chemical process, but not military, although it might be for producing a payload for a UAV.*
- *Husam Muhammad Amin Al Yasin, Head of the National Monitoring Directorate and a missile expert, did not express an opinion about use, but stated that the vessels should have been declared to the UN, and if this had not been done it was a clear violation.*

The high-pressure compressor is set to provide compressed hydrogen at 45 Bar to the 5 "K" Bottles. On completion of filling, the filler regulator valve is closed and the compressor switched off. The reactor and process pipework are depressurized and the whole system vented to air.

After every 2 or 3 runs, the residue (a mixture of NaOH/Al(OH)<sub>3</sub>/Al) remaining at the bottom of the reactor is removed and discarded.

### **Process Trials**

On 29 December 2002, the process was trialed at the Al Kindi Company in the presence of representative from the Republican Guard Artillery Trials and Acceptance Section. 5 cylinders were filled to a pressure of 50 Bar. The hydrogen was used to inflate and deploy a meteorological balloon (volume 2.5-3.3m<sup>3</sup>) loaded with radio and radar deflection equipment. The process was signed off and handed over on 11/3/2003.

### **Cost**

250 million Iraqi Dinars for each trailer.

### **Notes on the Process**

[Several points were noted by the Republican Guard in connection with the suitability of the process for its stated use.]

- The process is not considered a true "field" system because it is not rugged enough and is both large and heavy.
- The gauges require external protection (operator safety).
- All pressure and temperature gauge connector stubs need to be shortened, protected, and insulated.
- A smaller capacity plant might be more compatible with the needs of the Met Sections of those forces that need to be self-sufficient in hydrogen.
- The target purity for the hydrogen product is 99.9% if the performance characteristics of the balloons are to be achieved. This purity cannot be guaranteed and therefore balloon performance is compromised,

- Clear operating instructions to be displayed on the trailer,
- Trailer needs to be lightly armored (shrapnel proof),
- 2 x powder fire extinguishers are required (6kg total),
- It would be possible to make a smaller version (enhanced mobility)—if the various pieces of equipment needed could be procured.

### **Evaluation of the Documents Pertaining to the Trailers Recovered from the Al Kindi General Establishment**

#### **Summary**

Al Kindi and the Republican Guard Command signed a contract on 23 June 2001 under which Al Kindi would produce two hydrogen generating units for what was described as weather air stations for 50,000,000 Iraqi Dinars. Work was scheduled to last 16 months from 1 July 2001 to 1 November 2002. Work went more slowly than planned. Al Kindi blamed the State Enterprise for Heavy Equipments Engineering (SEHEE) in Baghdad, the sub-contractor that fabricated the reactor vessels. There were discussions concerning the provision of towing vehicles, an item missing from the original contract. Al Kindi failed to achieve the contract completion date in November 2002, and informed the Republican Guard of a six-month delay. In December 2002, in its semi-annual declaration to the UN, Al Kindi listed the 'production station for H<sub>2</sub> gas' along with many other projects then on hand. The first of the two trailer-borne units was completed in early 2003. A joint Al Kindi and Republican Guard group tested the system on 11 March 2003. They concluded that, although the equipment produced hydrogen according to the specifications, there were many unsatisfactory features. Despite this, in late March 2003, the Military Industrial Commission (MIC) wrote to the

Republican Guard urging them to collect the completed equipment. They did not do so. Al Kindi was still assembling the second trailer when OIF started. Both trailers remained at Al Kindi at the start of OIF.

On 19 April 2003 the first trailer, with its equipment largely intact, was recovered from looters and exploited by Coalition personnel. On 11 May 2003, the second trailer was recovered from Al Kindi. It appeared to have suffered some looting. It too was exploited by Coalition personnel.

The exploitation effort included visiting Al Kindi. Managers, engineers, and scientists who had been involved in the project were debriefed. They provided copies of supporting documents. The equipment was measured, photographed, and samples taken of material within the first system.

#### **Documents**

Al Kindi provided a dozen documents and working notes. This material was translated and analyzed. For ease of understanding this material is presented as a chronology:

**23 June 2001.** Contract No. 73/MD/RG/2001 for the fabrication of 2 hydrogen generation units is issued at a total cost of 500,000,000 Iraqi Dinars. The specifications are listed.

**July 2001.** Start date of Al Kindi contract for the production of the trailers.

**5 February 2002.** Al Kindi letter to Republican Guard discussing use of small towing vehicle to pull trailers.

**15 October 2002.** Al Kindi letter to Republican Guard informing them of late running of contract.

**After 15 October 2002.** Undated chart labeled Technical Progress.

**1 November 2002.** Theoretical end date of contract—6-month extension requested.

**15 December 2002.** Al Kindi mentions the station for generating hydrogen gas for a semi-annual declaration to UNMOVIC.

**29 December 2002.** Report issued by the Command of the Republican Guard Artillery, the Branch of Examination and Acceptance of the Republican Guard and the Working Group from Al Kindi. The report reviews what has been achieved against the provisions of the contract. All the items listed conformed to the required specification. A test produced hydrogen in the capacity required. A lightning rod was in place for safety. The observations include statements that the system is not field-worthy because it is heavy and requires a towing vehicle, and it needs for protection. Al Kindi is recommended to address the necessary changes.

**8 January 2003.** Unspecified RG correspondence referred to in 23 January 2003 letter.

**22 January 2003.** Top Secret letter from MIC to Al Kindi requesting action on observations on contract.

**23 January 2003.** Letter from Republican Guard to Al Kindi with observations on the trailers.

**5 February 2003.** MIC letter to RG Artillery Commander dated 5 February 2003. The letter discusses the procurement of a towing vehicle.

**26 February 2003.** Letter from Republican Guard CoS to Republican Guard Artillery Commander discussing TS correspondence of 8 January 2003 requesting an opinion on an unspecified matter in connection with the contract.

**11 March 2003.** The day that the equipment was tested. Shortly after a signed log of the results was produced.

**23 March 2003.** MIC letter to the Artillery Command of the Republican Guard, discussing the 11 March 2003 test results for contract 73/MD/RG/2001 and requesting that the vehicle be picked up as quickly as possible.

**25 April 2003.** On 19 April 2003, Kurdistan Democratic Party (KDP) elements confiscated a tractor and trailer near a checkpoint at Tall Kayf in northern Iraq. The trailer was stolen by a looter from a truck park in northwest Mosul near an ammunition plant. Upon investigation, it was apparent that the trailer may be part of the Iraqi transportable CBW system. US forces then moved the trailer to Irbil air base for further

investigation. The gooseneck trailer has two rear axles and accommodation in the frame for a third also at the rear. A telescoping rod, which could raise roughly nine meters, was located at the rear left corner of the trailer. Roughly three to four inches of a solid light brown material beneath a one half-inch liquid layer was inside. Despite wearing protective mask, an ammonia odor was noted. The pH of the material was fourteen. A rusted hand shovel was located at the base of the reaction vessel. Color coded valves had been taped to prevent overspray during painting; masking tape had not been removed from one valve indicating that the valve had not been used since the trailer was painted.

**30 April 2003.** Information from a technical evaluation and intrusive examination by coalition personnel of the equipment and piping system resulted in a flow schematic consistent with batch production of biological (likely bacterial only) agents. This unit does not appear to perform any function beyond the production of biological agents.

**11 May 2003.** US forces found a second 'suspected mobile BW agent production' trailer outside Al Kindi Research, Development, Testing and Evaluation Center in Mosul. The trailer was partially assembled, lacking many components. Design and components were nearly identical to previously exploited 'suspect BW production' trailer. US forces located the trailer outside the main gate of Al Kindi (36°24'09.5"N 043°08'04.9"E) in a parking lot approximately 100m west of the center main gate and within 75m of the administration offices. The trailer was a dual axle flat bed with welded steel caging for walls and roof. The top caging (roof) of the trailer had been displaced in two areas. The cage above the water reservoir had been unbolted on one side and bent down to eye level. The cage above the compressor housing had been unbolted on both sides and placed on the decking of the trailer. Various components were installed or present on the trailer. From front to back, there are a water chiller with four fan housings, a motor, a large stainless steel water reservoir, a small stainless steel tank on three legs, the main stainless steel reactor, a compressor housing with compressor, and the compressor motor. Some of connections (piping) were in place

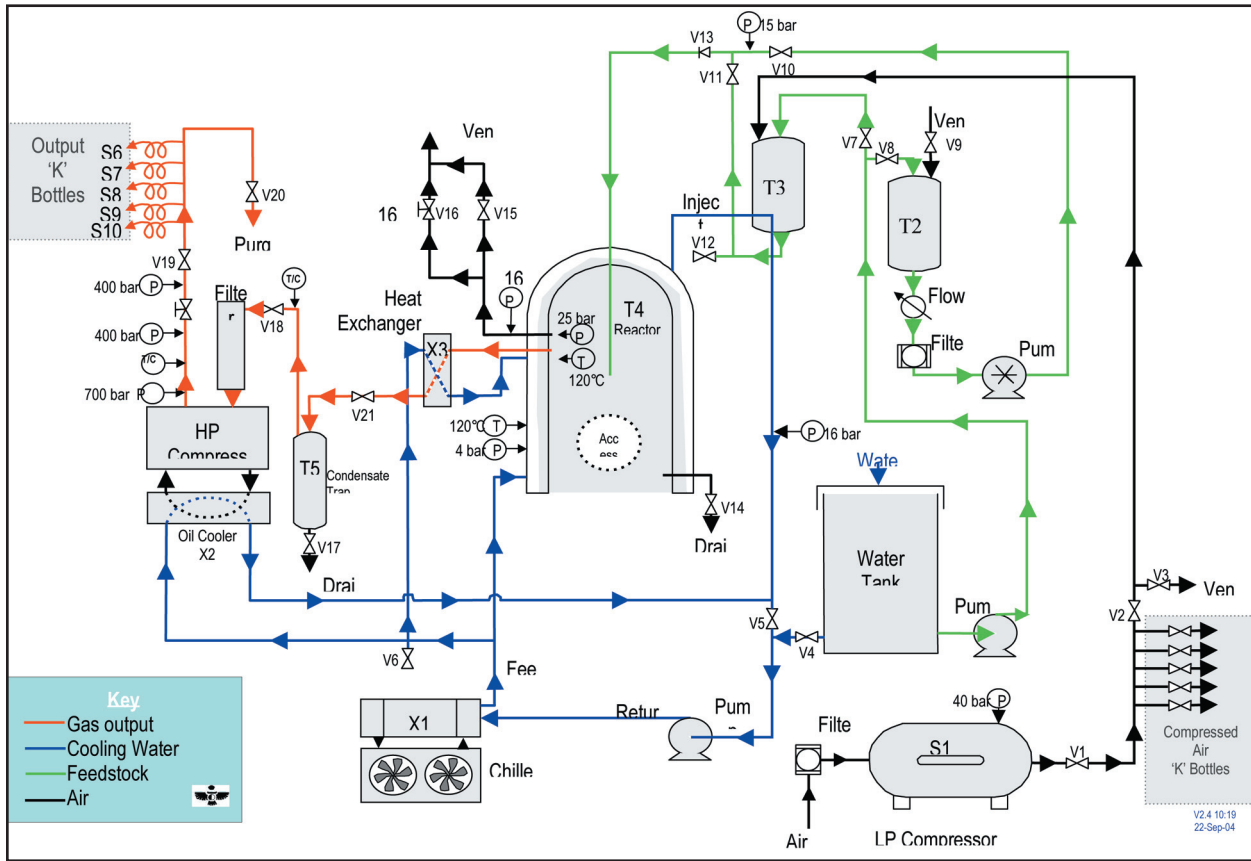


Figure 9. Process flow diagram of trailer process.

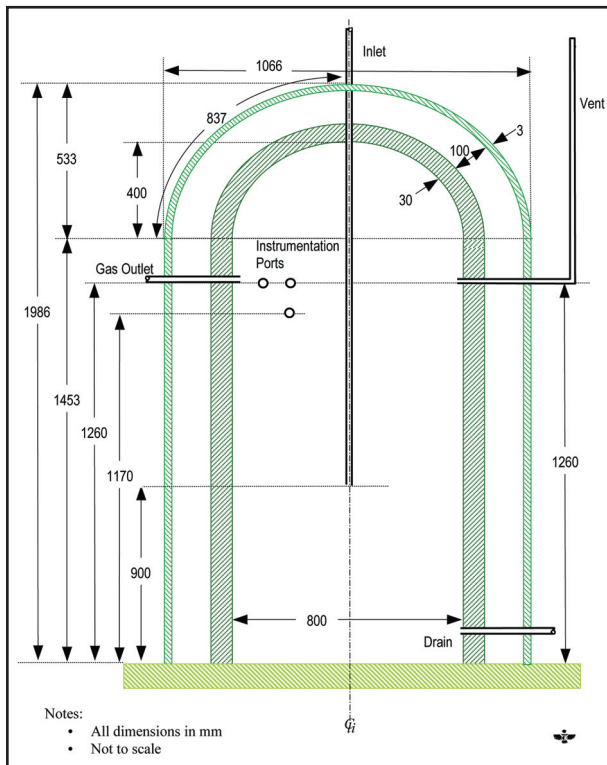


Figure 10. Diagram of reactor.

between components and others ended abruptly. No wiring or other electrical components were present. A number of attachment brackets were located on the decking of the trailer. The trailer appears to be a previously used armor or heavy equipment transporter. Overall layout of this trailer was very similar to the mobile trailer previously reported. The underside of the trailer had been recently painted and showed neither signs of wear nor any dirt or road debris. The trailer was found without tires and had been placed on concrete blocks.

**12 May 2003.** Between October 2001 and February 2003, the State Establishment for Heavy Equipments Engineering (SEHEE) fabricated two reactors, under requirements generated by the MIC. The first reactor was delivered in July 2002 to the Al Kindi State Establishment in Mosul. A modified second reactor was delivered to the same customer in January 2003. On 25 October 2001, SEHEE (Al Nasr Al Azim State Company) received a letter from MIC's Al Kindi State Establishment to fabricate two stainless steel jacketed reactors. According to the letter of request, SEHEE would receive unspecified materials from Al Kindi in Mosul. SEHEE's Ri'ad factory, building number six, received the work-order number '4/40/2001', after being processed through the company's design, technology, and planning departments. The head engineer for building number six is engineer Najm. Al Kindi dedicated engineer Mahmud Saleh as the primary coordinator on the project in an effort to emphasize the importance of the project and ensure any design or fabrication problems were quickly rectified. Mahmud Saleh visited SEHEE routinely to monitor progress and provide guidance. Reactors one and two were built using stainless steel 316 in the fabrication of both the inner and outer shells. When source asked how the first reactor performed, the Al Kindi representative indicated the reactor was 'successful.' According to the source, the first reactor was only hydrostatically tested, because reactor one's manhole diameter was too narrow for radiography equipment. During the initial hydrostatic test, reactor one was designed to withstand 100 bar. Because the source could not verify welds of reactor one with radiography, the Ri'ad factory was limited to hydrostatically testing the reactor one to 10 bar. When this was explained, Mahmud Saleh stated a 10

bar test would be sufficient, because the vessel would only contain 'hydrogen'. Subsequently, reactor two's manhole was widened to the diameter of 14 inches to allow for radiography of interior welds.

**12 May 2003.** Preliminary analysis of samples from the suspect transportable biological production trailer reveals negative results for chemical and biological agent signatures. An analysis with hand held assays and polymerase chain reaction (PCR) was conducted on 7 May 2003 to determine the presence of the following BW agents: anthrax, plague, Ricin, botulinum toxin, SEB, tularaemia, Brucella, and smallpox. No positive results for any BW pathogens or toxins were noted. Chemical analysis of three samples from this exploitation was conducted by the CBIST chemical laboratory using gas chromatography, mass spectrophotometry (GCMS). All samples were negative for chemical warfare agents within the detection limits of the analytical instrument (1 nanogram per microlitre).

**17 May 2003.** The designer of the trailers explained that the equipment was for hydrogen generation.

**4 June 2003.** Cover letter from DG Al Kindi to American Authority in Mosul, dated 4 June 2003, entitled '*Mobile Hydrogen Field Production System.*' The letter mentions the customer as the Republican Guard, Artillery Corps (Contract No. 73/Art/RG/2001), who required two trailers to produce hydrogen gas for meteorological station purposes. The letter also mentions the declaration to UNMOVIC of the equipment on 15 December 2002. Al Kindi offers to demonstrate the use of the equipment to generate hydrogen. The documents attached are:

- List of 10 personnel who worked on the project (5 engineers, 1 chemist and 3 technical observers).
- Technical report of 15pp on the hydrogen generators, produced in week 1 June 2003. MIC TS letter to Al Kindi dated 22 January 2003.
- Letter from Republican Guard HQ to Al Kindi 23 January 2003.
- Undated chart labeled Technical Progress.
- Project report given to UNMOVIC, dated 15 December 2002.

- Undated Republican Guard Report to Al Kindi about the tests.
- Copy of contract no. 73/MD/RG/2001 dated 23 June 2001.
- Al Kindi letter to Republican Guard discussing use of small towing vehicle, dated 5 February 2002.
- Letter from Republican Guard COS to Republican Guard Artillery Commander discussing TS correspondence of 8 January 2003 requesting an opinion on an unspecified matter in connection with the contract. Letter dated 26 February 2003.
- MIC letter to the Artillery Command of Republic Guard discussing the 11 March 2003 test results, dated March 2003 .
- Information letter, handwritten in Arabic, log of test results on 11 March 2003 with recommendations .

**15 June 2003.** Three sources from Al Kindi provide details of reactants and miscellaneous technical points.

**Models and Military Use.** The hydrogen trailer production system was modeled after the previously-used version of a mobile hydrogen gas generator, that produced hydrogen gas that was fed directly in to weather balloons without being condensed into cylinders. The model was the older hydrogen production unit that originated from Russian technology. The mobile hydrogen generation system was used instead of transporting gas cylinders into the field because it was practical and economical to produce hydrogen on site for the military. The use of the mobile unit alleviated the logistical concerns of transporting the hydrogen to the field. The system was large and heavy because it was developed and used by the Iraqi military. That is, it was designed to be durable and easily operated. No other methods of producing hydrogen gas were investigated. The trailers were modeled on a simpler version that directly produced hydrogen without condensation of the gas into cylinders. The sources did not request any outside assistance from either foreign or other Iraqi facilities for the design or manufacture of the mobile hydrogen production system.

**Chemical Reaction.** The production of hydrogen from aluminum, sodium hydroxide, and water was a reliable method that was previously used by the militaries in Iraq, Russia, and other countries. There were two methods in which water could enter the reactor. The first was via an air pressure system and the second was a direct feed method. Thus, the air was used only to push the water into the reactor, and it would not enter it. The water was not purified or filtered prior to use in the system.

**Design.** The reactor was designed specifically for the hydrogen production system. Specifically, the reactor was designed by the senior engineer and technical assistant to the director in late 2001. The reactor was constructed of stainless steel to prevent corrosion. Inlets and outlets for the various gases and liquids in the reactor were placed in accordance with the most practical locations. The reactor jacket was designed to operate in an even cooling layer to uniformly reduce the temperature within the reactor. The equipment was arrayed on the trailer in the most practical manner to ensure its effectiveness.

**Products.** The hydrogen was transferred from the reactor via the pipe in the top of the vessel. The two at the top are supply pipes, the one on the upper back goes to the compressor. The hydrogen it entered a filter to remove residual water and particulates, and then was compressed into the cylinders.

**Safety.** Safety precautions were developed during the production and handling of hydrogen. An oil-free compressor was placed on the trailer to compress the hydrogen as it was produced. The system was grounded to prevent any accidental ignition of the gas. In addition to a metal ground stake, a metal pole was attached to the trailer to act as a lightning rod to prevent sparks.

**Financial Aspects.** The equipment was purchased under normal purchase protocol. The reactor and low-loader were the most expensive pieces of equipment. Components were selected and purchased based on their availability in the open Iraqi market. Improvised equipment, such as the use of oxygen or nitrogen cylinders, was used instead of more difficult-to-obtain parts.

**Materials.** The reactant materials, including the aluminum powder and sodium hydroxide were obtained from the Iraqi market and were stored at Al Kindi. The trailers were designed to operate for several runs before cleaning, and the by-products were to be removed by scooping out the residual solids and running water through the reactor for cleaning. The hardest piece of equipment to acquire was the reactor. The delay in delivery from the production company caused the contract to be delayed for six months.

**Operation.** The equipment was operated based on the logical design developed by the sources. The system was to be powered by one of two methods. The first method involved the direct use of an electric source and the second method was to use a generator. The generator could be towed or located nearby the trailer, in a location that would not cause potential ignition of the hydrogen.

**Transportation of the Trailers.** The chassis (low loader) was used to support the weight of the equipment, and because it was readily available in the market. The system was to be pulled with a standard cab. The trailers were never moved to the test site. The cylinders containing the hydrogen produced on the trailers were the only item(s) taken to the test site. The hydrogen was used to fill meteorological weather balloons at the test site. The sources last saw both trailers at Al Kindi. The first trailer was complete and ready for delivery, and the second trailer was incomplete. The source alerted the Republican Guard to quickly come and get the complete trailer from Al Kindi, but they were never taken from Al Kindi prior to or during the war. Thus, no one used the trailers during the war.



**Figure 11.** Scoop for solids.



## Glossary and Acronyms

<b>Term or Acronym</b>	<b>Meaning or Definition</b>
28th April Group	A research group paralleling the work of the 404 Group.
404 Group	A four-man air defense missile system research group.
AAM	Air-to-Air Missile.
ABD	Airborne Division (US).
ABS	The Scientific Bureau for Drug Information and Medical Appliances.
ADDP	Accelerated Device Development Program.
ADN	Ammonium Dinitrate.
ADN	Ammonium Dinitramide (a solid-propellant oxidizer).
AEST	Albostangy Equipment Services and Trade.
Agent "A"	Botulinum toxin.
Agent "B"	Anthrax.
Agent "C"	Aflatoxin.
Agent "D"	Wheat cover smut.
Agent "G"	Gas gangrene.
AHCV	Acute Hemorrhagic Conjunctivitis.
AHF	Anhydrous Hydrogen Fluoride.
AK-20	A liquid-propellant oxidizer (IRFNA containing 20% N <sub>2</sub> O <sub>4</sub> by weight) used in SA-2.
AK-27	A liquid-propellant oxidizer (IRFNA containing 27% N <sub>2</sub> O <sub>4</sub> by weight) used in SCUD.
Al Husayn Project	Project under Husayn Kamil to identify the steps required to develop a nuclear weapon.
AlNiCo	Aluminum-Nickel-Cobalt.
Anthrax	A disease caused by the bacterium Bacillus Anthracis.
AP	Ammonium Perchlorate (a solid-propellant oxidizer).
ARADET	Arab Company for Detergent Chemicals.
ASB	Arab Scientific Bureau.
ASP	Ammunition Supply Point.
ASVI	Ameriyah Sera and Vaccine Institute.
ATAP	Anti-Tank Anti-Personnel submunitions.
ATCC	American Type Culture Collection.

ATGM	Anti-Tank Guided Missile.
AVLIS	Atomic Vapor Laser Isotope Separation.
AWACS	Airborne Warning and Control System.
AWRC	Agriculture Water Resource Center.
AYC	Akashat Yellowcake.
AZ-11	A liquid rocket fuel, composed of 2 components (89% DETA plus 11% UDMH).
Bacillus Anthracis	Causative agent of the disease anthrax.
Bacillus subtilis	Simulant for BW spore agents.
Bacillus thuringiensis	Natural bacterial insecticide and simulant for anthrax.
Bbl/d; bpd	Barrels per day.
BCP	Border Control Checkpoint.
BIAP	Baghdad International Airport.
BME	Belmetalenergo.
BOP	Balance of Payments.
Botulinum toxin	A toxin used as a BW agent.
Breakout capability	Knowledge, infrastructure, and materiel, which usually lie beneath the threshold of suspicion, but which can be rapidly adapted or reorganized to allow for weaponization processes to be undertaken. Such capabilities require pre-disposed resources and often employ dual-use technology, equipment, or knowledge.
Bt	Bacillus thuringiensis.
BW	Biological Weapon—an item of materiel that disperses or disseminates a biological agent including arthropod vectors; Biological Warfare.
CA	Commercial Attache.
CAD	Computer-Aided Design.
CAEC	Abrasive Import and Export Corporation.
CAFCD	Currently Accurate, Full, and Complete Declaration. The declaration presented to the UN by Iraq, as required by UN Resolution 1441. The 12,000-page document was presented to the UN on 7 December 2002.
CAM	Computer-Aided Manufacturing.
CBI	Central Bank of Iraq.
CBJ	Central Bank of Jordan.
CBS	Central Bank of Syria.
CBW	Chemical and Biological Weapons.
CCD	Charge Coupled Device.

CCHF	Crimean Congo Hemorrhagic Fever.
CDB	Cast Double Base (a solid-propellant, cast and then cured).
CDG	Chemical Destruction Group, a UN body operating in Iraq from 1992 to 1994.
CEAP	Captured Enemy Ammunition Point.
CEDC	Chemical Engineering and Design Center.
CENTCOM	Central Command, (US).
CEP	Circular Error Probable.
CERC	Central Evaluation Research Committee.
CGMS	Control and Guidance Missile System.
CIA	Central Intelligence Agency (US).
CIC	Chemical Industries Committee.
CIF	Company for Industrial Forests.
CJTF-7	Combined Joint Task Force 7.
Cl	Chlorine.
Clostridium botulinum	Causative agent of the disease botulism.
Clostridium perfringens	Causative agent of gas gangrene.
CMPC-B	Combined Media-Processing Center, Baghdad.
CNC	Computer Numeric Controlled devices or machines.
CNEC	Commissao Nacional de Energia Nuclear, (Brazil).
CO <sub>2</sub> Laser	Carbon Dioxide; common laser medium useful for LIS.
CoM	Council of Ministers.
CoS	Chief of Staff.
CoSm	Cobalt-Samarium.
CP	Command Post.
CPA	Coalition Provisional Authority.
CPHL	Central Public Health Laboratory, Baghdad.
CPMIEC	China Precision Machinery Import and Export Corporation.
CPU	Central Processing Unit.
CS	Tear gas (not a nerve agent).
CSL	Corn Steep Liquor.
CVL	Copper Vapor Laser; useful for LIS.
CW	Chemical Weapon—an item of materiel that disperses or disseminates a chemical agent; Chemical Warfare.
D4	N-Dimethylphosphoramidic Dichloride.
DB	Double Base, a solid propellant comprising nitrocellulose and nitroglycerine.
DCC	Dicylohexyl carbodimide.

Delivery System	The means of delivering or transporting conventional or unconventional weapons in the form of weapons platforms, such as rockets, missiles, spray devices, unmanned aerial vehicles, or other types of vehicle. Delivery is defined as the positioning of the weapon to a point from which it was designed to operate independently.
DETA	Diethylenetriamine—one of the two components of AZ-11 liquid rocket fuel.
DF	Deuterium fluoride.
DG	Director General.
DGMI	Directorate of General Military Intelligence.
DGS	Directorate of General Security.
Dhafir Project	High-explosives development program to support nuclear weapons development.
DIA	Defense Intelligence Agency (US).
DIO	Defence Intelligence Organisation (AUS).
DIS	Defence Intelligence Staff (UK).
Diwan	The Presidential Office.
DMA	Di Methyl Amine (a precursor for UDMH).
DMI	Directorate of Military Intelligence.
DMMP	Dimethyl methyl phosphonate.
DOCEX	Document Exploitation.
DOZ	Dioctyl Azelate.
DPRK	Democratic People's Republic of Korea.
Dual Use	Technology, materials, equipment, or knowledge capable of use for both legitimate and proscribed purposes. The object per se is not one or the other—it is dependent on intentions.
ECCM	Electronic Counter-Countermeasure.
ECM	Electro-Chemical Machining.
ECM	Electronic Countermeasures.
EDB	Extruded Double Base.
EDC	Engineering Design Center—MIC organization (Formerly Office 3000 Group 1, and later EDD).
EDD	Engineering Design Directorate—a MIC organization renamed the Engineering Design Center in 1988.
EEDDC	Electrical Engineering Design Center.
EGC	Electri-Gaz-Com.
EMIS	Electromagnetic Isotope Separation.

End User	The identity that is declared to be the final consumer of an exported technology, item, service, material, training, or apparatus. The entity is not necessarily the purchaser.
EOD	Explosive Ordnance Disposal.
EP	Entry Points.
ETGC	External Technology General Corporation.
EU	European Union.
EUC	End-User Certificate. An end-user certificate is an internationally recognized, but not internationally standardized, documentary method of declaring the end user of any of the above. The end-user certificate is not a foolproof system and has been frequently abused. Due to corrupt practices and outright fraud, end-user certificates can be completely false or deliberately deceptive in their declarations of the end user.
EW	Electronic Warfare.
FAE	Fuel Air Explosive.
FAO	Food and Agriculture Organization.
FASP	Field Ammunition Supply Points.
FCDC	Foreign Currency Disbursement Committee.
FEAL	Food Examination and Analysis Lab.
FFCD	Full, Final, and Complete Disclosure. The series of Declarations Iraq presented to the UN, detailing its WMD programs. Separate documents were submitted for CW, BW, nuclear, and ballistic missiles.
Fissile material	Material (e.g., uranium) capable of undergoing nuclear fission.
FMD	Foot and Mouth Disease.
FMDV	Foot and Mouth Disease Vaccine.
FOG	Fiber-Optic Gyroscope.
FRJE	Factory for Repair of Jet Engines.
FROG-7	Free Rocket Over Ground (Mk 7). A battlefield artillery Rocket (also known as LUNA).
Front Company	A firm or commercial enterprise purposefully established and owned by Iraqi procurement authorities to purchase or otherwise illicitly acquire items prohibited by UN sanctions. The front company would operate in a covert and clandestine fashion with the intention of avoiding international scrutiny and deceiving any monitoring authorities concerning the nature of goods procured, the source of goods, the transport routes used for importation, the financial aspects of illicit trade, and the eventual Iraqi end use and end user.
FRY	Federal Republic of Yugoslavia.
FS	Fedayeen Saddam.

FSU	Former Soviet Union.
G&C	Guidance and Control.
GA	Tabuna—chemical agent.
GB	Sarina—chemical agent.
GCHQ	Government Communications Headquarters (UK).
GDP	Gross Domestic Product.
GE	General Establishment.
GEBRC	Genetic Engineering and Biotechnology Research Council/Center.
GEET	General Establishment for Engineering Technologies.
GF	Cyclosarin—a chemical agent.
GID	General Intelligence Directorate (Jordan).
GPS	Global Positioning System.
GRL	Goods Review List.
Group 1	Office 3000 group whose focus was gaseous diffusion and later gas centrifuge; later separated from Office 3000 and renamed EDD, and then EDC under MIC and MIMI.
Group 2	Office 3000/PC3 group whose focus was EMIS; later part of PC3 under MIMI.
Group 3	Office 3000/PC3 group whose focus was support activities, to include planning, purchasing, administration, technical and fabrication; later part of PC3 under MIMI.
Group 4	Originally al Husayn project; renamed Group 4 when transferred to Office 3000; later part of PC3 under MIMI.
GSE	Ground Support Equipment.
GSSE	Geological Survey State Enterprise.
HC	Higher Committee.
HDI	Human Development Index.
HE	High Explosive.
HEU	Highly Enriched Uranium—a term indicating a high percentage (>80%) of U235 isotope; generally weapons-grade material.
HF	High Frequency; Hydrogen Fluoride.
HIC	Higher Inspection Committee.
High-Value Detainee	A detainee who, due to his or her senior position in the military, security, scientific/technical, or governmental structures of Saddam Husayn's Regime, may have knowledge or insights of relevance to ISG's mission.
HP	Al Husayn Project.
HSBS	Hong Kong Shanghi Banking Corporation.

HTPB	Hydroxyl Terminated Polybutadiene (a polymeric solid-propellant binder).
HUMINT	Human Intelligence.
HVD	High-Value Detainee.
IAEA	International Atomic Energy Agency—the UN’s nuclear watchdog organization.
IAEC	Iraqi Atomic Energy Commission.
IAF	Iraqi Armed Forces.
IAH	Ibn al Haytham-Haitham (Khadimiyah).
IAH-AHI	Ibn al-Haitham—Al-Hazen Institute (located at Salman Pak).
IC	Industrial Committee.
ICC	Iraqi Chemical Corps.
ID	Iraqi Dinar.
IED	Improvised Explosive Device.
IID	International Industrial Development.
IIP	Ion Implementation Project.
IIS	Iraqi Intelligence Service.
IIS Section one	IIS internal section responsible for creating front companies in Iraq and facilitating trade with these companies.
ILTC	Iraqi Land Transportation Company.
IMF	International Monetary Fund.
IMU	Inertial Measurement Unit.
INOC	Iraq National Oil Company.
INP	Iraqi Nuclear Program.
INS	Inertial Navigation System.
Intellectual capital	A cadre with engineering and scientific knowledge.
INVO	Iraq Nuclear Verification Office.
IRFNA	Inhibited Red Fuming Nitric Acid (a liquid rocket oxidizer comprising nitric acid plus N <sub>2</sub> O <sub>4</sub> ).
ISG	Iraq Survey Group. The organization stood up by the Coalition in June 2003 to conduct a survey of Iraq’s WMD programs and to locate Captain Speicher. It is a multiagency intelligence collection and analysis organization, formed of military and civilian personnel from the United States, United Kingdom, and Australia. Its mission is to organize, direct, and apply capabilities and expertise in Iraq to discover, take custody of, and exploit information and material of intelligence value on individuals, records, WMD samples, weapons systems materials, facilities, networks, and operations.
JARIC	Joint Air Reconnaissance Intelligence Centre (UK).

JD	Joint Delegation.
JIICA	Jordan International for Industrial and Commercial Agencies.
KDP	Kurdish Democratic Party.
KGB	Komitet Gosudarstvennoy Bezopasnosti.
KIMADIA	State Company for Drugs and Medical Appliances Marketing.
KOMID	North Korea's Korea Mining Development Corporation.
LACM	Land Attack Cruise Missile.
LAMA	Active Metallurgy Testing Laboratory, Tuwaitha.
L/D	Length/Diameter ratio (of missiles).
LDM	Large Diameter Missile.
LEU	Low Enriched Uranium—a term designating uranium with a low (<5%) percentage of U235 isotope.
LIS	Laser Isotope Separation—a uranium enrichment technique using lasers for isotopic separation.
LRBM	Long-Range Ballistic Missile.
LSM	Land-to-Sea Missile.
LU	Launcher Units.
M1	Office of the Director, IIS.
M2	Directorate of Administration and Accounting, IIS.
M3	Directorate of Data Processing and Information Security, IIS.
M4	Directorate of Foreign Clandestine Operations, IIS.
M4/8	Formerly M19 of the IIS, formed of three sections: the internal, foreign, and trading sections.
M5	Directorate of Counterintelligence, IIS.
M6	Directorate of Internal Security, IIS.
M7	Directorate of Investigation and Prosecution, IIS.
M8	Directorate of Liberation Movements, IIS.
M9	Directorate of Communications, IIS.
M10	Directorate of Studies and Research, IIS.
M11	Training and Preparation Institute, IIS.
M12	Directorate of Accounting, IIS.
M13	Directorate of Clandestine Operations, IIS.
M14	Directorate of Special Operations, IIS.
M15	Directorate of Legal Affairs, IIS.
M16	Chemical Preparations Division, IIS.
M17	Directorate of Signals Intelligence, IIS.



M18	Directorate of Residency, IIS.
M19	The primary IIS body handling procurement of specialized items. Redesignated as M4/8 also known as the Technical Consultation Company or the Trade Office.
M20	Directorate of Surveillance, IIS.
M21	The Al Ghafiqi Project, responsible for explosives in IIS.
M22	Directorate of Protective Services, IIS.
M23	Directorate of MIC Security, IIS.
M40	Directorate of Opposition group activities, IIS.
MABOT	Mina al Bakr Offshore Terminal.
MANPADS	Man Portable Air Defense Systems.
MAPO	Tris-1-(2-Methyl) AziridinyI Phosphine Oxide.
MEASI	Middle East Advanced Semi-Conductors ,Inc.
MEK	Mujahiddin e Khaliq.
MFA	Ministry of Foreign Affairs.
MGRS	Mercator Grid Reference System.
MHESR	Ministry of Higher Education and Scientific Research.
MIC	Military Industrialization Commission.
MIM	Ministry of Industry and Minerals.
MIMI	Ministry of Industry and Military Industrialization.
MIO	Military Industrial Organization—also known as MIC.
MGM	Modified G Medium.
MLIS	Molecular Laser Isotope Separation.
MoA	Ministry of Agriculture.
MoD	Ministry of Defense.
MoF	Ministry of Finance.
MoH	Ministry of Health.
MoO	Ministry of Oil.
MoT	Ministry of Trade.
MoTC	Ministry of Transport and Communication.
MOU	Memorandum of Understanding.
MOST	Ministry of Science and Technology.
MPC	Methylphosphonyl Chloride.
MPF	Methylphosphonyl Difluoride.
MPS	Methylphosphonothioic Dichloride.
MRDC	Military Research and Development Center.

MRL	Multiple Rocket Launcher.
MS	Main Survey.
MSE	Muthanna State Establishment—an organization within the MIC.
MTC	Military Technical College.
MTCR	Missile Technology Control Regime.
N2O4	Nitrogen Tetroxide.
Nd-YAG	Neodymium doped yttrium aluminum garnet—a laser medium.
Nd-Glass	Neodymium doped glass—a laser medium.
NFI	No Further Information.
NGA	National Geospatial Intelligence Center (US), formerly NIMA.
NMC	National Mobilization Committee.
NMD	National Monitoring Directorate.
NMG	Nuclear Monitoring Group (IAEA).
NORINCO	North Industries Corporation.
NP	Nitronium Perchlorate (a solid-propellant oxidizer).
NPPP	National Project for Pharmaceuticals and Pesticides.
NPT	Non-Proliferation Treaty.
NSC	National Security Council.
Nuclear Weapon	A complete assembly (i.e., implosion type, gun type, or thermonuclear type) in its intended ultimate configuration which, upon completion of the prescribed arming, fuzing, and firing sequence, is capable of producing the intended nuclear reaction and release of energy.
NVD	Night-Vision Device.
NVG	Night-Vision Goggles.
ODF	Operation Desert Fox.
ODS	Operation Desert Storm.
OIF	Operation Iraqi Freedom.
OIP	Office of the Iraq Program.
OFF	Oil for Food program.
Office 3000	Project to research uranium enrichment, known as the Office of Studies and Development until late 1982; renamed PC3 in Jan 1989 after transfer to MIMI.

Oil for Food Program	The program established by UNSCR 986 in December 1996. The scheme allowed the UN to authorize sales of Iraqi oil, with the intention of allowing the Iraqis to buy food supplies with the revenues gained. In practice, trade under the OFF process opened the door for Iraq to develop numerous kick-back and illicit money-earning schemes. A percentage of OFF money was used to finance UNMOVIC.
OMI	Organization of Military Industrialization, synonymous with the MIC, the preferred usage.
OMV	Ongoing Monitoring and Verification.
ONAREM	Office National Des Resources Minieres (Niger).
OSD	Office of Studies and Development.
PC3	Petrochemical Project 3—codename for Iraq’s clandestine nuclear research and development project under MIMI.
PC13	Phosphorus Trichloride.
POC13	Phosphorus Oxychloride.
PFD	Process Flow Diagram.
PFP	Process Flow Plan.
PID	Piping and Instrumentation Diagram.
PPD	Plant Protection Division—part of Ministry of Agriculture
PPE	Personal Protective Equipment.
PPRC	Pulse Power Research Center—renamed the al Tahadi State Establishment in 1995.
Project 144	Project for the reverse-engineering of SA-2 (later SCUD)
Protocol	Official set of rules and guidelines established by state parties to regulate activity. In this instance, it refers to a systematic code of behavior for organizing trade between Iraq and its protocol partners: Egypt, Jordan, Syria, and Turkey.
QC	Quality Control.
R50	EMIS separator with central orbit radius of 500 mm.
R60	EMIS separator with central orbit radius of 600 mm.
R100	EMIS separator with central orbit radius of 1,000 mm.
R120	EMIS separator with central orbit radius of 1,200 mm.
R&D	Research and Development.
RCC	Revolutionary Command Council.
RDC	Research and Development Committee.
RDT&E	Research, Development, Test and Evaluation.
RDX	Tetra methylene tetranitramine (an explosive).

Reconstituted Program	A term describing the restart or renewal of a program based upon and using technology, materials, equipment, and knowledge from a dormant, hidden, or previously interrupted program.
RG	Republican Guard.
RGFC	Republican Guard Forces Command.
Rhoda mine 6G	A medium for dye lasers.
Ricin	A toxin used as a BW agent, derived from the castor bean.
RLG	Ring Laser Gyro (part of an INS).
RNA	Research and News Analyzing.
RO	Reverse Osmosis.
RPG	Rocket-Propelled Grenade.
RPV	Remotely Piloted Vehicle.
RSI	Regime Strategic Intent.
SA-2	Surface-to-Air missile Mk 2 (also known as Volga).
SAFF	Safe, Arm, Fuze, and Fire—a term used in weaponry including nuclear weapons.
SAM	Surface-to-Air Missile.
SAP	Security Apparatus for the Protection of military industrialization establishments.
SCP	Single Cell Protein.
SCR	Security Council Resolution (of the United Nations).
SCVM	State Company for Veterinary Medicine.
SDH	Synchronous Digital Hierarchy.
SDI	Samarra Drug Industry.
SE	State Establishment.
SEEMO	State Establishment for Extraction and Mining Operations.
SEHEE	State Establishment for Heavy Engineering Equipments.
SEPI	State Enterprise for Petrochemical Industries.
SEPP	State Establishment for Pesticide Production.
SF	Special Forces.
SFOR	Stabilization Forces.
SIEI	Specialized Institute for Engineering Industries.
SIGINT	Signals Intelligence.
SIPRI	Stockholm International Peace Research Institute.
SISMI	Italian Intelligence and Military Security Service.
SLV	Space Launch Vehicle.

SME	Subject Matter Expert.
SOE	State Owned Enterprises.
SOMO	State Oil Marketing Organization.
SOTI	State Organization for Technical Industries.
SPO	Special Projects Office—subordinate office in MIC; also known as the Master Subjects Office.
SRBM	Short Range Ballistic Missile.
SRC	Scientific Research Center.
SRG	Special Republican Guard.
SSM	Surface-to-Surface Missile.
SSO	Special Security Organization.
STADI	Staff Training and Development Institute, Tuwaitha, (IAEC).
STRD	Scientific and Technical Research Directorate, which later became the Technical Research Center.
SVI	Sera and Vaccine Institute.
SWB	Summary of World Broadcasts.
TABRC	Tuwaitha Agriculture and Biological Research Center.
TAGCO	Trading and Agriculture General Company.
TCC	Technical Consulting Company.
TDI	Toluene DiIsocyanate (a cross-linking agent in polymers).
TEA	TriEthylAmine.
TECO	Technical Corps for Special Projects.
TEA	Triethylamine—a chemical agent precursor.
TEL	Transporter Erector Launcher.
TEMPS	SS-12 Missile—destroyed under Intermediate Nuclear Forces Treaty.
TFASP	Tactical Field Ammunition Supply Point.
TG-02 xylidene).	A liquid rocket fuel (a mixture of 50% TEA plus 50%
TIS	Thermal Imagery Sight.
TNRC	Tuwaitha Nuclear Research Center—the principal center of research and development in Iraq’s nuclear program.
TNT	Tri Nitro Toluene (an explosive).
TOSSCO	Technical Oilfield Services and Supply Company.
TPAO	Turkish Petroleum Company.
TPIC	Turkish Petroleum International Company, a TPAO Subsidiary.

Trade Intermediary	An independent commercial entity that links the consumer of products and services to other manufactures, vendors, transporters, financiers, and/or consultants or other service providers. Trade intermediaries were used by the Iraqi Regime. Some were cognizant of the illicit nature of trade and deliberately colluded with Iraq, while others were deceived by the Iraqi Regime and were innocent tools of illicit Iraqi procurement activities.
TRC	Technical Research Center.
TSMID	Technical and Scientific Materials Import Division.
TTC	Thermal Tracking Camera.
TVC	Thrust Vector Control (of rocket engines).
U	Uranium.
U#	UNSCOM inspection number.
UAE	United Arab Emirates.
UAV	Unmanned Aerial Vehicle.
UCI4	Uranium Tetrachloride.
UDMH	Unsymmetrical DiMethylUnsymmetrical Di-Methyl. Hydrazine-one. One of the two components of AZ-11, a liquid rocket fuel.
UEIE	Ur Engineering and Industrial Establishment.
UF4	Uranium Tetrafluoride.
UF6	Uranium Hexafluoride.
UGF	Underground Facility.
UHF	Ultra High Frequency.
UN	United Nations.
UNCC	United Nations Compensation Commission.
UNDP	United Nations Development Program.
UNESCO	United Nations Educational Scientific and Cultural Organization.
UNICEF	United Nations International Children's Emergency Fund.
UNGA	United Nations General Assembly.
Unilateral Destruction	Destruction of weapons, equipment, or documents by one party only.
UNMOVIC	United Nations Monitoring, Verification, and Inspection Commission. Set up by UNSCR 1284 on 17 December 1999 as a replacement for UNSCOM. Its first Executive Chairman was Dr. Hans Blix.
UNOPS	United Nations Operations.
UNSC	United Nations Security Council.
UNSCOM	United Nations Special Commission. Set up by UNSCR 687 on 3 April 1991 ". . . to carry out immediate on-site inspection of Iraq's biological, chemical, and missile capabilities." Inspections of nuclear capabilities were carried out by the UN's International Atomic Energy Agency (IAEA), and the two sometimes worked alongside each other.

UNSCR	United Nations Security Council Resolution.
UNSCR	United Nations Security Council Resolution.
UNSYG	United Nations Secretary General.
UO2	Uranium Dioxide.
UO4	Uranium Tetroxide.
UoB	University of Baghdad.
URENCO	European Enrichment.
USD	US Dollars.
USSR	Union of Soviet Socialist Republics.
UTL	United Telecommunications, Limited.
UXO	Unexploded Ordnance.
VHF	Very High Frequency.
VP	Vice President.
VR	Video Reconnaissance.
VVDP	Veterinary Vaccine and Drug Production facility.
VX	A highly toxic CW nerve agent.
Weaponization	The application of technology, materials, equipment, and knowledge to harness the effects or physical principles that have been proven in laboratory or otherwise controlled conditions to create a weapon.
WFP	World Food Program.
WHO	World Health Organization.
WMD	Weapons of Mass Destruction. Weapons that are capable of a high order of destruction and/or being used in such a manner as to kill large numbers of people. Can be nuclear, chemical, biological, or radiological weapons but excludes the means of transporting or propelling the weapons where such means are a separable and divisible part of the weapon. Chemical Weapons and Biological Weapons need to be of a certain size to count as WMD—single chemical or biological artillery rounds would <i>not</i> be considered to be WMD, due to the limited damage they could produce.
Yellowcake	A form of uranium ore concentrate.





