

THIS FILE IS MADE AVAILABLE THROUGH THE DECLASSIFICATION EFFORTS AND RESEARCH OF:

THE BLACK VAULT

THE BLACK VAULT IS THE LARGEST ONLINE FREEDOM OF INFORMATION ACT / GOVERNMENT RECORD CLEARING HOUSE IN THE WORLD. THE RESEARCH EFFORTS HERE ARE RESPONSIBLE FOR THE DECLASSIFICATION OF THOUSANDS OF DOCUMENTS THROUGHOUT THE U.S. GOVERNMENT, AND ALL CAN BE DOWNLOADED BY VISITING:

[HTTP://WWW.BLACKVAULT.COM](http://www.blackvault.com)

YOU ARE ENCOURAGED TO FORWARD THIS DOCUMENT TO YOUR FRIENDS, BUT PLEASE KEEP THIS IDENTIFYING IMAGE AT THE TOP OF THE .PDF SO OTHERS CAN DOWNLOAD MORE!

AUSCHWITZ AND ANGLO-AMERICAN AIR POWER:
HISTORICAL DEBATES AND MILITARY CAPABILITIES

by

Rondall Ravon Rice

A THESIS

Presented to the Faculty of

The Graduate College at the University of Nebraska

In Partial Fulfillment of Requirements

For the Degree of Master of Arts

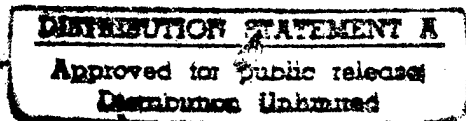

Major: History

Under the Supervision of Professor Alan E. Steinweis

Lincoln, Nebraska

December, 1996

19961223 105

DISCLAIMER NOTICE

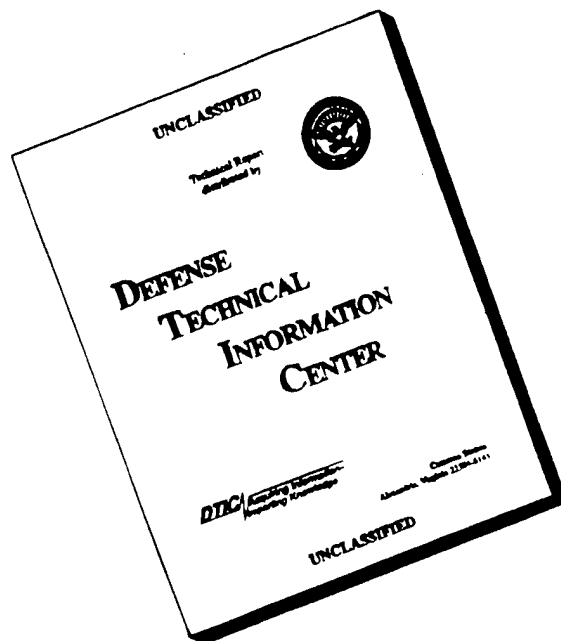

THIS DOCUMENT IS BEST QUALITY AVAILABLE. THE COPY FURNISHED TO DTIC CONTAINED A SIGNIFICANT NUMBER OF PAGES WHICH DO NOT REPRODUCE LEGIBLY.

REPORT DOCUMENTATION PAGE

Form Approved
OMB No. 0704-0188

Public reporting burden for this collection of information is estimated to average 1 hour per response, including the time for reviewing instructions, searching existing data sources, gathering and maintaining the data needed, and completing and reviewing the collection of information. Send comments regarding this burden estimate or any other aspect of this collection of information, including suggestions for reducing this burden, to Washington Headquarters Services, Directorate for Information Operations and Reports, 1215 Jefferson Davis Highway, Suite 1204, Arlington, VA 22202-4302, and to the Office of Management and Budget, Paperwork Reduction Project (0704-0188), Washington, DC 20503.

| | | | | |
|--|---|--|--|--|
| 1. AGENCY USE ONLY (Leave blank) | | 2. REPORT DATE <i>13 Dec 96</i> | 3. REPORT TYPE AND DATES COVERED | |
| 4. TITLE AND SUBTITLE <i>Auschwitz And Anglo-American Air Power: Historical Debates and Military Capabilities</i> | | | 5. FUNDING NUMBERS | |
| 6. AUTHOR(S) <i>Ronald RAYON Rice</i> | | | | |
| 7. PERFORMING ORGANIZATION NAME(S) AND ADDRESS(ES) <i>University of Nebraska</i> | | | 8. PERFORMING ORGANIZATION REPORT NUMBER <i>96-097</i> | |
| 9. SPONSORING/MONITORING AGENCY NAME(S) AND ADDRESS(ES) DEPARTMENT OF THE AIR FORCE AIR FORCE INSTITUTE OF TECHNOLOGY/CI 2950 P STREET WRIGHT-PATTERSON AFB OH 45433-7765 | | | 10. SPONSORING/MONITORING AGENCY REPORT NUMBER | |
| 11. SUPPLEMENTARY NOTES | | | | |
| 12a. DISTRIBUTION / AVAILABILITY STATEMENT <i>Unlimited</i> | | | 12b. DISTRIBUTION CODE | |
| 13. ABSTRACT (Maximum 200 words) <div style="text-align: center; font-weight: bold; transform: rotate(-90deg);">DTIC QUALITY INSPECTED</div> | | | | |
| 14. SUBJECT TERMS | | | 15. NUMBER OF PAGES <i>161</i> | |
| | | | 16. PRICE CODE | |
| 17. SECURITY CLASSIFICATION OF REPORT | 18. SECURITY CLASSIFICATION OF THIS PAGE | 19. SECURITY CLASSIFICATION OF ABSTRACT | 20. LIMITATION OF ABSTRACT | |

GENERAL INSTRUCTIONS FOR COMPLETING SF 298

The Report Documentation Page (RDP) is used in announcing and cataloging reports. It is important that this information be consistent with the rest of the report, particularly the cover and title page. Instructions for filling in each block of the form follow. It is important to *stay within the lines* to meet *optical scanning requirements*.

Block 1. Agency Use Only (Leave blank).

Block 2. Report Date. Full publication date including day, month, and year, if available (e.g. 1 Jan 88). Must cite at least the year.

Block 3. Type of Report and Dates Covered. State whether report is interim, final, etc. If applicable, enter inclusive report dates (e.g. 10 Jun 87 - 30 Jun 88).

Block 4. Title and Subtitle. A title is taken from the part of the report that provides the most meaningful and complete information. When a report is prepared in more than one volume, repeat the primary title, add volume number, and include subtitle for the specific volume. On classified documents enter the title classification in parentheses.

Block 5. Funding Numbers. To include contract and grant numbers; may include program element number(s), project number(s), task number(s), and work unit number(s). Use the following labels:

| | |
|-----------------------------|-------------------------------------|
| C - Contract | PR - Project |
| G - Grant | TA - Task |
| PE - Program Element | WU - Work Unit Accession No. |

Block 6. Author(s). Name(s) of person(s) responsible for writing the report, performing the research, or credited with the content of the report. If editor or compiler, this should follow the name(s).

Block 7. Performing Organization Name(s) and Address(es). Self-explanatory.

Block 8. Performing Organization Report Number. Enter the unique alphanumeric report number(s) assigned by the organization performing the report.

Block 9. Sponsoring/Monitoring Agency Name(s) and Address(es). Self-explanatory.

Block 10. Sponsoring/Monitoring Agency Report Number. (If known)

Block 11. Supplementary Notes. Enter information not included elsewhere such as: Prepared in cooperation with...; Trans. of...; To be published in.... When a report is revised, include a statement whether the new report supersedes or supplements the older report.

Block 12a. Distribution/Availability Statement. Denotes public availability or limitations. Cite any availability to the public. Enter additional limitations or special markings in all capitals (e.g. NOFORN, REL, ITAR).

DOD - See DoDD 5230.24, "Distribution Statements on Technical Documents."

DOE - See authorities.

NASA - See Handbook NHB 2200.2.

NTIS - Leave blank.

Block 12b. Distribution Code.

DOD - Leave blank.

DOE - Enter DOE distribution categories from the Standard Distribution for Unclassified Scientific and Technical Reports.

NASA - Leave blank.

NTIS - Leave blank.

Block 13. Abstract. Include a brief (*Maximum 200 words*) factual summary of the most significant information contained in the report.

Block 14. Subject Terms. Keywords or phrases identifying major subjects in the report.

Block 15. Number of Pages. Enter the total number of pages.

Block 16. Price Code. Enter appropriate price code (*NTIS only*).

Blocks 17. - 19. Security Classifications. Self-explanatory. Enter U.S. Security Classification in accordance with U.S. Security Regulations (i.e., UNCLASSIFIED). If form contains classified information, stamp classification on the top and bottom of the page.

Block 20. Limitation of Abstract. This block must be completed to assign a limitation to the abstract. Enter either UL (unlimited) or SAR (same as report). An entry in this block is necessary if the abstract is to be limited. If blank, the abstract is assumed to be unlimited.

CONTENTS

| | |
|--|-----|
| ACKNOWLEDGEMENTS..... | iii |
| INTRODUCTION | 1 |
| CHAPTER | |
| I. THE HISTORICAL DEBATE..... | 5 |
| II. BOMBING THE CAMP: THE MILITARY ASPECTS OF A POSSIBLE ATTACK | 70 |
| III. BOMBING ALTERNATIVES | 128 |
| CONCLUSION..... | 149 |
| BIBLIOGRAPHY | 153 |

ACKNOWLEDGEMENTS

Ten years ago, I was an Air Force Academy cadet laboring as an engineering major, and not enjoying my academic experience. During my Thirdclass (sophomore) year, I met two instructors, then Captains Roy Houchin and Mark Clodfelter, who changed my life. Both taught with such joy and enthusiasm that it caused the interest I had always had for history to turn to a love and passion for learning more. Not only did I switch academic majors, but I hoped and endeavored to some day return to the Academy as a history instructor and academic advisor to the Air Force's future officers. This thesis culminates that effort, and I will enter the Academy's classrooms still looking to their models as inspirations.

Lieutenant Colonel Mark Clodfelter remains the biggest reason I have been able to reach this point in my career. He has served as a constant role model, mentor, and friend. His advice and many kind letters of recommendation opened the door to opportunities that otherwise may have remained closed. Also, he has provided significant morale boosters in the form of taped Tarheel basketball games shipped to Saudi Arabia during the nine months of Desert Shield and Desert Storm, and during my three-year tour in Germany. Part of the thanks must also go to Donna Clodfelter for boxing and shipping them! I shall never be able to repay him for his kindness, but will try to compensate by attempting to inspire Air Force cadets as he did me and countless others.

The members of my graduate committee have helped me immensely. They provided a quality program, excellent instruction, and were always available when I requested advice. In addition, I gave Professors Edward Homze and Peter Maslowski an

outlet for teasing another North Carolina native and Academy graduate as they did 13 years earlier with Mark Clodfelter! I am especially grateful to my advisor, Professor Alan Steinweis, for his direction and counsel (not to mention his shared allegiance to Tarheel basketball). In addition to his other duties, he assisted in my gaining participation in two important seminars held by the Holocaust Education Foundation that will greatly enhance my ability to teach this difficult subject.

My time here at Nebraska has been short, and as with any military assignment, friends are made that make the parting more difficult. While all cannot be mentioned, I must thank two. C. Ed Wood eased the transition into graduate school with good advice over a cold beverage. Dave Snyder, one of the most dedicated students and hardest workers I have ever seen, became a sounding-board I learned much from and a trusted friend.

I must also thank my family. From my earliest days, my parents always stressed academics. I remember my father telling me, "get as much education that you can, because once you have it, nobody can take it away from you." Their love and support throughout my Academy days and Air Force career has constantly inspired me to strive for even higher heights. My brother, Johnny, has continually given me down-home advise and reminds me of my roots, no matter how far from home I get. I dedicate this work to them.

I reserve the highest accolades for my wife, Annette. She has followed me around the world, always supported my career decisions, and held-down the homefront when contingencies and training took me away. During the past 17 months, she has been not only a great wife, but a tough editor and fair critic. During most of this time, she worked

and carried around our first child, Kathleen Virginia, and has now added “wonderful mother” to her resumé. Every time I look at my new daughter, I am reminded that I owe her more than I can ever repay.

RRR
University of Nebraska-Lincoln
December 1996

INTRODUCTION

Perhaps the hardest fact for Holocaust historians, survivors, and observers to accept remains the West's non-use of direct military force to relieve Jewish suffering. The picture of American and British bombers clouding the Third Reich's skies has provoked a particularly inviting question. Why did neither country bomb the gas chambers and crematoria at Auschwitz?

The dispute itself contains many facets: government and military unwillingness to bomb these targets; bombing ability and proficiency; German ability to repair damage and continue operations; and the question of whether it was appropriate to kill Jews in order to save Jews. The final point concerns the probability that the missions themselves would have killed many Jews through stray bombs and inaccurate bombing. Attempting to settle these issues has occupied many writers since the 1960s. Historians, journalists, and others have expressed opinions, laid blame, and analyzed military and governmental efforts and capabilities.

Why Auschwitz? Of the six Nazi extermination camps, only it remained in operation after mid-July 1944. Before that date, bombing could not have occurred due to the intelligence shortfalls. Belzec, Sobibor, and Treblinka, were all dismantled by the fall of 1943. Majdanek had ceased gassing operations by the fall of 1943, and the Germans had evacuated the camp in July 1944. Chelmno was used for gassing operations until March 1943, and the Germans used it again for killing operations between June and mid-July 1944 to facilitate the Lodz ghetto liquidation. After mid-July, Jews from the ghetto

were deported to Birkenau.¹ In addition, the debate centers on Auschwitz due to its location. Being the farthest southwest, only it came within range of bombing aircraft. The proximity to a major oil target, the I.G. Farben facilities, also caused the area to be photographed several times by reconnaissance aircraft.

The following study does not attempt to blame or absolve any person or organization for not bombing Auschwitz. It will first analyze the historical debate, then offer evidence as to the possibility of using the American Fifteenth Air Force (15th AF), the most likely strategic force to carry out any bombing mission. The final chapter examines alternatives to 15th AF's heavy bombers, and the possibility of attacking railroad lines to halt the German transportation of Jews to Auschwitz.

The first chapter provides not only background for the study's subsequent chapters, but is used to sketch out the political background. Both the American and British governments received bombing requests from Jewish agencies, and both nation's leaders expressed an interest in saving innocent civilians from German persecution. American President Franklin D. Roosevelt created the War Refugee Board to aid those distressed by Hitler's actions, and British Prime Minister Winston S. Churchill expressed a desire to aid Jews to his Foreign Secretary. The decisions made by both leaders' staffs provide an important context to understanding why military rescue efforts did not occur.

When discussing a possible bombing mission, 15th AF receives the most attention, primarily because its bombers could reach Upper Silesia from their Italian bases. The distance from England eliminated using Eighth Air Force. Range also eliminated the Royal Air Force's Bomber Command, especially considering that the Combined Bomber

¹ Martin Gilbert, Atlas of the Holocaust (New York: Pergamon Press, 1988), pp. 82-102.

Offensive's division of effort made it the night-bomber force. However, when analyzing Fifteenth for mission possibilities, past authors have either simplified or over-complicated the command's abilities and German defenses facing them.

The simplification involved merely looking at a map and drawing conclusions. Some authors believed that since Fifteenth's bombers could reach the target, and had bombed oil targets around Auschwitz, they could easily have bombed the crematoria. Reducing the facts to such a simplistic level does not take into account bombing accuracy. World War II heavy and medium bombers did not achieve "precision" in the way it is understood today. For the most part, they saturated target complexes with explosives to achieve their goals. Clearly, such bombardment methods could not be employed against Auschwitz. The likely outcome would have been the camp's decimation, and the death of many Jews who survived the ordeal and lived to tell and educate the world about such horrors.

On the other hand, defenders of military inaction have endeavored to make any attack seem impossible. They overstate the effectiveness of German defenses and exaggerate the bombers' inaccuracy. To make their point, these authors have often used general statistics and average World War II capabilities. They try to show how any attack would have reduced the camp to rubble, and would have been costly to the Allies in terms of men and aircraft.

To offer a more realistic picture, this study will analyze the situation as it existed in mid-1944, and requires assuming an overriding political will as being present. In addition, the level of intelligence known, and what further information was needed, must be taken into account. These will show that no attack could have been mounted before

July 1944. Furthermore, due to the approaching winter weather, any attempt after October 1944 would have been very risky with regard to the likelihood of Jewish deaths by Allied bombs. The second chapter will investigate the intelligence time-line and information flow, Fifteenth Air Force's capabilities and historical performance record, specific bombing accuracy statistics, and German defenses during these specific months.

While Fifteenth Air Force represented the most visible asset, other bombing alternatives beg consideration. The U. S. Twelfth Air Force, also stationed in the Mediterranean theater, used heavy bombers and fighter-bombers to support ground troops in Italy and later southern France. Of their assets, only the North American B-25 Mitchell could make the trip with any chance of reasonable bomb-load and accuracy. However, the tactical considerations of depriving ground forces of necessary air support virtually excluded any chance of their use.

The British D. H. 98 Mosquito represented the most promising solution to achieving the desired goal, while also minimizing the probability of killing prisoners. One of the war's most remarkable aircraft, the bomber versions regularly attacked pinpoint targets with an accuracy unsurpassed during the war. In addition, the British had demonstrated their willingness to use the Mosquito to attack non-military targets that required extreme precision. During 1944 alone, D. H. 98 units attacked four targets in occupied Europe to aid civilians. These four attacks, and two others like them in 1943 and 1945, demonstrated the Mosquito's ability to achieve its mission with manageable losses and an ability to avoid or minimize damage to civilian non-combatants.

With the proper political backing, bombing Auschwitz was not only possible, it was achievable.

CHAPTER 1

THE HISTORICAL DEBATE

The maturation of Holocaust historiography continues to develop and spawn specialized areas of study. The 1968 publication of Arthur D. Morse's While Six Million Died began to spread the responsibility for the death of millions beyond Nazi Germany. While Morse did not attribute to Allied military commanders partial responsibility for the Nazi genocide, he did allege that American authorities stood by apathetically while it happened.¹ John Morton Blum expanded slightly on Morse's theme with his 1976 book V Was for Victory.² Many scholarly and popular works since then have continued to study Allied actions, and non-actions, and how these impacted Nazi policies and the fate of the European Jews. The specific argument as to why the Americans or British did not bomb Auschwitz, or the railroad lines from Upper Silesia to Hungary, continues to occupy many historians, survivors, veterans, and Jewish groups.

Before delving into an in-depth examination of the argument itself, an understanding of the controversy's historical context is in order, and will be the subject of this chapter. To facilitate a study of the debate, this chapter divides the debate into six time periods.

¹ Arthur D. Morse, While Six Million Died: A Chronicle of American Apathy (New York: Random House, 1968), p. 383.

² John Morton Blum, V was for Victory: Politics and American Culture During World War II (New York: Harcourt Brace Javanovich, 1976), pp. 172-181.

The early period of the debate, 1960-1977, raised the question of why the Allies did not bomb the camps or railroads, but did not delve into the subject. While Herbert Druks mentioned the topic again in 1977, the debate began in earnest with David Wyman's 1978 Commentary article. Therefore, the second time period, 1977-1978, takes an in-depth look at his arguments and the immediate responses it generated. During the third period, 1979-1989, scholarship on the bombing debate, as well as popular reactions to Wyman's article, flowed at a steady pace.

The fourth period, 1990, included the first attempt to explain the technical aspects and problems involved in bombing the camp and railroads, a significant Holocaust work by Leni Yahil, and heated debates in the press. The years 1994-1995 also saw many articles published. However, this period is defined primarily by James H. Kitchens' counter-argument to David Wyman's thesis. Finally, the 1996 publication of FDR and the Holocaust reassessed the argument. Representing a maturation of the debate, this book provides interesting articles from several prominent Holocaust historians.

Due to the remainder of this study being devoted to the military aspects of the bombing argument, the historical study of the debate serves a dual purpose. In discussing each author's thesis, information on the political maneuvering and discussions during 1944 will be included. Since this topic alone occupies numerous publications, only the key figures, dates, and arguments will be included to provide the background and context for the remainder of this thesis.

1960-1977: IMPASSIONED PLEAS AND EARLY SCHOLARSHIP

Early works mentioning the controversy succeeded only in raising the question. Lacking sources for a detailed analysis, they usually only noted the Jewish requests for action, and sometimes referred to Allied non-committal to the proposals. While they questioned Allied government's non-action, none of the early authors offered documented evidence condemning the Allies nor did they analyze the military capabilities to bomb the camps.

Raul Hilberg, the preeminent Holocaust historian, began Holocaust scholarship, and his 1961 book, The Destruction of the European Jews, remains the field's most important and monumental single-volume study (a later period discusses the 1985 three-volume set). However, due to its early date, Hilberg did not obtain access to the many records later available for studying inter- and intra-governmental actions during the war. Thus, his brief mention of possible rescue efforts via bombing operations only noted Jewish requests for such actions.³

One year later, S. B. Unsrdorfer wrote an article for the Jewish Chronicle indicting the Allies for not bombing. His rationale was that watchtower guns, pointed down into the camp, could not deter bombers from attacking Auschwitz. Unsrdorfer saw only this perceived lack of anti-aircraft defenses as the impediment keeping the Allies from bombing. A former inmate himself, he believed that any attack would spur the Jews to rush the camp gates and firmly believed, "[n]o power on earth could have halted this

³ Raul Hilberg, The Destruction of the European Jews (Chicago: Quadrangle Books, 1961), pp. 543 and 549.

human stampede.”⁴ Hilberg disputed this belief, noting the precautions taken by Reichsführer SS Heinrich Himmler against such an uprising.⁵ Unsrdorfer concluded the Allies controlled the means to aid the Jews, but gave no “real thought to the Jewish tragedy.”⁶

Five years passed before another book brought the issue to the surface again. Gideon Hausner, the lawyer who prosecuted Adolf Eichmann, published Justice in Jerusalem. Still only scratching the surface, Hausner briefly identified the Jewish requests for bombing Auschwitz and the rail lines feeding it, and refusal of the British Foreign Office to do so. He did not bring up Jewish opposition to the bombing proposals. Although he did quote two prominent Royal Air Force (RAF) personnel as supporting the possibility of bombing, he pursued the idea no further. The two RAF officers, Sir Arthur Harris and Group Captain Leonard Cheshire, made their statements in 1963 and 1961, respectively.⁷

In the same year, 1967, George Steiner mentioned the bombing debate in a book devoted to language and literature, Language and Silence. Steiner asked the question, “just when did the names Belsen, Auschwitz, Treblinka first turn up in Allied intelligence files?” but does not answer the question. He does mention a possible raid by British de Havilland Mosquito bombers similar to the raid on the prison in Amiens, France (a

⁴ S. B. Unsrdorfer, “The Call that Went Unanswered,” Jewish Chronicle, 14 December 1962 as quoted in Richard H. Levy, “The Bombing of Auschwitz Revisited: A Critical Analysis,” in FDR and the Holocaust, ed. Verne W. Newton (New York: St. Martin’s Press, 1996), p. 254.

⁵ Hilberg, p. 584.

⁶ Unsrdorfer in FDR, p. 254.

⁷ Gideon Hausner, Justice in Jerusalem (London: Thomas Nelson and Sons, Ltd., 1966), pp. 243-245.

further analysis of this argument follows). Again, debate and evidence remain limited, and the author accused the Allies of not saving Jewish lives with military action.⁸

Two books appeared in 1968 that mentioned the controversy, but followed the same pattern of earlier works. First, Abba Eban's My People: The Story of the Jews offered a sweeping account of Jewish history but contained no footnotes or bibliography. Once again, the citing of the bombing issue focused mainly on Jewish requests, but he did mention that the RAF turned down the request "for technical reasons."⁹

The second, Shmuel Katz's Days of Fire, also cast doubt about the RAF's reasons for not bombing. However, Katz also begs the question of why British Prime Minister Winston Churchill "moved heaven and earth" to persuade the Allies to use airpower to aid the Warsaw uprising, with 181 sorties flown from Italian bases, but took no action against Auschwitz (Bernard Wasserstein would, in 1979, explain Churchill's actions and requested his staff to re-examine bombing Auschwitz and rail lines leading to it).¹⁰ Katz also said that Britain's wartime Chief of RAF Bomber Command, Air Chief Marshal Arthur Harris (speaking in 1961), believed the Allies could have bombed Auschwitz. Finally, Katz believed the Allies could bomb the train route from Budapest to Auschwitz. He included a rudimentary map of the route, with distances from the Allied base at Foggia, Italy annotated.¹¹

⁸ George Steiner, Language and Silence (New York: Atheneum, 1967), pp. 149-150 and 158.

⁹ Abba Eban, My People: The Story of the Jews (New York: Behrman House, Inc., 1968), pp. 425-427.

¹⁰ Shmeul Katz, Days of Fire (Garden City, New York: Doubleday & Company, Inc., 1968), p. 86.

¹¹ Ibid, map is located in illustrations between pages 54 and 55.

Henry Feingold's The Politics of Rescue became the first to target specific individuals within the U.S. government. The book represented the first complete, scholarly volume dedicated to analyzing the failure of rescue efforts within an Allied government. Feingold used materials in the State Department that, until that time, had been classified. Much like the earlier authors, he committed a very small space to the specific issue of bombing and confines his analysis to the Jewish requests and Allied inaction.¹² He concluded that mass rescue (including political and non-military actions to get Jews out of Europe) required a full and "passionate commitment" nonexistent in the administration of President Franklin D. Roosevelt.¹³ However, his condemnation did not stop with the State Department or President Roosevelt. He cited the lack of concerted effort and the presence of bitter in-fighting between Jewish groups as failing to apply steady pressure to the American government.¹⁴

Feingold did inculpate Roosevelt for not grasping tightly the reins of his power and push his administration to pursue rescue efforts. However, he did agree that any effort would have required "not only inordinate energy and will but also coordination with other nations and agencies."¹⁵ Also, the author admits that even if all of the pieces came together and a rescue effort made, no assurance of success existed, and the Nazis would have continued to murder Jews. Feingold concluded his book:

Yet within full view of the world and when the Nazi authorities could no longer doubt that they had lost the war, the cattle cars rolled to Auschwitz as if they had

¹² Henry L. Feingold, The Politics of Rescue: The Roosevelt Administration and the Holocaust, 1938-1945 (New Brunswick, N.J.: Rutgers University Press, 1970), pp. 256-257.

¹³ Ibid, p. 295.

¹⁴ Ibid, pp. 298-301.

¹⁵ Ibid, p. 305.

a momentum of their ownAppalling as it may sound, the saving of lives was a far more formidable task than the practice of genocide. Even a passionate will to save lives could prove insufficient, given Nazi determination to liquidate the Jews of Europe.¹⁶

Feingold, for the first time, took the argument beyond speculation and impassioned damnation. While proving the American government did not use all of its resources to effect a rescue, he agreed that any rescue effort would meet considerable obstacles.

The final book of this first period returned to the trend more passion than substance. Herbert Druks, in his book Failure to Rescue, offered an impassioned argument and damned the Allies for failing to save the European Jews. Druks' argument centered on Jewish organizations' efforts to push Allied governments into action on a variety of measures. These Jewish organizations included the World Jewish Congress (WJC), the Jewish Agency, and Vaad Hahatzala (Orthodox rescue committee), the Jewish Labor Committee, and the Joint Distribution Committee. Smaller groups of organized Jews (and those from the different Jewish sects) in America, Britain, and Hungary also wrote to the various Allied governments. Among these groups, the WJC and the Jewish Agency were the most influential.

Druks noted that Leon Kubowitzki, head of the WJC Rescue Department, did not advocate bombing. Kubowitzki believed that "the destruction of the death installations cannot be done by bombing from the air, as the first victims would be the Jews."¹⁷ Druks then summarized the efforts of the Jewish leaders to spur the American government into

¹⁶ Ibid, p. 307.

action. His argument, although polemic and emotional, exposed the role of the various Jewish groups and leaders in trying to spur the American government into rescuing Jews from the Nazis.

Apart from Hilberg and Feingold, the early period of literature covering the debate did not rate as good historical scholarship. Hilberg's work appeared before the declassification of necessary government sources. Still, all of these works defined the problem and paved the way for later scholarship when those sources became available.

1977 - 1978: THE DEBATE IS IGNITED

In May 1978, David S. Wyman, Professor of American History at the University of Massachusetts at Amherst, published an article that has since defined the bombing argument. Entitled "Why Auschwitz Was Never Bombed," and appearing in Commentary, it, for the first time, incorporated broad analysis of the Jewish, American, and British actions with an analysis of Allied bombing capabilities. The article contained no footnotes and only a guide to "basic sources used" at the end.¹⁸ Wyman responded to this criticism in the magazine's July issue by offering to supply a fully footnoted version of the article to anyone providing a self-addressed envelope and paying copying fees.¹⁹ Wyman made good use of the article. With footnotes added and only minor changes, the

¹⁷ A. Leon Kubowitzki to John Pehle, 1 July 1944, World Jewish Congress, New York as quoted in Herbert Druks, Failure to Rescue (New York: Robert Speller & Sons, Publishers, Inc., 1977), p. 65.

¹⁸ David S. Wyman, "Why Auschwitz Was Never Bombed," Commentary 65 (May 1978): 37-46.

¹⁹ David S. Wyman in "Letters From Readers" section, Commentary 66 (July 1978): 12.

article became Chapter XV of his 1984 book, The Abandonment of the Jews.²⁰ In 1990, he wrote a brief entry in the Encyclopedia of the Holocaust summarizing his bombing thesis.²¹ Also in 1990, he edited the thirteen-volume America and the Holocaust. This collection presented the documentation he used for Abandonment, and volume twelve, Bombing Auschwitz and The Auschwitz Escapee's Report, corresponded to Abandonment's Chapter XV. Finally, in 1994 the U.S. Holocaust Research Institute used the article (with only minor adjustments in style) in one of its initial publications, Anatomy of the Auschwitz Death Camp.²² He presented his argument focusing on two main points: requests for action and government responses; and the availability, feasibility, and justification of air bombardment operations.

Wyman opens his argument by summarizing the requests from various persons and organizations to the Allies (specifically the United States) to bomb the Auschwitz facilities and railways used for transporting the Jews there. Such requests began in earnest by the spring of 1944 when the Nazis began concentrating Hungarian Jews for deportation and destruction. Throughout the spring and summer of 1944, the Allies received information from various governments and Jewish groups (again, the most prominent being the WJC and Jewish Agency) on Nazi activities and operations at Auschwitz. These reports included a thirty-page report from two Slovakian Jews, Rudolf Vrba and Alfred Wetzler, who escaped from Auschwitz in April. Their account detailed

²⁰ David S. Wyman, The Abandonment of the Jews: America and the Holocaust, 1941-1945 (New York: Pantheon Books, 1984), pp. 288-307.

²¹ Encyclopedia of the Holocaust, Volume 1 (1990), Israel Gutman, Editor-in-Chief, s.v. "Auschwitz, Bombing of" by David S. Wyman, pp. 119-121.

the camp's geographical layout, living conditions, and Nazi killing techniques. The accuracy of using these reports for intelligence information came under fire in articles written by James Kitchens and Richard Foregger in 1994 and 1995. Combined with other reports, Wyman says that by late June 1944 the "truth about Auschwitz. . . was known to the outside world."²³

Jewish groups continued to press the U.S. for actions to save the European Jews. Most of these appeals ended up at the War Refugee Board (WRB), established by President Franklin D. Roosevelt on 22 January 1944 under Executive Order 9417. The board's objective included taking "all measures within its [the government's] power to rescue the victims of enemy oppression who are in imminent danger of death."²⁴

Although the WRB encompassed members from three different government departments, its executive director became career Treasury Department official John W. Pehle. Pehle's contact within the War Department became Assistant Secretary of War John J. McCloy.²⁵ Communications between these two men offer the evidence of the 1944 debate concerning military action to save European Jewry. However, the War Department's Operations Division (OPD) continually turned down proposals for bombing Auschwitz or its rail-links, claiming that it would entail "diversion of considerable air support essential

²² Yisrael Gutman and Michael Berenbaum, eds., Anatomy of the Auschwitz Death Camp (Bloomington: Indiana University Press, 1994), pp. 569-587.

²³ Wyman, "Why Auschwitz Was Never Bombed," p. 37.

²⁴ U.S., President, Executive Order 9417, "Establishing a War Refugee Board," 22 January 1944, RG 165, Records of the War Department General and Special Staffs, CAD 383.7; National Archives, Washington, D.C.

²⁵ Wyman, "Why Auschwitz Was Never Bombed," p. 38.

to the success of our forces now engaged in decisive operations.”²⁶ Wyman identified this quote, and variations of it, as the War Department’s almost automatic response to requests for military action to save Jews. However, Wyman did not include in his argument the fact that the Executive Order allowed for such a response. Beginning where Wyman left off, the Executive Order stated, “and otherwise to afford such victims all possible relief and assistance consistent with the successful prosecution of the war.”²⁷ Wyman ignored this clause and continued to document various requests and actions by Jewish groups and the WRB throughout the summer and fall of 1944--the last effort coming in November 1944.²⁸ Using the War Department’s explanations for not conducting the operations, Wyman then examines the validity of the excuse.

Wyman used several points to refute the War Department’s statements, and why he believed the Allies retained the ability to conduct bombing operations. First, he stated the Allies, by their own reports, admitted air superiority and bombing capability over the European continent. Also, with the Luftwaffe virtually destroyed, the only serious impediment to the bombers became anti-aircraft artillery (AAA).²⁹ With the Fifteenth Air Force (15th AF) operating from Foggia, Italy, the Allies could now target facilities in central and eastern Europe. Wyman used the “oil war” to further enhance his argument. In this effort, the Allies pursued destruction of Germany’s ability to refine oil and manufacture synthetic oil.

²⁶ Quoted in Wyman, “Why Auschwitz Was Never Bombed,” pp. 38-39.

²⁷ Executive Order 9417, RG 165, CAD 383.7, NA.

²⁸ Wyman, “Why Auschwitz Was Never Bombed,” pp. 38-41.

²⁹ *Ibid*, pp. 41-42.

Beginning in late June, the Allies began attacking the vast German synthetic oil industry in Upper Silesia. Wyman noted that Auschwitz sat within a thirty-five mile radius of least eight important oil targets--the most important being Blechhammer.³⁰ He proceeded to note the air bombardment operations in the area between July and November 1944. He also noted the location of important railroads and rail marshaling yards along the bombers' routes. Wyman also briefly examined the Allies' ability to accurately bomb the crematorium and gas chambers at Auschwitz. While this portion of his argument lacked supporting documentation and technical information this assertion created much of the published reaction to his article.

Finally, Wyman briefly discussed Allied non-military support operations in Europe for other causes. He mentioned the operations to transport Polish and Balkan refugees to camps in Africa and the Middle East, and the airlifting of wounded Yugoslav partisans.³¹ This point raised doubts about the War Department's reasoning in refusing to aid the Jews. Wyman displayed how the War Department, on several occasions, failed to intervene in rescue operations by saying that they would have diverted necessary resources from the war effort. However, he noted the use of American airpower to support the 1944 Warsaw uprising and a report saying the action "[d]espite the tangible cost which far outweighed the tangible results achieved, it is concluded that this mission was amply justified."³²

³⁰ Ibid, p. 42.

³¹ Ibid, p. 45.

³² Quoted in Wyman, "Why Auschwitz Was Never Bombed," p. 46.

Wyman devoted less than a page to perhaps the most troubling question of all--the moral implications of saving Jews from the Nazis while probably killing some of them in carrying out the operations. Wyman's 1978 article began the debate, but gave little attention to the argument's moral dimension. Since the article's publication, discussions of the Auschwitz bombing debate continued to center around Wyman's thesis--especially the technical abilities of the Allies to carry out the proposed mission. The troubling moral issue, implicit in Wyman's article, also received much attention.

The first counter-arguments to Wyman's article were not long in coming. The July 1978 Commentary (the next issue after Wyman's article appeared) included over three pages of editorial comments and included Wyman's rebuttal to those letters. Lawrence H. Blum opened a now much-discussed argument by saying that "aerial bombardment during World War II simply was not as accurate as civilians were led to believe."³³ However, he pointed out that although difficult and dangerous, the missions remained achievable. Also, he noted that the Allies controlled another asset more appropriate for the mission than U.S. high-altitude bombers (most people, when arguing to bomb Auschwitz, concentrate on the most famous bomber of the war, the U.S. Boeing B-17 Flying Fortress). As Blum rightly pointed out, British de Havilland D.H. 98 Mosquitoes conducted a successful attack on a small target on 18 February 1944 (Operation Jericho) when they bombed the Amiens jail. The attack allowed some French Resistance Fighters awaiting execution to escape (although some died from the bombing

³³ Lawrence H. Blum in "Letters From Readers" section, Commentary 66 (July 1978): 7.

and the Germans recaptured most of the escapees).³⁴ In response to Blum, Wyman asserted that he “did not assert that pinpoint bombing accuracy could be assumed.”³⁵ Instead, he suggested a variety of measures, including saturation bombing from high altitude; the use of “more accurate” medium bombers; utilization of Mosquito bombers (as Blum suggested); or bombing with the Lockheed P-38 Lightning dive bombers.³⁶

The next letter in the July Commentary came from Herbert Loebel. He began by noting his internment in the “Gypsy” camp located “about 200 yards from the crematoria.”³⁷ He recounted the first week of October 1944 when he heard anti-aircraft fire and hoped “that Allied bombers had finally come to put an end to this inferno. They didn’t.”³⁸ He also noted that the crematoriums each emitted “a red fiery plume, each one about 75 feet long” capable of being used for navigational aids for night bombing runs by B-17s.³⁹ Bombing, he concluded, would force the Germans to halt using the ovens at night, saving lives.

Commenting on Loebel’s letter, Wyman said he found no archival evidence of Air Force planners referring to the chimney fires at Auschwitz. Furthermore, he said 15th AF conducted no night raids into the Auschwitz region except for one small raid to Blechhammer on 13 November.⁴⁰

³⁴ Ibid.

³⁵ David S. Wyman in “Letters From Readers” section, Commentary 66 (July 1978): 11.

³⁶ Ibid.

³⁷ Herbert Loebel in “Letters From Readers” section, Commentary 66 (July 1978): 7.

³⁸ Ibid, pp. 7-8.

³⁹ Ibid, p. 8.

⁴⁰ Ibid.

The first letter to repudiate Wyman's thesis came from Milton Groban, who had flown as a radar navigator-bombardier on the first raid of the nearby oil facilities on 20 August 1944. His service also included being a staff operations officer at Fifteenth Air Force headquarters in Bari, Italy where he participated in the daily selection of targets and route planning. He recalls that the planning process always strove to avoid the possibility of harming prisoners. He called Wyman's plan "Kapo morality--kill some now to save some later"⁴¹ and divided his argument into four areas: Accuracy; Efficacy; Diversion of Forces; and Rail.

Groban meticulously described the bombing procedure used for attacking targets. He noted that due to the inaccuracy of high-altitude bombing (a result of tactics, technology, and German countermeasures), they frequently used "carpet bombing." Carpet bombing consisted of dropping twelve 500-pound bombs released sequentially to achieve 400-foot spacing on the ground. Therefore, each bomber would lay a "stick" of bombs 4,800 feet long.⁴² Noting Wyman's calculations of the crematorium sizes (two being 340 feet long, and two more two-thirds that size), he said bombers could "probably" hit them, but it would entail approximately 6,000 bombs saturating the camp environs. For reason of efficacy, Groban believed bombing the camp would prove useless. He described many alternative methods available to the Nazis to improvise their mass killing (firing squads, and using sealed barracks' as gas chambers).

⁴¹ Milton Groban in "Letters From Readers" section, Commentary 66 (July 1978): 10.

⁴² Ibid.

Groban dismissed Wyman's belief in the collapse of German air defenses by the middle of 1944. Referring to his combat log for missions flown in August, he called Allied losses "staggering" noting that Fifteenth Air Force (15th AF) lost 100 per cent of its assets in forty-five days of operations. The units overcame losses only by "massive infusions of new aircraft and crews."⁴³ Due to the losses, he noted that 15th AF carefully protected its resources and selected targets best designed to "destroy Hitler's Germany and end the war."⁴⁴ Finally, Groban said the interdiction of rail lines proved ineffective. He participated on a mission to bomb the Reccos marshaling yard at Budapest on 27 June 1944, but the raids proved ineffective at slowing deportations of Hungarian Jews. He also noted that the bombers dropped mixed loads of bombs with delayed fuses at 24, 48, and 72 hours to hamper repair operations.

Groban agreed with Wyman that the World War II U.S. government owes an explanation as to why they denied Jewish refugees entry. However, he disagreed with Wyman on extending this blame to include failure to bomb Auschwitz. He closed his letter by introducing a "retrospective fantasy":

On August 20, 1944, as I train my sights on the refinery targets at Auschwitz, I receive orders to alter course and bomb the camp. The Jews are huddled below watching the innocent white vapor trails in the blue sky. I, a Jew, make corrections as the target moves into my bombing sight. My bomb-bay doors open; the planes purposively thundering behind me open theirs. My hand moves to the bomb release--I am the ultimate Kapo.⁴⁵

⁴³ Ibid, pp. 10-11.

⁴⁴ Ibid, p. 11.

⁴⁵ Ibid.

Of all the letters in the July Commentary, Wyman gave the most space to his rebuttal to Groban. Wyman began by restating his position of not advocating “prophylactic bombing” of Auschwitz. He then quickly moved to the morality question, claiming that Groban’s accusation of “‘Kapo morality’ is offensive and inaccurate.”⁴⁶ Wyman then counters Groban’s four points. Regarding accuracy, Wyman reasserted his belief that the crematoriums could have been precision targets subject to bombing by heavy bombers flying at altitudes from 20,000 to 26,000 feet. Wyman then countered Groban’s belief in the German’s ability to quickly adapt their killing measures. The manpower shortage and alternative killing methods forced by destruction of the gas chambers and crematoriums, Wyman stated, would have slowed the killing process. Wyman then discounts Groban’s diversion of forces argument. He restated the position that the camps in the area of the oil facilities provided a viable target without additional diversions. Finally, Wyman agreed that the effect of bombing rail lines was temporary, but he stated, “deportation trains could not have been blocked by hitting just any marshaling yard or stretch of track at random.”⁴⁷ Wyman concluded by reasserting his belief in the necessity of action.

With the initial reactions to Wyman’s article subsiding, the next appearance of the topic occurred on 24 November 1978. Roger M. Williams, the Senior Editor of Saturday Review, published “Why wasn’t Auschwitz Bombed?” in the Catholic periodical Commonweal. Williams’ work lacked footnotes and references, but generally followed

⁴⁶ Ibid.

⁴⁷ Ibid, p. 12.

along the lines of Wyman's argument. He directly accused the U.S. government of apathy towards the European Jews, and wrote "[b]y failing to intervene with bombs, rather than words, it sealed the fate of many thousands of innocent people."⁴⁸ He also looked back at thirty years of Holocaust scholarship and noted:

[T]he bombing issue burns with surprising intensity. . . . The advocates tend to be more righteous than reasoned and to ignore facts that undercut their arguments. Yet their central contention is damningly correct. The United States had the capability to put Auschwitz out of business, with minuscule damage to the war effort. What it lacked was the will--more basically, the concern.⁴⁹

Williams asserted that the combination of military leaders' unwillingness to participate in rescue operations, and the political implications Roosevelt faced for turning the war into one of saving Jews, led to inaction. He said the President "could not afford—for the war effort or his own political future—to allow the Allied cause to become identified as a war for Jews."⁵⁰

He does, however, add to the technical debate. Using an idea, borrowed from Wyman, of U.S. aircraft landing in Allied or partisan-held territories, Williams said the Soviets (he refers to them as "Russians") held the key to effectively bomb Auschwitz. By using their territory, the Allies could use smaller, more accurate aircraft, but the Soviet military insisted on absolute control over target selection for bombers that used their territory as a staging area.

Still, what separates Williams' article from the others remained the veiled accusation of antisemitism of the U.S. leaders. "Had Auschwitz's victims been

⁴⁸ Roger M. Williams, "An American Moral Tragedy: Why wasn't Auschwitz Bombed?" Commonweal 105 (24 November 1978): 746.

predominantly Englishmen,” he claimed, “and probably if they’d been gentiles of any nationality, powerful Americans would have urged bombing--and the government would have taken heed.”⁵¹ However, he also chided Jewish leaders for lacking cohesion, and said most wanted non-military measures to save the Jews.⁵² Although Williams remained a proponent of bombing Auschwitz and the railroads feeding it, he cited the ethical implications of probably killing prisoners to possibly save other prisoners.

He agreed that bombing the camp would undoubtedly caused many deaths (he wrote “perhaps dozens”), but believed that the action remained justifiable. In another attack on U.S. leadership, he noted “[b]esides, Allied air forces already were killing untold thousands of other innocents--slave laborers in German plants--without any apparent qualm.”⁵³ He closes by stating the United States failed in its “transcending moral obligation to act,” even if only for larger, symbolic reasons.⁵⁴

The debate, begun in the 1960s and inflamed by David Wyman in 1978, erupted into an important historical controversy achieving immediate responses. The historical argument for why the Allies did not use airpower to try to halt the Nazi death machinery would intermittently continue over the next eleven years.

⁴⁹ Ibid.

⁵⁰ Ibid, p. 747.

⁵¹ Ibid, p. 750.

⁵² Ibid.

⁵³ Ibid, p. 751.

⁵⁴ Ibid.

1979-1989: THE DEBATE SLOWLY SIMMERS

The next publication that addressed the possibilities of using airpower to save the Jews came in 1979. The 1978 publications, while mentioning the "Allies," usually concentrated on American airpower and the Roosevelt administration's inaction. Bernard Wasserstein's 1979 book, Britain and the Jews of Europe, 1939-1945, as its title notes, concentrated on the British aspect of the question. In the later part of his chapter covering the Jewish Resistance, Wasserstein covered the topic as it was debated in Churchill's government.⁵⁵ Following the same basic pattern as earlier arguments, he addressed the requests for bombing by Jewish groups--including the influential Jewish Agency led by Chaim Weizmann; the debate within and between British governmental agencies; technical and ethical aspects of bombing (although Wasserstein largely glosses-over these aspects); and a conclusion explaining the British inaction.

The Polish government in London sent a telegram to the Polish Home Army on 24 August 1943, stating that the British Staff expressed a desire to bomb industrial targets around Auschwitz. In the message, the Polish representatives wrote, "[f]or our part we would like to combine it with a mass liberation of inmates from Auschwitz."⁵⁶ In fact, Wasserstein found no evidence that the British Air Staff considered these targets as of this early date. The distance of these targets from heavy bomber bases in England continued to cause the delay. However, Wasserstein (like Wyman) noted the capture of the southern Italian airfields. On 1 December 1943, 15th AF Headquarters moved from

⁵⁵ Bernard Wasserstein, Britain and the Jews of Europe, 1939-1945 (New York: Oxford University Press, 1979), pp. 305-320.

Tunis, Tunisia to Bari, Italy.⁵⁷ The move of units from North Africa to Italy brought the bombers 475 miles closer to the theater of operations. Still, the range to targets in Upper Silesia remained at the extreme edge of operational limits.

Like Williams, Wasserstein also looked at the possibility of Soviet aid for the effort. He cited one mission on 21 June 1944 when American bombers landed in the Soviet Union after bombing targets, but “after their cool reception there the experiment was discontinued.”⁵⁸ Also, Wasserstein noted Churchill’s own history of Allied wartime relations. By September 1944, friction between the Allies led Stalin to refuse British and American aircraft landing rights on Russian soil during the revolt of the Polish Home Army in Warsaw.⁵⁹

The Jewish Agency request to the British arrived on 6 July 1944 at the office of Foreign Secretary Sir Anthony Eden. Its appeal requested bombing the Birkenau complex and railroads from Budapest to Auschwitz. Moshe Shertok, head of the Jewish Agency’s Political Department, argued the bombing would incur “many-sided and far-reaching moral effect[s].”⁶⁰ He outlined five of these effects, the fourth being:

[I]t would give weight to the threats of reprisals against the murderers, by showing that the Allies are taking the extermination of Jews so seriously as to

⁵⁶ Polish Underground Movement (1939-45) Study Trust 4514/43 as quoted in Wasserstein, p. 308.

⁵⁷ Dennis F. Casey and James R. Davis, Vezzano to Desert Storm: History of Fifteenth Air Force, 1943-1993, (n.p.: Department of the Air Force, [1991]), p. 4.

⁵⁸ B. H. Liddell Hart, History of the Second World War (New York: Putnam, 1973), p. 637 as quoted in Wasserstein, p. 309.

⁵⁹ Winston Churchill, Second World War, 6 vols., (Boston: Houghton Mifflin Company, 1953), vol. 6: Triumph and Tragedy as quoted in Wasserstein, p. 309.

⁶⁰ Aide-mémoire left with Eden by Weizmann and Shertok, 6 July 1944 as quoted in Wasserstein, p. 310.

warrant the allocation of aircraft resources for this particular operation, and thus have a deterrent effect.⁶¹

Eden replied that the government would again reexamine such plans and took the problem to the Prime Minister. Churchill agreed that Auschwitz should be bombed and told Eden, “[g]et anything out of the Air Force you can and invoke me if necessary.”⁶²

However, like the situation in the U.S. government, the topic was bounced around various government agencies until late 1944. Wasserstein noted that while the Air Staff asked for more intelligence information (including topographical layout), such information became “lost” in the bureaucratic crevices. “The result,” wrote Wasserstein, “was a striking testimony to the ability of the British civil service to overturn ministerial decisions.”⁶³

However, Wasserstein did not accuse the bureaucrats of antisemitism, but said that within the government, the saving of Jewish lives was not among the primary British war aims.

As such, rescue operations did not receive high priority and could only have been attempted if they did not divert resources from the defeat of Germany.⁶⁴

Wasserstein also covered another new area. He noted that the Germans learned of the proposed bombardment via an intercepted telegram. The intelligence came to the attention of Gestapo Chief Ernst Kaltenbrunner, Foreign Minister Joachim von Ribbentrop, and the Hungarian Government. The Nazis halted the practice of burning bodies in open trenches at night when anti-aircraft units near Auschwitz complained the

⁶¹ Ibid.

⁶² Churchill to Eden, 7 July 1944, PRO FO 371/42809/135 as quoted in Wasserstein, p. 311.

⁶³ Wasserstein, p. 316.

⁶⁴ Ibid, p. 320.

practice would aid Allied bombers (note the similarity to Loebel's letter in Commentary referring to the fire from the crematorium smokestacks).⁶⁵

Concluding the chapter on resistance, Wasserstein placed the failure of the British to use airpower to bomb the means of genocide in the overall context of British policy toward Jews. He attributed such inaction to British priorities being military targets, and argued that these "secondary" aims would receive attention only if they did not adversely impact resources required for the main objective of military victory over Germany.⁶⁶

Wasserstein added the important and, up to then, overlooked British dimension to the debate. Still, it took two years for the next, and perhaps most important scholarly work on the argument to arrive. In 1981, Martin Gilbert, the renowned British historian, published Auschwitz and the Allies.

The book traced the history of when and how Nazi atrocities became known to the Allies, and how the Allies responded to the news. Gilbert provided a balanced view, noting the piecemeal and scanty nature of the initial evidence. He also mentioned that when the evidence became stronger in 1944, the Allied response could not include military action. The initial information to the west coincided with a period of German military superiority and Allied weakness. However, Gilbert believed skepticism, disbelief, political considerations, and prejudice caused Allied inaction in 1944.⁶⁷

Part Three of the work, "Auschwitz Revealed," detailed the full story of Auschwitz as it became known to the Allies, as well as Allied actions and reactions.

⁶⁵ Ibid, p. 320.

⁶⁶ Ibid.

Using materials already cited by Wasserstein and Wyman, he added expanded evidence and a more complete account of the previous authors' discussions. One important area Gilbert expanded upon included the railroad network as it pertained to the Allied bombing effort.

On 2 June 1944, the Allied Operation FRANTIC began. The effort carried two objectives: impress the Soviets by the effectiveness of Allied air operations; and distract the Germans from the Normandy coast as the landing date neared.⁶⁸ The operation included a shuttle bombing system where bombers staging from Foggia, Italy or England could use Poltava airfield in Russia. Initial FRANTIC targets included the Drohobycz oil plants and the Debrecen railroad marshaling yards in Hungary (the former being less than 150 miles southeast of Auschwitz). Although the post-mission reports detailed success against the latter target, a memorandum from the Ministry of Economic Warfare on 2 June set out arguments against bombing railroads. The memorandum stated that the bombing of railroads in northwestern Europe offered little effectiveness due to the density of the system and the availability of alternative routes. However, attacking the railroads of southeastern Europe (including Hungary, Romania, Serbia, and Bulgaria) would offer longer lasting effects due to non-availability of alternative routes and repair facilities.⁶⁹

As information on Auschwitz and its purpose came to light in 1944, requests by Jewish leaders for Allied action became more numerous and intense. On 23 June, new information reached the west concerning the deportation of 435,000 Hungarian Jews. As

⁶⁷ Martin Gilbert, Auschwitz and the Allies (New York: Henry Holt and Company, 1981), p. viii.

⁶⁸ *Ibid.*, p. 220.

officials in Washington turned down requests to bomb Auschwitz and railroads leading to it, the War Refugee Board representative in Bern, Switzerland, Roswell McClelland, received the new information from Jewish officials there. Gilbert then detailed the frantic actions that followed. McClelland forwarded the messages, which included six specific proposals, to Washington. The proposals stipulated two bombing mission targets: the Auschwitz and Birkenau camps--especially the gas chambers and crematoriums; and six specific rail lines to stop the deportation (the main line, Kosice, included a vital railroad bridge).⁷⁰ When the telegram reached the WRB in Washington, board member Benjamin Akzin added several key observations.

Akzin immediately argued for the bombings to save inmate lives, to kill Nazis, and "as a matter of principle."⁷¹ He also believed the effort would not divert resources from ongoing air operations as the Allies continued to bomb industrial targets in the Auschwitz area. Noting the possible moral conflict, he ended his memo saying, "[p]resumably a large number of Jews in these camps may be killed in the course of such bombings (though some may escape in the confusion). But such Jews are doomed to death anyhow. The destruction of the camps would not change their fate, but it would serve as visible retribution on their murderers and it might save the lives of future victims."⁷²

⁶⁹ Ibid, pp. 220-221.

⁷⁰ Quoted in Gilbert, p. 246.

⁷¹ Ibid, p. 247.

⁷² War Refugee Board, Box 35, Measures Directed Towards Halting Persecution, F. Hungary No. 5 as quoted in Gilbert, pp. 247-248.

Akzin continued his efforts to obtain action from the War Department. He pointed out to Pehle the “habitual reluctance of the military to act upon civilian suggestions.”⁷³ Furthermore, he noted that the WRB’s function existed to “overcome the inertia” and urged Pehle to go directly to President Roosevelt who, he believed, “would order the immediate bombing of the objectives suggested.”⁷⁴ Gilbert, throughout Part Three, covered the evidence already presented by Wasserstein and Wyman in further detail. As before, the authors’ evidence pointed to Allied inaction, who cited diversion of assets necessary for the quickest defeat of Nazi Germany. The most important and new discovery made by Gilbert became the evidence of Allied intelligence information.

Gilbert’s book was the first to integrate photographs uncovered and analyzed by CIA personnel in 1979. These were published in a short monograph entitled The Holocaust Revisited, a Retrospective Analysis of the Auschwitz-Birkenau Extermination Complex.⁷⁵ Gilbert determined that the first Allied reconnaissance mission over the Auschwitz area occurred on 4 April 1944. A South African reconnaissance plane photographed the I.G. Farben synthetic oil and rubber manufacturing plants at Monowitz (four kilometers east of Auschwitz). The photographs, analyzed by both RAF and American intelligence personnel, detailed much information on the industrial targets. Of the twenty-three frames, three contained the Auschwitz I complex (the main camp), but received no annotations. Gilbert noted that the rows of huts resembled barracks, army

⁷³ Akzin to Pehle, 2 September 1944 quoted in Gilbert, p. 312.

⁷⁴ Ibid.

⁷⁵ Dino A. Brugioni and Robert G. Poirier, The Holocaust Revisited, a Retrospective Analysis of the Auschwitz-Birkenau Extermination Complex (Washington, D.C.: Central Intelligence Agency, 1979).

camps, prisoner-of-war camps, and labor camps appearing in many other photos.⁷⁶ A second reconnaissance flight over the area on 31 May showed all of Birkenau and parts of the Auschwitz main camp.⁷⁷ A second written report on 6 June included the 4 April photograph documentation supplemented by a “ground source” later identified as an escaped Belgian student. The notes indicated that intelligence sources knew the source of the labor at the oil refinery since three areas became annotated as “Concentration Camp” and “Labour Camp.”⁷⁸

The third reconnaissance mission over the area occurred on 26 June. One frame showed the whole of Auschwitz and Birkenau. An extremely detailed analysis of the photographs occurred on 28 June concentrating on the oil production facilities. Gilbert noted the report included no references to the camps, but added “[t]his section of the photograph was clearly of no relevance to those whose task was to pinpoint the industrial production of oil and rubber.”⁷⁹ However, he stated that by looking at the photograph in conjunction with the Vrba-Wetzler escapee report, one can identify all of the camp’s main features.⁸⁰ A fourth mission, on 8 July, only photographed part of Auschwitz I and again included no annotations. Two additional missions occurred on 9 and 12 August, but the poor image quality precluded their effective use.

The Allies obtained the best aerial photography on 25 August. These pictures clearly showed the Auschwitz main camp, Birkenau (Auschwitz II), and the railway spurs

⁷⁶ Gilbert, pp. 190-191.

⁷⁷ Ibid, p. 216.

⁷⁸ Ibid, p. 222.

⁷⁹ Ibid, p. 250.

⁸⁰ Ibid.

leading to the them. Other visible details included the outline of the underground gas chambers, the gas chamber ceiling vents, and open pits behind one crematorium. One of the frames even included Jews on the way from a train to a gas chamber and crematorium building, and recent arrivals lining-up to register. Due to this mission's purpose as a post-strike reconnaissance on a bombing mission over Monowitz, the annotations described craters, damage, and repair efforts. Still, the only annotation of the camps included labeling Auschwitz III as "Concentration Camp."⁸¹ Auschwitz III, also called Monowitz, included the industrial section and the Buna Werke (synthetic oil and vulcanized rubber plants owned by I.G. Farben), and several satellite camps. Other post-

⁸¹ Ibid, p. 310.

Figure 1: Reconnaissance Photograph Taken 26 June 1944⁸²

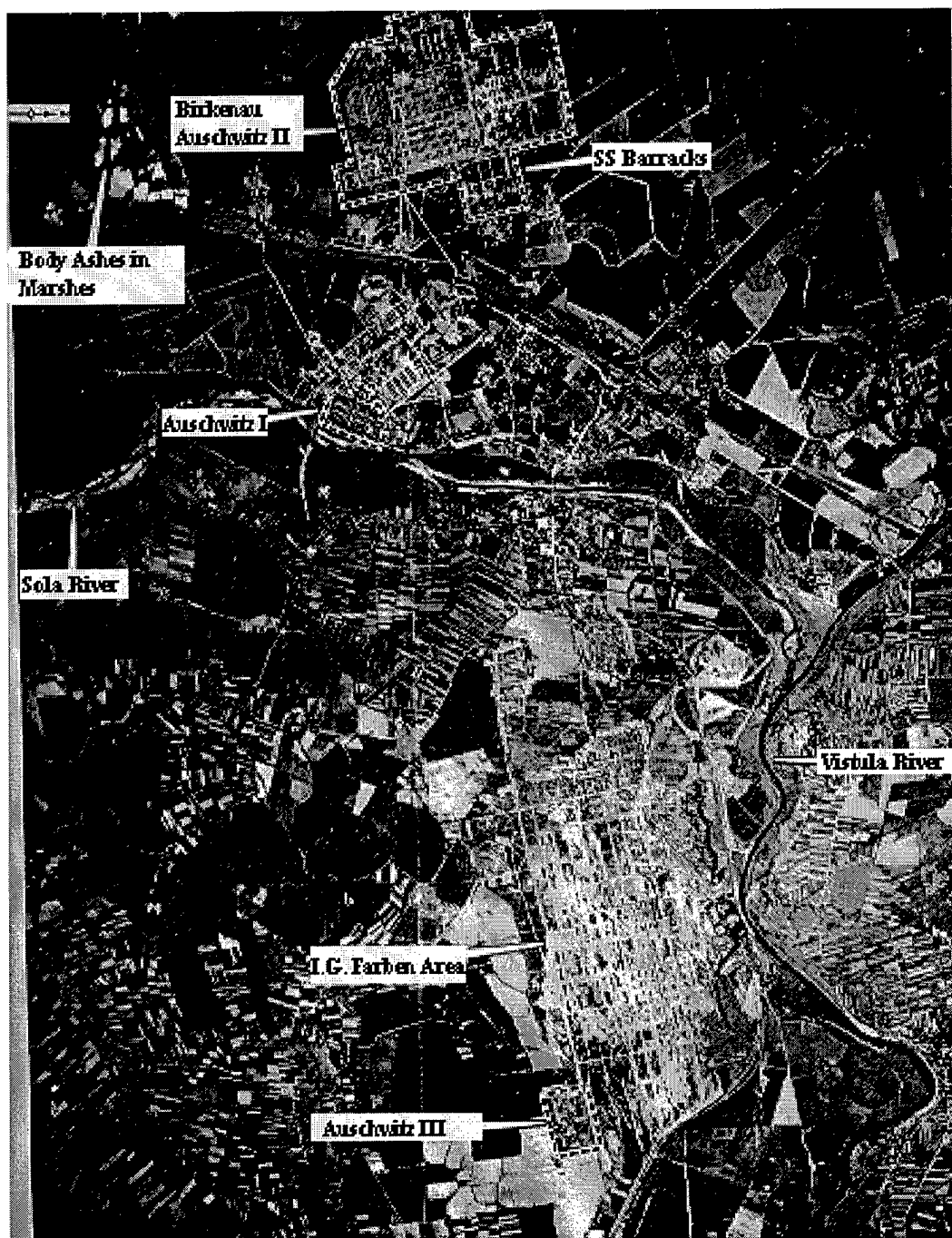

⁸² Ibid, photograph section between pp. 192-193.

strike reconnaissance occurred on 13, 16, and 18 September, and 16 October. Again, the photograph's annotations referred only to activity around the oil facilities.⁸³

As Gilbert pointed out, the failure to correctly and fully identify features of the camps cannot rest with the photo interpreters. Because of war constraints, their specific jobs limited them to analyzing the industrial targets. According to Gilbert, the failure occurred at higher levels when the Allies did not marry known photographic intelligence with other sources--including the escapee's reports, sketch maps, and information provided by the many Jewish backers of the bombing plan. Gilbert believes no such effort occurred because the Allies already decided against bombing the camp. In his final analysis the ultimate failure rested with the American and British civilian governments. Gilbert, like Wasserstein, said a few individuals decided no bombing should occur and stone-walled the wishes of powerful elected leaders. On the American side, while Gilbert blamed the War Department for using weak excuses to justify the refusal to bomb, the ultimate responsibility must lie with the WRB. Its delays and passive efforts allowed the opportunity to slip away. "The failures, shared by the Allies," Gilbert claimed, "were those of imagination, of response, of Intelligence, of piecing together and evaluating what was known, of co-ordination, of initiative, and even at times of sympathy."⁸⁴ He also attributes the lack of bombing to Nazis' success in their deception measures. They effectively hid the killing acts and the evidence of the killings.⁸⁵

⁸³ Ibid, pp. 317 and 321.

⁸⁴ Ibid, p. 341.

⁸⁵ Ibid.

Gilbert's book received acclaim, but did not stir-up any additional debates like those Wyman caused in 1978. In fact, it took two years for another book to examine the debate--and it did so more with a damning passion than with clear, historical objectivity.

Monty Noam Penkower's The Jews Were Expendable exceeded Druks' argument in its passion to condemn. Penkower covered the bombing debate in his seventh chapter, "Auschwitz-Birkenau and the Martyrdom of Hungarian Jewry," but failed to add any new information. He covered the same information as Wyman, Gilbert, and Wasserstein, and his footnotes documenting the coverage referred to these authors' works and not any primary sources. However, the lack of new material did not preclude him from reaching radical conclusions. He believed that the Allied leaders, in part due to antisemitism, "misjudged its [the Holocaust's] dimensions and denied that the Jews were an entity meriting distinct consideration. . . .The abdication of moral responsibility to defenseless human beings reflected itself in other ways as well [referring to the failure to institute other rescue efforts]."⁸⁶

The next article on the debate appeared in 1983. Dino Brugioni, one of the CIA analysts whose 1979 photographs Gilbert used, wrote an article for the magazine Military Intelligence titled "Auschwitz-Birkenau: Why the World War II Photo Interpreters Failed to Identify the Extermination Complex." He cited five reasons why the interpreters failed to annotate and report on the camps in the photographs. First, he

⁸⁶ Monty Noam Penkower, The Jews were Expendable: Free World Democracy and the Holocaust (Chicago: University of Illinois Press, 1983), p. 215.

identified "tasking. . . a military intelligence term meaning requirements imposed."⁸⁷

Due to the scale of the war, interpreters operated under a complicated priority system to produce timely intelligence. None of these priorities included searching for, or exploiting photos of, concentration camps.

"Priority Projects" appeared as the second reason. Brugioni identified the two principle units performing photo interpretation as the Allied Central Interpretation Unit at RAF Station Medmenham, England, and the Mediterranean Allied Photo Reconnaissance Wing in Italy. Both organizations worked continuous shifts, and in 1943 and 1944 their work increased due to preparations for the landings at Normandy and in southern France, and the increased tempo of Allied bombing operations. The Medmenham unit alone took in an average of 25,000 negatives and 60,000 prints on a daily basis.⁸⁸

Thirdly, he mentioned training. Trainees attended a four-to six-week course to learn the basics of identifying military equipment. Senior interpreters worked more on pre- and post-strike analysis of specific types of military and industrial targets. The military trained no interpreters on concentration camp analysis. In fact, when labeling such camps, the interpreters could not and did not make distinctions between the different types of camps (labor, concentration, prisoner-of-war).⁸⁹

"Precedence" was the fourth reason noted by Brugioni. To accomplish photo analysis, interpreters depended upon existing knowledge to identify specific items. Brugioni stated, "[t]here simply was no historical or intelligence precedence for genocide

⁸⁷ Dino A. Brugioni, "Auschwitz-Birkenau: Why the World War II Photo Interpreters Failed to Identify the Extermination Complex," Military Intelligence, Vol 9, No. 1 (January-March 1983): 50.

on such a scale.”⁹⁰ Also, photo interpretation operated in a vacuum from other intelligence. Their job did not include melding the photographs with other known intelligence information. Therefore, they did not know of the human sources or communications intelligence that contained information about the camps.

Finally, Brugioni described the photo interpretation equipment used during World War II as primitive. The equipment used on the photos containing Auschwitz could magnify imagery four times (similar to a simple magnifying glass).⁹¹ He concluded that these five reasons show why, on their own, photo interpreters did not annotate or report on the Auschwitz camps in the photos of the I.G. Farben factory. However, he believed that if the civilian and military leadership wanted to bomb the camps, and ordered the photo interpreters to perform such analysis, the intelligence information existed to support such a mission. “The ultimate irony,” he claimed, “was that no search for the aerial photos was ever instituted by [the USAAF or RAF].”⁹²

The next contribution to the debate appeared in the Washington post on 17 April 1983. The article, by reporter Morton Mintz, appeared a week after a gathering of American Jewish Holocaust survivors in Washington. Mintz re-examined John McCloy’s role in opposing the bombings. After an interview with McCloy, Mintz contrasted McCloy’s recollections with the available historical research.

⁸⁸ Ibid, p. 51.

⁸⁹ Ibid, pp. 52-54.

⁹⁰ Ibid, p. 54.

⁹¹ Ibid, p. 55.

⁹² Ibid.

Overall, Mintz found McCloy's recollections "unsupported or disputed by official records and historians."⁹³ McCloy insisted he talked to and corresponded with General Henry H. "Hap" Arnold, Commander of the U.S. Army Air Forces (USAAF). No evidence exists to support his claim, and the most prominent Arnold historian, Murray Green, discounts the claim. McCloy claimed that General Arnold played the key role in blocking the bombings. Green also noted that any such decision by Arnold would surely have involved his boss, close friend, and U.S. Chief of Staff General George C. Marshall and Secretary of War Robert A. Lovett.⁹⁴

Mintz also asked McCloy about Roger Williams' statement (1978 article in Commonweal) concerning the victims being gentiles or Englishmen. McCloy responded, "I don't think it was relevant. Not a bit."⁹⁵ McCloy noted that his participation with the Auschwitz bombing issue began with a summons from Harry Hopkins, a top Presidential aide. He recalled Hopkins saying that Samuel Rosenman, regarded as an unofficial special advisor to Roosevelt on Jewish affairs, brought the matter before the President, and Roosevelt "was not disposed to [bombing]."⁹⁶ Wyman (Mintz spoke with Wyman and included his statements in the article) disputed this, saying he continues to search for evidence of Roosevelt's action on the question. Wyman also doubts Hopkins' role in the discussions due to his extreme illness in 1944.⁹⁷

⁹³ Morton Mintz, "Why Didn't We Bomb Auschwitz?" The Washington Post, 17 April 1983, p. D1.

⁹⁴ Ibid.

⁹⁵ Ibid, p. D2.

⁹⁶ Ibid.

⁹⁷ Ibid.

Overall, Mintz placed McCloy's recollections in extreme doubt. McCloy recalled talking to people in conversations that remained unconfirmed by documents and when questioned about specific, documented evidence, he could not remember details. When questioned about possibly intentionally clouding his memory to appease his conscience, he replied, "I wasn't haunted [by the non-bombing] because I didn't have a damn thing to do with [it]. I didn't have any decision to make."⁹⁸

Wyman once again took center stage in the debate in November 1984, when he published his Abandonment of the Jews. The book met with extremely positive reviews and made the *New York Times Book Review's* "Best Sellers" list in March 1985.⁹⁹ As mentioned earlier, the fifteenth chapter presented the Auschwitz bombing issue with only minor stylistic variations from the Commentary article of 1978 (but the book, unlike the original article, did include footnotes).

The year after Abandonment's publication, Historian Lucy S. Dawidowicz wrote a scathing article criticizing Wyman's thesis and rebuked her colleagues for their acceptance of the same. She decried the work as advocating blame and guilt. She separated the scholarship into the two distinct issues, pre-war immigration and refugee policies, and war rescue possibilities.

Dawidowicz questioned Wyman's presentation of Roosevelt as indifferent to Jewish suffering. Calling his thesis "a new version of the past," she rebuked Wyman for

⁹⁸ John J. McCloy, quoted in Mintz, p. D2.

⁹⁹ See New York Times, 4 November 1984, p. C13 and 24 December 1984, p. 11; also New York Times Book Reviews, 16 December 1984, pp. 1 and 16; and 17 March 1985, p. 42.

ignoring the historical context and Roosevelt's motives and large responsibilities.¹⁰⁰ She called Wyman a "natural heir to the Christian moralist tradition" which she defined earlier as "more inclined to make universal moral judgments than to draw political conclusions from history."¹⁰¹ Believing the historical evidence does not support Wyman's thesis, she criticized the work's acceptance:

This extraordinary insight has been embraced by book reviewers, even by some who profess to be historians, and by a large reading public, including many Jews. I have yet to learn of any challenge to Wyman's analysis or conclusion, yet to see if anyone has noticed what is surely a most remarkable historical anomaly.¹⁰²

She believed that Roosevelt prosecuted the war in the proper manner, and American Jews agreed with his policies. They remained loyal to the President, and agreed with him that the best way to help European Jews was the speedy defeat of the Reich's military forces. Bombing Auschwitz, in her opinion, would not have altered the Jew's fate, and presented the 1945 Death Marches as one example of Nazi alternatives and determination to exterminate them.

Also in 1985, the definitive work on the Holocaust appeared. Expanding on his 1961 book, Raul Hilberg published the "Revised and Definitive Edition" Destruction of the European Jews as a three-volume set.¹⁰³ Hilberg included the bombing propositions as part of a larger section discussing rescue operations. Using predominately primary sources, he masterfully recounted the bombing discussions, within both the American and

¹⁰⁰ Lucy S. Dawidowicz, "Could the United States Have Rescued European Jews from Hitler," This World, Fall 1985, Issue 12, pp. 14-15.

¹⁰¹ *Ibid*, pp. 15 and 17.

¹⁰² *Ibid*, p. 18.

¹⁰³ Raul Hilberg, Destruction of the European Jews, Revised and Definitive Edition, 3 vols. (New York: Holmes & Meier, 1985).

British governments. He also included details on Allied bombing missions and reconnaissance operations over Monowitz. Although not as detailed as the accounts of Kitchens, Foregger, or Brugioni, Hilberg provided more relevant information than Wyman's works.

The significance of Hilberg's argument came not from any new information he revealed, but his conclusions. He did not lay the blame totally at the feet of the Allied governments or military staffs. Instead, he offered an impartial assessment. He blamed the Jews for presenting incomplete and uncoordinated propositions. He attributed the Allies with not offering earnest attention to the bombing proposals.¹⁰⁴ However, Hilberg ended by offering the fairest and most perceptive conclusion to date:

More fundamentally, bombing was an idea whose time had not come. Neither Jewish traditions nor allied doctrines could make it an imperative. The Jewish leaders were not accustomed to thinking about rescue in terms of physical force, and Allied strategists could not conceive of force for the purpose of rescue.¹⁰⁵

As will be discussed later in this chapter, this evenhanded conclusion escaped James Kitchens. Kitchens preferred to view the Holocaust scholars as a single-minded group blaming only the Allies for their inaction.

In the nine years since Wyman fanned the flames of the argument, publications mostly followed his line and style of argument. Accordingly, most of the works originated from historians or those interested in the Holocaust or Jewish history. Kitchens, an archivist at the U.S. Air Force Historical Research Center, commented in 1994 that professional air power historians offered no critique of these arguments, noting

¹⁰⁴ Hilberg, Destruction of the European Jews, Revised and Definitive Edition, vol. 3, p. 1132.

“the Holocaust studies community and that of air power history passed like ships in the night.”¹⁰⁶ Because no professional air power historian provided a critique, Richard Foregger, M.D., World War II veteran, and amateur historian, filled the void. Despite not being a professional historian, he presented a lucid, well documented, and well-organized argument.

In June 1987 he published his “The Bombing of Auschwitz” in Aerospace Historian, stating his purpose as examining the technical feasibility of destroying the extermination facilities.¹⁰⁷ Noting that the earlier historical arguments “are of considerable concern” and taint the War Department and the fighting men, he believed the bombing of Auschwitz “actually might have cost many lives and aircraft and probably would not have stopped the exterminations.”¹⁰⁸ He began by looking at the overall goals of the military commanders--goals defined by the military leaders.

Foregger noted that two War Department decisions defined the use of military assets. Covered earlier in this paper, these included: the War Department’s belief that to bring relief to victims of Nazi oppression quickly meant the speedy defeat of the Axis; and the prohibition on using armed forces for rescue operations unless the operations contribute to the defeat of the enemy’s armed forces. He also noted the directive given to Supreme Allied Commander Dwight D. Eisenhower to “undertake operations aimed at

¹⁰⁵ Ibid.

¹⁰⁶ James H. Kitchens III, “The Bombing of Auschwitz Re-examined,” The Journal of Military History 58 (April 1994): 240.

¹⁰⁷ Richard Foregger, M.D., “The Bombing of Auschwitz,” Aerospace Historian vol. 34, no. 2 (Summer, June 1987): 99.

¹⁰⁸ Ibid.

the heart of Germany and the destruction of her armed forces.”¹⁰⁹ These War Department directives did not allow Eisenhower the latitude to order the bombing of Auschwitz. In addition, Foregger believed that these directives offer valid reasons for not bombing Auschwitz. He then directs his attention to the technical problems of bombing.

Referring to earlier historians’ statements of Allied air supremacy over Europe, Foregger offers primary-source evidence to the contrary. Maintaining that the Allies still held the Luftwaffe in high regard, he quoted the official history of the USAAF which stated that the Luftwaffe in the autumn of 1944 “was more formidable, confident, and aggressive” than in February 1944. He described the losses of Allied aircraft between 6 June and 31 August 1944 as 4,101 aircraft and 16,714 crewmen lost out of nearly one-half million sorties.¹¹⁰

He then turned to the flying distances and the use of Soviet airfields. Adding to earlier revelations, Foregger described how Soviet authorities limited the number of servicemen assigned to the airfields, controlled the flight corridors, and controlled quantity and type of navigational aids available. Shortly after the USAAF began using Poltava, the Luftwaffe attacked it, damaging or destroying 60 B-17s and virtually all of the stockpiled fuel, ammunition, and supplies. Citing 15th AF sources, Foregger noted that 15th AF in Italy suffered from “considerably higher loss ratio[s]” than the 8th

¹⁰⁹ Ibid.

¹¹⁰ Ibid, p. 100.

Air Force operating from England.¹¹¹ Concerning the selection of targets, Foregger covered new ground by describing the air commanders' operations and procedures.

Foregger documents how General Carl Spaatz, Commander-in-Chief of U.S. Strategic Air Forces in Europe (USSTAF), and his staff handled the War Department's message about possibly bombing the camps. While assuring Spaatz that the final decision remained up to him, the message stated "[m]ilitary necessity is still the fundamental requirement."¹¹² Spaatz's staff, at his insistence, looked into the matter, but the British Air Staff (one month earlier) recommended to Spaatz not to carry out such bombing. While no documents exist describing what Spaatz's headquarters staff researched, Foregger noted possible reasons why they rejected the missions.

Air commanders, finally seeing the possibility of attaining the goal of independent air forces, did not want to undertake missions that might put this goal in jeopardy. Also, Foregger noted how theater commanders—including air commanders—retained operational control over their forces since their geographic position and first-hand knowledge offered them the best perspective on possible courses of action. He offered evidence of theater air commanders' deciding to delay or cancel political bombing requests due to their knowledge, experience, and design for past and on-going air operations. One of the examples he offered as evidence was the air support missions to aid the Warsaw Uprisings (cited in earlier works to prove that air forces did participate in rescue operations). Air Marshal Sir John Slessor, Commander-in-Chief of RAF

¹¹¹ Ibid.

Mediterranean Air Forces, countermanded the initial orders because he believed the mission would result in a disaster. However, when pressed by the Air Ministry, the Air Staff, and Winston Churchill, he proceeded. Most of the aircraft did not make the full trip, many dropped supplies that ended up in Nazi hands, and 39 of 181 aircraft did not return, leading to a loss of 200 airmen.¹¹³

Regarding the railway bombing proposals, Foregger offered evidence to support Wyman's notions concerning the difficulty of halting rail traffic. He mentioned multiple instances where labor work-forces of 8,000-12,000-men repair crews repaired one damaged yard. He also said railways did not receive the top bombing priority until May 1945.¹¹⁴

In the remainder of the article, Foregger discussed the planning and technical problems of bombing the camps. He noted that the reconnaissance photos found and annotated in 1979 by the CIA used techniques unavailable in 1944. Brugioni and Poirier said as much when they published the photographs, and noted how World War II photo-interpreters could not see details bought-out by modern methods.¹¹⁵ Like Gilbert, Foregger believed intelligence personnel of the day looked at the photographs for a specific purpose (pre- and post-mission planning of the area's industrial targets) and held no knowledge of the camps and their operations. Countering Gilbert, Foregger analyzed the intelligence problem created by other evidence available at the time.

¹¹² National Archives, RG 165, OPD 383.7, Box 26, Sec. 2, 4 October 1944, as quoted in Foregger, p. 101.

¹¹³ *Ibid.*, p. 102.

¹¹⁴ *Ibid.*

¹¹⁵ Brugioni and Poirier as quoted in Foregger, p. 104.

Foregger believed that matching other information, including the escapee reports, caused additional problems for any bombing preparations because of inaccuracies and inconsistencies. Foregger cited the 6 July 1944 WRB telegram describing the four crematoria as being on the northeast side of the camp. The corresponding maps (drawn by an architect) did not arrive until 7 November, when bombing proved no longer necessary. Even then, the map orientation did not show directions, and the use of conventional reasoning (top-north, right-east) would mean reversing the actual location of the crematoria. Due to alterations, copies, and translations, the maps (in different forms) contained other errors in placement, position, and lacked topographical features including the River Sola, and the rail-spur leading into the camp.¹¹⁶ The spur was almost complete when the escapees Vrba and Wetzler left in April, and two other escapees, Czeslaw Mordowicz and Arnost Rosin, said the rail spur was completed in May 1944. Due to inaccuracies, Foregger claims, the Allies could not accurately plan bombing missions. The British usually prepared Plaster of Paris models to show the aviators relative size, shape and locations of features as they appear when approaching the target. Due to map inaccuracies, the British could not have built a viable model.¹¹⁷

Finally, Foregger covered bombing accuracy. Strategic Bombing Survey figures from industrial bombing showed that only one out of twenty-nine bombs hit essential structures, and out of 100 bombs dropped, 87 missed the target entirely. A separate study concluded that against small targets the RAF managed only 3.03 bomb hits per acre

¹¹⁶ Foregger, pp. 105-106.

¹¹⁷ Ibid, p. 108.

per 1,000 bombs. An intelligence report in one USAAF command showed that at most 17 percent--and often as little as zero or one percent--of bombs against a precise target hit within 3,000 feet. In countering the example of the Mosquito raid against Amiens, Foregger brought-up how the British used detailed planning with valid maps and the Plaster of Paris model. Without such aids for Auschwitz, he again claimed any operation would meet with failure. He also noted another study of precision bombing attempts which concluded that the effects were costly and largely ineffective.¹¹⁸ In the end, Foregger concluded that the Allies did not engage in rescue efforts "because they were determined to devote all their resources to winning the war, and any other efforts would have detracted from that goal. . . .and may have changed the outcome of the war."¹¹⁹

In the same year Foregger published his article, 1987, Michael R. Marrus published an historiography of the Holocaust, The Holocaust in History. He devoted only a few pages to the bombing debate, summarizing the positions of Gilbert, Wyman, and Wasserstein. However, he did bring up two important points. First he put the issue into historical perspective asserting, "present-day discussions about the likely practical efficacy of the bombing of Auschwitz is, in strict historical terms, beside the point, since what matters for the evaluation of this episode is what contemporaries thought about it and why."¹²⁰ He also counters the argument that bombing could have saved Jewish lives (he specifically addressed himself to Wyman) by quoting Albert Speer. Speer told Israeli

¹¹⁸ Ibid, pp. 109-109.

¹¹⁹ Ibid, p. 109.

¹²⁰ Michael R. Marrus, The Holocaust in History (New York: Meridian, 1987), p. 244 (see endnote 22).

political scientist Shlomo Aronson that Hitler's likely response to bombing would not have been to halt such operations, but to accelerate them.¹²¹

The final publication of this period appeared in June 1988. Two responses to Foregger's work appeared in Aerospace Historian. The first came from former USAAF pilot Robert H. Hodges. His main point blasted Foregger for his failure to include information on Mosquito capabilities. He believed the Mosquitoes could accurately bomb the camps. He described other Mosquito precision raids: the aforementioned Amiens raid; a low-level, cross-sea 25 September 1942 attack on the Gestapo headquarters in Oslo, Norway; an extraordinary, low-altitude raid against the Gestapo Zentral in the Kleizkamp Art Galleries of The Hague on 11 April 1944; and the 31 October 1944 bombing of Gestapo Headquarters at Aarhus University on the Dutch peninsula of Jutland. The latter involved flying at extremely low-level over a 1,200 mile round-trip flight.¹²² Hodges made other slight objections to Foregger's article, but his evidence regarding the Mosquito capabilities offered the most enlightenment.

Printed immediately after Hodges' letter was one from a geology graduate student, Michael G. Moskow. Moskow's argument centered on an alleged contextual misrepresentation of evidence by Foregger. For instance, Moskow stated that Foregger used one set of bombing accuracy figures from B-29 aircraft flying in the Pacific Theater.¹²³ While true, Moskow failed to realize bombing accuracy depended on the

¹²¹ Ibid.

¹²² Robert H. Hodges, "The Bombing of Auschwitz: A Clarification," Aerospace Historian, vol 35, no. 2 (Summer, June 1988): 124.

¹²³ Michael G. Moskow, "The Bombing of Auschwitz: A Reply," Aerospace Historian, vol 35, no. 2 (Summer, June 1988): 128.

bombs and aiming devices and not the delivery platform. The B-29's flying characteristics (including payload, altitude, speeds, and range) differed from the B-17's and B-25's. However, all bombers used the same type of weapons and aiming devices—and it is these factors that determine bombing accuracy. While passionately argued and partially documented, Moskow's effort did not contain information of scholarly value.

Thus, the "intermediate" period of the debate closed. The most important work on the debate during these years became Gilbert's book. Also, while the first counter-shot from a writer with expertise in air power came from Foregger, the debate still lacked a contribution from a professional aerospace historian (this would not occur until 1994). Still, the topic remained debated and 1990 witnessed a flurry of writing.

1990: THE DEBATE BOILS

Holocaust historian Leni Yahil published the only prominent book in 1990 addressing the bombing controversy, The Holocaust: The Fate of European Jewry, 1932-1945. The book became widely used and respected. However, the discussion of the bombing debate covered less than two pages as part of the final chapter, "Rescue on the Brink." The brief mention included seven footnotes--six of them referring to Martin Gilbert and David Wyman. Yahil's entry briefly summarized and endorsed these author's theses.¹²⁴

¹²⁴ Leni Yahil, The Holocaust: The Fate of European Jewry, 1932-1945, trans. Ina Friedman and Haya Galai (New York: Oxford University Press, 1990), pp. 638-639.

Richard Foregger published another article in 1990, this time in the journal Holocaust and Genocide Studies. His article, “ ‘The Western Allies and the Holocaust’: Technical Analysis of the Methods to Bomb the Gas Chambers at Auschwitz,” presented a detailed, almost scientific, study of the target and means and methods of bombing. Foregger stated that the paper intended to study only the technical methods and possibilities of bombing. For the purpose of his presentation, he worked from the assumption that the operation would have the full cooperation of civilian and military authorities authorizing the bombing, and almost perfect intelligence information. The intelligence requirements (also assumed to be complete and accurate) included the exact location and orientation of the camps and the precise location and function of all targets within the camps. Target characteristics and susceptibility to material damage (these would include building design and percentage of the structure above ground, construction techniques, construction materials, spacing between targets, and building contents) would also have to be known.¹²⁵

Using information not known to planners in 1944, Foregger detailed the camps’ layout and construction. Using this information, he selected the available weapons to achieve the desired effect (termed “weaponeering” today), and selected the air route to achieve the best bombing effects while limiting damage to non-targets (collateral damage). His route planning also included take-off and landing sites, and in-bound and

¹²⁵ Richard Foregger, “ ‘The Western Allies and the Holocaust’: Technical Analysis of the Methods to Bomb the Gas Chambers at Auschwitz,” Holocaust and Genocide Studies, vol. 5, no. 4, (1990): 403.

out-bound routing to minimize German defenses (for this he used 1944 15th AF intelligence reports presented for the oil bombing missions near Auschwitz).¹²⁶

With this planning information, Foregger then analyzed bombing using the available techniques: formation bombing (the most widely used and preferred method in World War II); dive bombing; and low-level attacks. Using the weaponeering methods, he determined that 500lb-bombs dropped from 20,000 feet in formation bombing would achieve a 64 percent success against KII (crematorium II at Birkenau) using 400 bombs. Since one B-17 or B-24 carried ten 500lb-bombs, the effort against one facility would require forty bombers. Crematorium IV (KIV), being smaller, required 400 bombs for a 60 percent probability of a hit. Thus, to attack the facilities with between a 60 and 64 percent chance of success would require eighty bombers dropping 800 bombs.¹²⁷

Foregger also quoted the analysis of weapons analyst P. M. Sprey. Sprey, in the 1983 Mintz article quoted earlier, estimated that 135 bombers delivering 1,350 bombs would destroy half of the targets in the compound. Of these bombs, he believed around one-third would hit the prisoner barracks area; bombs would fall in the railroad spur-delivery area (killing any Jews arriving and awaiting processing); and bombs would fall on the storage warehouse area where prisoners worked (often called "Canada").¹²⁸ In order to cover all four facilities, Foregger elaborated on Sprey's calculations and estimated the attack would require a larger number of bombs, but "probably less than 2,700."¹²⁹

¹²⁶ Ibid, pp. 403-405.

¹²⁷ Ibid, pp. 407-409.

¹²⁸ Mintz, p. D2.

¹²⁹ Foregger, "Technical Analysis," p. 408.

His weaponeering figures require examination (and Chapter Two will do so). At his point, the question involves his sources for the calculations. He first quotes Major General (Retired) Haywood S. Hansell, Jr.'s The Air Plan That Defeated Hitler. Upon examination, the quoted pages refer to bombing attacks against German electrical power facilities, and use Eighth Air Force data for 1943 and 1944.¹³⁰ As the next chapter will demonstrate, accurately measuring bombing probabilities requires using the specific combat units (Fifteenth Air Force) and specific time frame (July to October 1944). His next source, the War Department's 1945 Handbook for Bombardiers, provides charts, graphs, and mathematical formulas to calculate bombing probabilities.¹³¹ These figures require multiple and specific numeric entries, and Foregger never provides the numbers he used to obtain his statistics. Although they could represent accurate calculations, by not presenting his raw data, the final numbers rest under a cloud of obscurity.

Foregger then added a study of probable bomber losses using a comparison with the attacks on the I.G. Farben plant. He concluded such a mission would lose almost eight percent of the attacking force, achieve only a 60 percent chance of success, and with probable decimation of the prisoner barracks. Saying formation bombing "is definitely not acceptable" he then looked at the alternatives.¹³²

Building upon the earlier statistics, Foregger believed that the probability for collateral damage remained, but at a much higher cost in aircraft and crews. He noted several studies identified losses for dive bombers in World War II as being the highest

¹³⁰ Haywood S. Hansell, Jr., The Air Plan That Defeated Hitler (Atlanta, Georgia: Higgins-McArthur/Longino & Porter, Inc., 1972), pp. 289-293.

among bombers (15-30 percent). Foregger quoted losses against the Ploesti oil facilities in Romania as an example of flight profile and attack required against Auschwitz. Using P-38s, the attacking force lost over 50 percent of its aircraft (24 out of 46).¹³³

Foregger then analyzed the low-level attack profile. In an obvious response to Hodges' 1988 article touting the RAF Mosquito, he quoted results of the Mosquito bombing attacks, and he went even further. He quoted "one of the greatest bomber pilots of the war," RAF Group Captain Leonard Cheshire, as saying, "bombing of Auschwitz in 1944, although difficult, was feasible."¹³⁴ However, Cheshire believed the optimal attacking force would include British Avro Lancaster's flying at night (although he did not elaborate further on the method). Foregger also quoted Hodges clarifying his earlier statements, "I previously recommended the use of the British de Havilland Mosquito. . . .The low-level mission to Birkenau could have been nullified on the basis of ground casualties."¹³⁵

Next, Foregger looked at the possibility of bombing the railroads. He noted the study conducted by F. M. Sallagar for RAND on Operation Strangle. The Allies conducted this two-month operation in 1944 to cut-off the flow of men and supplies to Germans in Italy by attacking the railroad system. The Allies cut every railroad in the designated area in at least two places, and afterward averaged 25 cuts per day. The operation averaged 1,352 sorties per day (with a high of 3,000) and totaled over 50,000

¹³¹ U.S. War Department, Technical Manual: Handbook for Bombardiers, 31 March 1945.

¹³² Ibid, p. 409.

¹³³ Ibid.

¹³⁴ Leonard Cheshire, Letters to the Editor, Sunday Telegraph (London), 4 June 1961, as quoted in Foregger, "Technical Analysis," p. 411.

sorties dropping around 26,000 tons of bombs on railways, bridges, viaducts, marshaling yards, tunnels, and roads. Although asserting that this operation disrupted the German war effort, the study showed German records annotating that stores of ammunition and fuel actually increased. The reasons for the increase were attributed to redundant transportation network, German ingenuity in repairs and using alternative routes and the lack of Allied night bombing.¹³⁶ Compared to Italy, Czechoslovakia contained a higher ratio of railroads per 100 square miles before the war's start (no figures shown for Hungary, but the transports to Auschwitz passed through Czechoslovakia).¹³⁷ Other studies by RAND and the U.S. Strategic Bombing survey also noted the difficulty in bombing bridges and interrupting rail traffic.¹³⁸

In his final analysis, Foregger concluded that bombing Auschwitz required more intelligence than was available to the Allies in 1944. Also, the effort would require a large effort and high losses in aircraft, aircrews, and Jewish casualties for only a 60 percent chance of success. Foregger's argument implied support of the military leadership of World War II by showing that any effort to bomb the camp and the railways would not require small numbers of aircraft. The effort could not include a secondary target on a bombing mission to the oil targets, but required a full-scale attack. Without actually writing it in this paper, he concluded that in June 1944 the War Department

¹³⁵ Letter to Foregger, quoted in Foregger, "Technical Analysis," p. 412.

¹³⁶ F.M. Sallagar, Operation Strangle, Italy, Spring 1944: A Case Study of Tactical Air Interdiction, RAND Report, R-851-PR, 1972 as quoted in Foregger, "Technical Analysis," p. 412.

¹³⁷ Foregger, "Technical Analysis," p. 413.

¹³⁸ Foregger, "Technical Analysis," pp. 413-414.

justifiably denied attacking Auschwitz because such attacks would divert necessary air resources.

The spring of 1990 saw a battle between scholars in the Washington Post's editorial section. On 24 March, Sara Bloomfield, responding to Richard Cohen's column ten days earlier on the "appropriateness" of a Holocaust museum on the National Mall briefly mentioned the bombing issue. Bloomfield, then executive director of the U.S. Holocaust Memorial Council, included the refusal to bomb as one piece of evidence to counter Cohen's statement that "the United States was peripheral to the event."¹³⁹ She argued that the Allies did not act to stop Hitler's actions and "fully aware of the murder factories in Poland, failed to act and even declined to bomb the death camps, though the knowledge and the opportunity existed."¹⁴⁰

Two weeks later, James H. Kitchens III, the archivist at the U.S. Air Force Historical Research Center, responded to Bloomfield's letter. While supporting her for "keen insights into the moral obligations of remembrance," he stated she made errors regarding the U.S.'s capability to "derail the Holocaust by aerial bombardment."¹⁴¹ Kitchens believed that she unjustly incriminated the Allies--and especially the USAAF. He offered three points as to why the bombing did not occur. First, he identified the problems of identifying the crematoriums and gas chambers from the other buildings without proper intelligence material. Secondly, Kitchens believed location of the camps

¹³⁹ Richard Cohen quoted in Sara J. Bloomfield, "A Moral Compass to Keep Us on Course," The Washington Post, 24 March 1990, p. A19.

¹⁴⁰ Sara J. Bloomfield, "A Moral Compass to Keep Us on Course," The Washington Post, 24 March 1990, p. A19.

precluded precision bombing. Finally, he supported the accuracy of the military's position that the bombing would divert assets and the best hope to relieve the suffering would require quick destruction of the Third Reich.¹⁴² These arguments followed not only Foregger's earlier articles, but previewed Kitchens's own detailed argument in a 1994 argument in The Journal of Military History.

It took another two weeks for letters to appear in The Washington Post countering Kitchens's letter. The first came from David Wyman. He disputed Kitchens's three points using a brief version of his by now familiar argument. He closed by questioning the third point saying, "[o]ne may ask how much the war would have been prolonged if a few of those 223 bombers had been diverted five miles [from the oil targets] to wipe those scourges on humanity [the camps] from the face of the earth."¹⁴³ A short letter from a Buchenwald prisoner followed Wyman's letter. Bernard Hubert, stated Kitchens, erred by stating the USAAF did not bomb camps. He said attacks on the factories near Buchenwald occurred from January 1944 through April 1945 heavily damaging the camp and killing prisoners.¹⁴⁴ Hubert briefly mentioned that Buchenwald's factories assembled V-1 and V-2 rockets. The bombers targeted the factory, and not the camp.

¹⁴¹ James H. Kitchens III, "Why We Didn't Bomb the Death Camps," The Washington Post, 7 April 1990, p. A17.

¹⁴² Ibid.

¹⁴³ David S. Wyman, "The Camps (Cont'd.)," The Washington Post, 21 April 1990, p. A23.

¹⁴⁴ Bernard Hubert, "The Camps (Cont'd.)," The Washington Post, 21 April 1990, p. A23.

1994 - 1995: THE DEBATE'S FINAL INGREDIENTS

The first publication by a professional airpower historian to the bombing controversy appeared in April 1994. James Kitchens published "The Bombing of Auschwitz Re-examined," and began with a brief examination of the history of the argument since Wyman's 1978 article. While he mentioned other historians (including Gilbert), attacking Wyman's thesis remained his objective. Primarily, Kitchens attacked Wyman's sources and alleged bias:

Taken together Wyman's scholarly interests, research foci, and superficial documentation go far towards explaining the formulation of his bombing thesis. For the historian of refugee policy, the failure to bomb Auschwitz comfortably fits a pattern of prejudice he believes existed before 1941 and persisted in 1944.¹⁴⁵

The remainder of the paper counters Wyman's thesis by amplifying and adding additional evidence to points already mentioned by Foregger, Hodges, and Groban.

Kitchens's writing displayed a great misunderstanding of the argument's literature, and he mischaracterized the debate's historiography. Throughout the article, he presented Wyman's thesis as representing the views of all Holocaust and Jewish scholars. In doing so, he attempted to imply an antagonistic relationship between airpower and Holocaust scholars. Hilberg's, and especially Dawidowicz's, 1985 publications reveal this portrayal as completely inaccurate.

Presenting his argument, Kitchens first discounted the intelligence value of the Vrba-Wetzler report. Mentioning the inaccuracies already noted, he added that the report did not annotate any potential low-level flying hazards or defenses. "In sum," he

¹⁴⁵ James H. Kitchens III, "The Bombing of Auschwitz Re-examined," p. 244.

concluded on this point, “the militarily useful intelligence available to the Allies about Auschwitz came late and was much shakier than Wyman suggests.”¹⁴⁶

Next, Kitchens looked at the technical problems of bombing even if available intelligence existed. He covered the familiar debates over the range for the bombers to cover and the German flak defenses in the area. However, he provided more depth concerning the Nazi air defenses. Kitchens analyzed the German radar warning stations in southern Europe and said German radars could track any medium- to high-altitude aircraft flying out of USAAF bases in Italy. These tracking measures could alert Luftwaffe and ground anti-aircraft units of impending attack. Jagdfliegerführer Balkan in mid-1944 could attack incoming aircraft with a minimum of thirty fighters, and another twenty-five fighters located in Hungary sat along the direct southern line-of-approach to Auschwitz.¹⁴⁷ Kitchens also cited Poland’s weather as being “unusual and its prediction problematical,” and a further impediment to accurate bombing.¹⁴⁸

He also looked at the accuracy of bombing, although without the detail of Foregger’s article. Kitchens wrote that bombs regularly fell up to one or more miles away from the intended targets, and that the most precise bombing by any 8th AF unit occurred on 15 April 1944. On this date, B-24s placed 50 percent of their bombs within a 500 foot radius of the target (a coastal artillery battery in France) using a medium-altitude profile, with no enemy defenses active, and in near-perfect weather. Using predictions

¹⁴⁶ Ibid, p. 249.

¹⁴⁷ Ibid, pp. 249-252.

¹⁴⁸ Ibid, p. 252.

for 15th AF, he believed 25 to 30 percent of their bombs would strike the inmate areas of Auschwitz.¹⁴⁹

Perhaps reacting to Hubert's letter in the 1990 Washington Post, Kitchens detailed the attack on Buchenwald. Identifying the target as a V-2 rocket guidance works and an adjoining armaments factory adjacent to the concentration camp, he conceded that the comparison was "as analogous to Auschwitz as history permits."¹⁵⁰ However, intelligence on the target included precise locations and factory schedules. The operation used 129 B-17s dropping 303 tons of bombs in near perfect weather. While obliterating the target with "much-above-average accuracy," 315 prisoners died and 1,425 received serious to light wounds.¹⁵¹

To counter the assertion that a low-level attack could have worked, Kitchens describes the well-known and disastrous Ploesti raid, and a lesser-known RAF attack on the M.A.N. diesel works at Augsburg. The latter, Kitchens said "bears the closest resemblance to a hypothetical low-level Auschwitz raid of any actual mission of the European air war."¹⁵² The daylight, low-level raid, partially based on intelligence from a prisoner interrogation who provided a sketch-map, occurred on 17 April 1942. The round-trip distance of 1,250 miles represented an almost exact match as the distance from USAAF airfields in Italy to Auschwitz and back with similar terrain. Of twelve bombers launched, only five returned (all damaged), and only eight reached the target, dropping

¹⁴⁹ Ibid, p. 253.

¹⁵⁰ Ibid, p. 254.

¹⁵¹ Ibid.

¹⁵² Ibid, p. 255.

seventeen bombs. Two un-targeted buildings received substantial damage.¹⁵³ He believed that using B-25s would involve the same difficulties and results.

Moving to the low-level proposal using P-38s or Mosquitos, Kitchens again used the Ploesti raid as an example. He asserted that P-38s would sustain high losses (17 percent in Romania) and achieve only “modest success.”¹⁵⁴ The Mosquito question he covered in greater detail. Calling the aircraft’s capabilities “impressive,” he still believed they would fail in a similar mission against Auschwitz. Using the earlier precision uses of the Mosquito, he noted they crossed the North Sea or relatively flat northwestern Europe. Any attack on Auschwitz would require a long round-trip over mountainous terrain. Countering Wyman’s statement of Mosquitos being available in Italy, Kitchens detailed the orders-of-battle, claiming that the version of the planes stationed in Italy could not carry bombs. “Furthermore,” he said, “no Mosquito fighter-bombers were stationed in the Mediterranean in the summer of 1944, and none could be moved.”¹⁵⁵

These arguments for not bombing aside, Kitchens stated that the ability existed to bomb Auschwitz but that one cannot predict its possible impact on the Holocaust. In addition, he believed any attack could occur only once. After the initial attack, the Germans could easily and cheaply deter further ones by use of decoy buildings, barrage

¹⁵³ Ibid, p. 257.

¹⁵⁴ Ibid, pp. 258-259.

¹⁵⁵ Ibid, pp. 260-261.

balloons, smoke pots, and anti-aircraft guns--making an already difficult target almost impossible.¹⁵⁶

In a very weak attempt to provide a constitutional shroud of legitimacy, Kitchens then questioned the legality of such an attack. Citing the Hague Convention of 1907, Article 25 prohibited the attack of undefended "towns, villages, dwellings, or buildings."¹⁵⁷ He also quoted War Department Field Manuals prohibiting bombing undefended localities, with the possible exception of Auschwitz under the rule permitting the bombing if a combatant military force occupies the location.¹⁵⁸ This area of Kitchens's argument must be seen as irrelevant and unnecessary. Here, Kitchens ignores examples such as the British fire-bombing of Dresden, the American fire-bombing of Tokyo, and the nuclear attacks on Hiroshima and Nagasaki. If Allied planners could make arguments for those bombings, they could do so for the bombing of an installation devoted to the extermination of human beings.

Finally, he addressed the moral question saying:

[T]he underlying moral dilemma is as plain today as fifty years ago: Would it be moral to kill a minimum of several hundred internees in trying to save others--with no assurances of success--and if so, what tragic ratio would have been acceptable? Ultimately, this is a philosophical or theological dilemma, not a historical one, and it is not the historian's duty to resolve it.¹⁵⁹

He also quoted former staff intelligence officer and later Supreme Court Justice Lewis F. Powell. Powell served as a staff intelligence officer in the Army Air Forces, and he

¹⁵⁶ Ibid, p. 262.

¹⁵⁷ Department of State, "Laws and Customs of War on Land" (Hague IV), 18 October 1907, Treaties and Other International Agreements of the United States of America, 1776-1949, vol. 1, p. 648 as quoted in Kitchens, "Auschwitz Re-examined," pp. 263-264.

¹⁵⁸ Kitchens, "Auschwitz Re-examined," p. 264.

served under General Spaatz as Chief of Operational Intelligence, USSTAF. Powell was confident that General Spaatz “would have resisted any proposal that *we* [italics Powell’s] kill the Jewish inmates in order temporarily to put an Auschwitz out of operation.”¹⁶⁰

Kitchens concluded that the Allies did not bomb Auschwitz for reasons unrelated to any antisemitism. He believed the Allies did not attempt to bomb the camp but due to unavailability of intelligence, operational constraints, availability of aircraft, rules of war, and conventional morality. His article ends, “Allied leaders made the mistakes all humans do, but the available evidence suggests that avoidance of death camp bombing out of prejudice was not one of them.”¹⁶¹ After Kitchens’s article, nearly a year passed before further publications on the topic.

In March 1995, the World Press Review reprinted David Horovitz’s article from the 12 January 1995 Jerusalem Report. He remarked that many Holocaust historians, analysts, and survivors believe as “almost accepted wisdom” in the ability of Allied bombings to save Jewish lives. He cited the theses of both Wyman and Kitchens, and also a research paper by Richard H. Levy (a retired Seattle engineer). The latter claimed, “treatment of operational aspects of this affair by so-called historians of the Holocaust is pathetic. Many of them leap to the conclusion that the bombing could easily have been done, and then jump straight from this to the view that the failure to do it was politically

¹⁵⁹ Ibid.

¹⁶⁰ Oral History Interview with Lewis F. Powell, 26 February 1985 quoted in Kitchens, “Auschwitz Re-examined,” pp. 264-265.

¹⁶¹ Kitchens, “Auschwitz Re-examined,” p. 266.

motivated.”¹⁶² Horovitz also paraphrased Martin van Creveld, a renowned Hebrew University military historian as saying to stop the killings meant using multiple attacks and assured certain German retaliation.¹⁶³ Horovitz agreed with these views (but not in the extreme manner of Levy).

Horowitz noted that historians overlook how, even in 1944, Jewish opinions on bombing the camps remained divided and oscillatory. “In the half-century that has passed,” he noted, “many people seem to have forgotten that the Jewish appeals for the bombing of Auschwitz were neither convincingly argued nor widely supported.”¹⁶⁴ He concluded by putting the Allied leadership’s point-of-view in context:

One other consideration, easy to overlook 50 years on, is that while we can see that an Allied victory was virtually inevitable by 1944, the strategists of the day had no such assurances. Every bombing raid was potentially crucial, every diversion from the strategic aims potentially catastrophic. It’s easy to talk of anti-Semitism, to deride the single-minded Allied commitment to the speediest possible crushing of the German war machine.¹⁶⁵

Continuing the mid-1990s trend of countering Wyman’s thesis, the next article looked at the accuracy of the Auschwitz-Birkenau sketch maps. Once again Richard Foregger entered the debate. In this instance, he strove not to argue for or against bombing, but only to determine if the two sketch-maps of Auschwitz proved adequate for locating the camps. Foregger briefly noted how the maps came into being and reiterates their errors and inconsistencies. The first map originated from the debriefings of escapees Vrba and Wetzler, Czeslaw Mordiwiez and Arnost Rosin (both escaped on 27

¹⁶² Richard H. Levy, “The Bombing of Auschwitz Revisited--A Critical Analysis,” as quoted in David Horovitz, “Why the Allies Didn’t Bomb Auschwitz,” *World Press Review*, March 1995, p. 44.

¹⁶³ Martin van Creveld as cited in Horovitz, p. 45.

¹⁶⁴ Horovitz, p. 45.

May 1944), and the aforementioned Polish major identified as Jerzy Tabeau.¹⁶⁶ The second map, also drawn from escapee reports, came from the Polish Ministry of the Interior. Using these maps, Foregger stated one could not accurately locate the crematoria and gas chambers. He concluded, “claims that these two particular maps would have enabled Allied bombers to locate and destroy the killing installations are not valid.”¹⁶⁷

Perhaps 1995s most important, and insightful, look at the bombing debate was Edward T. Linenthal’s Preserving Memory: The Struggle to Create America’s Holocaust Museum. The United States Holocaust Memorial Museum opened on 22 April 1993. Included in its exhibits is a large photomural, an enlargement of a 31 May 1944 reconnaissance photo of the Auschwitz area. The accompanying text said Allies could have bombed the camp as early as May. It concluded, “although bombing Auschwitz would have killed many prisoners, it would also have halted the operation of the gas chambers and, ultimately, saved the lives of many more.”¹⁶⁸

Linenthal objected to the use of “would” rather than “might.” He believed this exhibit’s wording, an acceptance of Wyman’s thesis (who was on the Museum’s content committee), kept visitors from fully understanding the ongoing controversy, and made the interpretation a statement of fact. The theme, however, fit into the museum’s narrative of

¹⁶⁵ Ibid.

¹⁶⁶ Richard Foregger, “Two Sketch Maps of the Auschwitz-Birkenau Extermination Camps,” The Journal of Military History 59 (October 1995): 689.

¹⁶⁷ Ibid, p. 696.

¹⁶⁸ Quoted in Edward T. Linenthal, Preserving Memory: The Struggle to Create America’s Holocaust Museum (New York: Viking, 1995), p. 218.

American indifference in other areas, such as the SS St. Louis's voyage and American refusal to accept Jewish refugees.

One other important fact, especially light of Kitchens's view that the debate is defined by "air power versus Holocaust" historians. Linenthal included Kitchens's theses as he presented it as the Smithsonian Institution's National Air and Space Museum's 1993 conference "The Bombing of Auschwitz: Should the Allies have Attempted It?" However, Linenthal also includes critiques of Wyman's argument by prominent Holocaust historians Michael Marrus and Christopher Browning.¹⁶⁹

1995 became the first period analyzed in this paper where only counter-arguments to the Wyman thesis occurred. 1996 opened with Holocaust historians re-assessing the failure of those condemning the Allied governments for inaction to provide adequate historical context.

1996: RE-ASSESSING THE ARGUMENT'S CONTEXT

The most recent work appeared in early 1996, and was a collection of essays, edited by Verne W. Newton, and titled FDR and the Holocaust.¹⁷⁰ The book compiled several of the articles already mentioned with analysis from Holocaust scholars. It included Richard Levy's and Kitchens's articles. Also, the work included two scholars offering detailed criticism of Wyman's thesis, thus destroying Kitchens's characterization of Holocaust scholarship being monolithic in its view of the Allied inaction.

¹⁶⁹ Linenthal, pp. 220-224.

¹⁷⁰ Verne W. Newton, ed., FDR and the Holocaust (New York: St. Martin's Press, 1996).

Henry Feingold believed Wyman's Abandonment suffered from the author's preconceived perception that a "government should want to help people in distress, even when they are citizens of another country, or stateless."¹⁷¹ Feingold believed Wyman became caught up in the passion of his beliefs and misconstrued the context of American government officials and decisions. According to him, the government held no preconceived notions on Jews, "[t]hey did not separate the notion of rescue from the major goal of winning the war as quickly as possible. Their perception of what should and should not be done, therefore, differed radically from Wyman's."¹⁷² Feingold applauded the research, but called the book's historical perspective "strangely disturbing."¹⁷³

Immediately following Feingold's review, Michael Marrus reviewed Wyman's and Penkower's books. Marrus also rebuked both authors for not understanding the context of events in World War II and how Jewish concerns fit into the thinking and actions of Allied governments. He noted how modern historians concentrating on "Holocaust bystanders" immediately tend to condemn without appreciating the attendant conditions. By trying to explain what did not happen, Marrus said they fall into "the historian's form of hubris. . . .to denounce the characters we write about for not being like

¹⁷¹ Henry L. Feingold, "Review of David Wyman's Abandonment of the Jews: America and the Holocaust, 1941-1945," in Newton, p. 146.

¹⁷² Ibid, p. 148.

¹⁷³ Ibid, p. 149.

ourselves.”¹⁷⁴ He added that historians should turn to “explanation rather than condemnation” and pointed out:

I venture to suggest that we shall not go much further in the attempt to comprehend the past without a remorseless, painstaking effort to suspend anger, to try to understand how the people we describe perceived the world and why they acted as they did. When writing about bystanders, such effort is particularly necessary in view of some harsh accusations recently made from a strongly defined political or ideological vantage point. . . . We should avoid the tendency to castigate outsiders without fully understanding them.¹⁷⁵

While such questions and considerations remain necessary, their introduction by fellow Holocaust historians, and not airpower historians like Kitchens and Foregger, carry greater significance.

* * * * *

The argument came full-circle. It began in the 1960s by questioning Allied inaction and then damning such inaction. The debate became defined by David Wyman’s 1978 article and re-printings of his thesis in various books (including his own). The next seventeen years saw massive amounts of evidence supporting and countering Wyman’s thesis. However, the most recent publication contained Holocaust scholars asserting serious questions about the argument—indeed questioning the methods used to study history that did not happen.

¹⁷⁴ Michael R. Marrus, “Bystanders to the Holocaust (Review of Monty Penkower’s The Jews Were Expendable: Free World Diplomacy and the Holocaust and David Wyman’s Abandonment of the Jews: America and the Holocaust, 1941-1945),” in Newton, p. 152.

¹⁷⁵ Ibid.

A thorough and unbiased study of the scholarship on the question of bombing Auschwitz comes to a conclusion, but does not answer all of the individual questions. Undoubtedly, the Allies could have used airpower to bomb the camp and the railroads feeding it. Even though Kitchens and Foregger rightly demonstrated the difficulties and intricacies involved, the opportunity and ability to bomb remained unquestionable. The possibility existed of losing Allied aircraft and killing Jewish prisoners, although those participating in the argument disagreed to their extent. All authors also showed that such bombings involved a diversion of military assets from military and industrial targets. Even Wyman's belief in dropping a few bombs on the way to another target meant that these bombs (regardless of their significance to the military effort or effect on rescue) would not hit a military target. All authors established, to varying degrees, that those involved with the question at the time remained divided among themselves. Different personnel within the British and American governments, and the various Jewish groups, both supported and opposed the bombing of Auschwitz.

Other questions delved into the realm of "what-if" history and must remain pure speculation. Two inter-related questions stand out: What would the German reaction to the bombings have been, and would Jewish lives have been saved? The other important speculation surrounded the diversion of military assets to accomplish the mission. Would such a diversion hamper the war effort? By keeping the assets flying against military targets, did the Allies end the war earlier? By ending the war earlier, were Jewish lives saved? The hardest question remains the moral one. Is killing an undetermined number

of people justifiable to save another unknown number—even if the number of lives saved is higher?

In the end, the answer to these questions would provide the most enlightenment and settle the debate. What remains almost certain is that the debate will continue and scholars and non-scholars alike will persist to speculate on their answers.

CHAPTER TWO

BOMBING THE CAMP: THE MILITARY ASPECTS OF A POSSIBLE ATTACK

David Wyman, Bernard Wasserstein, and the other authors mentioned in Chapter One have provided an in-depth analysis of the political aspects of why the Allies did not take military measures against the Nazi death facilities around Oswiecim, Poland. These authors, however, only skimmed the surface of the capabilities, constraints, and complexities involved had the Allies decided to attack the crematoriums. On the other hand, James Kitchens and Richard Foregger have presented arguments against such an attack while ignoring the fact that despite the difficulties, the Allies could have carried out such an attack if the political will existed to do so. This chapter will attempt to piece together the puzzle of the military's knowledge of Auschwitz's mission, the capabilities of various bombers to bomb the killing facilities, and possibilities of attacking the crematorium.

BOMBING REQUESTS AND GOVERNMENTAL INFORMATION FLOW

Wyman's articles meticulously showed the information flow among the members of the WRB and from the WRB to the War Department. Obviously, both government agencies knew, to some extent, that the Nazis operated concentration camps, took extreme actions against Jews, and had been and were continuing to deport Jews to various

concentration camps—including Auschwitz. However, the bulk of the communications from the WRB to the War Department arrived not to those in charge of making plans or military decisions, but to the Civil Affairs Department (CAD).

Major General J.H. Hilldring directed the CAD in 1944. Throughout 1944, he became active in the communications concerning the bombing requests and Jewish rescue efforts that were exchanged among the WRB, several Jewish agencies, and the War Department. After the WRB's establishment, Jacob Blaustein, Chairman of the American Jewish Committee, offered his organization's services to the WRB.¹ His letter to Henry L. Stimson, the Secretary of War, came to CAD and the desk of Hilldring. Hilldring forwarded the letter to Pehle, and drafted a reply to Blaustein from Stimson for the latter to sign.²

A similar pattern ensued when the CAD received a 20 August 1944 telegram from the Union of Orthodox Rabbis of the United States and Vaad Hotzala Emergency Committee asking the Secretary of War for urgent action to rescue Jews being deported from Hungary.³ The reply to the Jewish organizations was signed by Stimson's Adjutant General, J. A. Ulio, and stated, "the Secretary of War is acutely aware of the plight of these unfortunate people and is desirous of taking all possible measure to improve their condition."⁴ As before, CAD supplied copies of all letters and replies to Pehle. In this instance, Pehle responded back to Hilldring and stated:

In response to similar messages from these organizations to the Secretary of the Treasury and the War Refugee Board, they were advised that this Government has

¹ Letter to Henry L. Stimson, from Jacob Blaustein, 12 February 1944. RG 165, CAD 383.7, NA.

² Cover Letter to Stimson, from Hilldring, 16 February 1944. RG 165, CAD 383.7, NA.

³ Memorandum to Stimson, from Hilldring, 22 August 1944. RG 165, CAD 383.7, NA.

⁴ Letter to Union of Orthodox Rabbis of the United States, from J. A. Ulio, 24 August 1944. RG 165, CAD 383.7, NA.

not yet received confirmation of the report referred to in their telegram and that further information is being sought by this Board. In the meantime, all practicable measures are being continued to protect the lives of Jews in Hungary. . . . They were assured that regardless of the attitude of the Germans, this Government will continue, consistently with the successful prosecution of the war, its unremitting efforts to save the Jews of Hungary.⁵

Neither of the letters contained notations, forwarding information, or indications that any other offices of the War Department received notification of the requests. Hilldring took the standard actions seen in other requests from Jewish groups to the War Department—prepare a standard reply and forward all information to Pehle. Pehle's reply offered no evidence that a further study of the matter had been carried out, or that the planning and operations sections of the War Department had been asked to study the feasibility of carrying out any operations to save the Jews of Hungary. As Wyman has detailed, any requests to the War Department's Operations Division (OPD) contained the same response, noting the of impracticality of bombing due to military necessity and diversion of air resources.⁶

The troubling aspect of these communications, and OPD's responses, is that no requests were made to the prominent Army Air Force leaders on the feasibility or possibility of attacking Auschwitz until October 1944 (as will be seen below, this was too late to save the Hungarian Jews and weather would have precluded accurate bombing). In the personal and official diaries and communications of Generals Henry H. Arnold, Carl Spaatz, Ira C. Eaker, James H. Doolittle, and Nathan F. Twining, nothing indicates that they were tasked to study or comment on attacking the camp by OPD or the WRB until October, although both said earlier in the year that such attacks could not be conducted.

⁵ Letter to Hilldring, from Pehle, 4 September 1944. RG 165, CAD 383.7, NA.

Despite the seeming lack of an official request from civilian authorities to take action, the USAAF leaders knew of the earlier bombing requests.

On 13 June 1944 General Henry H. Arnold, Chief of the USAAF, cabled Lt. General Carl Spaatz, who led the United States Strategic Air Forces in Europe (USSTAF). Spaatz commanded all U.S. strategic bomber forces in Europe, then divided into the Eighth Air Force (8th AF) in England and the Fifteenth Air Force (15th AF) in Italy. The message from Arnold (only three lines long) did not request any action, and only stated that the Polish Consul and Minister requested bombardment of the "Kaschau-Preshovto" railroad to "preclude abduction by Germans of hundreds of thousands of Hebrews from Hungary."⁷ Furthermore, Arnold noted the information came from the Military Attaché in Switzerland.

Five other broken and limited pieces of information appear in Spaatz's records. First, a letter dated 6 September 1944 from Air Vice-Marshal Norman Bottomley, RAF Assistant Chief of the Air Staff (Operations), referred to a previous discussion between him and Spaatz on "the possibility of bombing objectives in Upper Silesia as a result of representations made by certain Jewish associations as to the mass murder of Hungarian Jews, which was alleged to be taking place in that area."⁸ Bottomley went on to say that his information from the British Foreign Office stated that the deportations had ceased and "because of the serious technical difficulties of carrying out bombing they do not propose to pursue the matter further. . . and I suggest that you do not consider the project any

⁶ See Wyman, *The Abandonment of the Jews*, pp. 291-297.

⁷ Message to Spaatz, from Arnold, 13 June 1944. Carl Spaatz Collection, Box 139, Occupied Countries, LOC Manuscript Division.

⁸ Letter to Spaatz, from Norman Bottomley, 6 September 1944, Carl Spaatz Collection, Box 16, Personal Diaries, LOC Manuscript Division.

further.”⁹ Spaatz’s collection of official and personal correspondences contained no information of any previous discussions on this matter.

The second mention in Spaatz’s records came from the United States Embassy in London. The letter, from Fred K. Salter to Spaatz’s Deputy Commander of Operations, Maj. General Fred L. Anderson, was a cover letter for a message Anderson had requested. The message came from the British Embassy’s WRB representative, James Mann, to Pehle.¹⁰ The WRB message, dated 29 September 1944, contained information supplied to Mann by the Polish government. According to Mann, the Polish underground had informed Polish officials in England that the Germans continued to increase “extermination activities” in Poland, and urged the WRB “to explore again with the Army the possibility of bombing the extermination chambers and German barracks at the largest Polish concentration camp which, they state, are detached sufficiently from the concentration camps to allow precision bombing to be done.”¹¹ Mann went on to state, “It is my assumption that the army authorities have maps of such camps” and if not, the Polish underground promised to furnish them.¹² As with the earlier messages, Spaatz’s records provided no other information regarding why Anderson made the request for the information.

The third reference to the camp facilities at Auschwitz also came from the U.S. Embassy in London. J. D. Beam, the Second Secretary of Embassy, at the request of John G. Winant, the U.S. Ambassador to Great Britain, sent Anderson copies of several

⁹ *Ibid.*

¹⁰ Letter to Anderson, from Salter, 5 October 1944, Carl Spaatz Collection, Box 139, Occupied Countries, LOC Manuscript Division.

¹¹ Paraphrase of message to Pehle from Mann, 29 September 1944, Carl Spaatz Collection, Box 139, Occupied Countries, LOC Manuscript Division.

telegrams received by the Embassy from the Polish Government. The enclosure contained five telegrams sent by an RAF officer in Warsaw. The first three telegrams detailed problems of famine, disease, and the military situation surrounding the city. However, the final two, dated 25 and 26 September 1944 discussed the camps at Auschwitz and Buchenwald. According to telegraph four, "the Germans intend to completely liquidate the internment camps at Oswiecim and at Buchenwald" and the commandant (no reference to which camp) had requested extra military personnel and equipment to carry out the action. The message also stated that "there are 16, 727 men and 39,125 women prisoners at [Birkenau] whilst the figure for Oswiecim and Buchenwald must be near the hundred thousand mark. It is feared that [the] Germans will carry out this massacre and try to throw the blame on Allied bombers."¹³ The final telegram from Ward indicated that prisoners from Oswiecim and Buchenwald had smuggled messages to Warsaw asking for help because camp guards had told them of an impending massacre.¹⁴ As with all other messages, no other documentation existed in the files to show why the USSTAF received these messages or whether the headquarters made use of this information for planning purposes.

The final two references, the only records indicating that the air leaders commented on Auschwitz bombing proposals, were 4 and 5 October messages to Spaatz. The first, from Arnold, referred to the September messages from Winant and says, "this is entirely your affair. We have not, repeat not, [verified] military necessity as [fundamental]

¹² Ibid.

¹³ Telegram No. 4 from J. Ward, included in letter to Anderson from Beam, 27 September 1944, Carl Spaatz Collection, Box 139, Occupied Countries, LOC Manuscript Division.

¹⁴ Telegram No. 5 from J. Ward, included in letter to Anderson from Beam, 27 September 1944, Carl Spaatz Collection, Box 139, Occupied Countries, LOC Manuscript Division.

requirement in our view.”¹⁵ The next day, Anderson cabled Spaatz that a request to bomb the extermination chambers “be exploited,” but he was concerned about bombs killing prisoners, and the Germans use of this as an alibi “for any wholesale massacre.”¹⁶ These statements indicated that this was the first time Anderson had seen any such request, and that he did not understand the true functions of Auschwitz. He also stated that while he found the situation for “Poles” interned there as unfortunate, he recommended “no encouragement be given to this project.”¹⁷ The records revealed no references to Spaatz’s responses or actions.

If the WRB and OPD had seriously studied the possibility of attacking Auschwitz, or rail lines leading to it from Hungary, during the spring and summer of 1944, it is reasonable to assume that these requests and studies would be in the records of USAAF leaders during that time. No such records of this type exist in the above mentioned generals’ official or personal collections until very late, and these were less a request for planning proposals and more an afterthought for information purposes only. At the very least, a serious inquiry into an important operation using air power would have reached Arnold. In addition, it is also reasonable to assume that Arnold would have at least approached his theater commanders to ask their opinion, and to request information for the plausibility of such attacks, available resources, resources necessary for such an attack, and chances of success. Arnold remained in constant contact with the air commanders in Europe—especially with Spaatz—because of the latter’s direction of the largest and most

¹⁵ Message to Spaatz, from Arnold, 4 October 1944, Carl Spaatz Collection, Box 19, as printed in David Wyman, ed., *America and the Holocaust*, 13 vols. (New York: Garland Publishing, Inc., 1990), vol. 12: *Bombing Auschwitz and the Auschwitz Escapees’ Reports*, p. 173.

¹⁶ Message to Spaatz, from Anderson, 5 October 1944, Carl Spaatz Collection, Box 37, as printed in Wyman, *Bombing Auschwitz and the Auschwitz Escapees’ Reports*, p. 174.

important campaign in the young history of U.S. air forces, the Combined Bomber Offensive. The belated information given on 4 October (as opposed to a serious request for planning action) demonstrated the lack of impetus behind the request from military and political leaders above Arnold. Compared to the initial planning for the airdrop operations to Warsaw, where the political will drove military leaders to accept the mission and discussions carried-out by cable demonstrated earnest planning efforts, the bombing proposals displayed a lack of urgency.

Polish forces, led by General Tadeusz Bór-Komorowski, rose against the Nazi forces in Warsaw on 1 August 1944. Bór, and Polish authorities in London, acted on perceived authentic radio orders from Moscow. With the Red Army closing in on the Polish capital, the besieged patriot force counted on the Soviets arriving to aid them. Without explanation, the Red Army halted its drive only 10 kilometers (6.2 miles) from Warsaw.¹⁸ The Polish army, trapped in the city and facing a still powerful German force, fought bravely, but with continually dwindling supplies. With the personal attention of Winston Churchill and President Roosevelt, Allied Air Forces attempted to aid the Poles by air-dropping supplies.

General Dwight D. Eisenhower received a 15 August message from Washington urging such military assistance.¹⁹ However, USAAF leaders pondered the mission prior to Washington's message to Eisenhower. Eaker, then commanding the Mediterranean Allied Air Forces (MAAF), sent a personal message to Arnold on 13 August recommending

¹⁷ Ibid.

¹⁸ Authur Bliss Lane, I Saw Poland Betrayed: An American Ambassador Reports to the American People (Indianapolis: Bobbs-Merril Co., 1948), pp. 42-44.

against such an effort, and asserted that he had “made a complete restudy” with Twining, commander of 15th AF. He also claimed that he could not spare the bombers. Eaker went on to suggest “it is definitely and completely agreed here that it is an impractical operation. . . . May I urge that you present this view to [the Combined Chiefs of Staff] most strongly and thus avoid heavy losses and the poor execution of an operationally inadvisable mission.”²⁰ Having already studied the situation, Spaatz sent a message to Arnold recommending using Eighth AF. However, he noted the operation “is being carefully analyzed to determine what casualties we must expect,” and he suggested the proper altitude at which to fly to accurately drop the supplies.²¹ The same day, Spaatz sent a message to Major Generals Robert J. Walsh and John R. Deane. Walsh commanded USSTAF’s Eastern Command, the air bases in the Soviet Union used for FRANTIC missions, and Deane led the U.S. military mission in Moscow. Spaatz proposed using FRANTIC missions, comprised of seventy bombers and one hundred fighters, to drop supplies and bomb a Nazi airfield in the Warsaw vicinity on 15 or 16 August. He wanted Walsh and Deane to clear the mission with the Soviets and have them pick the airfield target. Spaatz urged quick action and said, “highest authorities are interested.”²²

¹⁹ Wesley F. Craven and James L. Cate, eds., The Army Air Forces in World War II, 7 vols. (Chicago: The University of Chicago Press, 1949), vol. 3: Europe: Argument to V-E Day, January 1944 to May 1945, p. 316.

²⁰ Message to Arnold, from Eaker, 13 August 1944. Ira Eaker Collection, Box 22, Correspondences with General Henry H. Arnold, Vol 2, 1 May 1944 - 31 August 1944, LOC Manuscript Division.

²¹ Message to Arnold, from Spaatz, 13 August 1944. Carl Spaatz Collection, Box 18, Official Diary, LOC Manuscript Division.

²² Message to Walsh and Deane, from Spaatz, 13 August 1944. Carl Spaatz Collection, Box 18, Official Diary, LOC Manuscript Division.

At both the political and military levels, Britain and the U.S. could not gain Soviet agreement to the proposal. Two days after Spaatz's message to him, Deane replied that the Soviet Foreign Office denied using FRANTIC missions and "firmly restated the Soviet position."²³ American and British government officials continued to protest to the Soviets, and their persistence paid off. On 11 September, the Soviets gave approval to drop supplies, and, as an act of concession, even participated on 13 September.²⁴ Still, Soviet intentions may not have been whole-hearted, as Ward reported on 26 September that the Soviets dropped only small quantities of "gruel and biscuits [sic]." In addition, the Poles could not use these because the Soviets did not use parachutes.²⁵

Eighth AF carried out the last FRANTIC mission on 18 September, and used 107 B-17s to drop 1, 284 containers of weapons, food, and medicine. Despite initial indications of success, it later became known that the maximum number of containers reaching the Poles numbered 288 at most, and possibly only 130. The remainder fell into Nazi hands.²⁶ The Polish premier-in-exile, Stanislaus Mikolajczyk, appealed to Churchill for further drops. Churchill telephoned USSTAF to ask for the missions, and Roosevelt ordered more airdrops. The War Department and air staffs both regarded further missions as costly and hopeless, but due to the political leadership's insistence, they were prepared to carry them out. Only the refusal of the Soviet government to allow further missions

²³ Message to Spaatz and Walsh, from Deane, 15 August 1944. Carl Spaatz Collection, Box 18, Official Diary, LOC Manuscript Division

²⁴ Craven and Cate, vol. 3: Europe: Argument to V-E Day, pp. 316-317.

²⁵ Telegram No. 1 from J. Ward, included in letter to Anderson from Beam, 26 September 1944, Carl Spaatz Collection, Box 139, Occupied Countries, LOC Manuscript Division.

²⁶ Craven and Cate, vol. 3: Europe: Argument to V-E Day, p. 317.

kept the planes grounded.²⁷ The Nazis quashed the Polish rebellion in early October, and the Red Army took the city in January 1945.

The use of FRANTIC missions and the debate over dropping supplies offers valuable insight into the possibility of bombing Auschwitz. Allied forces carried out the Warsaw relief missions at the insistence and personal intervention of Churchill and Roosevelt. The air force leaders acted quickly to ready themselves and sent multiple messages between the commanders of the forces involved to inquire about necessary types of aircraft, numbers of aircraft, and the optimum altitudes for the mission. Even when some War Department officials expressed disapproval, the missions took place. Only political intervention kept the Allies from flying additional relief missions.

If Churchill and Roosevelt had been as adamant about bombing Auschwitz as they were about supplying the Warsaw patriots, undoubtedly the missions would have flown—despite the objections of the War Department. Still, the accuracy of the War Department's statements concerning a diversion of assets prompts examination. Assuming that the Allied leaders applied the necessary political will, the planning and bombing of the crematorium would have required significant resources and efforts.

INTELLIGENCE AND PLANNING

Before assessing what information the planners required, one must examine the information available to the air commanders during the summer of 1944. From 1942 to mid-1944, Allied governments' information on Nazi concentration camps remained fragmentary and unconfirmed. Information relating to Oswiecim centered on the I.G.

²⁷ Ibid.

Farben industrial facility, and made little reference to the camps. Also, even when intelligence sources mentioned the presence of camps, they continually referred to them as prisoner-of-war (PW or POW) or labor camps. These references indicated that Allied intelligence did not, until 1944, know the true functions of these facilities.

Figure 1: Oswiecim Area and Auschwitz Main Camp Locations

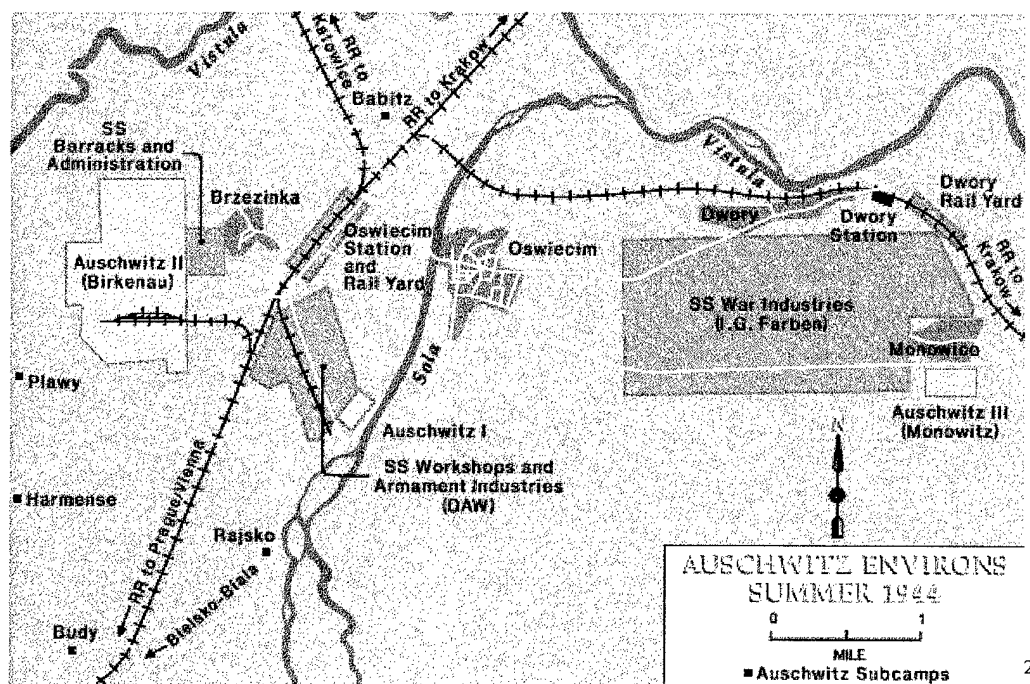

One of the earliest available official reports on Oswiecim came from the Office of Strategic Services (OSS), the forerunner of the Central Intelligence Agency. The short report, dated 25 August 1942, recorded the number of inmates for Oswiecim at 15,000 and describes them as “mostly intellectuals and middle class elements.”²⁹ The report did

²⁸ Martin Gilbert, *Atlas of the Holocaust* (New York: Pergamon Press, 1988), p. 93.

²⁹ Office of Strategic Services, no title, numbered as 09468, Copy contained in USHRI Subject File: Camps - Auschwitz.

mention inmate turnover as being "very great" and two Polish workers being executed. A separate report, dated 15 October 1943, provided in-depth information on the synthetic oil and rubber works in the vicinity of Oswiecim. As intricate as the information is on the plant, very little data existed on the nearby camps. The reference stated:

Labour for the new factories is German and foreign, and one source is the great concentration camp of 65,000 people near the town, the group includes 32,000 Jews from Poland, France, Belgium and Jugoslavia, and they are worked in groups of 100, each group under a Kommandant. The camp is highly protected and fortified under the eyes of 2200 SS men. Many of the prisoners are political.³⁰

Intelligence information on-hand in Europe available to flight crews contained much the same information as the 1943 OSS report. However, the Target Information Sheet for the I.G. Farben Complex, used for planning bombing missions, made no mention of the camps (as of 18 July 1944).³¹ The file did contain a separate amendment, dated 21 September 1944, covering the labor camp area (Auschwitz III or Monowitz). It provided a grid reference to locate the camp and said, "[it] is now known to be used as a Prisoner of War Camp."³² The file also included the reconnaissance photos taken on 4 April 1944 by U.S. aircraft (discussed in Chapter One), and a map used by aircrews to show distance and magnetic headings as they approach the target.

³⁰ OSS Report, 15 October 1943. Copy contained in USHRI Subject File: Camps - Auschwitz.

³¹ "Oswiecim Synthetic Oil and Rubber Work, Poland," Target Information, USAFHRA File Number 670.424.

³² Ibid.

Figure 2: Reconnaissance Photos of Oswiecim Synthetic Oil Plant³³

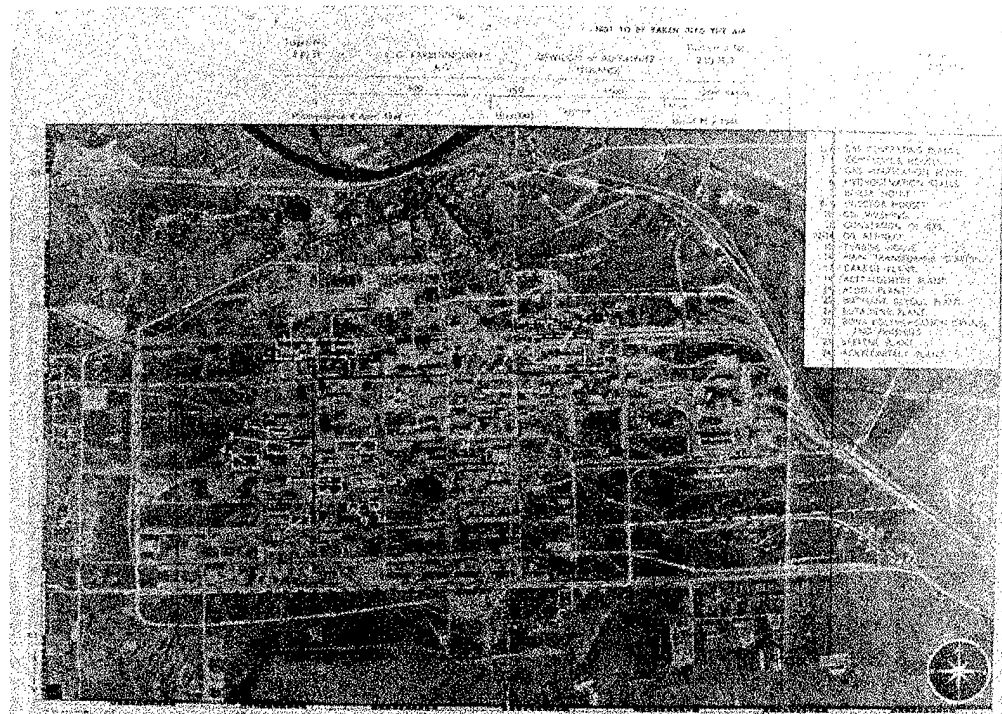
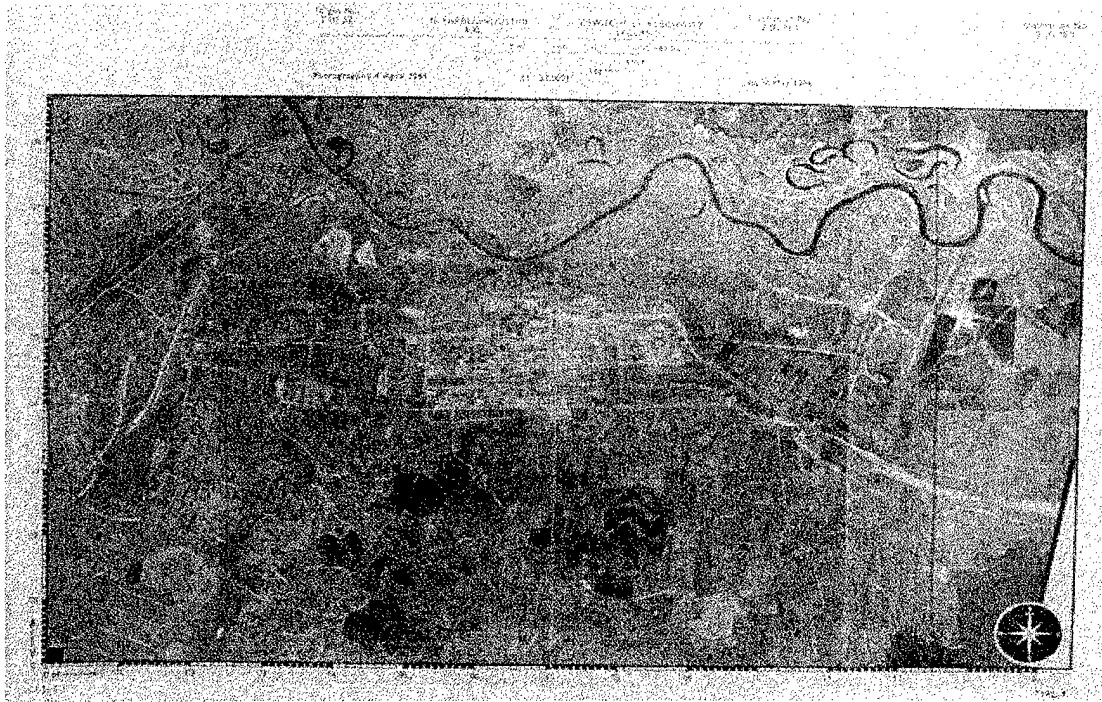

³³ Ibid.

Figure 3: Close-up of Auschwitz III-Monowitz³⁴

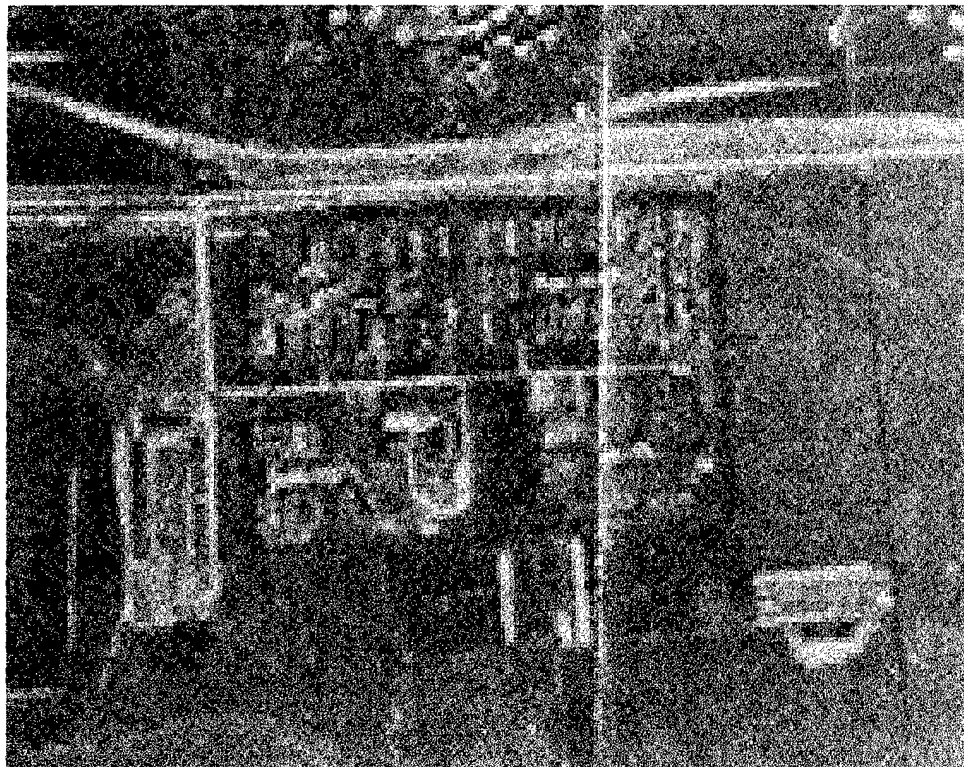

³⁴ Ibid.

Figure 4: Target Map for I.G. Farben Facility³⁵

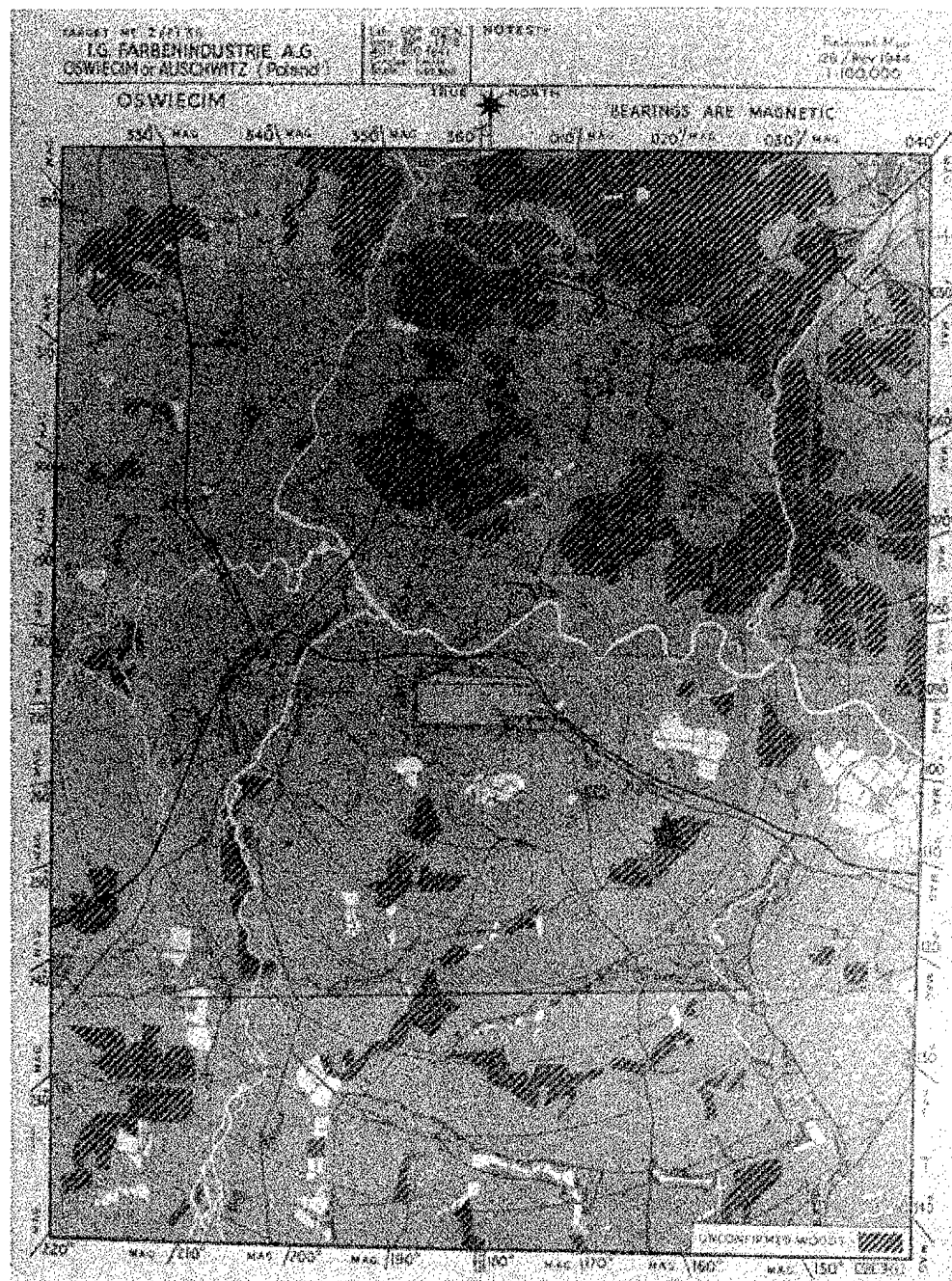

³⁵ Ibid.

The most significant intelligence, the escapees' reports, came to the WRB in July 1944. The WRB representative in Switzerland, McClelland, sent two messages to Washington, one to the State Department and one to the War Department (annotated "for the WRB"). Although dated 6 July, the messages arrived at their separate destinations on 8 July and 16 July, respectively (according to the stamps on the original messages). Together, they supplied the information on Auschwitz I and Birkenau (Auschwitz II) from the separate escapee reports of the Slovakian Jews, Vrba and Wetzler, and the Polish officer (see Chapter One). As the first message indicated, these reports do not include hearsay, but "actual personal experiences." In addition, McClelland wrote, "Their authenticity seems corroborated by fragmentary reports from different individuals and organizations in Switzerland which have come in the last two years, and particularly as to the composition of transports of Jewish deportees coming from everywhere in Europe."³⁶ The second message, a summation of all three escapees' reports, provided details on the layout, functions, and operations of both Auschwitz I (the main camp) and Birkenau.³⁷

Historians disagree on the actual arrival date of the complete reports to the necessary authorities. In any case, the arrival stamp on the messages displays the dates mentioned above. Therefore, had the political force been behind an effort to bomb the camp, military planners should have been able to access the information from these messages not later than 18 July. Still, as Foregger and Kitchens both wrote, these messages contained only a summation of the report, and not the actual reports themselves.

³⁶ Message to WRB from McClelland, Number 4291, 6 July 1944. Copy contained in USHRI Subject File: Camps - Auschwitz Bombing to Camps - Auschwitz WRB Report.

³⁷ Message to WRB from McClelland, Number 4295, 6 July 1944. Copy contained in USHRI Subject File: Camps - Auschwitz Bombing to Camps - Auschwitz WRB Report.

The complete reports, and their associated maps, did not arrive in Allied hands outside of Switzerland until November (confirmed by date on WRB report).³⁸

It remains unclear how much and what kind of information the military commanders in Europe knew about the camp complexes around Oswiecim. As mentioned above, the target information file on Oswiecim contained none of the WRB reports' information. Even two months after the WRB reports were in Washington, the target folder still mentioned only a POW camp.

Further down the command line, at the bomber squadrons themselves, crews of 8th and 15th Air Forces do not recall ever being briefed about Nazi concentration camps, their location, or functions. In personal interviews with four crew members from 15th AF (727th and 838th Bombardment Squadrons) and one from 8th AF (339th Bomb Squadron), none remembered knowing about the camps during the war from official sources. They all had heard of possible atrocities from open press sources, but were never officially briefed, or otherwise informed.³⁹ Milton Groban, a B-17 radar navigator-bombardier, flew with 15th AF both in North Africa and Italy, and also served as a staff officer at 15th AF Headquarters in Bari, Italy. He concurred with the other crew members' recollections and added that information regarding treatment of Jews came only via the press. He added that personnel at the lower levels (Group and Squadron) took more interest in these press reports than 15th AF staff officers. Of major interest was the treatment of downed Jewish

³⁸ U.S., Executive Office of the President, War Refugee Board, German Extermination Camps – Auschwitz and Birkenau, November 1944. Copy contained in USHRI Subject File: Camps - Auschwitz Bombing to Camps - Auschwitz WRB Report. Also, arrival date confirmed by Gilbert, Auschwitz and the Allies, p. 327.

³⁹ Interviews with Sedge Hill, Dick Anderson, Gale Christianson, and John Parks, 451st Bombardment Group Reunion, Fairmont Army Airfield, Fairmont, Nebraska, 15 June 1996.

flyers (himself being a Jewish-American airman).⁴⁰ This concern probably explains why those who flew missions tried to keep-up with Nazi treatment of Jews. The concern became a reality when Jewish flyers were ordered to alter the letter "H" on their dogtags (indicating member's Jewish religious affiliation).⁴¹ The easiest and least noticeable alteration was to imprint a "B" (Baptist) over the "H."⁴²

Despite the claims of Kitchens and Foregger, if Washington had ordered the USAAF to bomb the camp, the available information, when compiled, provided sufficient intelligence to begin planning. By pooling the WRB's information, and the available target intelligence photos from 4 April and 26 June (and depending when the mission planning occurred, the 25 August photos), air force planners would have had a significant amount of information immediately at their disposal.

Both Foregger and Kitchens alluded to the inconsistencies between the escapee reports and the reconnaissance photos. Both argued that the reports (and later the sketch maps) did not provide adequate information for accurate bombing.⁴³ Furthermore, Kitchens asserted that only a personal debriefing of the escapees by Allied personnel could have resolved the inconsistencies between the report and the photos.⁴⁴ This statement is far-fetched and inaccurate. Intelligence personnel would not have ignored information simply due to small inconsistencies. Trained to know that human intelligence reports can be fallible, they could easily have compared the reports to the photos and identified the

⁴⁰ Milton Groban, personal letter to author, 12 May 1996.

⁴¹ Ibid.

⁴² Interview with Milton Groban, Glencoe, Illinois, 22 June 1996.

⁴³ Kitchens, pp. 248-249 and Foregger, "Two Sketch Maps of the Auschwitz-Birkenau Extermination Camps," p. 696.

⁴⁴ Kitchens, p 249.

correct location of the crematorium. Had clarification become necessary, additional reconnaissance missions could have been flown.

The question now returns to the “diversion of assets” so commonly given as the rationale of the War Department’s refusal to bomb. While usually referring to only diversion of aircraft from military targets, the full impact of the effort that would have been required to plan the attack must also be considered. Kitchens correctly stated that without the proper information at hand, military personnel in-theater (and even military and civilian workers in Washington and London) would have been diverted from their normal war tasks to obtain the required intelligence. Such an effort would have required at least staff personnel, intelligence analysts, photo interpreters, and probably additional reconnaissance sorties. Intelligence resources, especially photo analysts, remained a constant priority throughout the war. Spaatz wrote to Arnold in March 1944 confirming that, in both England and the Mediterranean theaters, unless more intelligence, planning, and communications officers arrived, “our air forces will suffer.”⁴⁵

Kitchens also wrote that the necessary intelligence gathering, planning, and bombing could not have been done in time to save the deported Hungarian Jews. Although he did not consider that with the proper authorities directing such events, this mission would have taken a higher priority than other tasks, the mass of Hungarian Jewry could probably have not been saved. The final mass deportation of Hungarian Jews took place on 9 July,⁴⁶ the crematorium continued to operate against the remainder of Auschwitz’s large population. The German Central Construction Office at Auschwitz

⁴⁵ Message to Arnold, from Spaatz, 19 March 1944. Carl Spaatz Collection, Box 14, Personal Diaries, LOC Manuscript Division.

⁴⁶ Yehuda Bauer, *A History of the Holocaust* (New York: Franklin Watts, 1982), p. 314.

estimated that crematoria II-V could incinerate 4,415 bodies each day, with two bodies burned in each oven for 30 minutes. Desiring to increase their capacity, camp authorities ordered the time be reduced to 20 minutes, and up to three bodies burned in each, thus almost doubling their capability to 8,000 bodies per 24 hours.⁴⁷ While perhaps unable to save the mass of Hungarian Jewry (Yehuda Bauer stated that the Nazis gassed approximately 75 per cent of them upon arrival⁴⁸), bombing anytime before November, when gassing operations ceased, carried the possibility of saving many lives. (Bombing accuracy and probability of damage will be discussed later). The population of the Auschwitz camps fluctuated more than usual between the summer and autumn of 1944, due to killings, inflows from other areas and camps, and the beginning of the westward evacuation. Yahil's sources put the 21 August population at 105,168 in all of Auschwitz's areas. By mid-October, the number dropped to around 95,000. At the final role call on January 17, 1945, the number stood at 66,020 inmates.⁴⁹

Pressure from either Roosevelt or Churchill could have ensured that the effort would have received the proper priority and would have been conducted in a timely manner. Without a doubt, to compile the necessary intelligence and plan the mission would have diverted work and assets being used to prosecute the air war against Germany. The full extent of such a diversion cannot be accurately measured, but would probably have been minimal to the overall outcome of the war effort.

⁴⁷ Franciszek Piper, "Gas Chambers and Crematoria," in Anatomy of the Auschwitz Death Camp, eds. Yisrael Gutman and Michael Berenbaum (Bloomington: Indiana University Press, 1994), pp. 165-166.

⁴⁸ Bauer, p. 314.

⁴⁹ Yahil, p. 529.

* * * * *

So far, examination of available evidence suggests that the information existed, or could have been obtained, necessary to plan an attack on the Auschwitz killing facilities. Had such an attack been ordered, the effort would most likely have fallen to 15th AF. By operating from airbases in Italy, it was within range to bomb Auschwitz, and (as will be seen) conducted attacks against strategic targets in and around Upper Silesia. Eighth AF, operating from England, did not have the range to reach Auschwitz. For this reason, historians have focused on the possibility of using 15th AF (Chapter 3 examines the possibility of using Twelfth Air Force or the Mosquito aircraft). Before exploring the possible impact of bombing with 15th AF bombers, it is essential to briefly examine the unit's history and command structure.

THE BIRTH OF FIFTEENTH AIR FORCE

During August 1943, the QUADRANT conference took place in Quebec, Canada. Participants included Roosevelt, Churchill, and the Allied Combined Chiefs of Staff (CCS). Heated discussions took place over possible invasion areas of Nazi-occupied Europe. The U.S. Chiefs of Staff argued for an invasion of Fortress Europe across the English Channel (Operation OVERLORD), while the British pushed to attack the "soft underbelly," the Mediterranean coast of France (Operations ANVIL and later DRAGOON). Eventually, the parties agreed to give top priority to OVERLORD. Also, due to the preponderance of American forces, Churchill suggested changing an earlier

agreement with Roosevelt and giving the invasion command to an American.⁵⁰ Along with OVERLORD, priority was also given to the Combined Bomber Offensive (CBO).

At the QUADRANT meetings, Arnold questioned the ability of using bombers to their maximum capacity from English bases during the winter and suggested supplementing the offensive by using Italian air bases. British Air Chief Marshall Charles Portal, Britain's Chief of Air Staff, agreed with Arnold. He noted that by basing aircraft in Italy, the Allies would be within easy bombing range of factories in southern Germany--two of them accounting for almost 60 per cent of total fighter production. In addition, the oil fields of Ploesti, Romania, would become easier to attack, and attacking the Third Reich from two areas would cause additional problems for German defensive forces. In September 1943, both Eisenhower and Spaatz endorsed Arnold's proposals.⁵¹

Arnold submitted his plans for air operations from Italy to the American Joint Chiefs of Staff (JCS) and the CCS on 9 October. The plan called for splitting Twelfth Air Force, currently operating in North Africa, into two air forces based on roles. Twelfth Air Force (12th AF) would control tactical air forces, and the new Fifteenth Air Force (15th AF) would be responsible for strategic bombing. The nucleus of the Fifteenth came from the six groups of heavy bombers (B-17s and B-24s) in the Twelfth, with other forces later arriving from 8th AF. Eaker, then commanding the 8th AF, objected to losing the bombers and protested the plan as a violation of the principle of concentration of force that would endanger both POINTBLANK (code name for the CBO) and OVERLORD. Doolittle,

⁵⁰ Winston S. Churchill, *Memoirs of the Second World War*. (Boston: Houghton Mifflin Company, 1987), pp. 721-722.

⁵¹ Wesley F. Craven and James L. Cate, eds., *The Army Air Forces in World War II*, 7 vols. (Chicago: The University of Chicago Press, 1949), vol. 2: *Europe: TORCH to POINTBLANK*, pp. 563-564.

then commander of the Northwest Africa Strategic Air Force (NASAF), agreed with the plan, and offered more evidence consistent with the principles as those stated by Portal.⁵²

The JCS approved Arnold's plan, and on 16 October sent Eisenhower a proposed directive for establishing the new air force. Six days later, another message to Eisenhower stated that 15th AF would be established effective 1 November and contained more specific instructions for its establishment. Plans called for 15th AF initially consisting of six heavy bomber groups and two long-range fighter groups, which would be built-up by 31 March 1944 to 21 bomber groups, seven fighter groups, and one reconnaissance group. Afraid of the plan lessening the effect of POINTBLANK, Portal changed sides and opposed the plan along with Eaker and Air Chief Marshal Arthur T. Harris, RAF Commander-in-Chief of Bomber Command.⁵³ The objections, however, proved futile, and on 1 November, 15th AF became operational.

Tunis, Tunisia became the initial 15th AF headquarters, and Doolittle was named the first commander.⁵⁴ However, personnel had already arrived in Bari, Italy and prepared to relocate the command. Exactly one month after its activation, the headquarters in Italy became officially operational. The new organization's chain-of-command went through multiple changes in the first month as the Mediterranean and North African air organizations changed names and streamlined the new command structure. Finally, on 6 January 1944 the U.S. Strategic Air Forces in Europe (USSTAF) became operational.⁵⁵ The operational command over POINTBLANK targets then flowed from the USSTAF to

⁵² *Ibid.*, pp. 564-565.

⁵³ *Ibid.*, pp. 565-567.

⁵⁴ Marvin Downey, ed., *Fifteenth Air Force. History* (Wright Field, Dayton, Ohio: Headquarters Air Material Command, 1946), p. 17. USAFHRA File Number 670.01-1 Vol. 1, c.1.

⁵⁵ Craven and Cate, vol. 2: *Europe: TORCH to POINTBLANK* p. 567.

the Mediterranean Allied Air Forces (MAAF) to the Mediterranean Allied Strategic Air Forces (MASAF) to 15th AF.⁵⁶ The creation of the USSTAF also caused a shuffling of command positions. Doolittle left 15th AF to become commander of 8th AF, and on 3 January 1944 15th AF received the commander who would lead it for the duration of the war, Major General Twining.

FIFTEENTH AIR FORCE: CAPABILITIES AND MISSIONS

When looking at operational directives and capabilities, the timing of planning an attack on Auschwitz must be kept in mind. As shown above, the required intelligence was not available before late June 1944. However, by July and August, enough information was available (or could have been so) to plan and carry out an attack. These two months were the optimum time to attack, and offered the best chance to save the Hungarian Jews. While attacks could have taken place from September to December, weather factors decreased the possibility of success. Therefore, this study pays maximum attention to the late summer months of 1944.

The original plans called for 15th AF to fill-out its combat complement of units by March 1944. The air force's organization initially envisioned seven bombardment wings, each controlling three heavy bomb groups and one fighter group. The growing force underwent several organizational changes and unit shuffling throughout the first seven months. By June 1944, 15th AF controlled five bomb wings (BW) and one fighter wing. The 5th BW included six groups of B-17 Flying Fortresses. The remaining wings (47th,

⁵⁶ Downey, pp. 20-22 (and charts between these pages).

304th, 55th, and 49th) operated B-24 Liberators. All B-24 wings contained four groups except the 49th, which included only three.⁵⁷

**Table 1: 15th Air Force's Tactical Units
(as of 15 June 1944)⁵⁸**

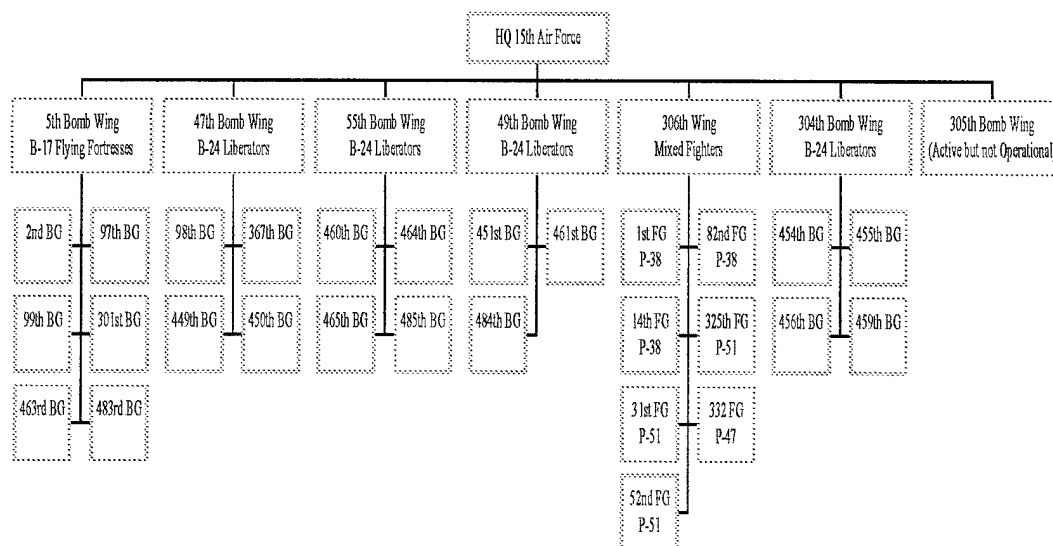

Contrary to the initial plan, the fighter force organized a separate wing, the 306th Fighter Wing. The wing included three groups each of P-38s and P-51s, and one P-47 group. In September, the fighter force reorganized. The 305th Fighter Wing (Provisional) became operational and administered the three P-38 groups.⁵⁹ All P-51 operations came under the 306th FW, because in June the 332nd FG converted from the P-47 to the P-51.⁶⁰

⁵⁷ Ibid, pp. 23-31.

⁵⁸ Ibid.

⁵⁹ Ibid, pp. 31-33.

⁶⁰ Maurer Maurer, ed., *Air Force Combat Units of World War II* (Washington, D.C.: Office of Air Force History, 1983), p. 212.

Figure 5: 15th Air Force Bases 1 of 2⁶¹

MANDURIA (47TH WING) AND FOGGIA (5TH WING) AREAS

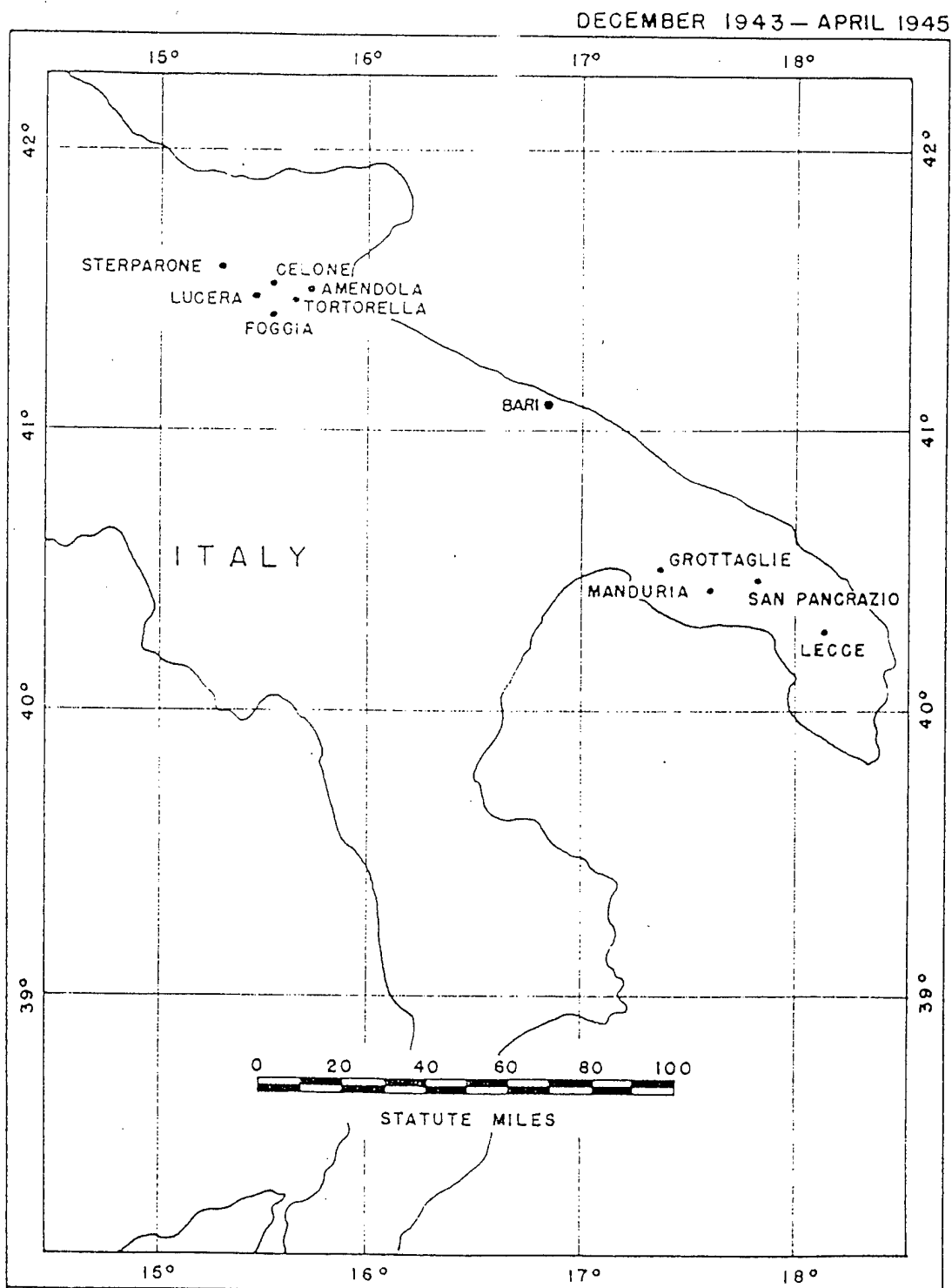

⁶¹ Reprinted From: Downey, pp. 20-22 (and charts between these pages).

Figure 6: 15th Air Force Bases 2 of 2⁶²

CERIGNOLA (304th WING), SPINAZZOLA (55th WING)
AND
DELLA MADONNA, INCORONATA (49th WING)
AREAS JANUARY 1944-APRIL 1945

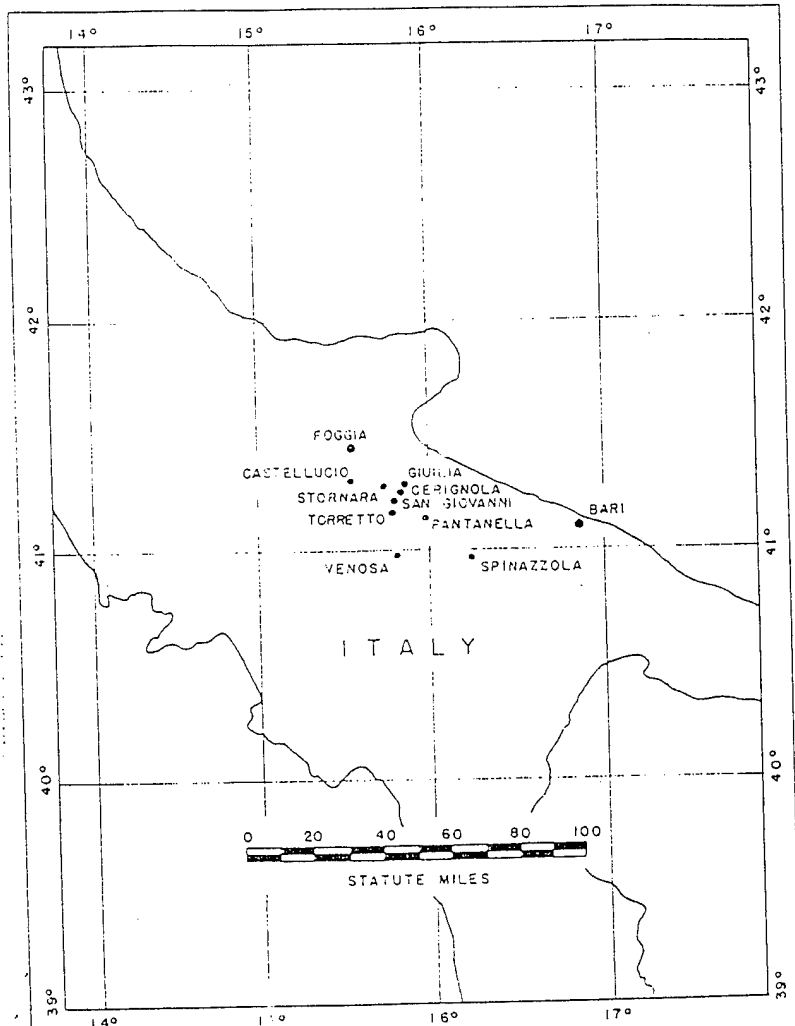

Although smaller than 8th AF, the 15th AF represented a sizable force. On 7 June, 15th AF reported 1146 heavy bombers on hand, compared to 8th AF's 2786. Of 15th's total force, 63% (720 bombers) were operational.⁶³ From 7 June until 30 September, 15th AF averaged 1204 bombers on hand each day. Of these, an average of 914, 76%, were

⁶² Ibid.

⁶³ Statistical Control Office, USSTAF, Daily Operations Report, Eighth and Fifteenth Air Forces, 7 June 1944, USAFHRA File Number 519.308-2.

reported as ready for duty.⁶⁴ Compared to 8th AF during the same period, 15th AF averaged fewer than half as many bombers on-hand, but their operational rate was twelve percent higher. These numbers also reflect an acute shortage of replacement B-17s during the summer of 1944 due to increased B-29 production at the expense of the Fortress.⁶⁵

With such a significant force available, the next question follows; what were they doing? Specifically, the tasking and bombing directives require examination. At the Combined Bomber Offensive's inception, submarine bases topped the list of priority targets due to the Allied concerns over German interdiction efforts in the Battle of the Atlantic. However, early in 1944, the attention turned to preparations for OVERLORD and concern towards the strength of the German Air Force (GAF). The 13 February 1944 directive from the Combined Chiefs of Staff (CCS) formally placed the Luftwaffe at the top of the bombing list. The first priority became fighter airframe and component production, and installations supporting the German fighter force followed.⁶⁶

As the German fighter threat diminished in the spring and early summer of 1944, Spaatz viewed oil as the most promising strategic objective. On 8 June 1944, only two days after the Normandy landings, he ordered that the USSTAF's strategic aim be shifted to denying oil to the enemy. The order remained in force for the war's duration.⁶⁷ As a result of Spaatz's order, the MAAF sent a revised bombing directive to its units on 15 June 1944. The directive gave special missions, as required and directed by the

⁶⁴ Numbers derived by taking the last Daily Operations Report from each week from 7 June to 30 October and averaging the numbers. Reports used were: 7, 14, 21, and 28 June; 7, 14, 21, and 28 July; 7, 14, and 28 August; 7, 14, 21, and 30 September.

⁶⁵ Downey, pp. 75-76.

⁶⁶ Craven and Cate, vol. 3: Europe: Argument to V-E Day, pp. 27-28.

⁶⁷ *Ibid*, pp. 280-281.

commander, to support the land campaign in Italy and air support for OVERLORD as the first two target priorities. The third priority, POINTBLANK targets, had oil as the primary objective, followed by counter-air and communications targets.⁶⁸

Eighteen days after it became effective, MAAF rescinded the 15 July bombing directive and ordered new priorities. The 3 August directive kept oil as the top priority (Oswiecim facilities became target number nine), but remaining sources of ball and roller bearings moved to second, and counter-air came third. Although the wording regarding special targets as the top two priorities no longer appeared, the directive allowed for variations from the target list. If necessary, tactical uses of strategic bombers to aid the ground forces could replace the strategic priorities. Also, the directive stated, "specific attacks against targets in the above categories or any others may be ordered by this Headquarters from time to time."⁶⁹ Throughout the remainder of August and September, only minor changes occurred in this list. Spaatz issued a clarification of target priorities on 1 September. He urged using the remaining good weather to intensify attacks against oil targets, and he changed the second priority from bearings to rocket and jet propelled fighters and aircraft engine factories.⁷⁰ A new bombing directive on 13 September duplicated the 3 August directive but added communications targets as the fourth priority.⁷¹

⁶⁸ Office of the Director of Operations, Headquarters Mediterranean Allied Air Forces, Bombing Directive, 15 June 1944, USAFHRA File Number 670.01-3C, Annex 19.

⁶⁹ Office of the Director of Operations, Headquarters Mediterranean Allied Air Forces, Bombing Directive, 3 August 1944, USAFHRA File Number 670.01-3C, Annex 19.

⁷⁰ Message to Commanders of Eighth, Fifteenth, and Mediterranean Allied Air Forces, from Spaatz, Target Priorities, 1 September 1944, USAFHRA File Number 670.01-3C, Annex 19.

⁷¹ Office of the Director of Operations, Headquarters Mediterranean Allied Air Forces, Bombing Directive, 13 September 1944, USAFHRA File Number 670.01-3C, Annex 19.

The evidence presented clearly shows the ability of 15th AF to bomb Auschwitz. By the summer of 1944, the command controlled ample aircraft, and those aircraft had the sufficient range and payloads necessary for such a mission. Also, the bombing directives allowed the flexibility for commanders to direct attacks against special targets.

ANALYSIS OF GERMAN DEFENSES

Critics of the failure to bomb the crematoria tend to underestimate the German air defenses in 1944, while those who support the non-bombing use an overly-simplistic analysis. The Germans, like all World War II combatants, used two main systems for air defense: fighter aircraft and anti-aircraft guns. On the Nazi side, the former was in decline by the summer and fall of 1944, while the latter became the most effective. Each will be examined, in-turn, by looking at the threat perceived by planners, as well as their actual effect on bombing missions on and around Oswiecim.

Writers supporting a bombing effort correctly point out that the USAAF controlled the skies of Europe by mid-1944. However, they mischaracterize the notion of "air superiority." While Allied aircraft could fly over the continent with a higher degree of safety than in 1943, this did not translate into being able to fly with impunity. German fighters still represented a threat and continued to attack Allied aircraft. However, due to dwindling resources, especially fuel, they marshaled their forces and attacked only when they saw a possible advantage or when targets they viewed as essential for defense became threatened.

Spaatz, in his weekly summaries to Arnold, mentioned the GAF tactics on two separate occasions in early and mid-1944. On 4 March he wrote, "The enemy has been

unable or unwilling to send his fighters in strength against [operations of the past week]. [I] believe he will withhold them except when weather conditions over Germany indicate good visual bombings over vital areas.”⁷² Spaatz summarized the enemy fighter tactics in his 8 May message. “German fighter forces,” he wrote, “can no longer oppose our attacks indiscriminately but must, for purposes of conservation, select occasions when they have a tactical advantage.”⁷³ Therefore, the time-frame and area of attack must be analyzed to make possible an accurate analysis of German fighter opposition.

Among other duties, estimating and reporting on enemy air activity within 15th AF fell to the Assistant Chief of Staff for Intelligence (designated A-2). During 15th's first year of operation, Colonel Charles A. Young held this position. By 1 November 1944, Colonel Percy M. Barr succeeded Young, and remained the A-2 for the war's duration. Their staffs produced several reports on enemy fighter defenses for the period in question. A 10 July report analyzed enemy fighter opposition to the Allies' 7 July attack on Blechhammer (another important oil target located just over 40 miles northwest of Oswiecim, and contained a sub-camp of Auschwitz providing slave labor). The Blechhammer attack represented a concerted effort of 8th and 15th AF to attack oil targets in the region. The total effort sent more than 1,000 B-17s and B-24s, with German fighters downing only 25 bombers.⁷⁴ Due to the importance of the targets, the Germans sent at least 400 sorties against the formations (approximately 300 aircraft, but some landing and attacking again). The intelligence report indicated 225 fighters assembled

⁷² Message to Arnold, from Spaatz, Message numbered k 4035, 4 March 1944, USAFHRA File Number 519.308-1.

⁷³ Message to Arnold, from Spaatz, Message numbered U61850, 8 May 1944, USAFHRA File Number 519.308-1.

⁷⁴ Craven and Cate, vol. 3: Europe: Argument to V-E Day, p. 291.

along the Vienna-Gyor line (Gyor is approximately 70 miles east of Vienna, or half-way between Vienna and Budapest). From Vienna to the target area, between 100 and 125 more aircraft attacked the formations. Finally, 40 to 50 fighters (flying for the second time against the mission) intercepted the bombers near Gyor.⁷⁵ Although a significant effort by the Luftwaffe, it did not react the same when bombers attacked similar targets in the same area only six weeks later.

The first attack on the Oswiecim oil refinery occurred on 20 August 1944 as part of a larger attack on Polish and Czechoslovakian oil facilities. The attack plan called for five of the six B-17 groups of the 5th BW to attack Oswiecim with 28 bombers each, for a total of 140.⁷⁶ In addition, ten of the twelve groups of B-24s in the 47th, 304th, and 55th bomb wings would target the refineries at Szolnok (Hungary), Dubova (Czech.), and Czechowice (Poland). The three B-24 groups of the 49th BW would attack Szolnok-Rakoczifalva airfield. The plan included using five groups of fighters from the 306th wing for escort.⁷⁷ The intelligence annex estimated that the enemy could oppose the attack with up to 110 sorties in the Budapest-Vienna area, and could reinforce the effort with 30-35 fighters from the Munich area. In addition, target area opposition could include 50-60 fighters, at most.⁷⁸ Milton Groban, one of the mission's radar-bombardiers, wrote in his diary, "we were expecting plenty of Luftwaffe because we were going into their

⁷⁵ Headquarters Fifteenth Air Force, Office of the Assistant Chief of Staff A-2, Special Intelligence Report No. 63, 10 July 1944, USAFHRA File Number 670.6012-63.

⁷⁶ Headquarters Fifth Wing, Operations Order no. 671, 19 August 1944 and A-2 Section, ⁷⁶ Headquarters Fifth Wing, Annex to Operations Order no. 671 for 20 August 1944, 19 August 1944, USAFHRA File Number 670.332.

⁷⁷ Headquarters Fifty-Fifth Bomb Wing, Operations Order Number 156, 19 August 1944, USAFHRA File Number 670.332.

⁷⁸ Headquarters Fifty-Fifth Bombardment Wing (Hv), Intelligence Annex No. 156 to Operations Order no. 156, 19 August 1944, USAFHRA File Number 670.332.

stronghold.”⁷⁹ However, on 20 August, the Luftwaffe disproved his and 15th AF’s expectations.

The 15th AF A-2 report on the attacks called enemy opposition to the 20 August attacks “meager.” After analyzing the separate reports from all fighter and bomber groups, the A-2 concluded that the formations saw only 35 to 45 enemy aircraft. Of these, 15 to 25 made a single-pass attack at the bombers as they passed east of Budapest, and the escorting fighters drove them away. Only two Me-109s attacked near the target areas. They targeted a “straggler” (a damaged bomber lagging behind the formation), but did not succeed in bringing the aircraft down.⁸⁰ All bombers from the 5th BW returned to their base, and the remainder of the bombers reported no losses to enemy fighters. In fact, the 97th BG claimed its bomber crews shot down one Me-109, a second Me-109 kill was reported as probable, and a third one was damaged.⁸¹

The decline in enemy activity from the 7 July Blechhammer attack to the 20 August attacks around Oswiecim should not be interpreted as a trend. Only two days after the Oswiecim attacks, 15th AF again attacked targets in Vienna and Blechhammer drawing a reaction from 150 enemy aircraft.⁸² Also, Oswiecim was attacked again on 13 September when the 55th BW tasked a “normal effort” for all four of its B-24 groups against the oil refinery.⁸³ Of the 115 bombers tasked, 101 arrived over the target area.

⁷⁹ Milton Groban, Personal Combat Diary, Mission 25/26, 20 August 1944.

⁸⁰ Headquarters Fifteenth Air Force, Office of the Assistant Chief of Staff A-2, Special Intelligence Report No. 67, 24 August 1944, USAFHRA File Number 670.6012-67.

⁸¹ Headquarters 97th Bombardment Group (H), Group Intelligence Office, Special Narrative Report: Mission: 20 August 1944 - Oswiecim Synthetic O/R, Poland, 20 August 1944, USAFHRA File Number 670.332.

⁸² Headquarters Fifteenth Air Force, Office of the Assistant Chief of Staff A-2, Special Intelligence Report No. 68, 26 August 1944, USAFHRA File Number 670.6012-68.

⁸³ Headquarters Fifty-Fifth Bomb Wing (H), Operations Memorandum Number 175, 12 September 1944, USAFHRA File Number 670.332.

Two of the groups reported seeing no enemy fighters, one reported seeing nine (six over the target area), and the other reported seeing three. None of the fighters engaged the bombers.⁸⁴ The mission and intelligence reports correspond with aircrew recollections. All six crew-members interviewed said that although the Luftwaffe was not as aggressive and feared as they were prior to 1944, they remained a threat to be respected. In addition, all agreed that flak was the primary danger to the bombers. While the Luftwaffe threat declined as the 1944 wore on, the flak became more numerous and “damned accurate.”⁸⁵

The revised A-2 Intelligence Plan assumed that, due to the declining capacity of the Luftwaffe, the Nazis would utilize anti-aircraft (AA) guns to their maximum capacity. A-2 also believed that the concentration of guns could increase due to a fairly steady availability of AA guns concentrated within the Nazis’ constantly shrinking territory. The document also noted that with the Third Reich trying to defend its precious oil supplies and production capabilities, these areas contained some of the heaviest AA defenses. At the time of the report, Blechhammer was the eighth most heavily defended target in Europe.⁸⁶

Flak defenses around the Oswiecim I.G. Farben facility totaled 316 heavy guns in late August. The 20 August tasking order’s intelligence annex includes those guns around Vitkovice (35 miles southwest), Crakow (20 miles east), and Katowice-Gleiwitz (15 miles

⁸⁴ See separate reports by Headquarters’ 460th, 464th, 465th, and 485th Bombardment Groups (H), Narrative Mission Report, 12 and 13 September, USAFHRA File Number 670.332.

⁸⁵ Interviews with Sedge Hill, Dick Anderson, Gale Christianson, and John Parks, 451st Bombardment Group Reunion, Fairmont Army Airfield, Fairmont, Nebraska, 15 June 1996. Also, Groban interview.

⁸⁶ Headquarters, Fifteenth Air Force, Intelligence Plan, 24 August 1944, USAFHRA File Number 670.01-3C. Annex 19.

west) as being target area defenses.⁸⁷ These guns could target aircraft during their bombing run, during their time in the target area, or during their post-strike recovery prior to exiting the target area.

The mission reports, however, revealed that the flak defenses did not take a toll on the attackers. Two of the groups (99th and 2nd) reported the defensive fire as accurate, but only moderate in intensity. The remaining three groups of B-17s called the flak inaccurate and moderate.⁸⁸ The difference in reporting does not represent inaccuracies by one or the other group. As in all large-scale bombing missions, the formations of aircraft could extend out miles on either side, and appeared over the target area at different times. The groups arrived over the target separately, but all dropped their ordnance between 1030 and 1100 hours. The flak downed no aircraft, but 45 B-17s received minor damage, and one was severely damaged. In addition, flak wounded one man in the leg.

Less than one month later, 15th AF's visit would meet with different fate from the German's guns. Although not providing a specific count, the 13 September's pre-strike intelligence annex specified that "heavy guns have been added since [the 20 August attack]."⁸⁹ All four B-24 groups reported the target area flak as accurate and intense. Of the 101 aircraft flying over the target area, nine did not return to Italy. Four aircraft went down in the target area, four more made forced landings in Yugoslavia, two headed towards Russian territory, and one ditched in the Adriatic. In addition, eight B-24s

⁸⁷ Headquarters Fifth Wing, Annex to Operations Order no. 671 for 20 August 1944, 19 August 1944, USAFHRA File Number 670.332.

⁸⁸ See separate reports by Headquarters 99th, 301st, 97th, 2nd, and 483rd Bombardment Groups, Special Narrative Mission Report: Mission: 20 August 1944 - Oswiecim Synthetic Oil Works, Poland, 20 August 1944, USAFHRA File Number 670.332.

⁸⁹ Headquarters Fifty-Fifth Bomb Wing (H), Intelligence Annex No. 175 to Operations Order No. 175, 12 September 1944, USAFHRA File Number 670.332.

recovered with severe flak damage, while 44 more reported minor damage, and two crewmen were injured. Only 37 of the 101 aircraft returned unscathed.⁹⁰

The crematoria at Birkenau were slightly more than four miles from the oil facility. Although camp commandant Rudolf Höss and the escapees from Auschwitz all mentioned AA guns being in the camp⁹¹, the distance between Birkenau and the refinery would still allow the guns protecting the oil facility to engage bombers over Auschwitz. German flak guns ranged from the 88 to 128 mm. The most numerous was the 88mm Flak-36. Its maximum ranges extended 14, 860 meters (9.2 miles) horizontal, and 10,600 meters (6.6 miles) vertical.⁹² Still, one must consider whether German gunners would have targeted the bombers when they were not attacking the oil refinery. It would be reasonable to assume that if they did, because of the increased range from their positions, the damage would not have compared to the casualties suffered on 13 September.

Clearly, neither the fighter nor flak threat represented such a danger to a proposed attack against the Birkenau crematorium that air leaders would have argued against it. Bombing accuracy, however, presented a larger threat—not to the bombing forces, but to those the bombing would have attempted to save.

⁹⁰ See separate reports by Headquarters 460th, 464th, 465th, and 485th Bombardment Groups, Narrative Mission Report, 13 September 1944, USAFHRA File Number 670.332.

⁹¹ Rudolf Höss, Commandant of Auschwitz: The Autobiography of Rudolf Hoess, trans. Constantine Fitz-Gibbon (London: Weldenfeld and Nicolson, 1959), p. 191 and Rudolf Vrba and Alan Bestic, I Cannot Forgive (New York: Grove Press, 1964), p. 233.

⁹² Rudolf Luser, Die deutschen Waffen und Geheimwaffen des 2. Weltkrieges und ihre Weiterentwicklung (München: J.F. Lehmanns Verlag, 1971), p. 232.

WEAPONEEING THE TARGET

Before analyzing accuracy, the weight of effort required to destroy the gas chambers and crematoria requires examination. Weaponeering, a term used in today's target analysis, defines a target's characteristics and the number of bombs and aircraft needed to achieve probable destruction. Weaponeering will also provide insight into how much of a diversion of resources the attack would have demanded. Selecting and defining the target is the first step in weaponeering, followed by examination of target construction. From the type and construction, the targeting officer selects the type and number of weapons to best destroy the target. The number of bombs needed determines the number of aircraft required to carry them. The expected damage is expressed in a "probability of damage."

By 1944, Birkenau contained all of the operational gas chambers and crematoria. Crematorium I at the main camp (Auschwitz I), and its attached gas chamber, ceased operation in December 1942. In 1942, two small cottages near Birkenau, Called Bunkers One and Two by the SS, took over the majority of the gassing operations. These small, brick buildings could not have been targeted. Surrounded by woods, Bunker One measured only 49 X 21 feet and Bunker Two, 56 X 27 feet.⁹³ In addition, intelligence sources did not know of these buildings' existence. Being converted houses separate from the main area, they would have received little attention from photographic analysts unless other sources revealed their purpose. Neither Vrba or Wetzler knew of their operation,

⁹³ Piper, pp. 158-162.

and their report identifies only the four large crematoria at Birkenau as being in operation.⁹⁴

Birkenau's four main killing facilities were located on the camp's west side. Numbers II and III, built to almost identical specifications, contained three parts; two of them underground. The "dressing room," where victims disrobed, measured 162 X 26 feet and used an outside entrance to get underground. The gas chamber, also underground, measured 99 X 23 feet. Being underground did not necessarily hide their existence. If a photo technician specifically looked at Birkenau for pre-strike reconnaissance, it is possible he would have seen these. Combining the known intelligence from the escapees reports—therefore knowing of their existence—a photo-interpreter could have located them. Examination of aerial photographs (using the modern techniques of Brugioni and Poirier discussed in Chapter One) shows the outline of both, and the gas vents of the killing chamber. The above-ground crematorium buildings, 99 X 37 feet, would serve as the aiming point.⁹⁵ These calculations, taken from the original plans, differ slightly from those in Foregger's article. Foregger used Poirier's figures, measurements taken from analysis of the aerial photographs. Obviously, personnel of the day could not access the original plans.⁹⁶ Therefore, for weaponeering purposes this study will also utilize Foregger's figures for facilities II and III. He used 352 X 41 feet as the overall size of each building complex.⁹⁷ Like the first two, Crematoria IV and V, located

⁹⁴ The Extermination Camps of Auschwitz (Oswiecim) and Birkenau in Upper Silesia, p. 14.

⁹⁵ Piper, p. 166.

⁹⁶ Plates of the original plans, as well as the development and plans for Auschwitz, are in Debórah Dwork and Robert-Jan van Pelt, Auschwitz: 1270 to the Present (New York: W.W. Norton & Company, 1996).

⁹⁷ Foregger, Technical Analysis, p. 404 and footnote number 6, p. 417.

1746 feet from III, represented a "matched set." Their complex's measured 220 X 42 feet (of interest, here Foregger's figures match the plans).

Figure 7: Birkenau⁹⁸

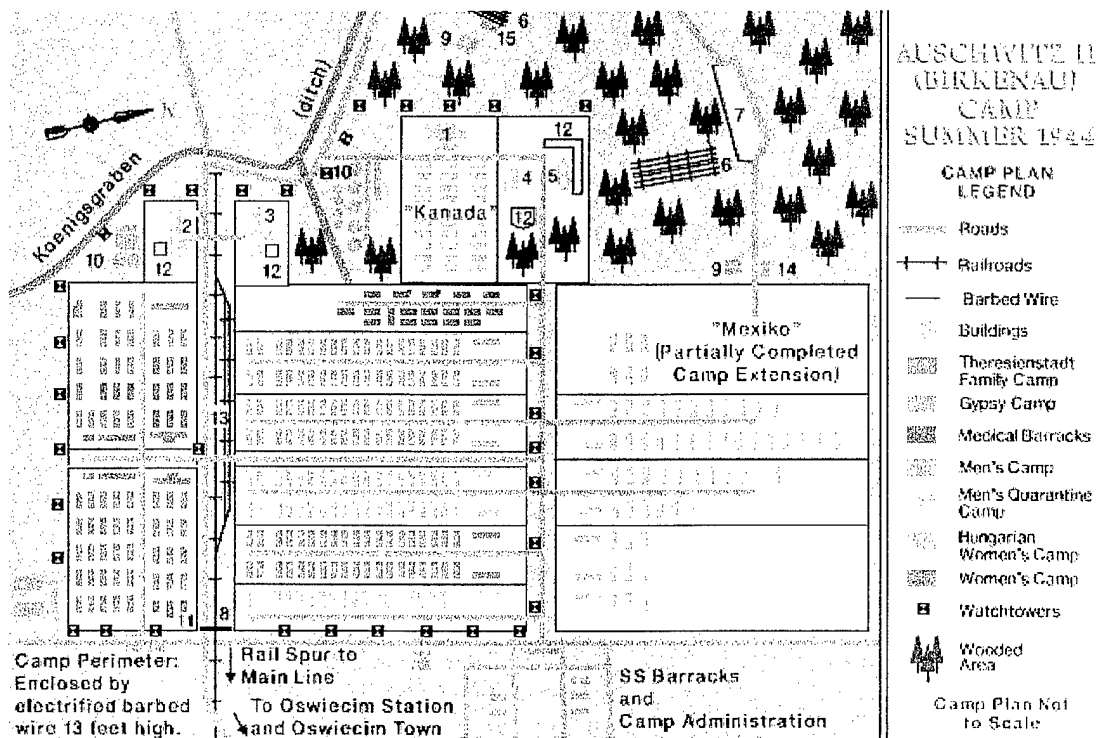

Crematoria II-V labeled as 2-5, located at top of map.

Figure 8: Foregger Sketch⁹⁹

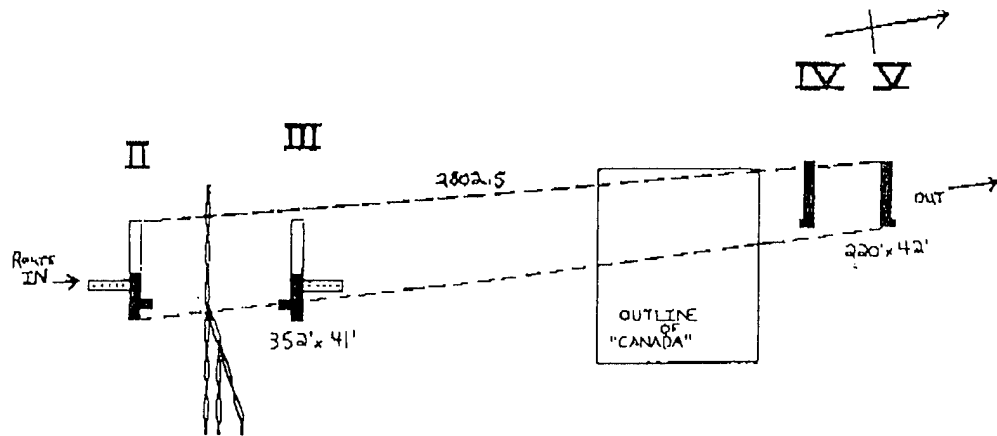

⁹⁸ Gilbert. *Atlas of the Holocaust*. p. 96.

⁹⁹ Foregger, "Technical Analysis," p. 406, imaged edited by author to improve readability in reproduction.

Note: Sketch shows crematoria sizes (darkened areas are above ground), and proposed approach direction.

Railroad spur is located between facilities II and III.

Foregger used wall and roof thickness to determine bombs and fuzing. Assuming any planning effort would have used the Vrba-Wetzler report and reconnaissance photographs, it is doubtful they would have known these precise elements of construction. However, Foregger's analysis finds this construction required 500-pound general purpose bombs with delayed fuzes. The 500-pounder was the standard weapon used by the USAAF, and would probably have been the weapon chosen anyway. The delayed fuzing allowed for penetration before exploding. However, even an impact on the crematorium or the above-ground vent area without delayed fuzing would have caused damage. Also, Groban mentioned that ordnance personnel briefed the pilots on their weapons load during the mass-briefings before each mission. He concluded that for a target partially above, and partially below ground, ordnance crews would set a mixed fuzing. Some bombs would detonate on impact, and others would allow some penetration.¹⁰⁰

~~His~~^{Foregger's} calculations (of which he gives no details), for facilities II and III, figured that these two buildings would require 400 bombs for a 64% chance of damaging each complex. Half as many bombs would provide a 50% chance.¹⁰¹ Facilities IV and V, being smaller, gave only a 60% probability with 400 bombs, and 39% with 200, for each complex. A typical heavy bomber carried ten bombs (as did the raids against the Oswiecim refinery). Therefore, it would require 160 bombers to obtain at least a 60% chance of damaging all four buildings. As a comparison, the September raid on the I.G.

¹⁰⁰ Groban Interview.

¹⁰¹ Foregger, "Technical Analysis," p. 407.

Farben oil refinery tasked 115 B-24s, and only 101 reached the target.¹⁰² The tasking represented a normal effort for all four groups of the 55th BW.

A comparison can be drawn, again using the oil refinery attacks as a reference for bombing effort. If the 55th BW used 28 bombers from each of the four groups, each group could target one of the facilities. Only 280 bombs would be targeted for each facility, giving a less than 50% chance of a hit.

Since Foregger did not provide details on his calculations, an independent study was done using three different methods. The first two methods will use the figures for bombing probabilities from the Handbook for Bombardiers (same book Foregger used). A final method will examine numbers produced by modern computer-based software using ballistics for the standard 500-pound bomb.

To completely weaponeer a target from scratch is very detailed. Figures and formulas for ballistic error, bomb and fuze reliability, stick length (distance of bomb impacts on the ground), intervalometer settings (time between release of bombs), and slant range (angular distance from bomber to target) all effect bombing probabilities. From these numbers, a Range Error Probable and Deflection Error Probable can be calculated and assist in finding the Single-Shot Probability (SSP). The SSP gives the number of individually sighted and released bombs necessary to achieve at least one hit with a prescribed degree of assurance.¹⁰³ Fortunately, the Handbook for Bombardiers provided tables whereby, if certain elements were known, others could be derived from charts.

¹⁰² See separate reports by Headquarters' 460th, 464th, 465th, and 485th Bombardment Groups (H), Narrative Mission Report, 12 and 13 September, USAFHRA File Number 670.332.

¹⁰³ U.S. War Department, Handbook for Bombardiers, TM 1-251, 31 March 1941, p. 48.

The first method begins by selecting the probable range and deflection errors. Using a 20,000-foot bombing altitude, the range and deflection errors probable are 201 and 250. Next, the Vulnerability factor (V_f) for each is determined. Using the dimensions of crematoria I and II as the allowable errors (since any error beyond these would miss the buildings), the range $V_f=0.20$ which translates to a Range Single-Shot Probability (RSSP) of 0.1073. The deflection $V_f=1.408$ gives a 0.6584 Deflection Single-Shot Probability (DSSP).¹⁰⁴ Multiplying these two figures gives a SSP=0.07 for the first two targets.¹⁰⁵ Using the same methodology for crematoria IV and V calculates to an SSP of 0.05 (smaller due to smaller buildings).

Using the smaller SSP, the charts show that if for each ten bombs dropped (one bomber's load), there existed a 40.131% chance of hitting the target one or more times.¹⁰⁶ Furthermore, 105 bombs would give a 99.5% chance of at least one hit on one building. If one group of heavy bombers attacked each building with 25 bombers each (250 bombs), there was a 99.5% chance that five or more bombs would strike each building.¹⁰⁷

These figures probably represent high numbers. The original range and deflection errors probable (from Table I in Handbook), when calculated to a Circular Error Probable (CEP), come to a 392-foot radius—far better than any World War II heavy bomber. Therefore, a second method using the charts must be calculated.

Circular-error probable (CEP) describes the probability of one-half of the bombs falling within a circle of designated radius. During August and September 1944, the CEP of

¹⁰⁴ Using Tables I and II from Handbook for Bombardiers, pp. 57-58.

¹⁰⁵ Formula in Handbook for Bombardiers, p. 47.

¹⁰⁶ Table IV, Handbook for Bombardiers, p. 60.

¹⁰⁷ Chart 9, Handbook for Bombardiers, pp. 80-81.

all aimed bombs in 15th AF was 800 feet.¹⁰⁸ Using the width of the smaller crematoria (220 feet), the target radius would be 110 feet. Again using the Handbook, these figures correspond to a $V_f=0.1375$ and a SSP of less than 0.01. This SSP corresponds to the third method's findings.

Captain Gary Thomas, a target intelligence instructor at Goodfellow Air Force Base, Texas, the Air Force's intelligence training center, used a computer program to check the SSP. The program would be valid for such computations since the 500-pound bomb's ballistics remain virtually unchanged. Using various intervalometer settings and altitudes between 18,000 and 20,000 feet, the SSP computed to 0.01, the lowest output available.¹⁰⁹ Using the 0.01 SSP, the Handbook's charts show that every 10 bombs will give a 9.56% chance of hitting the target at least once. Also, 220 bombs on each crematoria would give a 90% chance one hit or more.

These calculations consider bombing accuracy in terms of the probability of hitting the target. Many other factors must be considered, including bomber methods and tactics. Different tactics and altitudes could increase the probability of success and decrease the number of bombs possibly striking the barracks areas. Therefore, a further analysis of accuracy and probability for collateral damage remains in order.

¹⁰⁸ First Operations Analysis Section, Fifteenth Air Force, Bombing Accuracy – Aiming Errors and Pattern Dimensions, 31 October 1944. USAFHRA File Number 670.310-1, pp. 1.

¹⁰⁹ Captain Gary Thomas, USAF, telephone interview, 3 October 1996. NOTE: Results are unofficial and do not represent the official position of the USAF.

BOMBING METHODS, TACTICS, AND ACCURACY

What military personnel called “precision bombing” during World War II bears no resemblance to the use of the same term today. Instead, it meant that a specific target was being attacked rather than an area target. The precision arose from planning to bomb a specific target, and selecting a desired Mean Point of Impact (MPI). The alternative was area bombing, or “carpet bombing,” in which bombardiers did not select specific targets, but dropped their bombs on geographic areas.

For the most part, RAF Bomber Command conducted the Combined Bomber Offensive’s area night bombing while the U.S. strategic force practiced daylight, precision bombing. The RAF experimented with attacking individual targets in 1940, but believed the effort too costly and ineffective. Believing the bombing technology and intelligence lagged too far behind bomber capabilities to be of use, the RAF opted for attacking German cities and their large industrial areas.¹¹⁰ The USAAF entered the war believing in the ability of a heavily-armed bomber to attack specific installations with “pin-point” and “pickle-barrel” accuracy. To achieve such accuracy, the attacks must take place in daylight. However, during battle conditions, and due to technological limitations, such accuracy did not become commonplace. The USAAF adopted a “target area” to define accuracy. It considered bombs falling within a circle with a radius of 1,000 feet around the aiming point, or MPI, as being within the target area.¹¹¹ As will be seen, the daily and weekly accuracy reports used this circle to establish accuracy.

¹¹⁰ R. J. Overy, *The Air War 1939-1945* (New York: Stein and Day, 1981), pp. 139-142.

¹¹¹ David MacIssac, gen. ed., “Summary Report (European War),” 30 September 1945, *The United States Strategic Bombing Survey*, 10 vols. (New York: Garland Publishing, Inc., 1976), vol. 1, p. 5.

One important factor requires clarification. Bombing accuracy statistics and analysis beg examination only because of the proximity of the prisoner barracks to the gas chambers and crematoria. Had the killing facilities been detached from the camp, large-scale bombing could have been accomplished without considering the deaths of those who the bombing attempted to save. Again, reconnaissance photos and the escapee reports would have shown planners the necessity of minimizing bomb deflection errors. Due to this proximity, not only does the accuracy of the bombers obligate examination, but certain methods of bombing must be excluded because of their gross inaccuracy.

“Blind bombing” meant bombing without visually acquiring the target or any other reference point.¹¹² Usually, this meant bombing from above cloud cover, but the increase in the German’s use of smoke generators created additional target acquisition problems. These generators were used during the August and September attacks on the Oswiecim refinery, and achieved their desired effect. Not only did the smoke partially obscure the target during bombing, but four of the five groups on the first mission could not report accuracy results.¹¹³ Due to the European weather, the military looked for ways to improve upon bombing accuracy when weather (or smoke) obscured the target. As earlier missions against I.G. Farben proved, smoke generators could affect bombing accuracy. Although due to the distance between Birkenau and the oil plant, it is doubtful that any smoke screen could have obscured the camp.

The Massachusetts Institute of Technology’s Radiation Laboratory improved on an RAF radar-bombing system, designated H2S. Eighth AF first used the American

¹¹² First Operations Analysis Section, Fifteenth Air Force, Development of Radar Bombing—Fifteenth Air Force, 18 January 1945. USAFHRA File Number 670.310-6.

version, H2X, in November 1943.¹¹⁴ The system (also known as AN/APS-15, Pathfinder, PFF, or “Mickey”) became a valuable tool, but did not provide pin-point bombing in limited visibility. Both the August and September attacks against the Oswiecim refinery used the Pathfinder as a bombing aid. Groban was closely associated with the Pathfinder induction into 15th AF and training of its crews. He wrote a training manual on the system titled Bombs through the Undercast. The book, and training he directed, proved so valuable that he received the Bronze Star medal for his efforts.¹¹⁵ Although, the H2X system aided navigation and allowed the bombers to bomb with improved confidence, it remained unreliable.¹¹⁶ Using the system effectively required additional training, intelligence support, and operator proficiency.¹¹⁷

One way to train the operators included using “pictures” taken by the scopes of targets, and having the operators identify the target. The following figure demonstrates the Pathfinder’s view of the Oswiecim refinery and surrounding area.

¹¹³ First Operations Analysis Section, Fifteenth Air Force, Bombing Accuracy, 20 August 1944, Daily Bombing Accuracy Reports, USAFHRA File Number 670.56-3.

¹¹⁴ Craven and Cate, vol. 3, pp. 14-16.

¹¹⁵ Groban Interview.

¹¹⁶ Ibid.

¹¹⁷ Headquarters Eighth Air Force, H2X Intelligence Program, 12 April 1944, p. 1-4. USAFHRA File Number 670.317-3 vol 1. Also Assistant Chief of Staff A-3, Fifteenth Air Force, Bombs Through the Undercast. A Pathfinder Manual of Operation and Technique, copy used by author acquired from Milton Groban.

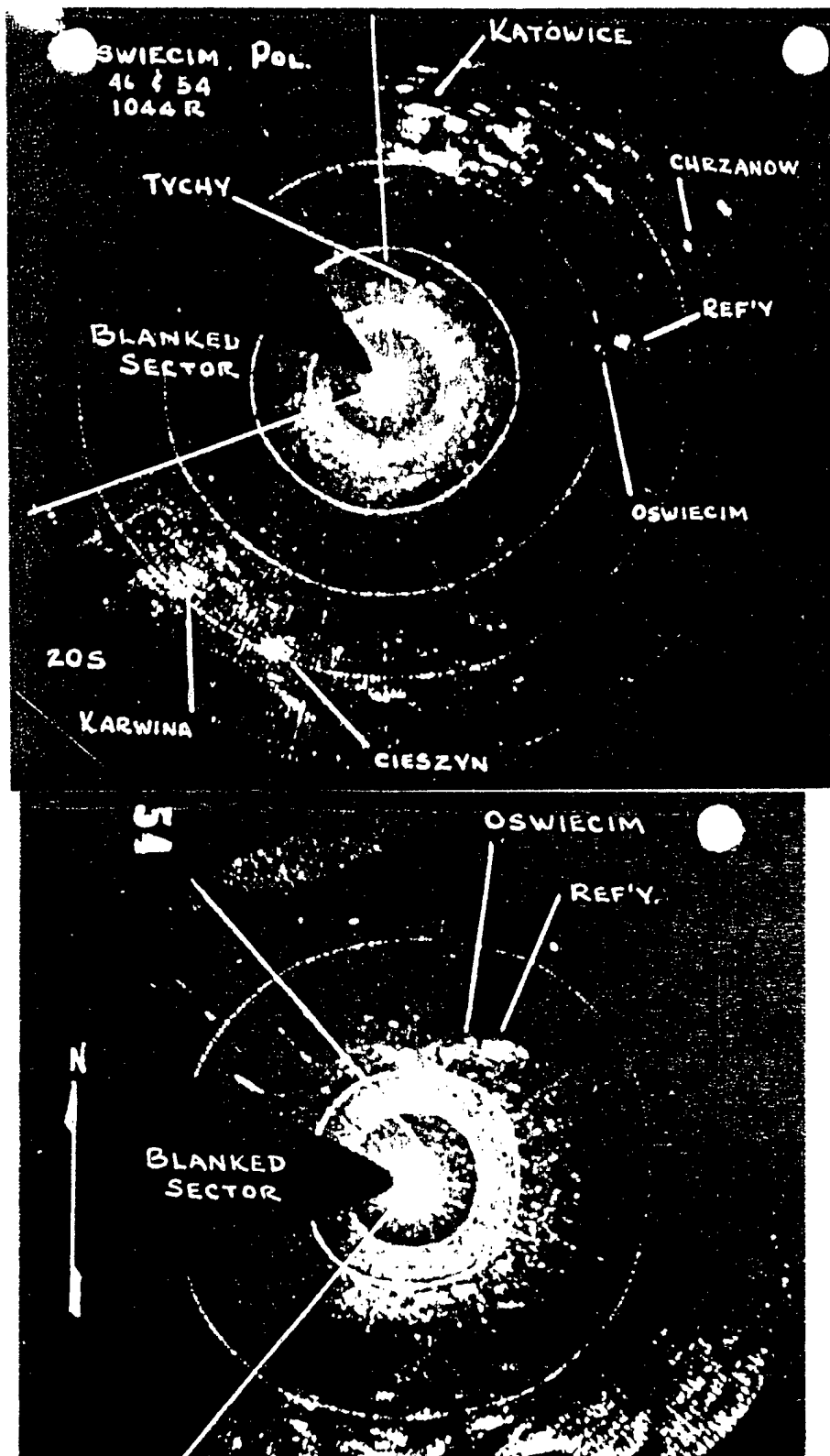
Figure 9: Pathfinder Radar Image Reproductions¹¹⁸¹¹⁸ Personal Files of Milton Groban.

Radar methods, being in their infancy in World War II, represented crude images compared to today's systems. To improve on accuracy, the air forces developed a system called PFF-Synchronous bombing. The system required close communication between the radar-bombardier and a visual bombardier and was usually used when broken clouds or smoke partially obscured the targets. The visual data, being more reliable, supplemented Pathfinder information. The PFF-Synchronous method improved in accuracy as the cloud-cover diminished (hence additional visual updates).¹¹⁹

Visual bombing remained the most accurate way to bomb. Radar bombing could not have been used to attack a target such as facilities at Auschwitz-Birkenau. A simple examination of the radar scope-view of the Oswiecim area proves this point. Due to this mission's inherent concern for collateral damage to the prisoners, the bombers would have relied on the most accurate methods. Therefore, the attack would require good weather.

Bombing tactics greatly affect bombing accuracy. Bomber formations varied from three- to twelve-bomber fronts. Target nature and size, among other factors, determined the formation employed. Using the dimensions and length of the bomb run, the axis of approach and target line presented a target area approximately 350 feet wide and 2800 feet long perpendicular to the buildings' lengths. The three-aircraft front would not only minimize the width of the bombs possibly falling on prisoners' barracks, but provided the best accuracy for smaller targets. Operational analysis demonstrated that compared to a nine-aircraft front, a three-bomber front would place 46% more bombs against a 400-foot wide target. Also, crossing the targets did not drastically decrease accuracy. For a 400

¹¹⁹ First Operations Analysis Section, Fifteenth Air Force, Report on PFF-Synchronous Bombing—Fifteenth Air Force, 20 September 1944. USAFHRA File Number 670.310-1.

foot-wide target, attacking down the length improved accuracy by only five bombs per 400 dropped.¹²⁰ Also, the three-wide formation provided the smallest pattern width, 880 feet.¹²¹ Due to the size of the oil refinery, most formations used a six aircraft front. However, target size and the importance of bomb width dispersion would dictate a smaller three-front formation when attacking Birkenau.

¹²⁰ First Operations Analysis Section, Fifteenth Air Force, Optimum Tactics for Current Level of Bombing Accuracy, 23 October 1944. USAFHRA File Number 670.310-1, p. 5.

¹²¹ First Operations Analysis Section, Fifteenth Air Force, Bombing Accuracy – Aiming Errors and Pattern Dimensions, 31 October 1944. USAFHRA File Number 670.310-1, pp. 1-2.

Figure 10: Aircraft Formations and Advantages¹²²

RELATIVE EFFICIENCIES OF FORMATION ON TARGETS OF VARIOUS SIZES

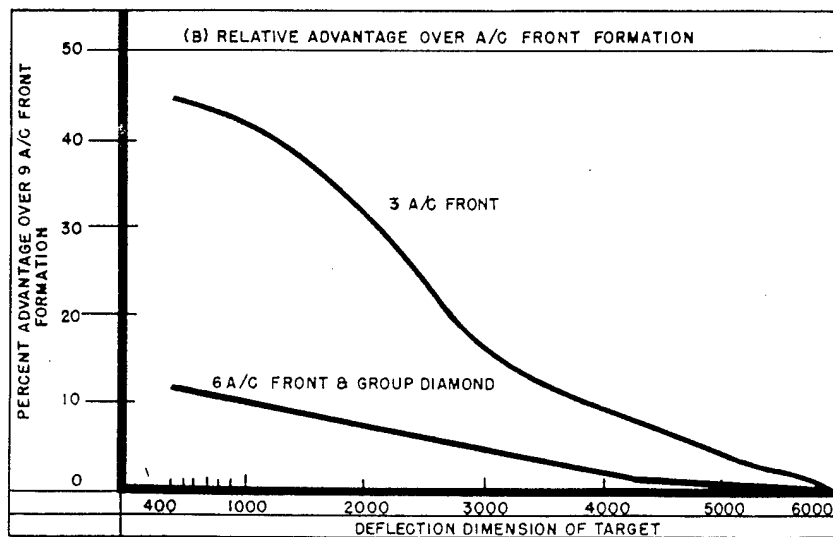
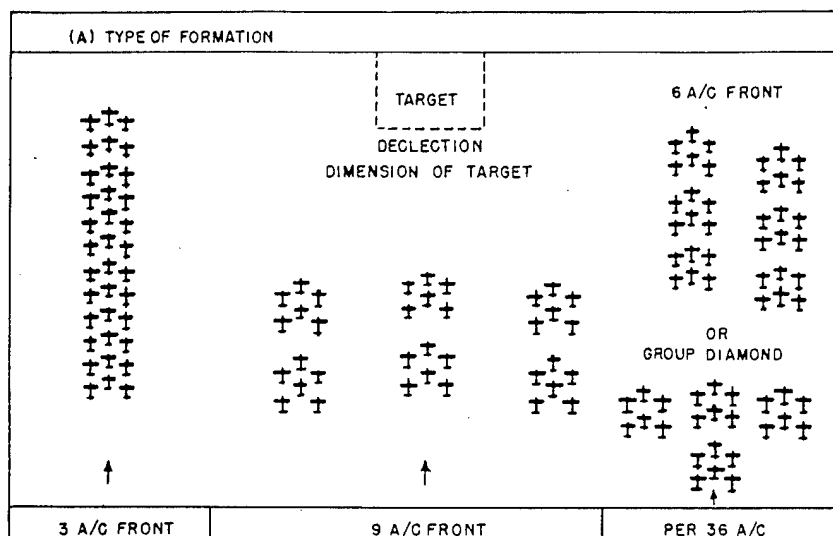

¹²² Reprinted From: First Operations Analysis Section, Optimum Tactics for Current Level of Bombing Accuracy, 23 October 1944, USAFHRA File Number 670.01-3C Annex 19, p. 7.

Figure 11: 15th Air Force Formation Accuracy¹²³

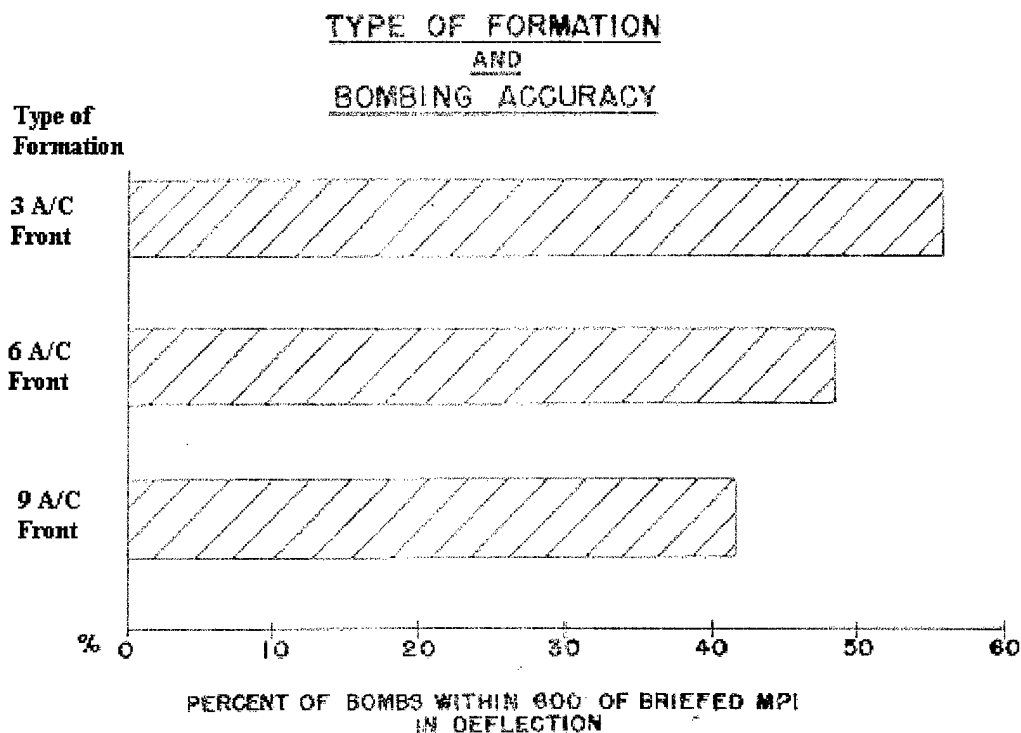

So far the evidence demonstrates that any attack against the Birkenau killing facilities would have required a daylight clear-weather attack, by a small-front bomber formation, attacking perpendicular to the target. Although representing the best available tactics, these measures would not have guaranteed that the barracks area would not receive damage. Analyzing the 15th AF bombing statistics from the summer and fall of 1944 provides the best means of anticipating collateral damage.

The following statistics do not represent a circular-error probable (CEP). Kitchens used CEP, and this can cause confusion in the statistical analysis when comparing measuring accuracy. Therefore, this study will adopt the direct percentage method used

¹²³ Reprinted From: First Operations Analysis Section, Fifteenth Air Force, Bombing Accuracy – Aiming Errors and Pattern Dimensions, 31 October 1944. USAFHRA File Number 670.310-1.

by 15th AF. If 15th AF quotes an accuracy rate of 40% for a 1,000 foot circle, then out of 100 bombs dropped, 40 landed within 1,000 feet of the Mean Point-of-Impact (MPI).¹²⁴

From July to December 1944, 15th AF averaged putting 40.1% of its bombs within 1,000 feet of the MPI. In addition, the best months were July to September, with 41.7% accuracy. The best wing, 47th BW, placed 49% within the 1,000 foot circle. On the contrary, the worst wing, 304th BW, produced only a 22.4% showing. The only period exceeding the accuracy rate for this quarter was March 1945, when 15th AF placed 51.6% of its bombs within 1,000 feet.¹²⁵

Drawing the circle even smaller, to 600 feet, the command put 20.9% of its bombs “on target” between July and September. In the smaller target area, the 55th BW surpassed the 47th BW in accuracy by 0.2% with 25.2%. As with the 1,000 foot circle statistics, only March 1945, with 28.8%, surpassed the July-September period.¹²⁶ The high accuracy rates correspond to 15th AF’s most intense flight activity. Bombers flew 20,845 sorties in August 1944, and posted 15th’s highest effective sortie rate (percentage of bombers airborne to those arriving in the target area and dropping their ordnance), 88%.¹²⁷

¹²⁴ Twenty-Eighth Statistical Control Unit, Fifteenth Air Force, The Statistical Story of the Fifteenth Air Force, USAFHRA File Number 670.308-2, p. 11.

¹²⁵ First Operations Analysis Section, Fifteenth Air Force, Bombing Accuracy, 30 April 1945, USAFHRA File Number 670.56-2.

¹²⁶ *Ibid.*

¹²⁷ The Statistical Story of the Fifteenth Air Force, USAFHRA File Number 670.308-2, p. 12.

Figure 12: Bombing Accuracy, July - December 1944¹²⁸

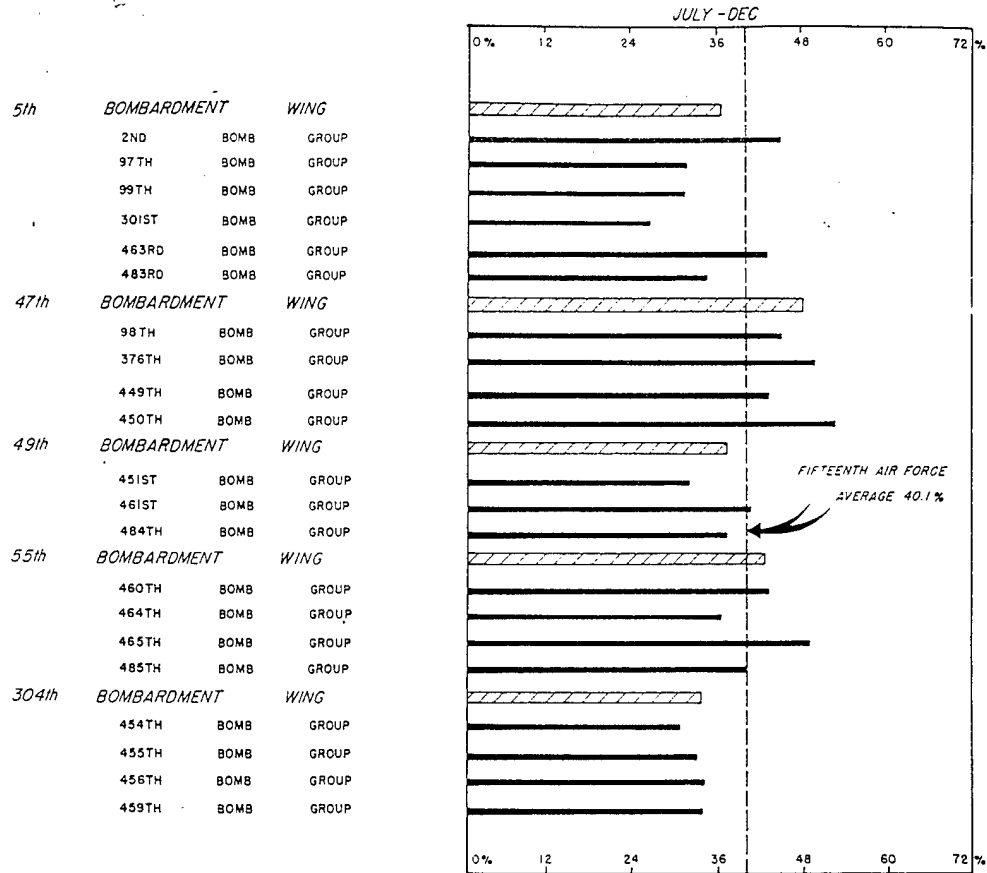
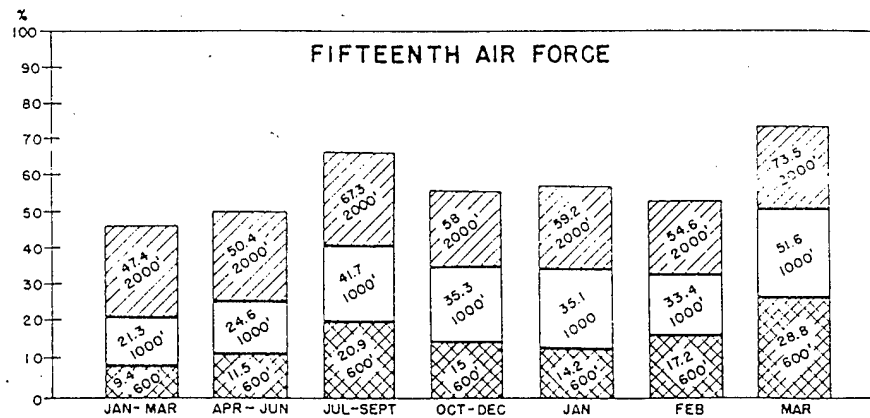
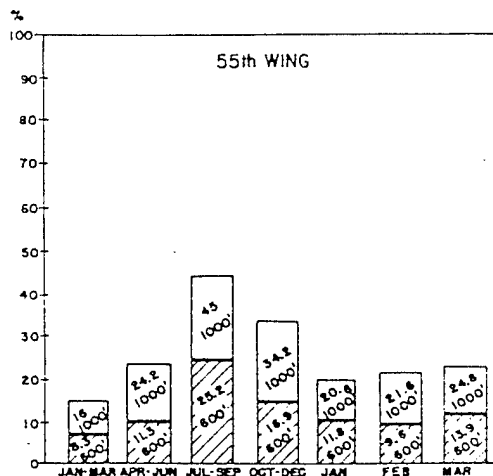
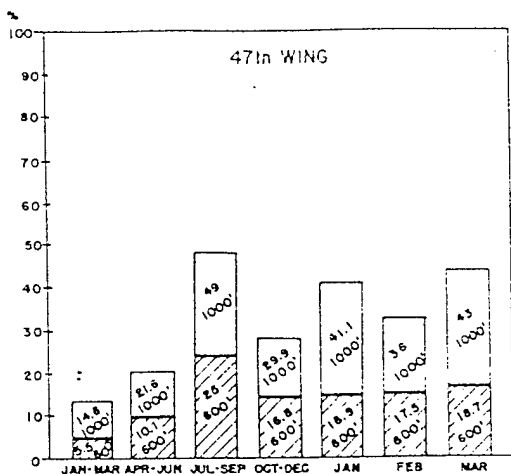

Figure 13: Bombing Accuracy 15th Air Force and Selected Wings¹²⁹



¹²⁸ Reprinted From: First Operations Analysis Section, Fifteenth Air Force, Bombing Accuracy, 30 April 1945, USAFHRA File Number 670.56-2.

¹²⁹ Ibid.



Overlaying 600 and 1,000 foot circles over a diagram of Birkenau aids in demonstrating these accuracy statistics when applied to the camp. The 600 foot radius does not include any additional buildings, ^{and 1,000 ft} and the 1,000 foot circle adds nine barracks in Block BII, and one-third of the "Canada" loot storage facility. Using the earlier computations requiring 400 bombs to have a 60-64% chance of hitting the target, this means that, between July and September 1944, 233 bombs would fall somewhere outside 1,000 feet. If 15th AF had sent one bomb wing to attack Birkenau, with each group targeting one building, then 163 bombs would have fallen outside the circle.

These statistics do not tell the whole story. Using these alone (as Kitchens and Foregger did), one could argue that bombing could decimate the camp's housing areas. Recall the statistics presented earlier, and overlay a three-bomber pattern width of 880 feet (this also came from August and September 1944 mission statistics). Overlaying this width on the diagram demonstrates a greatly reduced threat of bombs decimating the camp.

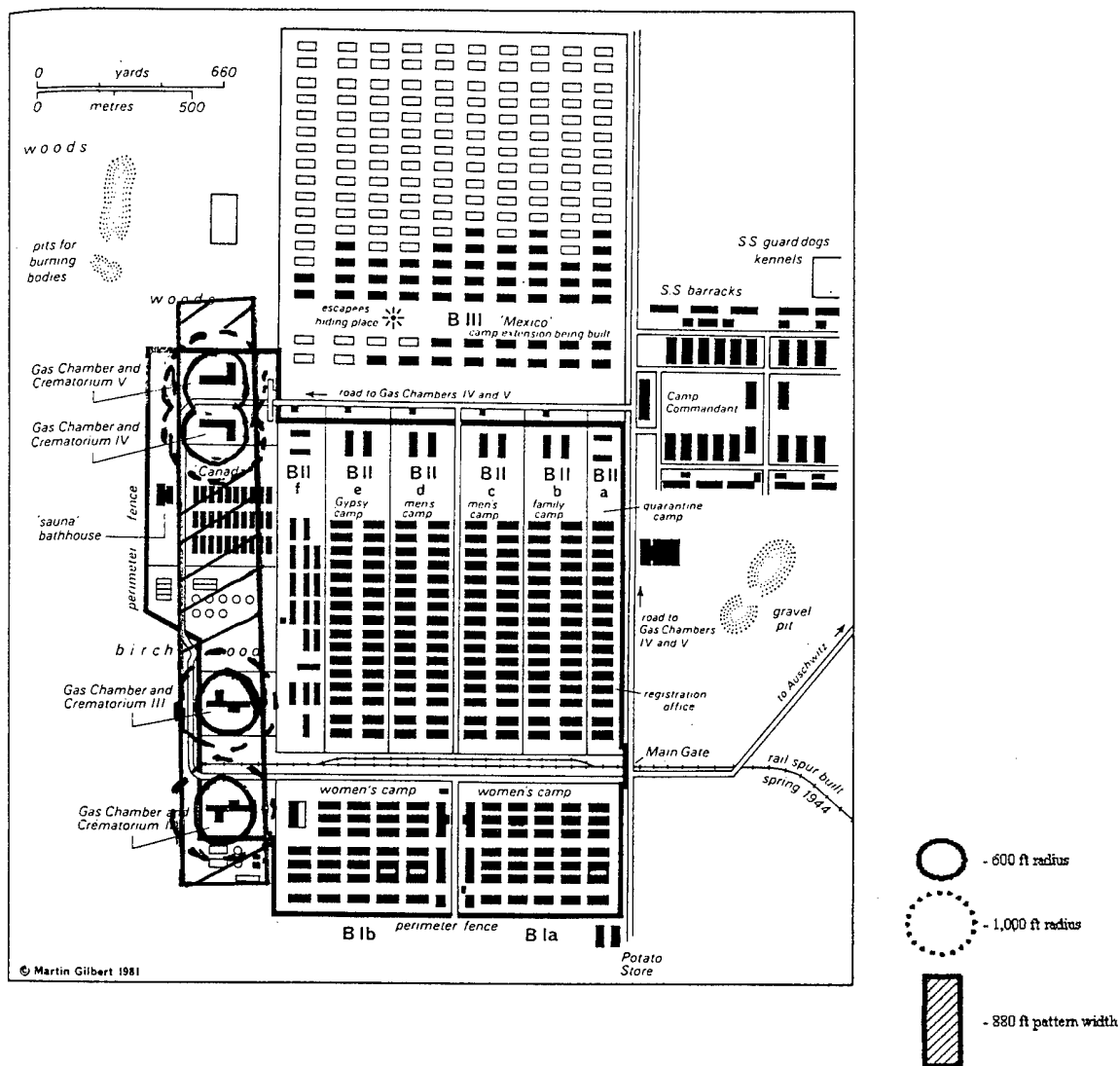
Figure 14: Gilbert Sketch with Overlay¹³⁰

Also, by analyzing other attacks' bomb plots, the majority of the stray bombs fell parallel to the flight path. In other words, they impacted long or short of the target rather than at great widths from the target.

¹³⁰ Gilbert, *Auschwitz and the Allies*, p. 195 and author's overlay.

Figure 15: Bomb Plot of Dubova Attack¹³¹



Note: Each white dot represents a bomb impact. MPI is in center of circles. Circles represent 1,000 feet (58% of bombs), and 2,000 feet (85% of bombs). Attack was with a six-bomber front. Note bomb impacts at far left of photo. Attack altitudes ranged from 18,700 to 19,500 feet.

These statistics demonstrate the feasibility and probability of success while limiting the amount of danger to the inmates. Still, these are only statistics. Any attack on the camp carried with it a probability of killing inmates who might have survived the war (and in some cases did). Only a minor error in deflection aiming (in this case, aiming bombs to

¹³¹ Bomb Plot Analysis, 304th BW attack on Dubova Oil Refinery, 20 August 1944, USAFHRA File Number 670.56A.

the right of the intended target) could lay the pattern of bombs down the center of the camp. Even the tightest patter would have stray bombs that could hit the camp. Also, even with a good run described above, the "Canada" storage area would have been in danger. Many prisoners worked there, and the area, although dangerous, provided inmates with the best chance in securing food and barter items of any work detail.¹³²

Above all, however, the four buildings at Birkenau represented the largest and most apparent danger to all inmates, and to people still arriving. Kitchens and Foregger point out that the bombing would also take-out the rail link where, on a day-to-day basis, a large concentration of prisoners arrived. However, the majority of those arriving, like the Hungarian Jews, went straight to the gas chambers. In addition, these represented the perceived weakest and those not fit for work (young, old, and many women). Although the survival rate for the remainder was low, it was higher than the survival rate of the gas chambers.

¹³² See Vrba, I Cannot Forgive, pp. 124-140.

CHAPTER THREE

BOMBING ALTERNATIVES

Had the political and military authorities decided to bomb Birkenau, 15th AF by no means represented the only option. Alternatives included using Twelfth Air Force's (12th AF) medium bombers, the P-38 Lightning fighter-bomber configuration, or the RAF's de Havilland D.H.98 Mosquito Mk-VI. Each had its own strengths and weaknesses. Additionally, the prospect of bombing the railroads deserves attention. Not only did the Jewish authorities of the time propose striking these routes to the death camps, the idea has resurfaced in historical literature, as discussed in Chapter One. While eliminating the possibility of killing Jews in the camps, railroad bombing required significant resources without a good probability of success.

TWELFTH AIR FORCE

If political pressure had caused the European and Mediterranean leaders to examine the best means to bomb Birkenau, they would most likely have considered using 12th AF, as it was an available asset. However, they would probably have just as quickly realized its bombers could not be used. Because the tactical air force directly supported ground troops, Eisenhower and the ground leaders would have protested taking these planes from their missions when other bombers in 15th were available. In addition, they provided only minimal increase in accuracy, while carrying a smaller bomb load to the extreme of their combat range.

Once the dominant air power in the Mediterranean, 12th AF began losing combat power with the activation of 15th AF. By mid-1944, 12th AF contained no heavy bombers. During the January 1944 USAAF in Europe's reorganization, 12th became a tactical air force assigned the mission of supporting ground troops with its medium bombers, fighter-bombers, and fighters. The air force chain-of-command in the Mediterranean theater began with Eaker, MAAF commander, descended through the Mediterranean Allied Tactical Air Force (MATAF), reaching down to 12th AF, commanded by General John K. Cannon.¹

Throughout the first half of 1944, 12th AF supported the 5th Army in Italy. Its air units aided ground forces by supporting operations around Anzio, and eventually provided key air support as the 5th Army slugged its way into Rome. The 5th Army's commander, General Mark Clark, sent a message to Cannon stating that the 12th "had enabled us to show the enemy how irresistible the air-ground combination can become."² The 12th then went on to support both the 5th and 8th Armies as they made their way north up the Italian peninsula.

By 15 May 1944, the 12th AF controlled only two bomb wings, the 42nd and the 57th. Each wing contained three groups of four squadrons. The 42nd BW flew the B-26 Marauder, while the 57th BW flew the B-25 Mitchell. The 57th BW flew from bases on the northeast side of Corsica, while the 42nd BW staged from Sardinia's southern tip.³

¹ Craven and Cate, vol III, pp. 326-329.

² Message to General John Cannon from General Mark Clark, 5 June 1944, quoted in U.S. Army Air Forces, The 12th over the Mediterranean, USAFHRA File Number 650.107.

³ 23rd Statistical Control Unit, Twelfth Air Force Statistical Handbook, 15 May 1944, USAFHRA File Number 650.125-1.

(MASAF). The medium bombers, occupied with supporting the armies in Italy, did not attack their first ANVIL targets until 2 August. From the invasion through 28 August, the medium bombers remained allocated to supporting the invasion. After that date, and throughout the remainder of 1944, they split their effort between France and Italy.⁵

If a bombing effort had been planned against Birkenau, air leaders would probably have not chosen 12th AF because of its aircrafts' ranges and payloads. Both the B-25 and B-26 carried only six 500-pound bombs. Although a special rack allowed them to carry eight, the extra weight decreased their range even further and could not be used.⁶ Therefore any mission with this aircraft would reduce the chances of destroying the gas chambers and crematoria to less than 40% (using bombing statistics from Chapter 2).

The B-26 could not reach Upper Silesia from any available base anyhow. Its combat range with 3,000 pounds (six 500-pound bombs) extended only 1150 miles, or a maximum target radius of 575 miles.⁷ A round-trip flight to Oswiecim covered approximately 1820 miles from their bases in Sardinia. Moving the planes to stage from 15th AF bases around Foggia still required a 1400 mile mission. Lack of adequate range also eliminated two of the three fighter-bombers: the Douglas A-20 Havoc, and the North American A-36 Mustang IA, a converted P-51.⁸ (The P-38 is discussed later.)

Thus, the B-25 represented the only 12th AF aircraft capable of making the trip. Different variants of the B-25 accounted for slightly varying ranges. However, the most widely used Mitchell was the B-25J (included in 12th AF orders-of-battle), which could

⁵ Craven and Cate, vol III, pp. 415-443.

⁶ Ray Wagner, American Combat Planes, 3rd ed. (Garden City, NY: Doubleday & Company, Inc., 1982), pp. 220-228.

⁷ Ibid, pp. 224-228.

fly 1350 miles with a 3,000-pound bomb load.⁹ The approximate 700 mile distance from its Corsican bases meant the bomber could not make the trip from there. If used, the best option would have been staging them from 15th AF bases around Foggia. Even there, the round-trip of approximately 1200-1300 miles would have pushed their endurance to the limit.

The potential advantage of using the B-25 derived from its improved accuracy over that of the heavy bombers. The 57th BW's B-25s dropped 12,308 tons of bombs in July through September 1944 and placed 77.1% within 600 feet of the target. Of these months, September offered the highest average, 82.2%.¹⁰ Most targets for the 12th AF were in France and Italy, as mentioned above. Targets in these figures represent some of the longest range missions for the 57th, the Italian Po Valley and the Brenner Pass, an approximate radius of 330 miles (660 mile range). Any mission to Birkenau represented an almost doubling of their mission time and range. While shown to be extremely accurate compared to the 15th AF, it is prudent to assume the accuracy would suffer slightly because of the increased distance. In addition, part of the reason for the medium bombers' improved accuracy was that they bombed from lower altitudes. Flying at lower altitudes, however, increased their exposure to more accurate and intense flak, making the mission more dangerous, and the increasing the possibility of higher losses.

While the medium bombers offered better accuracy, it remains doubtful that they would have been used. Although the mediums had a better statistical chance of putting

⁸ Ibid, pp. 172-178 and pp. 185-186

⁹ Ibid, p. 222.

¹⁰ Fifty-Seventh Bomb Wing, Bombing Accuracy in the 57th Bomb Wing, USAFHRA File Number WG-57-SU-RE.

the bombs on target, their bomb load significantly reduced the chance of destroying the facilities. In addition, the ground commanders, as shown by General Clark's remarks, regarded tactical air power as a necessity. Even after the war, when the devastating impact of strategic bombing could be seen throughout Germany, Army generals believed that tactical air power made more significant contributions than strategic bombing.¹¹ In 1944 Eisenhower fought hard to keep strategic bombers available for ground support use under his command, but he lost out to a CCS decision.¹² Fighting so hard to keep control of the heavies, it is highly unlikely he would have allowed a whole group of mediums to be detached for a mission whose range and difficulty was more suited to 15th AF.

BOMBING THE RAILROADS

Bombing the railways that fed Birkenau offered the only way to ensure not killing prisoners with Allied bombs. As noted earlier, the multiple Jewish requests to save Hungarian Jews asked not only for the destruction of the killing facilities, but also for bombing of the main railroad lines from Budapest north. Several factors require consideration. First, the rail resources required were small, and multiple routes existed to take the prisoners north. Although safer in terms of eliminating collateral damage, stopping rail traffic required massive amounts of sorties, often with minimal return. The bombing assets required would be immense, especially given the German's ability to

¹¹ Mark Clodfelter, The Limits of Air Power: The American Bombing of North Vietnam (New York: The Free Press, 1989), p. 11.

¹² Stephen E. Ambrose, The Supreme Commander: The War Years of General Dwight D. Eisenhower (Garden City, NY: Doubleday & Company, Inc., 1970), pp. 499-500.

repair railroads. Finally, possible German responses must be examined, especially in light of the priority given prisoner transportation.

Germans primarily used two types of freight cars in and out of Auschwitz: the open freight car, and the covered freight car. On 30 June 1944, the Deutsche Reichsbahn (DRB) contained 453,440 open and 293,425 closed boxcars. Until September 1944, the DRB overcame any shortages of these types of cars with little difficulty. However, the Allied bombing of marshaling yards made difficult the DRB's efforts to send the cars where they were needed.¹³

According to historian Alfred C. Mierzejewski, the transport of Jews to concentration camps represented only a small portion of the DRB's efforts. First, being positioned on heavily traveled routes behind the Eastern Front and in Silesia, they did not require diversionary trips. Second, they received low priority for transport and were pulled by the older and weaker locomotives. Third, the overall volume of cars and locomotives involved (compared to the DRB's economic and military requirements) was minute.¹⁴

The advance transports of Hungarian Jews bound for Auschwitz departed on 27 and 28 April 1944, and the mass deportations began on 15 May.¹⁵ The Allies did not know about the deportations until 23 June. During those five weeks, the Germans had already moved over 435,000 Jews.¹⁶ Unlike the intelligence needs for the camps, the

¹³ Alfred C. Mierzejewski, RE: Auschwitz Logistics, posting to "H-Holocaust" academic Internet mailing group, 31 December 1995.

¹⁴ Alfred C. Mierzejewski, The Collapse of the German War Economy, 1944-1945: Allied Air Power and the German National Railway (Chapel Hill, NC: The University of North Carolina Press, 1988), pp. 200-201.

¹⁵ Hilberg, Destruction of the European Jews, Revised and Definitive Edition, vol. 2, pp. 836-838.

¹⁶ Gilbert, p. 244.

Allies needed no special information to bomb the rail centers, therefore preparation time would be minimal. In addition, the planners and crews were quite familiar, and often adept, at bombing rail targets.

The major problem would be choosing the rail targets. Even by ignoring all of the minor rail routes between Budapest (and northern Hungary) and Auschwitz, cutting traffic on the major routes would have been difficult, if not impossible. Also, the effort would have required significant amounts of sorties and re-attacks. The Czechoslovak representative in Geneva, Dr. Jaromir Kopecky, and Dr. Gerhart Riegner of the World Jewish Congress, submitted a bombing proposal to Washington on 24 June. In addition to asking for bombing the crematoria, they requested attacks on the six main railway lines used for the deportations.¹⁷

Figure 2: Principle Railroad Lines - Hungarian Jew Deportations¹⁸

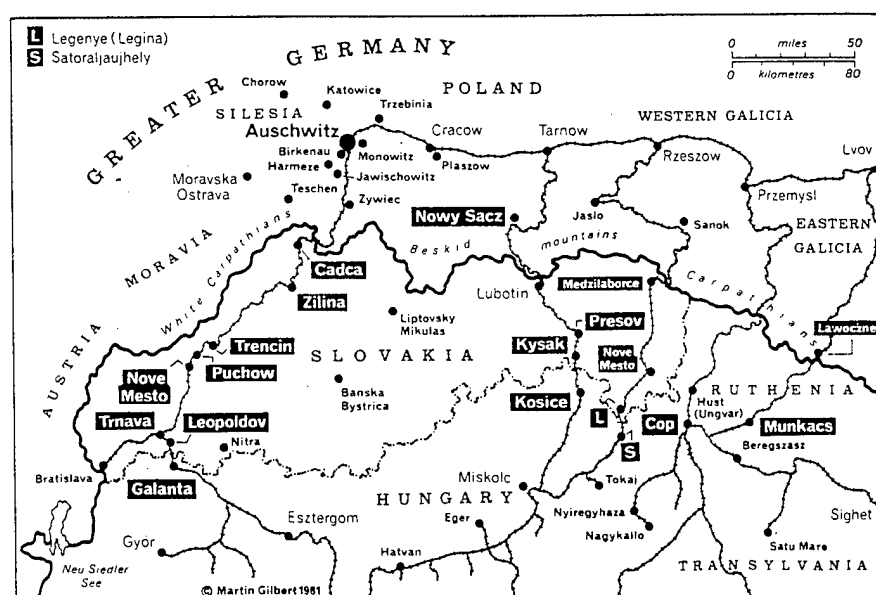

¹⁷ Ibid, p. 246.

¹⁸ Gilbert, *Auschwitz and the Allies*, p. 247.

As will be seen below, railroad tracks themselves, being narrow, required massive amounts of bombs in order to hit them, and repair was rather simple. Therefore, “chokepoints” needed to be targeted to slow or stop rail traffic.

Railroad bridges and marshaling yards became the standard chokepoints for targeting rail traffic. Marshaling yards represented one of the largest efforts of the war according to bomb tonnage dropped by both 8th and 15th Air Forces. During the eighteen months of 15th AF’s war effort, they were the top target in tonnage dropped ten times, and came in second seven times. Overall, marshaling yards received 106,997 tons of bombs, or 34.8% of all bombs dropped by 15th AF.¹⁹ However, the attacks were not always effective.

Generally, bomber crews used the marshaling yard’s geometric center as their aiming point. As a result, some small areas near the entrances (“stump yards”) were left intact. The Germans could have used these areas for high-priority traffic while repairing the main facility. Also, German railroad officials made additional preparations anticipating concerted attacks. Such preparations included operating lines without signals and running opposite the ordinary travel direction.²⁰ Additionally, marshaling yards operated mainly as transshipment areas for freight. Troop movements (and prisoner trains) did not require the main yard area. Troop and prisoner trains could avoid marshaling yards, or only needed one through-track.²¹

¹⁹ David MacIssac, gen. ed., “Air Force Rate of Operation,” 5 November 1945, The United States Strategic Bombing Survey, 10 vols. (New York: Garland Publishing, Inc., 1976), vol. 3, pp. 47-50.

²⁰ Mierzejewski, The Collapse of the German War Economy, p. 41.

²¹ Bernard Brodie, Strategic Air Power in World War II, Research Memorandum RM-1866 (Santa Monica, California: The RAND Corporation, 1957), pp. 22-23.

Fifteenth AF conducted an in-depth analysis of its Verona (Italy) Railway Center attacks. Bombers hit the yards on 28 January, 22 March, and 28 March 1944. The final attack included 110 B-17s, and dropped 330 tons of bombs. The area contained 393 craters requiring repair work, 37 among the through-lines. Although all through-lines remained open, they received top priority for repairs (finished in five days).²² In other areas, the U.S. Strategic Bombing Survey found that when stations became impassable, the passengers walked around destroyed stations and resumed travel on the other side.²³

Bombing bridges, underpasses, viaducts, and tunnels represented the most effective means of interrupting railroad transportation during World War II.²⁴ The routes from Hungary to Auschwitz included many bridges, each differing in size. Bombing accuracy differed according to bridge size. Fifteenth AF's accuracy rate, noted on the chart below, ranged from 19 to 76 percent.²⁵ These results reflect a one-group attack of 36 bombers, each dropping ten 500-pound bombs.

Table 1: Bridge Bombing Probabilities²⁶

| <u>SIZE OF BRIDGE</u> | <u>PROBABILITY OF OBTAINING AT LEAST ONE HIT</u> |
|-----------------------|--|
| 20 x 300 feet | 19% |
| 30 x 600 feet | 46% |
| 30 x 1000 feet | 65% |
| 30 x 1400 feet | 76% |

²² Headquarters Fifteenth Air Force, Operations Analysis Section, Analysis of Bombing - Verona Railway Center, 10 June 1944, USAFHRA File Number 670.310-1.

²³ David MacIssac, gen. ed., "Over-all Report (European War)," 30 September 1945, The United States Strategic Bombing Survey, 10 vols. (New York: Garland Publishing, Inc., 1976), vol. 1, p. 64.

²⁴ *Ibid.*, p. 23.

²⁵ Headquarters Fifteenth Air Force, Operations Analysis Section, Effect of Size and Construction of a Bridge on Probability of Obtaining a Successful Hit, 13 July 1944, USAFHRA File Number 670.01-3C Annex 19.

²⁶ *Ibid.*

From 4 June until 17 July, 15th AF flew 925 sorties, dropped 2,617 tons of bombs, and hit only 11 bridges. For the period from 1 April to 17 July, 15th averaged 91 sorties and 251 tons of bombs for each successful bridge hit.²⁷

Twelfth Air Force collected its figures in greater detail. From 1 June until 31 August, the command's bombers attacked 303 bridges with 5,008 sorties, dropping 9,796 tons of bombs. The effort destroyed 59 bridges, cut or blocked approaches to 88 more, and damaged 92. Of the 303 attacked, 95 remained unscathed.²⁸ Therefore, during this period, 12th AF flew 33 sorties and 65 tons per successful hit (destroyed or damaged). Both the 12th and 15th AF figures represent significant efforts to cut only one bridge. Any attempt to cut enough bridges to preclude movement north by prisoner trains would require a massive effort—and still leave the Germans alternate routes.

Even if viable bridge chokepoints could have been found, the Germans' repair efforts could quickly negate the bombing effort. The 57th BW's report on railroad interdiction stated:

[The] bombing of railroad lines is a continuous struggle between our bombing effort and the enemy repair effort. If rail transport is to be interdicted for a period of weeks, or even months, not individual attacks, but a continuous sequence of attacks are necessary. The damage done by an individual raid will generally be repaired so fast that, if bombing is not persistently repeated, the only effect will be an occasional delay of enemy supplies.²⁹

²⁷ Headquarters Fifteenth Air Force, Operations Analysis Section, Summary of Bridge Attacks, Fifteenth Air Force, 18 July 1944, USAFHRA File Number 670.01-3C Annex 19.

²⁸ Fifty-Seventh Bomb Wing, Bombing Accuracy in the 57th Bomb Wing, USAFHRA File Number WG-57-SU-RE.

²⁹ Fifty-Seventh Bomb Wing, The Necessary Bombing Effort for Continuous Interdiction of Railroad Lines, USAFHRA File Number WG-57-SU-RE.

Fifteenth AF studied the German Army's repair time for several types and lengths of bridges. Steel bridges, where damage required truss removal, could be repaired at a rate of seven feet per day (working during daylight only) to allow single track traffic. Masonry bridges, with arches and piers destroyed and using spans over 100 feet long, averaged eight feet per day (daylight work only).³⁰

Targeting bridges to interdict the trainloads of Jews would, therefore, most probably have been discarded as an option. To be sure, it could have been done quickly (during the last week of June and early July), and would have eliminated the danger of stray bombs killing Jews in the camps. However, by the end of June, most of the Hungarian Jews had already been deported. Additionally, the Germans could have taken many different measures. The redundant railroad network offered alternative routes, or trains could have been routed around the damage. Any delay in the trains only made Jews on those trains suffer more, and would probably have arrived at Auschwitz anyway. Other instances of delayed trains caused Jews to remain standing with no food, water, access to toilets, and in sometimes harsh weather conditions (extreme heat or cold). The Germans could also have diverted the trains to other killing areas, or use "death marches" like those of 1945 during the camp evacuations. Any attempt to bomb railways to save the Jews would have required a tremendous effort with little hope of success.

³⁰ Headquarters Fifteenth Air Force, Operations Analysis Section, The Repair of Railroad Bridges by the German Army, 5 May 1944, USAFHRA File Number 670.635-1.

THE P-38 LIGHTNING

The growing scale of ground attack and fighter-bomber sorties in Europe led to the modification of some P-38Ls and P-38Js. These planes contained a transparent nose with a station for a lead bombardier, and were meant to lead other P-38 fighter-bombers to the target and guide them to the release point.³¹ Both suffered from having short ranges with a bomb-load, lack of adequate training and use on missions, and inaccuracy.

The P-38L modification included the APS-15 Pathfinder radar.³² The effectiveness of the PFF, discussed in Chapter Two, limited accuracy, but could have been used for a Birkenau mission provided the bombardier used only visual sighting. The range remains the limiting factor; it could only fly 450 miles with a 3,200-pound bomb load.³³ A reduction in bomb load could extend the range to where the aircraft could reach Upper Silesia.

Both 8th and 15th AFs used the P-38J "Droopsnoot" modification, and reported on their effectiveness. Eighth AF remarked that the plane could only accurately bomb large area targets, such as airfields.³⁴ Against bridges, single buildings, and small targets, the 8th AF report stated, "the density of the bomb pattern varied to an extent that made results on pinpoint targets less satisfactory than those obtained by heavy and medium bombers."³⁵ Instability, sluggishness, small bomb load, and lack of proper crew training or mission experience were other problems noted. Also, due to carrying the bombs,

³¹ Gordon Swanborough and Peter M. Bowers, United States Military Aircraft since 1909 (Washington, DC: Smithsonian Institution Press, 1989), p.362.

³² Wagner, pp. 264-265.

³³ Ibid.

³⁴ Headquarters Eighth Air Force, Office of the Commanding General, Evaluation of Operational Use of Droopsnoot Aircraft, 11 March 1945, USAFHRA File Number 245.606-2, p. 1.

³⁵ Ibid, p. 2.

Droopsnoot formations still required the same amount of fighter protection afforded the bombers.³⁶

The 15th AF report came to the same general conclusions as the 8th. It used the Droopsnoot against bridges, troop concentrations, oil refineries, marshaling yards, and industrial plants. Additionally, 15th recommended only attacking targets not requiring heavy bombs, defended by only light flak, and within a 500-mile range.³⁷ From 1 August 1944 to 21 January 1945, 15th AF Droopsnoots conducted 21 attacks (only 2 in August and one in September), usually flying at an altitude of 15,000 feet. Only one recorded “excellent” results.³⁸ The command considered the plane “a valuable, though relatively minor, adjunct to the strategic employment of the Air Force.”³⁹

The maximum range and payload data for the P-38J matched those of the Pathfinder P-38L.⁴⁰ They could be used at longer ranges, but only with smaller loads. Loaded with four 500-pound bombs, the aircraft could travel out to 500 miles.⁴¹ To reach Birkenau, the planes would be limited to two bombs.

Due to their limitations, the P-38 fighter-bombers must be excluded as a viable option for such a mission. To drop the required number of bombs to achieve the desired destruction would have required a large formation, and without a significant increase in accuracy over heavy or medium bombers.

³⁶ Ibid, pp. 1-4.

³⁷ Fifteenth Air Force, Report of Employment of Droopsnoot P-38 Aircraft in Fifteenth Air Force, n.d., USAFHRA File Number 245.606-2, p. 1.

³⁸ Ibid, p. 5.

³⁹ Ibid, p. 2.

⁴⁰ Wagner, pp. 264-265.

⁴¹ Fifteenth Air Force, Report of Employment of Droopsnoot P-38 Aircraft in Fifteenth Air Force, p. 2.

THE RAF MOSQUITO

Wyman, Kitchens, Foregger, and Hodges discussed the costs and benefits of using the RAF's DeHaviland D.H. 98 Mosquito. Of all the aircraft capable of bombing the crematoria, this aircraft provided the best chance of success with the least amount of danger to the Jewish inmates. Mosquito bombers conducted many pinpoint attacks during the war—the six most famous involved bombing to save civilian lives.

The Mosquito ranks as one of the most amazing aircraft of World War II. Developed from a private venture, the plane's plywood/balsa construction provided the basis for the nickname "the Wooden Wonder." Although initially viewed with skepticism, the plane became one of the war's most versatile aircraft, performing fighter, fighter-bomber, bomber, night fighter, and photo-reconnaissance missions. The bomber version, the Mk-IV, and the fighter-bomber, Mk-VI, could both carry up to 4,000 pounds of bombs, with the latter's fully loaded maximum operating radius being 535 miles.⁴² The typical Mk-VI combat load included two 500-pound bombs in the internal bomb-bay, with the flexibility of putting two more, or eight 60-pound rockets, on under-wing racks.⁴³

The first daring raid came less than six months after the Mk-IV became operational. On 25 September 1944, four Mk-IV's from No. 105 Squadron took off from Leuchars, Scotland for the Oslo, Norway Gestapo Headquarters. After flying across the North Sea, they flew along the Oslo Fjord, pursued by three Focke-Wulf Fw-190s.⁴⁴ The Germans shot down one Mosquito, but the others placed four bombs through the

⁴² M. J. Hardy, The de Havilland Mosquito (New York: Arco Publishing Company, Inc., 1977), p. 121.

⁴³ Andrew W. Waters, All the U. S. Air Force Airplanes, 1907-1983 (New York: Hippocrene Books, 1983), p. 332.

⁴⁴ Hardy, p. 28.

building's roof. Three bombs passed through the building without exploding, and the fourth, although staying inside the building, also failed to detonate. RAF Bomber Command intentionally timed the raid to coincide with a rally supporting German occupation, and thus raise the Norwegian people's morale.⁴⁵

The next, and most famous, precision raid conducted to aid occupied peoples occurred on 18 February 1944. In January, the British government had received information stating that Germans planned to execute over 100 French resistance fighters at the Amiens jail. The RAF planned to puncture the prison's walls hoping that at least some of the condemned could escape. Using intelligence information, 2 Group planned the attack using a target model, and timed the raid for noon, during the guard's lunch break. Eighteen Mk-VI aircraft from three squadrons prepared for the attack (another photo-reconnaissance Mosquito would film the attack). The 487 Squadron's seven aircraft would attack the prison's north and east walls (20 feet high and three feet thick) and aim bombs at the main prison building's base in order to shake loose the cell's locks. The second wave, 464 Squadron, targeted the German's quarters, and the third wave, 21 Squadron, would act as a backup.⁴⁶

Swirling snow greeted the aircraft as they took-off, and two crews each of 21 and 464 squadrons became lost and abandoned the operation. Fortunately, the weather improved over France. The lead aircraft's bombs pierced the prison's outer walls, and their bombs on the main building succeeded in breaking the prisoner's doors free. The

⁴⁵ Martin Middlebrook and Chris Everitt, The Bomber Command Diaries: An Operational Reference Book, 1939-1945 (New York: Viking, 1985), p. 311-312.

⁴⁶ Michael J. F. Bowyer, 2 Group R.A.F.: A Complete History, 1936-1945 (Boston: Faber and Faber, 1974), p. 353.

464 Squadron's precision attacks also being successful, the mission commander ordered 21 Squadron not to attack.⁴⁷ The losses included two Mk-VI's, one to flak and one to Fw-190s, and two escorting Typhoon fighters. Even with the losses, the mission's success allowed 258 prisoners to escape, including half of those awaiting execution the next day.⁴⁸ The Germans recaptured many of the prisoners, and 102 died from bomb blasts or German machine-gun fire.⁴⁹ Unlike the direct attack on the buildings housing those the aircraft were attempting to rescue, an attack on Auschwitz would put only those in or near the crematoria at risk from bomb blasts.

French Resistance leaders, in a note sent to thank the RAF, learnt that the first bomb blasts blew-in nearly all doors in the prison. Only ten attacking Mosquito fighter-bombers, using 500-pound bombs, achieved their objective with precision accuracy. An Australian navigator, commenting on the raid's objective to save civilians and resistance fighters, said, "This was the sort of operation that gave you the feeling that if you did nothing else in the war, you had done something."⁵⁰ This morale (and moral) dimension also could have applied to an Auschwitz attack—especially if the pilots were informed about the known intelligence concerning the numbers of prisoners killed and the methods used.

The next special attack against a non-military target came on 11 April 1944. One five-story house in the Scheveningsche Wegg, the Hague, Netherlands contained the Gestapo's records on the Dutch Resistance. Six aircraft from 613 Squadron attacked the

⁴⁷ Ibid, pp. 353-354.

⁴⁸ Ibid, p. 354.

⁴⁹ Hardy p. 57.

⁵⁰ Quoted in C. Martin Sharp and Michael J. F. Bowyer, *Mosquito* (London: Faber and Faber Limited, 1967), p. 244.

95-foot tall building with a mix of 500-pound bombs and incendiaries (meant to start fires to destroy the records). Although flood waters made map-reading and terrain matching difficult, the aircraft arrived over the target. The first two fighter-bombers attacked with the high-explosive, 30-second delayed fuzing bombs, while the other four circled over Lake Gouda. The third and fourth aircraft carried incendiaries, and the fourth found target location difficult due to smoke. The fifth Mosquito dropped two explosive and two incendiary bombs, but the sixth did not attack and instead filmed the target.⁵¹

Once again, the Mosquito and its crews achieved spectacular success. Only one aircraft received flak damage.⁵² The attack collapsed the building, and although the attack took place within an urban area during early afternoon hours, not one Dutch civilian outside the building died. Also, only one window in the nearby Peace Palace broke.⁵³

Another mission to aid the Dutch resistance took place on 31 October 1944. The Jutland Gestapo Headquarters occupied two buildings at Aarhus University. Twenty-four Mk-VI's from the same three squadrons that carried out the Amiens prison raid carried out the attack. Flying in four sections, with six aircraft in each section, they dropped 500-pound bombs with eleven second delayed fuzes. The attack destroyed the target, and only one Mosquito did not return to England. It force-landed in Sweden due to damage.⁵⁴

Mosquito Mk-Vs attacked another Gestapo Headquarters, this one in Oslo, Norway, on the last day of 1944. Twelve Mosquitoes of 627 Squadron, 5 Group, set out

⁵¹ Ibid, pp. 244-245.

⁵² Ibid, p. 245.

⁵³ Bowyer, p. 361.

⁵⁴ Hardy, p. 57.

on the attack. Only eight aircraft bombed the target, in two waves of four. The bombs hit the target, and all aircraft returned safely.⁵⁵

The final daring attack again used the three experienced squadrons of Amiens and Aarhus. Known as OPERATION CARTHAGE, they targeted the Shellhaus building in Copenhagen, Denmark. The Dutch Resistance leaders, fearing a German mass arrest plan to paralyze the Dutch underground, requested the attack. On this attack, 21 Squadron would lead the attack, then six Mosquitoes from 464 Squadron, and finally seven from 487 Squadron.⁵⁶ To ensure the maximum number of Gestapo deaths, they planned the attack for the lunch break.

The bombers crossed the sea at very low level, climbed to 200 feet when reaching land, and dropped back down to 100 feet for the attack run. The leading wave's bombs detonated in the building's lower stories, but the fourth aircraft struck a flag pole and crashed into a garage. The second and third waves became misled by the smoke, but the second wave's leader pulled-off and re-attacked the target. Two aircraft, disoriented by the smoke, attacked the garage where the Mosquito crashed. Four of the last wave's aircraft also bombed the crash site, but some of the bombs fell on the Jeanne d'Arc School, killing some children.⁵⁷

Despite bad target weather, and the extremely long trip (five and one-half hours round-trip), they destroyed the target. The building received severe damage, the Gestapo records were largely destroyed, 150 Gestapo men were killed and 30 Dutch prisoners escaped. Flak from ships in the harbor damaged three other Mosquitoes, with two

⁵⁵ Middlebrook and Everitt, p. 641.

⁵⁶ Sharp and Bowyer, p. 256.

ditching in the sea along the return route and one landing in Sweden. A fourth, severely damaged and without hydraulic power, belly-landed at the home base in Fersfield.⁵⁸

These six daring and successful attacks reveal not only the Mosquito's capabilities, but also that the RAF was willing to use these valuable assets for other than bombing strictly military targets. Kitchens, in his 1994 article, stated "no Mosquito fighter-bombers were stationed in the Mediterranean in the summer of 1944, and none could be moved."⁵⁹ While the first part is certainly true, the second statement is presumptuous. With the political will to do so, the Mosquitoes could have accurately attacked the Birkenau facilities—Churchill displayed this will with his comments to Eden.⁶⁰ The RAF could have easily deployed several Mosquitoes to Italy to perform the mission.

Although any Mk-VI unit may have been available, due to their experience in such attacks, the best units to call upon would have been 21, 464, and 487 Squadrons. Using sixteen aircraft, four targeting each crematorium, and each carrying four 500-pound bombs, their proven accuracy provided the best force for such a mission. In the six missions mentioned above, the Mosquitoes only needed a small escort force, due to their agility and speed. The previous attacks used eight fighter escorts, either Typhoons or Mustangs.

⁵⁷ Bowyer, p. 412 and Sharp and Bowyer, p. 256.

⁵⁸ Bowyer, pp. 412-413 and Sharp and Bowyer, pp. 256-257.

⁵⁹ Kitchens, The Bombing of Auschwitz Re-examined, p. 260.

⁶⁰ See Chapter One, and Churchill to Eden, 7 July 1944, PRO FO 371/42809/135 as quoted in Wasserstein, p. 311.

Kitchens also used misleading figures for Mosquito losses.⁶¹ He quoted losses of eight percent per month. Actually, during all of 1944, Mosquitoes of Group 2 (includes the three squadrons above) flew 11,631 sorties with only 110 lost (0.9%) and 196 damaged (1.7%). Of the losses and damaged aircraft, enemy fighters accounted for only one loss. The inclusion of night sorties, when fewer losses occurred, skews these figures lower. Still, of those Mosquitoes flown on daytime raids, 1732 during 1944, only 32 did not return (1.84%), and 146 received damage (8.43%).⁶²

The months from July to October 1944 require examination for a more specific analysis of a hypothetical mission to Birkenau. During these three months, 2 Group flew 191 Mosquito sorties. Only seven aircraft, four in August and three in September, were lost (all to flak) for a 3.6% loss rate. Flak also damaged three planes in August, and two in October (five others damaged in October by unknown causes), for a total damage rate of 4.2%.⁶³ Although these numbers represent significant losses, they are not as high as Kitchens' and did not deter the RAF from using the Mosquitoes on similar operations.

Of all the alternatives discussed in this chapter, using the "Wooden Wonder" offered the best probability of saving Jewish lives at Birkenau. The RAF used the Mosquitoes to save civilian lives, and even flew other non-military missions, such as delivering beer to British troops on the Normandy beaches.⁶⁴ They could have attacked Birkenau with a precision such that collateral losses could be almost negated. As with any military operation, the crews would be at risk—but that was their job.

⁶¹ Kitchens, *The Bombing of Auschwitz Re-examined*, footnote 82 on p. 261.

⁶² Bowyer, p. 473.

⁶³ *Ibid*, p. 474.

⁶⁴ Sharp and Bowyer, p. 250.

CONCLUSION

“We see, therefore,” wrote the great military theorist Carl von Clausewitz, ” that war is not merely an act of policy but a true political instrument, a continuation of political intercourse, carried on with other means.”¹ If nowhere else, the American and British armed forces typified this principle during World War II. Roosevelt and Churchill defined the political goals and directed their military commanders to achieve them. The decision not to bomb Auschwitz rests ultimately with them, although Wyman, Wasserstein, and Gilbert showed how their political bureaucracies stonewalled the Jewish organizations’ fractured efforts to gain military action to save Jewish lives. Regardless of the military leaders’ attitudes or arguments, had either Roosevelt or Churchill pressed the issue, the military would have had to carry out the attack. The September 1944 Allied air-dropping of supplies in Warsaw provides a clear example of the political will dictating military action even when the generals argued against the action.

With the political push for action, the air leaders would have carried out the attack. Certainly any effort represented a “diversion of assets” from strategic targets, but such diversions were not unprecedented. As outlined in Chapter Two, the total effort would have required one mission by one group of heavy bombers. In order to minimize collateral damage to Jewish prisoners, Birkenau could not have been attacked at night or in bad weather. However, any targets it replaced could be attacked in less than optimum weather with systems such as Pathfinder.

¹ Carl von Clausewitz, *On War*, ed. and trans. By Michael Howard and Peter J. Paret (Princeton, NJ: Princeton University Press, 1976), p. 87.

Authors who have considered the military aspects of a possible attack tend to generalize all aspects of any such operation. Kitchens and Foregger use broad representations and generalities to portray the mission as impossible or foolhardy. They used bomber accuracy statistics and information on German defenses from various dates and regions. However, as this study demonstrated, analyzing the situation under specific probable circumstances provides the most effective means of defining the possibilities and characteristics of any possible attack. Therefore, this work focused on the conditions existing, and on bombing missions that actually occurred, between late July and early October 1944.

When narrowed to these months, the historical record reveals that German defenses rarely took a heavy toll on attacking bombers, and strategic bombardment accuracy achieved a high level. During these months, the Luftwaffe mustered its resources, yet did not affect the bomber missions against the Upper Silesian oil facilities. German flak guns, while ever-present and with improving accuracy, did not significantly attrit attacking formations. These months also saw the second highest level of 15th AF's strategic bombing accuracy. The command's statistical analysis unit detailed how lower altitudes and varying formations could offer increased precision.

Regardless of the bombing platform used or the statistical accuracy then available, there existed a chance that the attack would kill Jewish inmates. In order to minimize the collateral damage, the military leaders would have had to pick the best available asset under the existing time constraints. Heavy bombers were able to carry heavy loads over long distances, but their normal operating procedures—high-altitude releases against large target complexes—produced a large bomb pattern unacceptable for bombing

Birkenau. The large bombers of Britain's Bomber Command were accustomed to flying at night against very large urban and industrial targets. Their primary base being in England, both they and the U.S. 8th Air Force, were out of range from Auschwitz-Birkenau.

Using 15th Air Force, the Mediterranean theater's strategic bomber force, would have been the easiest means to attack the gas chambers and crematoria, but it also would have required a large effort with questionable accuracy. Fifteenth AF's B-17s and B-24s could carry the required bomb-load the desired range. Their bombers demonstrated the capability to bomb targets in Upper Silesia in August and September 1944, and these missions demonstrated the ineffectiveness of the Luftwaffe during those months.

If 15th AF had been selected, the mission could have only been performed within a rigid set of circumstances to limit the possibility of decimating the camp. The bombers would have had to use a three-bomber front, with each bombardier acquiring the target, and under clear weather. Only these tactics and conditions could have helped limit stray and inaccurate bombs from hitting the barracks areas. Under these criteria, and using 15th AF's statistical accuracy for August and September 1944, the Allies stood a very good chance of destroying or damaging the Birkenau facilities while limiting the possibility of killing prisoners.

Range and wartime operating procedures reduced the possibility of using the other U.S. assets in the Mediterranean. Save the B-25, the tactical bombers of 12th Air Force did not have the required operating radius to reach Upper Silesia. The only fighter-bomber, the "Droopsnoot" P-38 had the range, but its light bomb load, inaccuracy, and lack of pilot experience eliminated it from serious consideration. Although the B-25

demonstrated better accuracy than the heavy bombers, its crews were not accustomed to flying such long missions. Most importantly, it is extremely doubtful that the commanders, especially the Supreme Allied Commander Dwight D. Eisenhower, would have stripped these tactical assets from their ground-support missions.

Bombing the railroads, while eliminating the possibility of directly killing Jewish prisoners, offered little return for the required large effort. Keeping railroad lines closed required a large number of bombers and multiple re-attacks to offer any chance of eliminating rail traffic. The multiple routes available and the ability to repair the lines relatively quickly (and even faster with captive labor) further reduced the chances that any such operation would save Hungarian Jews.

The de Havilland Mosquito offered the best chance to achieve the mission with the least amount of danger to the prisoners. The Mk-VI version could carry the necessary bomb-load the required range, and had a record of accuracy unmatched in World War II on such missions. Three squadrons of 2 Group had demonstrated their abilities throughout 1944, and their movement to Italy would have required only the political will to do so. Churchill, with a documented interest in the bombing requests, could have provided the necessary political power.

Without decisive political intervention to attack these non-militarily essential targets, American and British military leaders continued with their plans to achieve the Third Reich's destruction by the best and fastest means possible. Whereas bombing offered only a possible reprieve for Jewish prisoners, destroying Hitler's grip on Europe guaranteed a means for saving Jews.

Bibliography

Primary Sources

Library of Congress Manuscript Division

Carl Spaatz Collection:

Box 14, Personal Diaries.

Box 16, Personal Diaries.

Box 18 Official Diaries.

Box 139, Occupied Countries.

Ira Eaker Collection:

Box 22, Correspondences with General Henry H. Arnold, Vol 2, 1 May 1944 - 31 August 1944.

National Archives

Record Group 165, Records of the War Department General and Special Staffs Civil Affairs Division, 383.7

Blaustein, Jacob. Letter to Honorable Henry L. Stimson. 12 February 1944.

Hilldring, J. H. Cover Letter to Secretary of War. 16 February 1944.

Hilldring, J. H. Memorandum to Secretary of War. 22 August 1944.

Pehle, J. W. Letter to Major General J. H. Hilldring. 4 September 1944.

Ulio, J. A. Letter to Union of Orthodox Rabbis of the United States. 24 August 1944.

U.S. President. Executive Order 9417, "Establishing a War Refugee Board." 22 January 1944.

U.S. Air Force Historical Research Agency (Maxwell AFB, Alabama)

Downey, Marvin, ed. Fifteenth Air Force, History. Wright Field, Dayton, Ohio:
Headquarters Air Material Command, 1946. . USAFHRA File Number 670.01-1
Vol. 1, c.1.

Individual Messages and Reports from following USAFHRA File Numbers:

245.606-2
519.308-1
650.107
650.125-1
670.01-3C, Annex 19
670.56A
670.56-2
670.56-3
670.308-2
670.310-1
670.310-6
670.317-3, Vol 1
670.332
670.635-1
670.6012-63
670.6012-67
670.6012-68
WG-57-SU-RE

Oswiecim Synthetic Oil and Rubber Work, Poland. Target Information. USAFHRA File
Number 670.424.

Statistical Control Office, USSTAF. Daily Operations Report, Eighth and Fifteenth Air
Forces. USAFHRA File Number 519.308-2.

U.S. Holocaust Research Institute

McClelland, Roswell. Message to WRB. Number 4291, 6 July 1944. Copy contained in
Subject File: Camps - Auschwitz Bombing to Camps - Auschwitz WRB Report.

McClelland, Roswell. Message to WRB. Number 4295, 6 July 1944. Copy contained in
Subject File: Camps - Auschwitz Bombing to Camps - Auschwitz WRB Report.

OSS Report, 15 October 1943. Copy contained in Subject File: Camps - Auschwitz

Office of Strategic Services. No title, numbered as 09468. Copy contained in Subject File: Camps - Auschwitz.

U.S. Executive Office of the President. War Refugee Board. German Extermination Camps – Auschwitz and Birkenau. November 1944. Copy contained in Subject File: Camps - Auschwitz Bombing to Camps - Auschwitz WRB Report.

Personal Interviews and Correspondence

Groban, Milton. Personal Combat Diary.

Groban, Milton. Personal letter to author, 12 May 1996.

Groban, Milton. Glencoe, Illinois. Interview 22 June 1996.

Hill, Sedge; Anderson, Dick; Christianson, Gale; and Parks, John. 451st Bombardment Group Reunion, Fairmont Army Airfield, Fairmont, Nebraska. Interviews, 15 June 1996.

Mierzejewski, Alfred C. RE: Auschwitz Logistics. Posting to “H-Holocaust” academic Internet mailing group. 31 December 1995.

Thomas, Gary, Captain, USAF. Telephone Interview. 3 October 1996.

Memoirs and Official Publications

Casey, Dennis F. and Davis, James R. Vezzano to Desert Storm: History of Fifteenth Air Force, 1943-1993. N.p.: Department of the Air Force, [1991].

Churchill, Winston S. Memoirs of the Second World War. Boston: Houghton Mifflin Company, 1987.

Craven, Wesley F. and Cate, James L., eds. The Army Air Forces in World War II. 7 vols. Chicago: The University of Chicago Press, 1949. Vol. 2: Europe: TORCH to POINTBLANK.

_____. The Army Air Forces in World War II. 7 vols. Chicago: The University of Chicago Press, 1949. Vol. 3: Europe: Argument to V-E Day, January 1944 to May 1945.

Lane, Authur Bliss. I Saw Poland Betrayed; An American Ambassador Reports to the American People. Indianapolis: Bobbs-Merril Co., 1948.

MacIssac, David, gen. ed., "Summary Report (European War)." 30 September 1945. The United States Strategic Bombing Survey, 10 vols. New York: Garland Publishing, Inc., 1976. Vol. 1.

_____. "Air Force Rate of Operation." 5 November 1945. The United States Strategic Bombing Survey. 10 vols. New York: Garland Publishing, Inc., 1976. Vol. 3.

Maurer, Maurer, ed. Air Force Combat Units of World War II. Washington, D.C.: Office of Air Force History, 1983.

U.S. War Department. Technical Manual: Handbook for Bombardiers. TM 1-251. 31 March 1945.

Vrba, Rudolf, and Bestic, Alan. I Cannot Forgive. New York: Grove Press, Inc., 1964.

Secondary Sources

Books

Ambrose, Stephen E. The Supreme Commander: The War Years of General Dwight D. Eisenhower. Garden City, NY: Doubleday & Company, Inc., 1970.

Bauer, Yehuda. A History of the Holocaust. New York: Franklin Watts, 1982.

Blum, John Morton. V was for Victory: Politics and American Culture During World War II. New York: Harcourt Brace Javanovich, 1976.

Brodie, Bernard. Strategic Air Power in World War II. Research Memorandum RM-1866. Santa Monica, California: The RAND Corporation, 1957.

Brugioni, Dino A. and Poirier, Robert G. The Holocaust Revisited, a Retrospective Analysis of the Auschwitz-Birkenau Extermination Complex. Washington, D.C.: Central Intelligence Agency, 1979.

- Bowyer, Michael J. F. 2 Group R.A.F.: A Complete History, 1936-1945. Boston: Faber and Faber, 1974.
- Clausewitz, Carl von. On War. Edited and translated by Michael Howard and Peter J. Paret. Princeton, NJ: Princeton University Press, 1976.
- Clodfelter, Mark. The Limits of Air Power: The American Bombing of North Vietnam. New York: The Free Press, 1989.
- Druks, Herbert. Failure to Rescue. New York: Robert Speller & Sons, Publishers, Inc., 1977.
- Dwork, Debórah and van Pelt, Robert-Jan. Auschwitz: 1270 to the Present. New York: W.W. Norton & Company, 1996.
- Eban, Abba. My People: The Story of the Jews. New York: Behrman House, Inc., 1968.
- Encyclopedia of the Holocaust. Israel Gutman, Editor-in-Chief. Volume 1 (1990), s.v. "Auschwitz, Bombing of." By David S. Wyman.
- Feingold, Henry L. The Politics of Rescue: The Roosevelt Administration and the Holocaust, 1938-1945. New Brunswick, N.J.: Rutgers University Press, 1970.
- _____. "Review of David Wyman's Abandonment of the Jews: America and the Holocaust, 1941-1945." In FDR and the Holocaust, edited by Verne W. Newton. New York: St. Martin's Press, 1996.
- Gilbert, Martin. Auschwitz and the Allies. New York: Henry Holt and Company, 1981.
- _____. Atlas of the Holocaust. New York: Pergamon Press, 1988.
- Gutman, Yisrael, and Berenbaum, Michael eds. Anatomy of the Auschwitz Death Camp. Bloomington: Indiana University Press, 1994.
- Hansell, Haywood S. Jr. The Air Plan That Defeated Hitler. Atlanta, Georgia: Higgins-McArthur/Longino & Porter, Inc., 1972.
- Hardy, M. J. The de Havilland Mosquito. New York: Arco Publishing Company, Inc., 1977.
- Hausner, Gideon. Justice in Jerusalem. London: Thomas Nelson and Sons, Ltd., 1966.
- Hilberg, Raul. The Destruction of the European Jews. Chicago: Quadrangle Books, 1961.

- _____. Destruction of the European Jews. Revised and Definitive Edition. 3 vols. New York: Holmes & Meier, 1985.
- Höss, Rudolf. Commandant of Auschwitz: The Autobiography of Rudolf Hoess. Translated by Constantine Fitz-Gibbon. London: Pan Books Ltd., 1974.
- Katz, Shmeul. Days of Fire. Garden City, New York: Doubleday & Company, Inc., 1968.
- Levy, Richard H. "The Bombing of Auschwitz Revisited: A Critical Analysis." In FDR and the Holocaust, edited by Verne W. Newton. New York: St. Martin's Press, 1996.
- Liddell Hart, B. H. History of the Second World War. New York: Putnam, 1973.
- Linenthal, Edward T. Preserving Memory: The Struggle to Create America's Holocaust Museum. New York: Viking, 1995.
- Lusar, Rudolf. Die deutschen Waffen and Geheimwaffen des 2. Weltkrieges und ihre Weiterentwicklung. München: J.F. Lehmanns Verlag, 1971.
- Marrus, Michael R. The Holocaust in History. New York: Meridian, 1987.
- _____. "Bystanders to the Holocaust (Review of Monty Penkower's The Jews Were Expendable: Free World Diplomacy and the Holocaust and David Wyman's Abandonment of the Jews: America and the Holocaust, 1941-1945)." In FDR and the Holocaust, edited by Verne W. Newton. New York: St. Martin's Press, 1996.
- Middlebrook, Martin and Everitt, Chris. The Bomber Command Diaries: An Operational Reference Book, 1939-1945. New York: Viking, 1985.
- Mierzejewski, Alfred C. The Collapse of the German War Economy, 1944-1945: Allied Air Power and the German National Railway. Chapel Hill, NC: The University of North Carolina Press, 1988.
- Morse, Arthur D. While Six Million Died: A Chronicle of American Apathy. New York: Random House, 1968.
- Newton, Verne W., ed. FDR and the Holocaust. New York: St. Martin's Press, 1996.
- Overy, R. J. The Air War 1939-1945. New York: Stein and Day, 1981.

- Penkower, Monty Noam. The Jews were Expendable: Free World Democracy and the Holocaust. Chicago: University of Illinois Press, 1983.
- Sharp, C. Martin and Bowyer, Michael J. F. Mosquito. London: Faber and Faber Limited, 1967.
- Steiner, George. Language and Silence. New York: Atheneum, 1967.
- Swanborough, Gordon, and Bowers, Peter M. United States Military Aircraft since 1909. Washington, DC: Smithsonian Institution Press, 1989.
- Wagner, Ray. American Combat Planes. 3rd ed. Garden City, NY: Doubleday & Company, Inc., 1982.
- Wasserstein, Bernard. Britain and the Jews of Europe, 1939-1945. New York: Oxford University Press, 1979.
- Andrew W. Waters, All the U. S. Air Force Airplanes, 1907-1983. New York: Hippocrene Books, 1983.
- Wyman, David S. The Abandonment of the Jews: America and the Holocaust, 1941-1945. New York: Pantheon Books, 1984.
- Wyman, David, ed. America and the Holocaust. 13 vols. New York: Garland Publishing, Inc., 1990. Vol. 12: Bombing Auschwitz and the Auschwitz Escapees' Reports.
- Yahil, Leni. The Holocaust: The Fate of European Jewry, 1932-1945. Translated by Ina Friedman and Haya Galai. New York: Oxford University Press, 1990.

Articles

- Bloomfield, Sara J. "A Moral Compass to Keep Us on Course." The Washington Post, 24 March 1990, p. A19.
- Blum, Lawrence H. In "Letters From Readers." Commentary 66 (July 1978): 7.
- Brugioni, Dino A. "Auschwitz-Birkenau: Why the World War II Photo Interpreters Failed to Identify the Extermination Complex." Military Intelligence, Vol 9, No. 1 (January-March 1983): 50-55.

Dawidowicz, Lucy S. "Could the United States Have Rescued European Jews from Hitler." This World, Issue 12 (Fall 1985): 14-30.

Foregger, Richard, M.D. "The Bombing of Auschwitz." Aerospace Historian vol. 34, no. 2 (Summer, June 1987): 98-110.

_____. " 'The Western Allies and the Holocaust': Technical Analysis of the Methods to Bomb the Gas Chambers at Auschwitz." Holocaust and Genocide Studies, vol. 5, no. 4, (1990): 403-421.

_____. "Two Sketch Maps of the Auschwitz-Birkenau Extermination Camps," The Journal of Military History 59 (October 1995): 687-696.

Groban, Milton. In "Letters From Readers." Commentary 66 (July 1978): 10-11.

Hodges, Robert H. " 'The Bombing of Auschwitz': A Clarification." Aerospace Historian, vol 35, no. 2 (Summer, June 1988): 123-130.

Horovitz, David. "Why the Allies Didn't Bomb Auschwitz." World Press Review, March 1995.

Hubert, Bernard. "The Camps (Cont'd.)." The Washington Post, 21 April 1990, p. A23.

Kitchens, James H., III. "The Bombing of Auschwitz Re-examined." The Journal of Military History 58 (April 1994): 233-266.

_____. "Why We Didn't Bomb the Death Camps." The WashingtonPost, 7 April 1990, p. A17.

Loebel, Herbert. In "Letters From Readers." Commentary 66 (July 1978): 7-10.

Mintz, Morton. "Why Didn't We Bomb Auschwitz?" The Washington Post, 17 April 1983, D1-D2.

Moskow, Michael G. " 'The Bombing of Auschwitz': A Reply." Aerospace Historian, vol 35, no. 2 (Summer, June 1988): 127-130.

New York Times, 4 November 1984, p. C13.

_____. 24 December 1984, p. 11.

New York Times Book Reviews, 16 December 1984, pp. 1 and 16.

_____. 17 March 1985, p. 42.

Williams, Roger M. "An American Moral Tragedy: Why wasn't Auschwitz Bombed?" Commonweal 105 (24 November 1978): 746-751.

Wyman, David S. "Why Auschwitz Was Never Bombed." Commentary 65 (May 1978): 37-46.

_____. In "Letters From Readers." Commentary 66 (July 1978): 11-12.

_____. "The Camps (Cont'd)." The Washington Post, 21 April 1990, p. A23.