

THIS FILE IS MADE AVAILABLE THROUGH THE DECLASSIFICATION EFFORTS AND RESEARCH OF:

# THE BLACK VAULT

THE BLACK VAULT IS THE LARGEST ONLINE FREEDOM OF INFORMATION ACT / GOVERNMENT RECORD CLEARING HOUSE IN THE WORLD. THE RESEARCH EFFORTS HERE ARE RESPONSIBLE FOR THE DECLASSIFICATION OF THOUSANDS OF DOCUMENTS THROUGHOUT THE U.S. GOVERNMENT, AND ALL CAN BE DOWNLOADED BY VISITING:

[HTTP://WWW.BLACKVAULT.COM](http://www.blackvault.com)

YOU ARE ENCOURAGED TO FORWARD THIS DOCUMENT TO YOUR FRIENDS, BUT PLEASE KEEP THIS IDENTIFYING IMAGE AT THE TOP OF THE .PDF SO OTHERS CAN DOWNLOAD MORE!

# PROJECT RAND

USAF PROJECT RR 1

## UTILITY OF A SATELLITE VEHICLE FOR RECONNAISSANCE

J. E. Lipp, R. M. Salter, Jr., R. S. Wehner  
and  
R. R. Carhart  
C. R. Culp  
S. L. Gendler  
W. J. Howard  
J. S. Thompson

April, 1951

R-217

**DISTRIBUTION STATEMENT A**

Approved for public release  
Distribution Unlimited

The **RAID** Corporation

19960409 163

# DISCLAIMER NOTICE

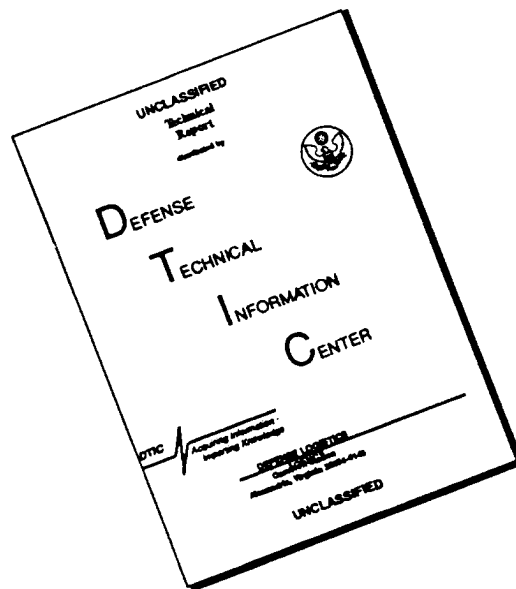

THIS DOCUMENT IS BEST QUALITY AVAILABLE. THE COPY FURNISHED TO DTIC CONTAINED A SIGNIFICANT NUMBER OF PAGES WHICH DO NOT REPRODUCE LEGIBLY.

**19960409 163**

**DONOT HAVE AND CANNOT GET PAGES *Viii*,**

**X, 2 AND 4 PER LINDA STANDLEY (310) 393-0411**

**AT RAND CORPORATION**

**MAY 16, 1996**

## CONTENTS

SUMMARY . . . . .	ix
SYMBOLS . . . . .	xi
INTRODUCTION . . . . .	1
I. SATELLITE ORBITS AND GROUND COVERAGE . . . . .	3
Orbits Generally . . . . .	3
Review of Orbital Features . . . . .	4
Orbital Regression and Resultant Periods . . . . .	4
Altitude, Velocity, and Duration . . . . .	6
Effect of Orbital Altitude on Ground Coverage and Related Problems . . . . .	7
Summary . . . . .	11
II. RECONNAISSANCE BY TELEVISION . . . . .	12
Reconnaissance Requirements . . . . .	13
Optical System . . . . .	17
The Television Camera . . . . .	18
Optical Techniques for Improving the Resolvable Surface Dimension . . . . .	21
Transmission of the Television Pictures . . . . .	28
Reception and Presentation of the Television Signal . . . . .	37
Summary . . . . .	39
III. ORBITAL ATTITUDE MEASUREMENT AND CONTROL . . . . .	40
Preorbital Ascent . . . . .	40
Orbital Attitude Requirements . . . . .	41
Flywheel System . . . . .	42
Gyro System . . . . .	43
Supplementary Orbital Attitude Controls . . . . .	44
Power and Weight Requirements . . . . .	44
Summary . . . . .	45
IV. AUXILIARY POWERPLANT . . . . .	46
The Vapor Engine System . . . . .	48
The Closed-cycle Gas Engine System . . . . .	57
Summary . . . . .	61
V. RELIABILITY OF THE SATELLITE . . . . .	63
Electronic Equipment . . . . .	63
Operating Requirements . . . . .	63
External Environment of the Electronic Equipment . . . . .	64
Statement of Reliability Requirements . . . . .	65
Present Versus Required Reliability . . . . .	66
Conclusions . . . . .	67
Reliability Research Program . . . . .	67
Summary . . . . .	69



DEPARTMENT OF THE AIR FORCE  
WASHINGTON DC 20330-1000



OFFICE OF THE SECRETARY

14 November 1995

MEMORANDUM FOR SAF/SXP (Col Cox)

FROM: SAF/PAS

SUBJECT: Declassification of Rand Documents

Subject Rand documents (R-262, Vol I and II; R-218; RM-1811; RM-2012; and R-217) have been reviewed by SAF/AAZD and were determined to be unclassified. The subject matter refers to programs which preceded the Corona program which is now being released through the National Archives. No sources or methods still requiring protection were noted and, from an Air Force standpoint, there is no objection to public release.

POC is Carol Rose, 697-3222.

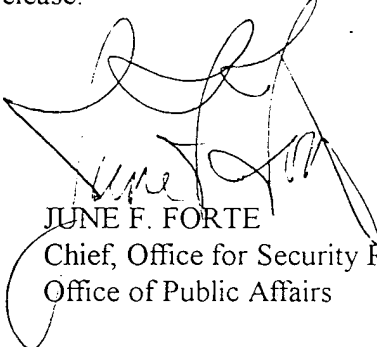

JUNE F. FORTE  
Chief, Office for Security Review  
Office of Public Affairs

Attachment:  
Rand Documents (SAF/PAS 95-1031)

→ Please ensure all classification markings are removed prior to release.

## FIGURES

1. Illustration of intersection of satellite's orbital plane and equatorial plane of earth . . . . .	4
2. Apparent rotation of satellite's orbital plane with respect to the day-night plane on the earth . . . . .	4
3. Satellite's orbital regression period for various orbital angles and altitudes . . . . .	5
4. Schematic illustration of nodal regression—satellite orbit . . . . .	5
5. Illustration of effect of satellite's orbital regression on viewing a point-target in daylight . . . . .	6
6. Multiple satellite orbits . . . . .	6
7. Satellite velocity and orbiting frequency vs altitude . . . . .	7
8. Duration time and total number of satellite revolutions vs altitude initially . . . . .	7
9. Satellite orbit showing flight-path traces on earth . . . . .	8
10. Horizon angle, $\Theta$ , as a function of altitude . . . . .	9
11. Asiatic observation at two radio ranges . . . . .	10
12. Surface albedo and scene contrast of clouds against various background surfaces . . . . .	14
13. Contrast vs relative albedos of various ground-cover materials . . . . .	15
14. Schematic illustration of optical-scanning system . . . . .	19
15. Print of high-resolution photograph of master mosaic of Los Angeles harbor area . . . . .	22
16. Same area of master mosaic as in Fig. 15, viewed by Image Orthicon television camera . . . . .	23
17. Reduced area of master mosaic, viewed by Image Orthicon television camera . . . . .	24
18. Further reduced area of master mosaic, viewed by Image Orthicon television camera . . . . .	25
19. Photograph of KNBH studio of NBC, with master mosaic of Los Angeles harbor on easel . . . . .	27
20. Photograph of monitoring control room of KNBH-NBC television station, showing scopes and photographic camera set up to record scenes . . . . .	27
21. Block diagram of TV transmission and antenna-tracking systems . . . . .	29
22. Maximum line-of-sight radio range as a function of altitude and minimum angular elevation above the horizon . . . . .	30
23. Schematic diagram of satellite-tracking transmission angles . . . . .	32
24. Schematic illustration of satellite's search-and-signal transmission system . . . . .	33

50. Total atmospheric attenuation as a function of wavelength (350-mi-orbital altitude, 1 mm/hr rainfall) . . . . .	109
51. Relation between object and image brightness . . . . .	111
52. Possible processes for obtaining satellite electrical supply . . . . .	121
53. Total heat that can be dissipated by radiation from skin of 1000-lb-payload satellite vs temperature of skin for two cases . . . . .	124
54. Insulation heat intake as a function of collection area and skin temperature . . . . .	127

### TABLES

1. Minimum resolvable surface dimension ( $\delta$ ) by day as a function of contrast and TV lines per inch for a given optical system . . . . .	17
2. Estimated power and weight requirements for the 1000-lb-payload reconnaissance satellite . . . . .	46
3. Some pertinent characteristics of Ce <sup>144</sup> , Ru <sup>106</sup> , Yt <sup>91</sup> , and Sr <sup>89</sup> . . . . .	51
4. Estimated weight of 500-watt vapor-cycle satellite auxiliary powerplant . . . . .	56
5. Estimated weight of 500-watt gas-cycle satellite auxiliary powerplant . . . . .	61
6. Weight breakdown for a 1000-lb-payload, 350-mi-orbital-altitude, hydrazine-oxygen satellite vehicle . . . . .	79
7. Albedos of terrestrial surface . . . . .	95
8. The brightness of stratocumulus clouds . . . . .	95
9. Contrast of clouds against various terrestrial backgrounds . . . . .	96
10. Minimum scene contrast for limiting resolution (Image Orthicons) . . . . .	96
11. Effective resolution as a function of scene contrast . . . . .	97
12. Smallest resolvable surface dimensions by day . . . . .	102
13. Smallest resolvable surface dimensions by night . . . . .	105
14. Quantum efficiency of various picture pickup devices . . . . .	105
15. Estimated weight, space, and power requirements of transmission system . . . . .	108
16. Total atmospheric attenuation as function of wavelength . . . . .	108



## SUMMARY

Utility of an earth-circling space vehicle as a reconnaissance device is considered here in detail. A satellite (initially placed on its orbit by rocket power) which televises ground scenes and weather information to surface receiving stations is investigated. Particular attention is given to the television, communication, and electrical-power-supply problems, since these are the major determining factors in payload utility of a reconnaissance satellite. Some important corollary aspects, namely attitude control and equipment reliability, are also discussed.

In order to round out the study, performance and weight estimates of the rocket vehicle required to carry a television payload are included.

The general conclusion of the report is that television satellites are feasible and that they would be useful if built and operated. Various essential lines of research in television, auxiliary power, and reliability are indicated.

Two other publications, one on weather reconnaissance<sup>(1)</sup> and the other on political and psychological aspects,<sup>(2)</sup> have been prepared and are being distributed concurrently.

---

For references, see page 135.

## SYMBOLS

- $a$  = diameter of the effective aperture of the camera, in.
- $B$  = scene brightness, ft-L
- $C$  = scene contrast, percent
- $C_D$  = drag coefficient
- $d$  = satellite's antenna (transmitting) dish size, ft
- $D$  = width of viewed surface area, mi; ground station's antenna (receiving) dish size, ft
- $E$  = power supplied to transmitter, watts; incident illumination, ft-c
- $f$  = f number of the optical system, or  $(F/a)$  ratio of focal length to effective aperture
- $F$  = focal length of TV camera, in.
- $g$  = acceleration of gravity = 32.2 ft/sec<sup>2</sup>
- $h$  = altitude, mi
- $I$  = information content
- $I_j$  = moment of inertia of unit, I<sup>4</sup>
- $k$  = Boltzmann constant, joules/°K; threshold signal-to-noise ratio
- $L$  = angle of obliquity between the orbital plane and the earth's equator, degrees
- $M$  = Mach number
- $M$  = control momentum applied to the vehicle
- $n$  = resolution of pickup tube, TV lines/in.
- $n'$  = resolution of pickup tube, TV lines/frame
- $n_0$  = over-all system resolution, TV lines/frame
- $N$  = frame frequency/sec
- $N_B$  = total number of satellite revolutions about the earth
- $p$  = probability of successful operation
- $P$  = transmitted power, watts
- $P$  = angular momentum of vehicle with respect to an inertial reference system
- $P_r$  = orbital regression period relative to the sunny side of earth, days
- $P_r$  = received power, watts
- $P_s$  = orbital regression period relative to celestial space, days
- $q$  = probability of failure
- $r$  = distance from the satellite to the center of the earth, mi
- $R$  = transmission range, meters (or mi)
- $R_E$  = radius of earth = 4000 mi
- $S/N$  = high-light signal-to-noise ratio
- $t$  = exposure time, sec
- $T$  = satellite duration time, days
- $V$  = velocity, ft/sec

---

## INTRODUCTION

The basic feasibility of satellites from the point of view of rocket performance was considered in a previous group of RAND reports, Refs. 3 through 14. That investigation pointed to several important conclusions. First, the engineering of a rocket vehicle of adequate performance for use as a satellite would require but minor development beyond the then-existing technology. Secondly, the payload would have to be small (not more than 2000 lb) to keep the gross weight within reason; hence destructive payloads are not likely to be economically worth while for many years to come. Thirdly, returning the vehicle to earth intact would be difficult and should not be attempted in the early versions.

The above factors indicated that the payload would be restricted to instrumentation and communication equipment and prompted the RDB (Technical Evaluation Group) and the Air Force to request that further attention be given to the question of utility. RAND's effort since 1947 on the satellite study has been closely tied to the payload—its description and military usefulness. Most attention has been directed toward reconnaissance, since that is a field in which a satellite may very well show advantages over other types of vehicles.

It now appears fortunate that reconnaissance was selected for the first payload investigation. As will be seen later in the report, pioneer reconnaissance (general location and determination of appropriate targets) and weather reconnaissance are suitable with the resolving power presently available to a satellite television system. These two classes of reconnaissance have also been growing in importance to the Air Force because of the vastness of Russia and the difficulty of gaining information by conventional means.

To explore further the possibility of reconnaissance by means of a satellite, it is necessary to investigate the various constraints imposed in conducting such an observation from a remote, unattended vehicle.

The first step in such an analysis logically considers the movement of the satellite as a vehicle with respect to the targets to be viewed. Consideration must be given to the degrees of freedom at our disposal in the type and position of orbits and to the frequency of the satellite within the orbit. This approach, from a macroscopic standpoint, gives rise to information on how often and under what conditions the satellite can be placed over a given target. This is discussed in Section I, "Satellite Orbits and Ground Coverage."

Naturally following this step is the microscopic inquiry into the feasibility of viewing a target from the satellite. Television has been selected as the only practical way known at present for transmitting back to earth that which can be seen from the vehicle. Thus an evaluation of television-camera-equipment capabilities, along with a discussion of associated problems of transmission of the pictures, is presented in Section II, "Reconnaissance by Television."

---

## I. SATELLITE ORBITS AND GROUND COVERAGE

This section presents a general discussion of the pertinent facts about orbits which are essential to the utility of a satellite as a reconnaissance vehicle and of the problems concerning the establishment of a rocket-vehicle satellite on an approximately circular or oblique orbit relative to the earth. Since the primary utility aspect considered is reconnaissance, the effect of orbits on scanning (i.e., viewing) angles, as well as some discussion of the limitations imposed by optical and radio transmission requirements, are included.

### ORBITS GENERALLY

A satellite is defined as an attendant body revolving about a larger one; a moon and a man-made object revolving about the earth are thus satellites. The earth itself is a satellite of the sun. The shape of a satellite orbit, which can be either circular or elliptical, is dependent principally on the initial conditions of velocity, position, and direction of motion.

A circular orbit is of course the most desirable for an artificial satellite. Any marked deviations or eccentricity would cause some portion of the flight path to pass through more dense atmosphere and thus decrease the endurance of the satellite (for the likely range of orbital altitudes).

In order to remain on an orbit, the velocity of a satellite must be such that its centrifugal force is sufficient to overcome the earth's gravitational forces upon the satellite at the orbital altitude. Initial trajectory control is required to be such that the velocity is at least that necessary for a circular orbit\* at the design altitude, and the path angle is within  $\frac{1}{2}^\circ$ .<sup>(1)</sup> These limits are attainable with present control equipment.

RAND's previous studies were devoted primarily to equatorial orbits, which are still of prime interest for preliminary, experimental satellite flights. However, it is obvious that a reconnaissance satellite must be placed on an oblique orbit to view targets of military interest most efficiently.

---

\* Velocities less than that required for a circular orbit obviously prevent the vehicle from establishing the prescribed orbit; hence the satellite will either fall to earth or assume an elliptical orbit which will cause marked altitude variations. Velocities greater than required yield less disastrous, but also undesirable, elliptical paths.

† In this report an orbit will be designated by the designation of an angle between it and the equator. An alternative but equivalent description is the maximum latitude to which the orbit is tangent. Thus a  $0^\circ$  orbit is equatorial, a  $90^\circ$  orbit is polar, and a  $56^\circ$  orbit is  $56^\circ$  oblique to the equator and tangent at  $56^\circ$  latitude.

perturbation, namely, a significant regression of the nodes\* when the satellite orbit is oblique. This regression is similar to the precession of a gyroscope caused by externally applied torques.

Further, the regression period† of the satellite orbit will vary, depending on the orbital altitude and obliquity. After the method of Ref. 14, the orbital regression periods relative to the sunny side of the earth and to celestial space are plotted as functions of altitude and orbital angle in Fig. 3. For useful reconnaissance orbits,  $45^\circ$  to  $60^\circ$  obliquity and 350 to 500 mi altitude, the change in period relative to the earth is not great.

For illustrative purposes only, a  $56^\circ$  oblique orbit, approximately the latitude of Moscow, will be studied for most of the balance of this discussion. Figure 4 depicts the nodal regression for a vehicle on such a path. It may be seen in this illustration that the position of the orbit relative to the sunny side of the earth changes not with the earth's seasons, but much more rapidly; for this particular orbit, the period relative to the earth is 70 days rather than a year.

Under these conditions, the satellite can see a given target in the daytime only during alternate 35-day intervals regardless of whether the satellite circles the earth once a day or a thousand times; Fig. 5 amplifies this point. Thus a single satellite cannot

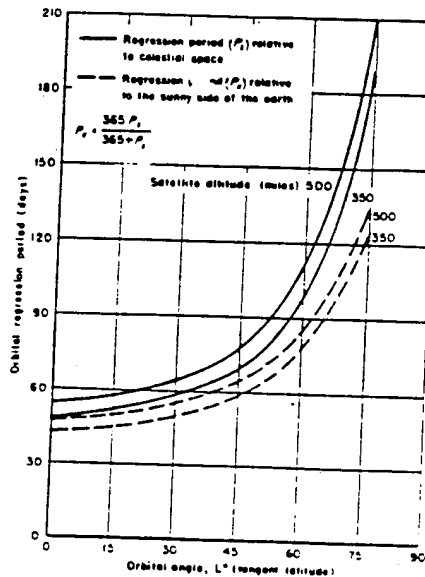

Fig. 3—Satellite's orbital regression period for various orbital angles and altitudes

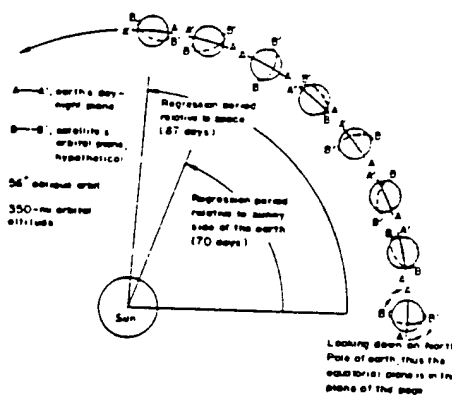

Fig. 4—Schematic illustration of nodal regression—satellite orbit

\* Regression of the nodes may be visualized as a westerly rotation of the line of intersection (nodal line) between the satellite's orbital plane and the earth's equatorial plane (see Figs. 1, 4, and 5).

† Regression period, as used here, is the time required for the intersection line (see footnote above) to make one complete revolution relative either to the sunny side of the earth or to celestial space, as applicable (see Fig. 4).

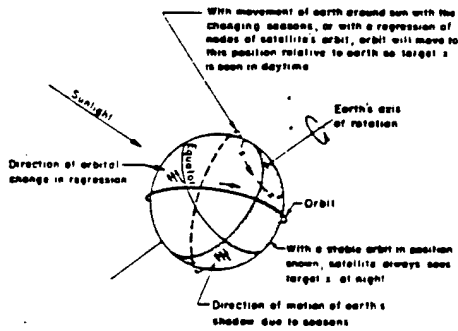

Fig. 5—Illustration of effect of satellite's orbital regression on viewing a point-target in daylight

give a continuous record of daytime viewing of a particular target, but only during alternate 35-day periods. If continuous chronological daytime coverage is desired for longer periods, a minimum of two vehicles would be required. Further, if contrast requirements exclude twilight intervals, then three satellites operating on 8-hr shifts, with paths as shown in Fig. 6, are necessary.

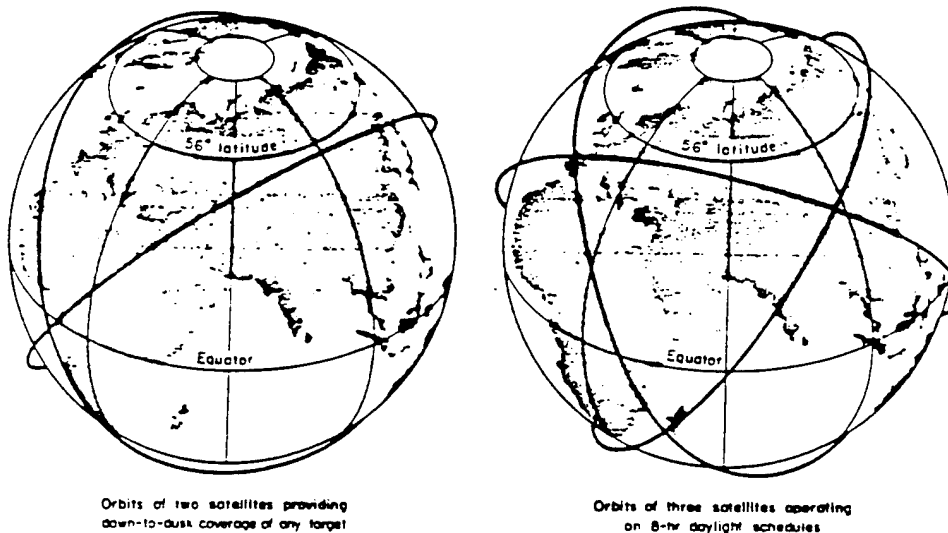

Fig. 6—Multiple satellite orbits

#### ALTITUDE, VELOCITY, AND DURATION

So far, discussion has been centered on the path of the satellite in its orbit. Its speed and altitude will now be considered. Figure 7 gives a plot of the required satellite velocity as a function of altitude above the earth for a nearly circular orbit. Since this velocity is independent of the earth's rotation, a satellite launched eastward gains by the component of the earth's peripheral speed in that direction. Figure 7 also shows the number of satellite revolutions per day as affected by orbital altitude.

The duration of an orbiting vehicle depends on the amount of atmosphere tending to slow it down. This in turn means that the higher the altitude, the longer the satellite

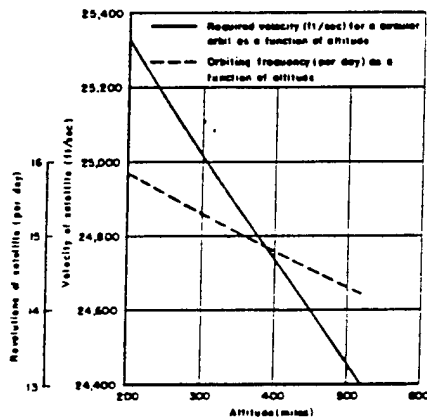

Fig. 7—Satellite velocity and orbiting frequency vs altitude

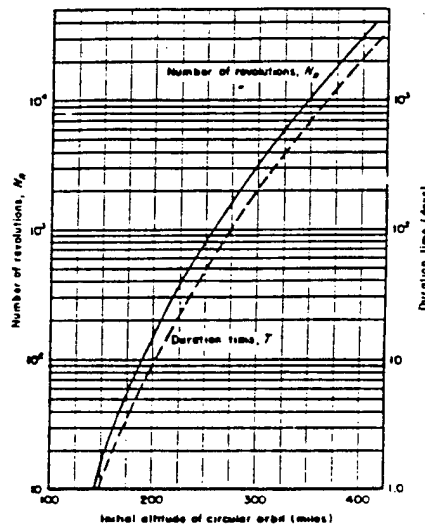

Fig. 8—Duration time and total number of satellite revolutions vs altitude initially

can stay up. Figure 8, taken from Ref. 3, gives anticipated duration as a function of altitude. At a 100-mi altitude the vehicle will be pulled to earth in less than one revolution because of the atmospheric drag. At 350 mi the duration is about 2 years. At 500 mi the satellite will stay up around 50 years; at 600 mi, several centuries. From this standpoint alone, it is desirable to use as high an altitude as possible. Also, the range of line-of-sight\* radio transmission increases with altitude. Counterbalancing these factors is the greater size of the satellite required to put a given payload on an orbit at higher altitudes (e.g., 10 to 20 per cent higher gross weight is required to increase altitude from 350 to 500 mi; see Fig. 40, page 77). Another deterrent factor is the increased size and weight of camera equipment necessary to scan the earth from higher altitudes, which requires higher resolving power for an equivalent picture. Therefore, the desirable altitude will represent a compromise between these opposing features but will probably lie between 350 and 500 mi. For purposes of consistency, a 350-mi altitude will be used in the remainder of this report, except where altitude is considered as a variable.

#### EFFECT OF ORBITAL ALTITUDE ON GROUND COVERAGE AND RELATED PROBLEMS

At orbital altitudes of 350 to 500 mi, the satellite circles the earth fifteen to fourteen times a day (see Fig. 7). The satellite tracks cross the equator at intervals of  $24^\circ$  to

\* Only line-of-sight transmission can be used because high-frequency waves are necessary for television equipment. Also, long radio wavelengths will be adversely affected by the ionosphere; for instance, reflection by the Heaviside layer will prevent such wavelengths from reaching the earth rather than to increase their range.

25° longitude or, roughly, there are 1700 mi (measured east-west at the equator) between tracks for the 350-mi altitude.

At 56° latitude, for example, this interval is about 800 mi; near the tangent latitude the tracks recross each other several times. Figure 9 indicates the tracks for a satellite at an orbital altitude of 350 mi and at an orbital angle of 56°. Also shown is the average daytime coverage during the daylight "season" with a 400-mi optical scan to either side of the satellite (800-mi optical-scanning band); the light-green area shows targets covered once a day; medium green, those covered twice; and dark green, those covered three or more times. White areas (below the tangent latitude) are those viewed less than once a day; as indicated in the figure, for the assumed satellite orbit, coverage in any one day is not complete below 30° N. latitude.

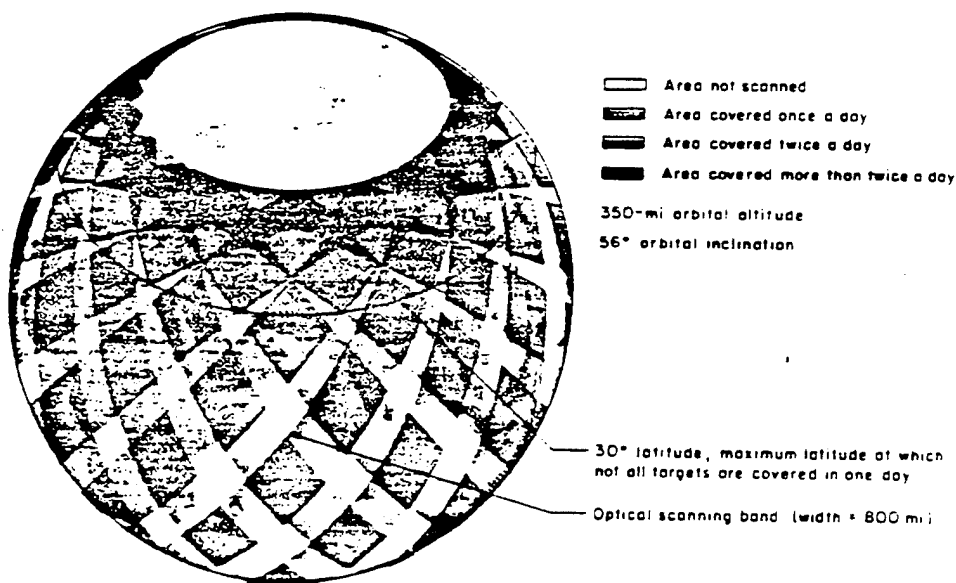

Fig. 9—Satellite orbit showing flight-path traces on earth

The 800-mi optical-scanning band at 350 mi altitude represents approximately a 94° included scanning angle, i.e., a 47° scan to either side of the vertical. The included angle of the horizon is 135°, but the value of pictures taken beyond 45° on either side of vertical is questionable. This point is shown schematically in Fig. 10, which also gives a plot of horizon angle as a function of altitude. A discussion of the effects of scanning angle, as well as those of the orbital inclination, upon the minimum resolvable surface dimension is presented in Appendix I.

Proper initial selection of the orbital altitude would enable the satellite to make an integral number of revolutions for one revolution of the earth relative to the orbital plane (not necessarily per 24-hr day, since the orbital plane regresses\*). Integral num-

\* The period for a 350-mi altitude, 56° orbit is 24.31 hr, which is termed a day throughout the remainder of this discussion.



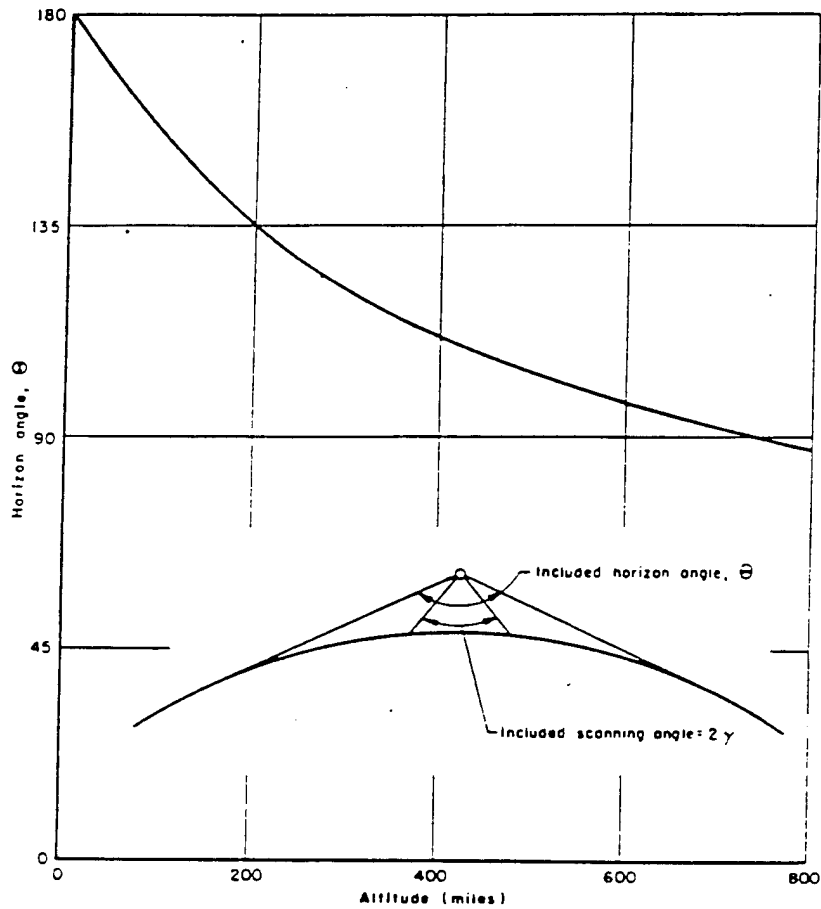

Fig. 10—Horizon angle,  $\Theta$ , as a function of altitude

bers of satellite revolutions every other (24.3-hr) day, every third day, etc., are also possible. Such orbital conditions, however, cannot be made accurately enough with present control equipment to afford the same trace on the earth's surface day after day. Thus a drift can be expected so that the satellite will come within a few miles of its track on the previous day (or the previous alternate day, etc.). The significant fact is that by adjusting an orbital period so that it is nearly integral on alternate days, one can obtain, the following day, a picture in the center of the camera scan of a target which was on the periphery the day before (see Fig. 9), except, of course, near the tangent latitude, in which region still greater amounts of overlap are obtained.

As mentioned earlier, one factor indicating the desirability of a 500-mi altitude is the need to receive the satellite's television broadcasts by stations sited either in friendly territories or on ships. Figure 11 shows the area of reconnaissance interest which would be covered by transmission ranges of 1396 and 1743 mi with 5 stations and 2000 mi

with 4 stations (see Fig. 22, page 30, for range as a function of altitude and elevation angle). Transmission must be "line-of-sight" because of the required radiation frequencies. It is estimated that the maximum range for acceptable transmission\* from a 350-mi altitude is about 1400 mi. At this range, 5 stations would be required to pick up Asiatic observations, but about 15 per cent of the USSR, a significant portion near 105°E. longitude, would be left out. Increasing the satellite's altitude to 500 mi affords (on the same basis) a range of approximately 1750 mi. With this range and the same 5 stations, the unobserved area is reduced to a small amount.

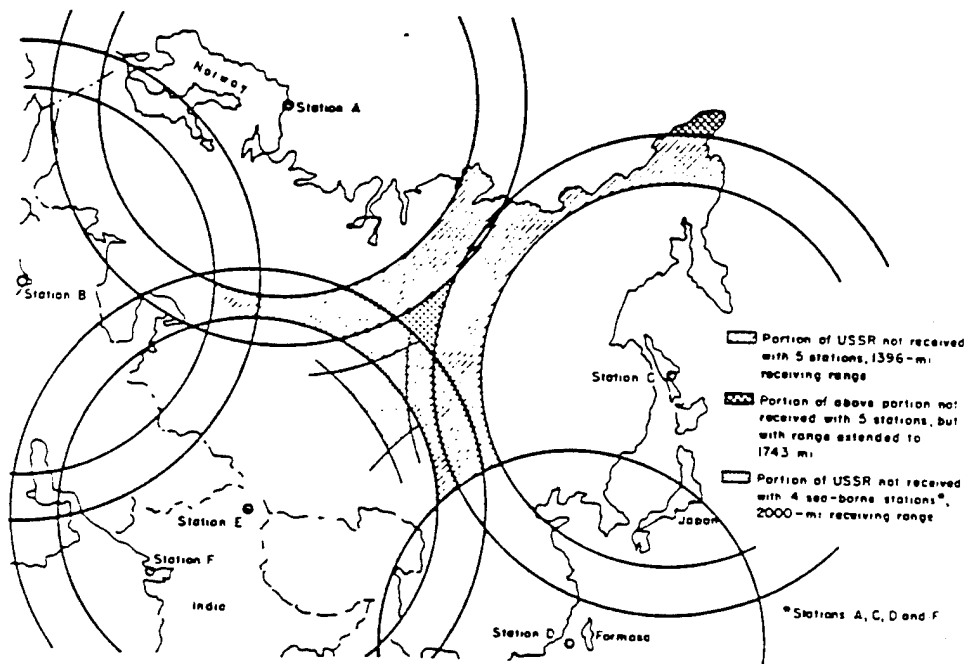

Fig. 11—Asiatic observation at two radio ranges

With a 2000-mi range (not shown), the unobserved area would be eliminated. However, by accepting a small unobserved area near 95°E. longitude, 4 sea-borne stations could be employed. At this latter range, the orbital altitude required for equivalent clarity of the transmission exceeds 600 mi (see Fig. 22, page 30); it may be possible to attain a 2000-mi range from a 500-mi altitude, although some uncertainty and signal distortion would occur in the 100- to 250-mi extremity.

The possibility of eliminating so-called unobservable areas by using delayed broadcasting becomes apparent. It is well to note, however, that the number of frames to be filed would cause the transmitting device to be so bulky and complex that this method does not appear to warrant further investigation at the present time.

\* It is assumed that a minimum elevation angle (above the horizon) of 5° be employed for completely acceptable signal reception.<sup>(10)</sup>

---

The effect of different altitudes upon target viewing, as well as upon television camera resolution and contrast, is discussed further in the next section.

#### **SUMMARY**

To summarize briefly, the orbiting characteristics are critically dependent on the altitude; a substantially circular orbit is most desirable. Although equatorial orbits are desirable for test purposes, oblique orbits are necessary for meaningful reconnaissance. For example, a 350-mi altitude,  $56^\circ$  orbit, in combination with an 87-day regression period of the orbital plane relative to celestial space and to the seasonal motion of the earth around the sun, will afford daylight views of a specific target during alternate approximately 35-day intervals (one-half the 70-day regression period relative to the earth). Complete target-system coverage, from the eastern to western limits of Russian-controlled territory, will reduce the unproductive interval by about one-half.

---

## II. RECONNAISSANCE BY TELEVISION

In the first section, the macroscopic aspects of satellite reconnaissance have been discussed, namely, the placement of the vehicle in appropriate orbits for bringing targets of military significance under scrutiny. The means for viewing and transmitting these scenes to ground stations will now be weighed. At the present time, it is felt desirable to consider only remote transmission of picture information by high-frequency radio waves. Other possible alternatives, such as using a conventional aerial photographic camera and returning the satellite to earth on command, appear to involve difficulties that would make early versions of the satellite impractical.

Two systems, television and photographic facsimile transmission, are available for consideration for photographing and sending on reconnaissance data. The latter system uses camera film to record temporarily scene information; this film is then scanned electronically and the impulses transmitted as in the standard "wirephoto" system. A re-usable film must be employed because, otherwise, roughly  $\frac{3}{4}$  ton of camera film would be required per month's operation. Since we know of no re-usable film (or other less bulky storage strip) under development, the photographic facsimile system will be ruled out for the present; future requirements, such as those for delayed picture transmission, may cause reconsideration of this system.

The use of television emerges, then, as of prime import in viewing and sending to ground stations reconnaissance information for recording and for evaluation. The ability of such a system to accommodate reconnaissance requisites will be considered in detail, both for viewing weather and for observing ground targets. Each of these latter types of reconnaissance has its own peculiar needs, which will be discussed first in this section.

The effect of reconnaissance requirements on camera equipment is considered next. It will be demonstrated that daytime viewing is possible, but nighttime light levels are too low for practical televising. The discussion of daytime viewing is then expanded to include specific numbers of the minimum resolvable ground dimensions as functions of scene contrast, frame speed, and the number of lines per inch resolution of the camera. A correlation between the ground area to be covered and the frame speed, and the need for an optical-scanning system, are determined. The above investigation is of a general nature and would apply to any "camera," whether it uses film, is a television tube, or is the human eye.

Logically following the above discussion, the television camera tubes are examined in relation to the foregoing optical parameters. The commercial Image Orthicon and the Vidicon tubes are shown to be within the realm of possibility for satellite viewing.

A discussion is then presented of the television camera system in context with the reconnaissance requirements and of the various combinations of characteristics that could be employed to produce an over-all optical-scanning system for use in both weather

---

and terrestrial reconnaissance. Also included are actual photographs of a simulated ground scene by a commercial Image Orthicon camera. It is shown that even by present commercial television standards, useful scene information can be obtained.

The transmission of the televised scenes, the necessary television mechanisms, the effects of signal wavelength, the position of the satellite relative to ground stations, and the possibility of enemy interception and jamming are included in the next subsection. Following this is an analysis of the reception and presentation of the televised signal as would be done by the ground monitoring stations.

Weight estimates and power requirements for the satellite television camera-transmitter system are then presented. For a more complete analysis of the television system's design considerations, see Appendix II.

## RECONNAISSANCE REQUIREMENTS

To obtain any useful information from altitudes of 350 to 500 mi appears at the outset to be an extremely difficult operation. It is the purpose here to examine the constraints imposed on the television system in conducting reconnaissance of a worthwhile nature. Two types of observation will be considered: weather and terrestrial.

### Weather Reconnaissance

Reference 1 offers a far more complete analysis of the requirements for weather reconnaissance than can be given here. However, in this report it is desirable to discuss briefly these requisites for the purpose of continuity. Information in Ref. 1 reveals that details of cloud structure as small as several hundred feet in dimension may possess meteorological significance. For weather observations, resolutions as poor as 500 to 1000 ft can be utilized, although a better minimum resolvable dimension would be 200 ft. This latter resolution is ample to determine a major portion of the characteristics necessary to predict weather. At this resolution, orientation and structure of clouds, direction of winds, and presence of fronts can be seen.

To explore deeply into the problem, the prevailing contrasts of weather scenes must be examined. For weather reconnaissance, the contrast is a function of the albedos\* of various types of clouds and of the background. An albedo of 0.8, commonly given for average cloud formations (see Fig. 49, page 94), is used with the albedos of the various surface backgrounds to determine the degree of contrast available. Figure 12 shows graphically that contrasts of 50 per cent or more are produced by virtually all ground-surface background conditions except that of fresh snow; also shown in Fig. 12 is a similar graph for smooth sea surfaces and various solar elevations.

An additional feature of weather reconnaissance is the need to encompass the entire area in question with a daily observational coverage.

At the risk of being premature in describing the television system, a few illustrative remarks will be made here. An optical-scanning system viewing a band on the earth's surface of 800 mi width and taking frames, or pictures, at the rate of ten per second

---

\* Albedo is the ratio of the amount of light reflected from a perfectly diffuse surface to the total light falling upon it.

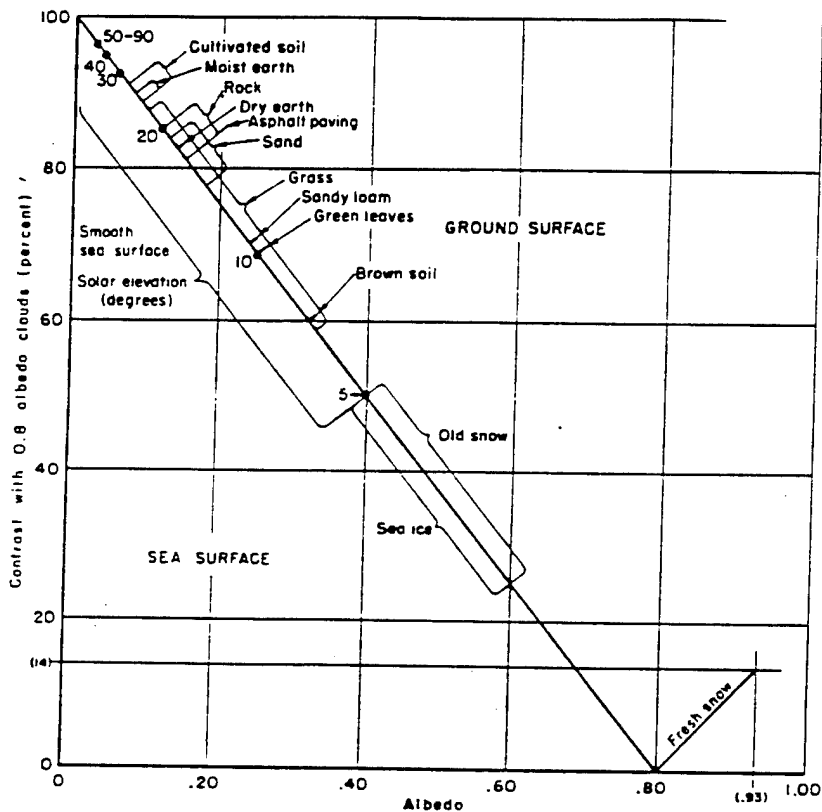

Fig. 12—Surface albedo and scene contrast of clouds against various background surfaces

will be assumed. A standard Image Orthicon television camera with appropriate optics at the 10 frame/sec speed and for the pertinent contrasts prevailing in weather scenes will resolve a dimension of 200 ft. Therefore the conclusion is that such a system could be completely adequate and useful for meteorological observational purposes.

#### Terrestrial Reconnaissance

The requirements for viewing targets—of military significance—on the ground are now considered. Taking the cue from the above discussion, it is apparent that a 200-ft resolution can be easily attained at prevailing weather contrast levels (which are nearly all at contrasts above 20 per cent) and that a complete daily area coverage can be expected with this system. However, that contrasts of less than 20 per cent do exist on military targets and that a 200-ft resolution will not be completely adequate will be discussed subsequently.

Figure 13 depicts contrasts that may be expected from various military targets against representative backgrounds. Year-round observation from the satellite will yield a number of pictures of a given target during the different seasons, possibly with informative

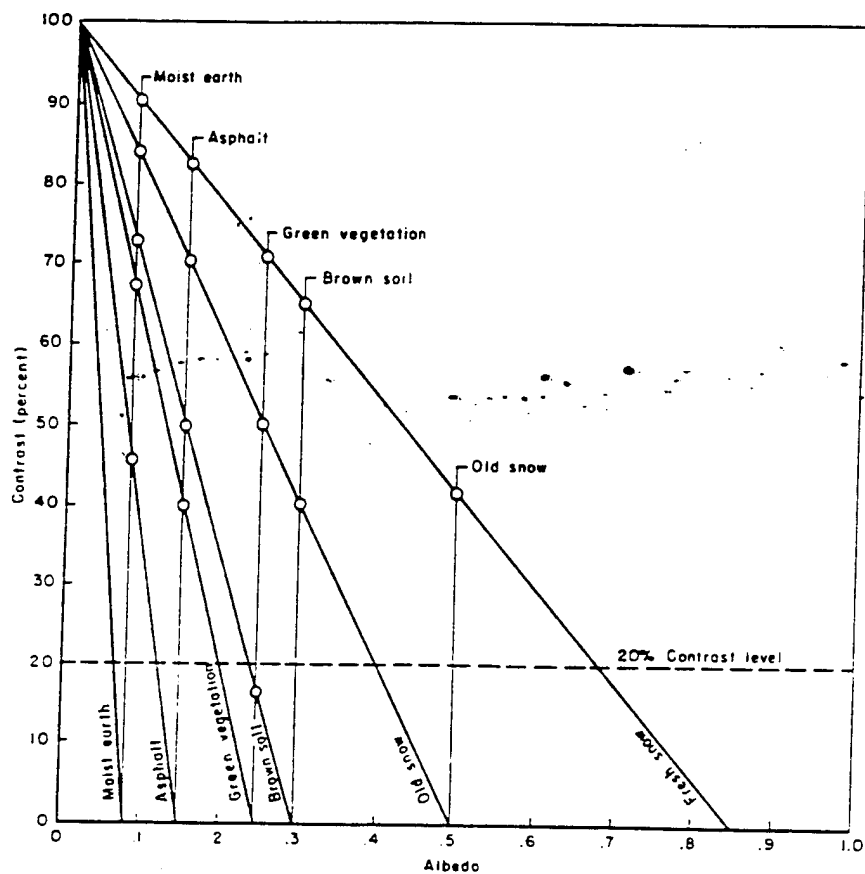

Fig. 13—Contrast vs relative albedos of various ground-cover materials

results. For example, an asphalt airstrip and its adjacent ground cover may have no albedo difference, hence no contrast, during the spring-to-fall period; during early winter, however, a thin layer of snow on the adjacent ground cover, but melted or removed from the airstrip, may result in contrasts as high as 85 per cent. Furthermore, continued observations throughout seasonal ground-cover variations will tend to reduce the effectiveness of camouflage. It is readily apparent that the conditions for taking such pictures are dependent on the number of clear days during the period the satellite passes over a specified military target. However, if a continuous chronological record is broadcast from the satellite for a year, it is reasonable to expect that each target will be seen at some time on a clear day.

The second criterion for terrestrial reconnaissance is, of course, the allowable minimum resolvable surface dimension. The ultimate choice of the figure for this dimension will remain with intelligence personnel skilled at interpreting information. The 200-ft resolution is probably adequate for ferreting out major airfields and for noting the presence of large highway, or railroad right-of-ways (even though lateral dimensions may be

---

considerably less than 200 ft). Large factory buildings will be seen, although their exact shape may be indeterminable. Square buildings of 200 ft on a side will tend to be confused with round fuel-storage tanks of similar size.

A 50-ft resolvable dimension will afford considerable improvement in detailed information. The structure of urban areas can be determined. Large aircraft can be identified, as can gun emplacements, revetments, etc.

Assessment of bomb damage will probably require even better resolving power (perhaps as low as 10 ft) and may well be beyond the scope of the satellite system.

From the above discussion, it is seen that the previously assumed camera and scanning system is, on the basis of minimum resolvable surface dimension, useful and adequate for pioneer terrestrial reconnaissance. However, such a system is inadequate for reconnaissance concerned with detailed target identification. The ways in which detailed reconnaissance can be achieved are discussed later in this section, but it can be stated briefly that either a fundamental improvement in the television camera tube or a reduction of the observable area on the ground—so that complete coverage is not made every day but every 10 days or so—must be made.

#### **Summary of Reconnaissance Requirements for the Television System**

It has been shown that minimum resolvable dimensions of 50 to 500 ft are acceptable, depending on the type of observations made. Thus the television camera must be capable of resolving dimensions on the ground—or near the ground for weather—of the same order of magnitude measured in feet as  $\frac{1}{10}$  to 1 times that of the optical range measured in miles. This resolving power,  $0.001^\circ$  to  $0.01^\circ$ , implies a small angle of view, as will be demonstrated later.

Optical scanning over a reasonably wide swath on the earth's surface will require (in conjunction with the small field of view) a large number of frames in a given time interval—of the order of 10 to 30 frames/sec.

Contrast levels of 20 per cent or higher will normally be needed.

#### **Nighttime and Color Television**

So far, discussion has been predicated on the conditions that would prevail in taking black-and-white pictures in the daytime. For black-and-white shots at night, the same scene contrasts would be expected, *but the over-all scene brightness would be considerably reduced.*

The use of television for transmitting scenes viewed by a satellite at night, while physically possible (see Appendix II), is considered impractical. A camera system sufficiently flexible to accommodate both daytime and nighttime viewing not only would be complex, but also would require an  $f/0.6$  optical system, which in turn would require a 30-in. aperture for a 20-in. focal length (as compared with a 2-in. aperture for daytime viewing). The total size and weight of such a device as presently conceived would be prohibitive.

Although color television has lower resolution than black-and-white video, the use of color television might result in more effective photo interpretation. For example, a



black airstrip surrounded by green grass can readily be identified in color even though its black-and-white contrast may be zero. It is doubtful, however, that color television could counteract camouflage because the TV camera does not see more of the infrared spectrum than does the human eye. Size, weight, and complexity of such a system do not warrant its further investigation at this time.

Hence the remainder of the section will be devoted to black-and-white television, with viewing done only in daylight.

## OPTICAL SYSTEM

### Resolving Power and Contrast

Resolvable detail in photographs made by satellite television (or any other type of camera) is dependent on brightness, scene contrast, exposure time, and geometrical factors. It is also a function of the inherent resolution of the camera itself. A television camera is characterized by the number of television lines per inch (equal to roughly twice the number of optical lines per inch) and this parameter is an index of the tube's resolution.\*

In Table 12, on page 102, may be found an enumeration of the minimum surface dimensions,  $\delta$ , resolvable by day for various contrasts, TV lines per inch camera resolution, and frame frequencies and for the various required optical parameters of focal length and aperture size. Along with  $\delta$ , the relative power,  $P$ , required for picture transmission is also listed.

A digest of Table 12 is given in Table 1, below, which shows what can be accom-

**Table 1**  
**MINIMUM RESOLVABLE SURFACE DIMENSION ( $\delta$ ) BY DAY AS A FUNCTION**  
**OF CONTRAST AND TV LINES PER INCH FOR A GIVEN**  
**OPTICAL SYSTEM**

(f/10 Lens, 2-In. Camera Aperture, 20-In. Focal Length Camera; 10 Frames/Sec Frequency)

Contrast (%)	Minimum Resolvable Surface Dimension, $\delta$ , (ft)		
	Camera Resolution		
	500 TV lines/in.	1000 TV line/in.	1500 TV lines/in.
$\geq 25$	370	185	125
20	370	185	165
15	370	295	295
10	660	660	660

plished with an f/10, 2-in. camera aperture, 20-in. focal length camera, operating at a frequency of 10 frames/sec.

\* Resolution by a photographic camera is commonly defined by the minimum spacing of lines that can just be discerned in a photograph by the camera. In television the index is based on the distance from one of the lines to the center of the intervening space between the lines (this distance

---

It is expected that the Image Orthicon camera tube (see page 20) will give resolutions of the order of 1000 TV lines/in., which means that with the above optical system, a 200-ft minimum resolvable surface dimension can be anticipated for contrasts as low as 20 per cent.

By changing the camera optics to restrict the field of view and by increasing frame frequency, it may be noted from Table 12, page 102, that considerable improvement in  $\delta$  can be wrought. Values as low as  $\delta = 40$  ft (at 25 per cent contrast) are obtained with the same TV tube resolution of 1000 TV lines/in.

### The Optical-scanning System

The  $f/10$ , 20-in. focal length optical system will view, in a single frame, a ground-projected square area of 17.5 mi on a side directly under the satellite. (Figure 15, page 22, shows an equivalent southwest sector of Los Angeles which would be taken by one frame.) A  $47^\circ$  viewing angle will cover a ground-surface width of 800 mi from an altitude of 350 mi. Because of the curvature and obliquity of the surface of the earth, as shown in Fig. 10, page 9, the ground area seen by the optical system at  $47^\circ$  (the angle measured from the vertical) is nearly doubled, the transverse ground dimension being about 35 mi. Consequently, 39 to 40 frames are needed to view the 800-mi band in one transverse sweep.

During this same time, the satellite is moving forward 17.5 mi at a speed of approximately 5 mi/sec, which allows about 3.5 sec/transverse sweep and, for 39 to 40 frames, checks generally with the previously assumed 10 frames/sec.

The motion of the optical scan must be such that the area under observation is "stopped" relative to the photocathode, which requires indexing between successive frames in the transverse sweep, and to the fore-and-aft motion to compensate for the satellite's forward motion.

Transverse and longitudinal camera positions relative to the satellite structure are shown in Fig. 14 as functions of time per frame. Also shown is a proposed scanning system. It may be possible to synthesize this complex motion by an appropriately designed, continuously rotating prism (not shown).

Satellite attitude control of yaw, pitch, and roll, relative to "stopping" the picture, is discussed in Section III. Further discussions of the scanning angle, of the orbital inclination, of the frame frequency, and of the resolvable surface dimensions are presented in Appendixes I and II.

### THE TELEVISION CAMERA

The task of televising a ground scene from a satellite differs from the ordinary video pickup problem in three principle ways: (1) as just indicated, a high-resolution, scanning optical system is required, (2) the equipment must operate over a relatively

---

being called one television "line"). Thus one optical line is equivalent, approximately, to two television lines. It should be noted that a single index of this type is inadequate to describe fully the quality of a camera, and it is assumed in this report that the television cameras have good characteristics with respect to sensitivity as a function of the various sizes of the objects viewed.

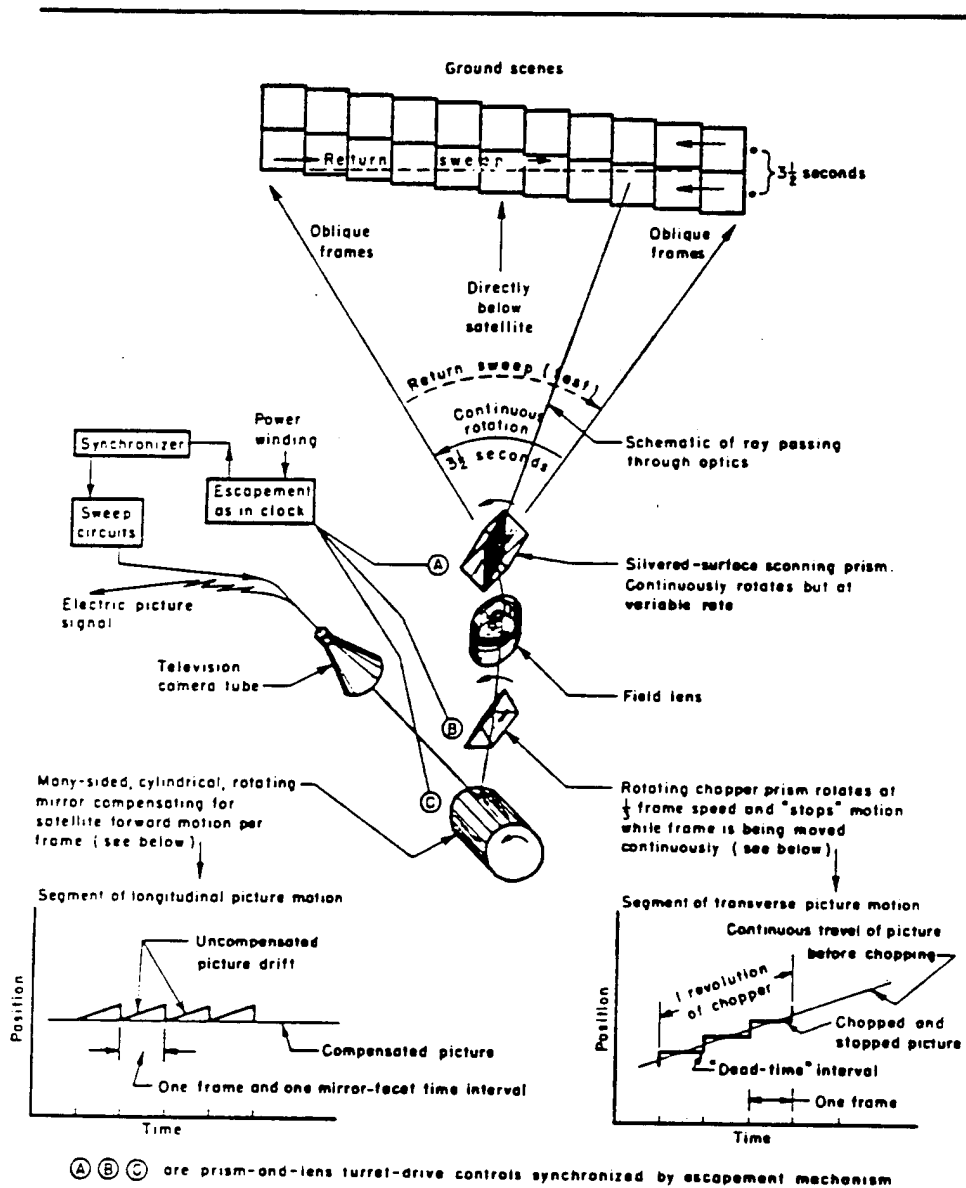

Fig. 14—Schematic illustration of optical-scanning system

long period of time from a remote, unattended station, and (3) each frame is a completely different picture. This latter subject is discussed further under "Reliability of the Satellite," Section V, page 63. It is probable that presently available television-tube resolutions are adequate for preliminary reconnaissance of either weather or terrain; however, it is anticipated that the normal trend in television research will yield higher resolutions by the time a satellite requires such a system.

---

### Limiting Resolution of Pickup Tubes

The basic elements of modern television camera tubes are (1) a photosensitive target, upon which the viewed scene is projected and reproduced as a pattern of static electric charges, and (2) an electron beam which scans the charge pattern on the target, reading and erasing it and transforming it into a time-varying electrical signal. The scanning beam is usually made to cover the target in a series of horizontal lines or in two interlaced series of lines, and the beam moves at such speed that the entire picture, or frame, is scanned in a small fraction of a second. Present commercial television practice employs 525 scanning lines/frames at a rate of 30 frames/sec, and the pickup-tube resolution is therefore limited to 525 TV lines/frame (or slightly more than 250 optical lines). A more fundamental limitation on the resolution of a pickup tube than the number of scanning lines is the finite size of the cross section of the scanning beam or the finite size of the elements composing the target, whichever is larger. It is of interest to note that the scanning-beam sizes in electron microscopes is an order of magnitude smaller ( $10^{-3}$  min spot size).

The resolution of the best available photoemissive pickup tubes (Image Orthicons) is limited by target structure. This tube uses a thin two-sided target, upon one side of which the charge pattern representing the scene televised is deposited by secondary emission. Photoelectrons from the primary cathode, or photocathode, of the tube focus upon the target and impinge upon it under conditions which result in a high secondary emission ratio; each incident photoelectron ejects several secondary electrons from the target face, the charge pattern on the target being correspondingly more intense than that on the photocathode. These secondary electrons are collected by a grid of very fine wire mounted close to the target on the photocathode side. The grid effectively breaks up the otherwise continuous target surface into a mosaic of elements of size corresponding to its mesh spacing. In commercial Image Orthicons, the grid contains slightly more than 500 mesh spacings/linear in., and the limiting resolution is therefore about 500 optical lines/in., or 1000 TV lines, of target surface. Experimental Image Orthicons have been made with finer grid meshes, corresponding to limiting resolutions better than 1500 TV lines/in.

Resolving power of present photoconductive pickup tubes (Vidicons) is limited by the cross-sectional size of the scanning beam. The photoconductive process is inherently more sensitive than photoemission and no preliminary amplification of the target charge pattern by secondary emission is required; no collecting grid is involved and the Vidicon target is essentially continuous. The smallest resolvable target element is therefore determined approximately by the half-power width of the scanning beam (at the target). In a recently developed Vidicon, this beamwidth is about 0.00125 inclusive, corresponding to a limiting tube resolution of about 1600 TV lines to an *inch*. However, this does not mean that the present Vidicons have a higher resolution than do Image Orthicons. On the contrary, the present target size of the Vidicon is considerably less than 1 in., and the number of TV lines to a *frame* is less than in the Image Orthicon. Major difficulty would be experienced in attempting to increase the Vidicon target sizes to about an inch (as in the Image Orthicon) because of the increasing electrical capacitance of

---

the target. Nevertheless, this does not preclude the possibility of using several Vidicons to replace one Image Orthicon, with the attendant reduction of reliability.

The possibility of a really significant improvement in the limiting resolution of an Image-Orthicon-type pickup tube is regarded as remote, because of the great difficulties inherent in constructing and mounting collecting screens composed of conductors much smaller than about one-thousandth of an inch in diameter. Significant improvement seems more likely in the case of photoconductive tubes, since much narrower scanning beams are theoretically possible by improvement of the optical design of the electron gun and of the focusing and scanning fields. But a limit will soon be reached at which further reduction in beam spot size results in no further improvement in resolution and at which resolution will be limited by the finite conductivity of the target. This follows from the fact that the thickness and conductivity of the target must be such as to allow for dissipation of the charge pattern by conduction through the target in a period not much greater than the frame time; if the conductivity is such that it permits this desired charge motion, it will also (assuming isotropic target material) allow charges to move laterally over the target face so that even an initial point charge will be spread over a circle of diffusion, the diameter of which will ultimately determine the limiting resolution regardless of the spot size of the scanning beam.

It appears probable therefore that 1500 TV line/in. is a reasonable maximum value for the limiting resolution of pickup tubes for some time to come, and that a practical value for unattended operation of present tubes in a satellite vehicle might well be considerably less than this, say about 1000 TV lines/in.

#### OPTICAL TECHNIQUES FOR IMPROVING THE RESOLVABLE SURFACE DIMENSION

Considerable improvement in the minimum resolvable surface dimension can be accomplished by changing the optical system so that an enlargement of the scene is effected. Increasing the camera aperture from 2 in. to 5½ in. and the focal length from 20 in. to 55 in. would yield nearly a 3:1 picture enlargement; and a minimum resolvable dimension of 185 ft would be reduced to 70 ft. An illustration of the improvement in detail may be found by observing the following figures.

Figure 15 is a high-resolution photograph of a portion of the city of Los Angeles. Figures 16, 17, and 18 are pictures of the same area as viewed by a standard commercial Image Orthicon television tube. Figure 16 is a duplicate of the area seen in Fig. 15; the long dimension represents 17½ mi, or that distance on the earth's surface contained in a single frame of the continuous-coverage satellite television system (800-mi scanning width). It should be noted that objects of approximately 200-ft dimensions are discernible, but a tank farm having 100-ft-diameter tanks appears as a blur.

Figure 17 shows part of the same area enlarged three times (3:1) before it passes through the video system. Here the 100-ft tanks may readily be recognized. The long dimension of this picture (6 mi) represents the area viewed by a satellite having an 80-mi scanning-band width and is thus indicative of the detail resolvable with the 55-in. focal length lens.

---

---

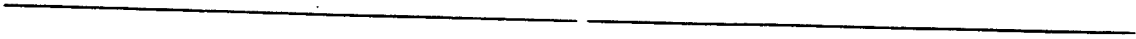



---

---

Figure 18 shows an 8:1 enlargement of a portion of the original scene (Fig. 15). All three pictures were made at the KNBH studio of NBC with the assistance of NBC and RCA personnel. Figure 19 depicts the television camera and the "subject" (Fig. 15), a highly accurate photographic mosaic of Los Angeles prepared by Fairchild Aerial Surveys, Inc. In Fig. 20 are shown the monitoring scopes and the photographic camera recording the pictures on the scope.

These examples are an indication of what can be seen by the assumed satellite television system on a clear, sunlit day.

Of course, as noted previously, scene enlargement can be accomplished only at a sacrifice of scanning bandwidth (keeping the same frame speed limitation). This decrease in scanning width is proportional to the square of the enlargement, so the scanned width with the 5½-in. lens would be about 80 mi instead of 800 mi.

It is believed that a 70-ft minimum resolvable surface dimension would result in a considerable improvement in detail target identification. Large aircraft could be discerned on an airfield, as could revetments, etc.

To incorporate such an optical system in the satellite requires a little thought. An over-all, day-to-day look at USSR and its environs is highly desirable from a weather standpoint, and this can be done only with the 800-mi scanning width (i.e., the 20-in. focal length lens). The possibility of using two separate lens and scanning systems becomes immediately apparent. The second (5½-in. aperture, 55-in. focal length) system could be added with little increase in weight and power requirements and with small decrease in reliability of the over-all system. Thus, effectively, a lens turret would result so that either the 800-mi or the 80-mi system could be cut in on receipt of an appropriate switching signal from the ground monitoring station.

Use of this more flexible television device requires modification of the way in which reconnaissance would be conducted.

Consider first the selection of a proper orbit for the vehicle. If the satellite is placed at 425 mi altitude, the satellite will nearly retrace its path over the earth's surface every other day; this is a desirable condition for the 800-mi scanning system (as pointed out in the discussion on orbits in Section 1). If the satellite followed such a trace *exactly*, then a 320-mi gap would exist between the scanning traces when using the 80-mi lens system. In other words, only targets in 80-mi strips, 400 mi apart, could be seen with the higher-resolution system.

Fortunately, except for a queer quirk of fate, the above exact satellite trace (the number of satellite revolutions integral with two revolutions of the earth with respect to the satellite's orbital plane) could not be attained with present control equipment in placing the satellite in its orbit. A drift, depending on the error in attaining the appropriate altitude and zero orbit eccentricity, would mean that other targets would eventually be scanned by the 80-mi system. To ensure a greater drift, it is probable that planning to place the satellite at either 400 mi or 450 mi altitude would result in a suitable variation in earth traces. The choice of one of these altitudes over the other would, of course, depend on other factors mentioned at various places in the report (transmission range, vehicle size, etc.).

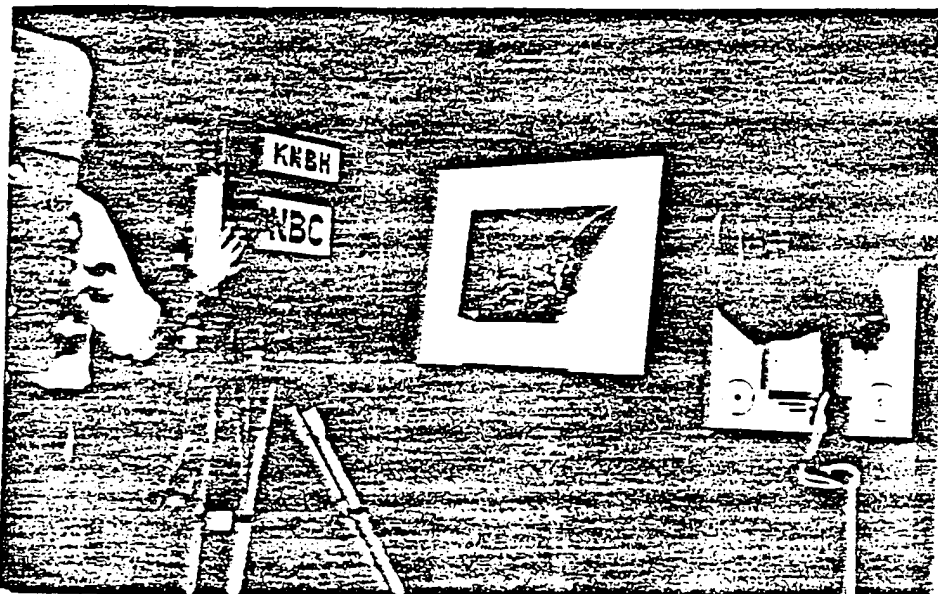

Fig. 19—Photograph of KNBH studio of NBC, with master mosaic of Los Angeles harbor on easel

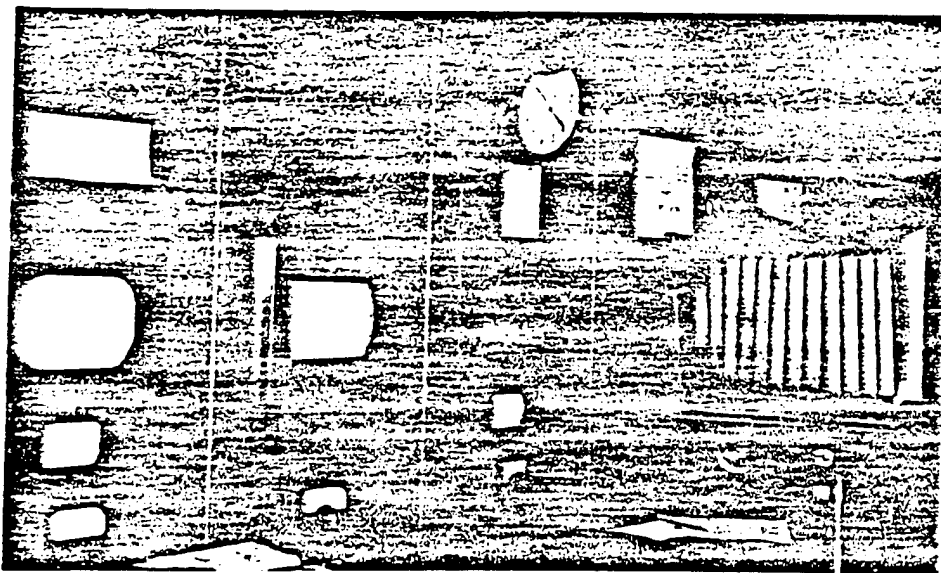

Fig. 20—Photograph of monitoring control room of KNBH-NBC television station, showing scopes and photographic camera set up to record scenes

---

Thus, should the 80-mi system be turned on continuously, eventually (probably within a month) all important targets in Russia could be seen at the 70-ft resolution level.

To recapitulate, two optical-scanning systems are now considered, one having an 800-mi width and the other an 80-mi width. The 800-mi system could be turned on until all targets were covered on the 185-ft resolution level. Subsequent operation would then be either with the 185-ft resolution or the 70-ft resolution system, depending on the choice between weather and targets. There need not be any conflict in this latter decision. Weather observations require considerable clouds (otherwise the weather is fairly well established—fair). Clouds would obscure the targets. On the days that there are no clouds, the targets can be seen and weather observations are meaningless.

Switching on the 80-mi scanning system when the satellite is approaching targets of interest on clear days will eventually result in more or less complete coverage of these pertinent targets owing to the random nature of weather.

Should it be desirable to increase further the scene enlargement, this can be done. Figure 18 illustrates the benefit of an 8:1 enlarging lens. Each frame viewed at this enlargement would represent less than 2 mi on a side, and problems in synchronizing a scanning system to obtain pictures of a useful target are considerable. It is felt that a more fruitful line of endeavor would be directed along the lines of improving the inherent resolution of the television camera tube, or toward another alternative discussed in the following paragraph.

It is pertinent to note that keeping the scanning width constant, but increasing the frame speed from 10 to 30 frames/sec, results in an improvement of resolution at the expense of a more complex optical-scanning system and a large focal length camera. The improvement is significant in both the 800-mi and the 80-mi scanning systems. In the 800-mi system, the minimum resolvable surface dimension is reduced from 185 ft to 105 ft; in the 80-mi system, from 70 ft to 40 ft.

It is not presently known how much time is required to place an entirely different charge distribution on the target of the TV tube. The frame frequency of 30 frames/sec is the same as that used in commercial television. However, in *commercial* television the charge distribution, i.e., the picture, drifts slowly (in comparison to the frame speed) across the tube target as objects in the viewed scene are moved. In the *satellite's* television system, a completely different picture, and thus charge distribution, is experienced with each frame. Thus a frame speed of as high as 30/sec will have to be investigated further, although a 10/sec frequency is believed to be acceptable to the television tube. In fact, the Columbia Broadcasting System's sequential color system places a completely different picture on the tube target at the rate of 144/sec, which would imply that the analysis presented is notably conservative.

## TRANSMISSION OF THE TELEVISION PICTURES

On the basis that the satellite's television camera system can collect valuable information, it is necessary to transmit the pictures from the satellite to surface receiving stations and to record and portray the pictures in useful form. The range at which satellite signals can be received by ground stations will be discussed first, since this

range affects the disposition of the stations and ultimately determines the completeness of coverage of enemy territory by direct broadcast to receiving points in friendly territory. Possible locations of receiving stations was discussed in Section I.

Next, consideration will be given to the tracking system and to the effects of switching the television broadcast reception from one station to the succeeding one. The following subsection is devoted to the antenna gain and to the power required, since these are intimately related to the system employed to track the satellite. Logically following this there is a discussion of the proper choice of wavelength. Finally, the possibilities of interception and jamming of the television signal will be considered.

Before continuing further, however, it is felt desirable at this point to outline the over-all television system. Figure 21 is a block diagram of the proposed system. Component parts will be (and have been) described as they appear in the discussion.

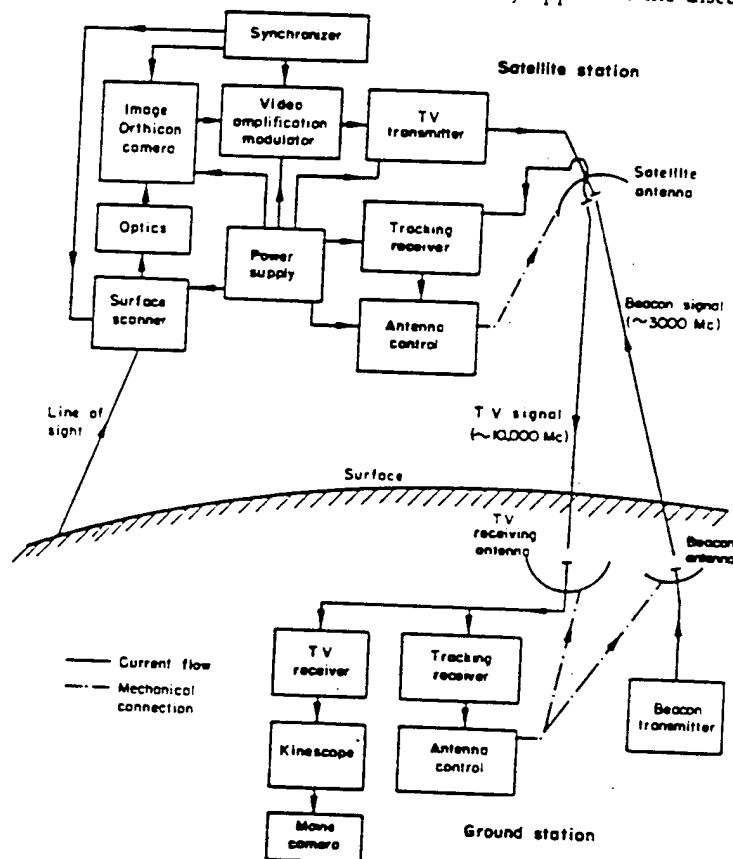

Fig. 21—Block diagram of TV transmission and antenna-tracking systems

#### Range of Transmission

There are quite good reasons for not attempting to track or communicate with the satellite from surface stations when its angular elevation above the horizon is less than

5°. (10) Consequently, this value of the elevation angle has been considered as determining the maximum range over which completely acceptable television transmission should be required. Because of geographic limitations, however, it may be both desirable and necessary to transmit at ranges greater than those indicated by the 5° limitation. An immediately apparent expedient is to consider the use of some portion of the additional range potentially available by transmitting and receiving when the satellite is at an angular elevation of less than 5°. Figure 22 shows maximum radio ranges as functions of altitude at angular elevations of 0°, 2°, and 5°.

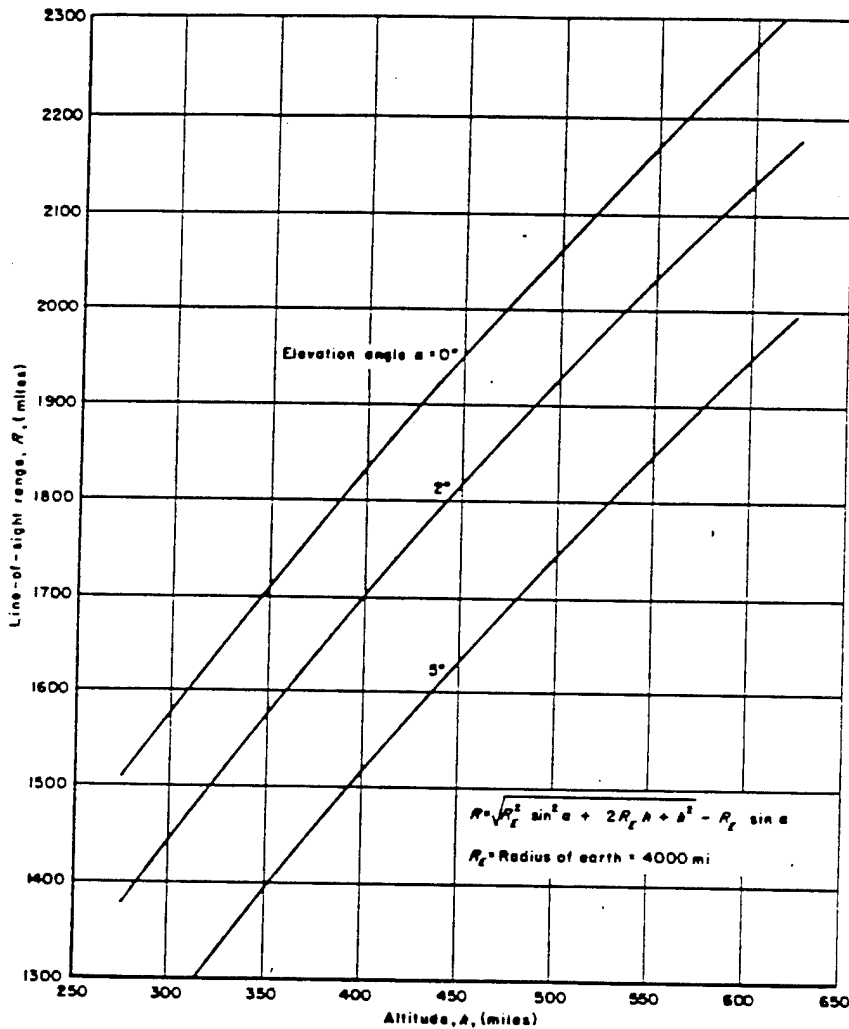

Fig. 22—Maximum line-of-sight radio range as a function of altitude and minimum angular elevation above the horizon

---

Reliable transmission of radio waves several centimeters long can be expected at a  $5^\circ$ -elevation angle; at angles of  $1^\circ$  or  $2^\circ$ , some dispersion will be prevalent. (10) The principal effect will be loss in resolution, but even this may be desirable in place of no picture at all.

### The Tracking System

It is evident that if power requirements are considered, it is necessary for the television transmitter to have a directional antenna which can be oriented toward the receiving station. On the basis of orbital computations, a receiving station will know the approximate location of the satellite at any given time.

A station with an appropriately sized receiving antenna will be able to track a 350-mi-altitude satellite for about 3000 mi. The vehicle traverses the distance in approximately 11 min at an average angular tracking rate of  $15^\circ/\text{min}$  (the rate is faster at the zenith, being of the order of  $34^\circ/\text{min}$ , or  $0.6^\circ/\text{sec}$ ). This implies that the tracking system must be carefully keyed in with the satellite's system and, further (within the limits of reasonable satellite power consumption), that the ground station's antenna should be as small as possible. The diameters of the satellite's antenna and of the ground station's receiving antenna are assumed to be 1 ft and 16 ft, respectively. Thus the size of the ground station's antenna would be small enough to be amenable to reasonable engineering in mounting, etc.

It is proposed that, for reasons of stability as well as of reliability, the satellite's television camera and transmitter system be turned on, warmed up, and adjusted at the start of the flight, and that it be left on continuously thereafter. The satellite will therefore always be ready to televise on demand of the appropriate ground station.

Of the many possible methods by which antenna-tracking could be accomplished, the optimum would be that which minimizes the complexity, weight, and power requirements of the space-borne equipment. On this basis, the most attractive system yet considered is one in which a tracking receiver in the satellite operates on the continuous-wave signal of a ground beacon to direct the satellite antenna toward the ground station, and—once the space-borne tracking is accomplished—the ground station's receiving antenna is directed to follow the satellite by means of an auxiliary tracking receiver operating on the television signal. The space-borne tracker would operate on a microwave frequency different from and considerably lower than that used for television transmission, but would work through the satellite's television transmitting antenna. The ground beacon would work into a directional antenna separate from that used for television reception, but would be slaved to the latter so as to follow the satellite when the ground tracker takes over. The general nature of the operations of the tracking system is described in the following paragraphs.

The 1-ft-diameter satellite antenna is mounted in gimbals in such a manner that it is free to rotate about a vertical axis and so that the antenna axis can assume any angle with the downward vertical up to a maximum of about  $60^\circ$  (the direction of a ray from the satellite in a 350-mi orbit to a ground station at which it subtends to a minimum angle of  $11^\circ$ ; see Fig. 23). The dish-shaped antenna is provided with two feeds: one is fixed on the axis for television transmission at about 10,000 Mc; and the other

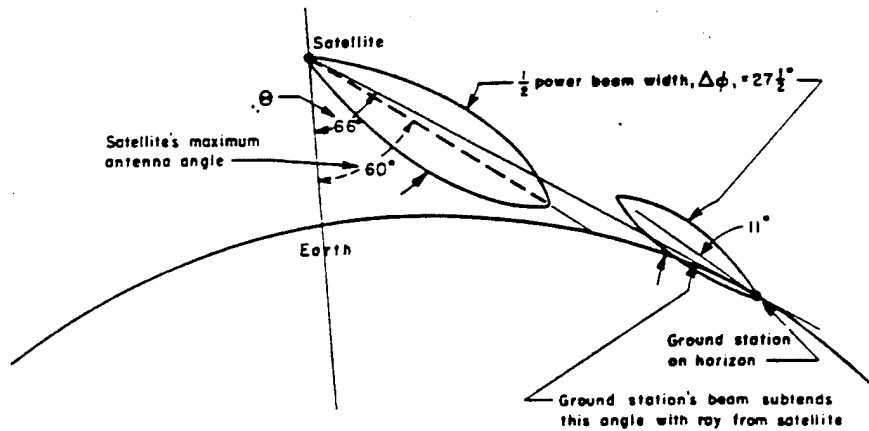

Fig. 23—Schematic diagram of satellite-tracking transmission angles

is offset from the axis and nutates about the axis so that a conical scan is provided for the tracking receiver at some suitable lower frequency, say 3000 Mc. In the search phase, the axis of the dish is maintained at  $60^\circ$  from the downward vertical, the antenna assembly rotates about the vertical axis at a rate of the order of 3 rps, and the nutating feed simultaneously executes a conical scan at a rate of the order of 30 rps. When the ground station appears above the horizon with respect to the satellite, the signals from the ground station's beacon will be received by the conically scanning tracking receiver, which will then operate to disengage the slow search rotation and to maintain the antenna axis in the direction of the beacon, using the conventional servo technique. When the satellite reaches the opposite side of its transit with respect to the ground station, the ground beacon shuts off and the tracker ceases to operate. The satellite's antenna is then rotated about its axis once at the same angle with the vertical as was used in transmitting to the last receiving station. If the next station tracker is not engaged, then the antenna is returned to the primary angle of  $60^\circ$  by stages (probably two revolutions).

This procedure is illustrated in Fig. 24. In the extreme case (provided the next station is not over the horizon), a loss of less than 1 sec in reception may be anticipated. Usually this interval will be about  $\frac{1}{2}$  sec and will not cause difficulty in continuity of picture-area coverage since successive disengagements from one station to the next (on alternate days, for example) can be made at different points in the orbit. The 3000-Mc tracking frequency was chosen, since an included angle ( $\Delta\phi$ ) of  $27\frac{1}{2}^\circ$  will illuminate the satellite from a wide range of succeeding ground stations.

Because of the high, and continuously varying, radial velocity of the satellite with respect to the ground station, the 3000-Mc signal of the ground beacon may suffer a Doppler shift of as much as  $\pm 150$  kc when it is received at the satellite. The satellite's tracking receiver must therefore have an effective bandwidth in excess of 300 kc if the complexities of automatic-frequency search-and-control circuitry are to be avoided. This wide bandwidth implies that a directional beacon antenna of rather high gain



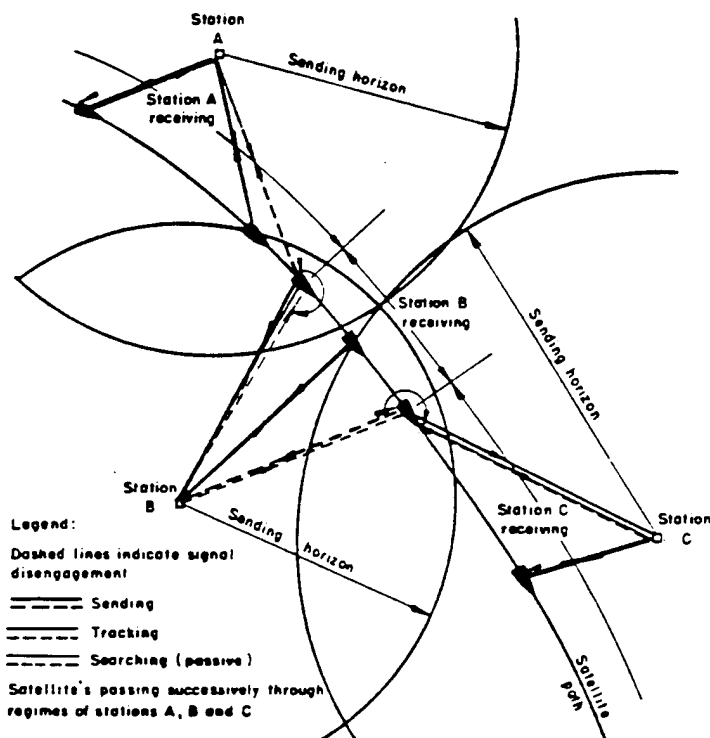

Fig. 24—Schematic illustration of satellite's search-and-signal transmission system

will be necessary if the beacon output power is to be reasonable. Fortunately, it is expected that the establishment of the orbit of the satellite can be made sufficiently precise so that the azimuth angle at which the satellite will appear above the horizon with respect to a given ground station, on a given orbital revolution, may be predicted to within one or two degrees. Hence a beacon antenna having a power gain of about 1000 will yield a broad enough beam to illuminate the satellite when it appears above the horizon.

The design of the ground station's tracker is virtually unrestricted by considerations of circuit complexity and power consumption and could take any of several forms. It could, for example, include a conically scanning tracking receiver similar to that used in the satellite. Such a tracker could use the television transmitter in the satellite as a beacon. The ground station's 16-ft-diameter receiving antenna would have a single feed connected through a power divider to two receivers: one of about 3-Mc bandwidth for television reception and the other of about 400-kc bandwidth for tracking. Both receivers would operate on a television frequency of 10,000 Mc. The feed would be offset from the dish so that a conical scan at a rate of the order of 30 cps would be provided. The search phase would consist in aiming the axis of the dish in the direction of the satellite's scheduled appearance and in oscillating the conically scanning feed back and forth through the axis of the dish in such a manner that the axis of the scan

---

would describe an arc, parallel to and above the horizon, centered on the direction of the satellite. This oscillatory search scan would occur at a rate much slower than the conical scan, say of the order of 3 cps. When the satellite appears, the satellite's tracker first will contact the ground station's beacon, thus aligning the satellite's transmitting antenna with the ground station. The oscillatory search motion of the ground station would then be stopped and, with the axis of the conical scan fixed with respect to the antenna's axis, the entire antenna assembly would be driven by the usual servo system to follow the satellite.

#### Antenna Gain and Power Required

Appendix II develops the relation of antenna sizes ( $d$  for the satellite and  $D$  for the ground station), transmitted power,  $P$ , transmission wavelength,  $\lambda$ , and all the other factors constraining the signal transmission (signal-to-noise ratio, range, etc.). If these latter factors are considered as constant,  $K$ , then the following relation may be stated:

$$P = K \frac{\lambda^2}{d^2 D^2} = \frac{125\lambda^2}{d^2 D^2}, \quad (1)$$

where  $P$  is in watts,  $\lambda$  is in centimeters, and  $d$  and  $D$  are in feet.

The power supplied to the transmitter,  $E$ , is not directly proportional to the output power,  $P$ ; although it is desirable to reduce  $E$  to an absolute minimum, not much can be gained by reducing  $P$  below 4 watts. Using 4.4 watts for  $P$  and an assumed wavelength of 3 cm ( $\nu = 10,000$  Mc) yields  $d^2 D^2 = 256$ . Choosing  $d = 1$  ft yields  $D = 16$  ft. These figures are purely arbitrary; they are based on engineering judgment and may be considerably different from those used in the ultimate system. Wavelength,  $\lambda$ , is discussed later.

It is assumed in the above formula that the two antennas are highly directional, with half-power beamwidths of  $0.80^\circ$  and  $13^\circ$  for the ground and the satellite antennas, respectively. Should less directional antennas be employed, considerably greater transmitter power would be required.

Since the antenna beamwidths are small compared with the total of the solid angles over which communication will be required, means must be provided for aligning the axes of the two antennas shortly after the satellite appears above the horizon at a given ground station and for maintaining that alignment as the satellite passes by in its orbit. This has been described previously.

#### Choice of Transmission Wavelength

While the optimum frequency for television transmission between the satellite and the surface receiving stations will undoubtedly lie in the centimeter wavelength band, its precise value will be determined as a compromise of many factors. One prime consideration, however, is that of minimizing the required power output of the satellite transmitter, which, other things being equal, may be accomplished by maximizing the product of the satellite's transmitting antenna gain and the transmission efficiency of the circuit. A steerable aperture antenna (such as a conventional paraboloid) is required

---

for transmission from a satellite in an oblique orbit, and its gain, for a given aperture area, will be inversely proportional to the square of the transmission wavelength, so that, from this point of view, the frequency should be as high as possible. The transmission efficiency at very high frequencies will be largely determined by atmospheric absorption (water vapor and oxygen) and by losses caused by scattering due to condensed cloud and rain droplets, the total atmospheric losses increasing rapidly with the decrease in wavelength in the high microwave region. (See, for example, Fig. 50, page 109. The optimum wavelength will depend on the maximum antenna size, on the minimum satellite elevation angle at which transmission is required, and on the least favorable meteorological condition, which is likely to be encountered at the ground station. For example, with a 1-ft-diameter transmitting antenna on the satellite, the optimum frequency for transmission at a minimum elevation angle of  $5^\circ$  to a ground station located in a region in which moderate rain is falling at the rate of 15 mm/hr may be shown to be about 15,000 Mc (2-cm wavelength); the optimum wavelength for transmission under the same conditions, but through a tropical downpour, would be about 5000 Mc (6-cm wavelength). Many other considerations enter into the choice of frequency, among which are system losses, ground-receiving, antenna-tracking accuracy, efficiency and reliability of transmitting tubes, etc., the ultimate optimum probably being greater than 5000 Mc and less than 15,000 Mc (10,000 Mc has, of course, been employed in this study).

Transmission of the picture from the satellite to a surface receiving station, as well as the method of presentation or assembly of individual scenes into a meaningful whole, presents problems regarding deterioration of the clarity of the televised picture, which are discussed more fully in subsequent parts of this section. Transmission should be done with a large enough frequency bandwidth so that this part of the over-all system is equivalent to a considerably higher resolution than that component limiting the resolving power, namely, the TV tube.

### Enemy Interception and Jamming

**Detection and Tracking by Radar.** The microwave-radar cross section of the satellite is estimated as averaging less than about  $1 \text{ m}^2$ . Detection of so small a target in rapid motion and at slant ranges, which vary from a maximum of about 1700 mi on the horizon to a minimum of 350 mi at the zenith, can be shown to be well beyond the capabilities of the most powerful American radars, either now existent, under development, or being proposed.

It is conceivable that the satellite might be detected and tracked by a radar designed expressly for the purpose, one that employs narrow-band techniques at low vhf frequencies at which relatively high average power is available and at which the satellite might behave as a resonant scatterer of a much higher radar cross section. But the frequencies in question (20 to 40 Mc) are subject to severe ionospheric attenuation and refraction effects. The antenna of such a radar would be enormous, with an aperture area measured in thousands of square meters. The difficulties involved in searching for and following a rapidly moving object with such equipment are obvious. Further,

---

even if the system could be made to work, its accuracy and information rate would probably be too low to be useful.

**Detection and Tracking by Passive Techniques.** The power density of the television signal transmitted from the satellite will be from  $10^{-12}$  to  $10^{-10}$  watts/m<sup>2</sup> at points on the earth's surface illuminated by the main beam of the satellite's transmitting antenna and will be of the order of  $10^{-15}$  to  $10^{-13}$  watts/m<sup>2</sup> at surface points outside the beam.

There is little doubt that an enemy equipped with suitable interceptor receivers could detect and track the satellite by means of its television signal and from a site sufficiently close to a friendly ground station's receiving station (within about 40 to 200 mi) to be illuminated by the main beam of the satellite's transmitting antenna. The equipment required would be relatively conventional, based on any of a variety of direction-finders and passive radar techniques. The tracking would be in direction only, with crude range information supplied by triangulation from the data obtained at two or more sites. As a primary difficulty would lie in the first acquisition of the satellite's signal, the enemy, unaided by intelligence information, would have to search through a wide band of frequencies and a solid angle of nearly  $2\pi$  for a source of radiation which would be above the horizon at a given site for a period of only a few minutes per day.

Detection of the satellite's signal by the enemy from sites not illuminated by the main beam from the satellite would be very difficult. While it could be done, so doing would require the use of narrow-band search receivers worked into very large antennas. The probability of making an interception under these conditions would be of the order of 1000 times less than the already low value applied to the more favorable case previously discussed.

**Interception of the Satellite's Transmission (Monitoring).** Television transmission from satellite to surface would require high-gain tracking antennas at both ends of the circuit. The enemy could receive the message from the satellite only if he had comparable tracking equipment\* and then only if he managed to acquire the satellite's tracker before a friendly receiving station did. Successful interception would require that the enemy know almost every detail of the system and its operation.

**Interference and Other Countermeasures.** The television link can be relatively easily jammed by an enemy who knows the approximate locations of the ground receiving station and the frequency of transmission and who is able to get a jammer within line-of-sight range of a ground station. Even though the ground station's receiving antenna is highly directional (peak gain probably in excess of 20,000) and tracks the satellite, so that the jamming signal will be discriminated against by a factor ranging from a minimum of 1000 (for 30 db peak-side lobes) to an average of more than 20,000, the jammer can take tremendous advantage of the pulse transmission. For example, an air-borne pulse jammer of 10- to 100-kw peak output worked into an antenna

\* It would not be necessary for the enemy actually to receive the signal so long as he was able to acquire the satellite's antenna by sending in the 300-Mc tracking signal. However, this type of interception (or jamming) could be overcome by requiring a pulsed tracking signal, similar to an IFF system.

---

of modest gain (100 to 10) carried by an aircraft at 20,000 ft to within 200 mi of the receiving station could prevent reception of a usable picture. Such jammer powers (peak pulse, at a duty cycle of about 1 per cent) and antenna sizes are comparable with, or modest compared with, those of ordinary air-borne radars, and spot-frequency jamming is therefore quite feasible.

If the enemy can be denied access to within line-of-sight range of the ground stations, the television system will be relatively invulnerable to interference by the enemy. Countermeasures applied at the satellite-end of the circuit presume possession by the enemy of adequate search and tracking facilities (the difficulties of which were previously discussed) and can be directed only against the satellite's tracking receiver.

## RECEPTION AND PRESENTATION OF THE TELEVISION SIGNAL

### Reception

A description has already been given of the ground station's receiving antenna and tracking system. Consideration is now devoted to the assimilation of the TV pictures after they have arrived at ground level.

Concurrently to read and interpret information on a single television screen at the rate of 10 completely different frames per second is obviously impossible. Furthermore, each ground station receives only a piece of the target system under scrutiny. Thus it appears necessary to record the transmitted data with as little loss in resolution as possible and to forward it to a central evaluation center.

At a first glance, it would seem that a prodigious amount of film would be required to record all the pertinent television frames transmitted. However, analysis reveals that 2.9 hr/day, at most, are spent over USSR and her satellites, China included (see Fig. 25). At 10 frames/sec, 2.9 hr are equivalent to  $1.0 \times 10^5$  frames/day. It has been shown previously that one satellite will observe a given area only on alternate 35-day periods in daylight. Thus, for the first 35 days' operation,  $3.5 \times 10^6$  frames would be recorded. This is 265,000 ft of 35 mm camera film, or about that used in filming several feature-length movies.

It is believed that during the first 30 to 40 days' operation a fairly comprehensive picture of the USSR would be obtained, and subsequent operations would be concentrated on specific target systems or areas, perhaps with the narrow-scanning-width lens system previously described.

The equipment required at any forward receiving station is not complex. The receiving antenna has already been discussed. An ordinary television receiver will probably suffice for monitoring purposes (to see if the picture quality is satisfactory). Its viewing scope, however, must have a high-persistence screen which will project about one frame out of a hundred.

For recording, a second television receiver is needed. Its scope must be as large as possible and its electric beam spot size must be reduced to a minimum; in short, the whole set must be tailored to the criterion of putting the image on the screen with as little loss in resolution as possible.

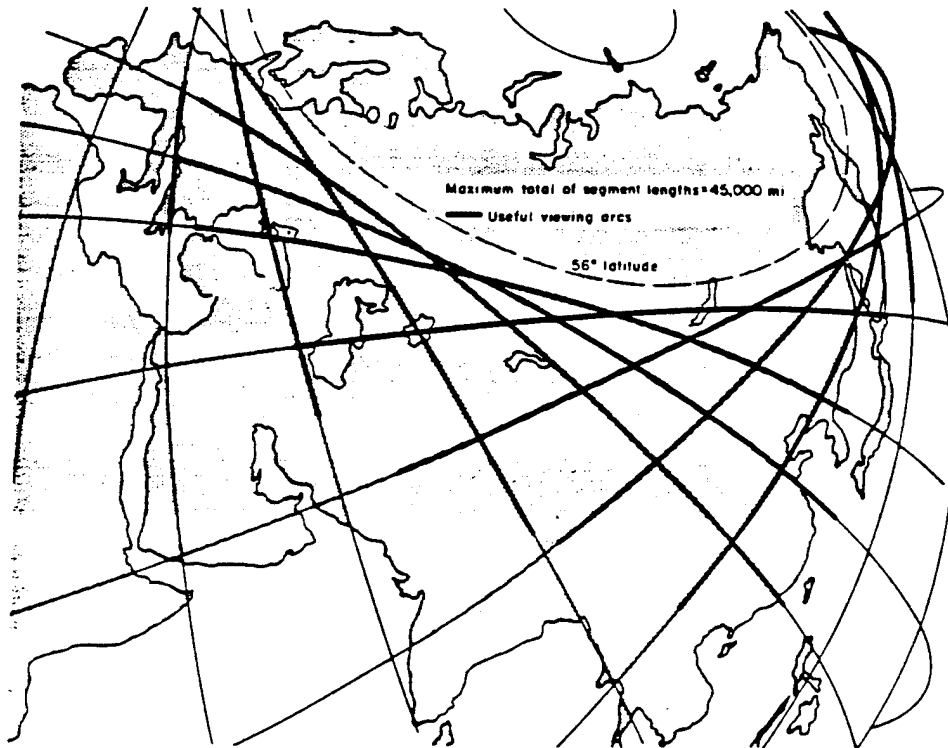

Fig. 25—Segments of satellite's traces used in viewing targets of military interest

The image will then be reduced by camera-optics to the appropriate film size; 35 mm may be adequate, but if a significant amount of detail is lost, then 70 mm can be employed. The film does not have to be very "fast," but should be of a fine-grain variety.\* The camera will be similar to a movie camera but will operate at about one-half the frequency.

Each forward station will be furnished with a time schedule for operating the cameras computed on the basis of the satellite's orbit. Such a schedule will vary from day to day, as mentioned in the discussion on orbits. Some sort of time coding will be included with each frame; a feed-back from the tracking-antenna control will also be fed into this coding, but this is only a crude location device to show up any gross errors in evaluation.

#### Presentation

The *central evaluation station* will receive the composite films from the forward stations and assemble the story into an integrated whole. Standard photogrammetric techniques call for synchronizing one or more sets of films, together with overlays, etc.,

\* Such expedients as, for example, using blue sensitive film with a blue cathode-ray screen can be used to bring out certain details in the viewed scene.

---

to aid in interpretation of results. In such a device, the frames are projected in a mosaic form and compose as the scenes appear on the earth. Also projected could be a master overlay made up of geographical coordinates and, later, after a number of films are taken, of that area of the ground already filmed. The over-all area can be enlarged to any extent necessary for rapid determination of the worth of the films being evaluated. For instance, if a large area is covered by clouds, then just those frames having glimpses of the ground could be separated for subsequent addition to the master mosaic of the USSR.

The cloud pictures would be placed on a larger-scaled photomap so that daily weather maps could be made and preserved.

The entire presentation system should be simple, rapid, reliable, and amenable to standard evaluation techniques.

#### SUMMARY

To summarize, a 350-mi altitude satellite, having an  $f/10$ , 2-in. aperture, 20-in. focal length, Image Orthicon TV camera of 1000 TV lines/in. with a speed of 10 frames/sec, would be capable of resolving scenes of contrast greater than 20 per cent to about 200 ft. Transmitting and receiving antennas for the described system will require careful analysis and design, but their accomplishment does not present any serious research problems. Presentation of the viewed scenes by photographic and photogrammetric methods appears within the limits of known, practiced techniques.

Such a system, employing presently available equipment, is considered satisfactory for both weather and pioneer terrestrial reconnaissance. However, in order to obtain acceptably detailed target evaluation or bomb-damage assessment, the minimum resolvable surface dimension will have to be improved; several possible methods are suggested.

For example, by keeping the frame speed constant but optically reducing the field of view and thereby reducing the scanned bandwidth on the ground, acceptable values for most terrestrial reconnaissance can be attained with present television tubes. This results in not having a daily coverage of the entire target area.

Other means of improvement of the resolvable surface dimensions are an increase in the inherent tube resolution (an increase of about 50 per cent is visualized at this time) and an increase in the frame frequency to 30/sec (about 45 per cent improvement of resolvable surface dimension).

The estimated over-all power, weight, and space requirements of the electronic transmitting system are 350 watts, 300 lb, and 2.25 ft<sup>3</sup>, respectively. A breakdown of the weight and power data is given in Table 2, page 46; the components are discussed further in Appendix II.

---

### III. ORBITAL ATTITUDE MEASUREMENT AND CONTROL

The discussion in this section will be confined almost entirely to the problems concerned with the measurement and control of the vehicle's position orientation relative to its flight path and to the earth after the satellite is established in its orbit. However, for the purpose of completeness and continuity, the take-off trajectory to the orbital altitude and the vehicle's guidance and control during this phase will be mentioned briefly.

#### PREORBITAL ASCENT

The complete preorbital trajectory for a 1000-lb-payload, 350-mi-orbital-altitude, two-stage, satellite vehicle consists of about 2 min of booster-powered ascent, then approximately 2½ min of the second stage of powered ascent, followed by a 20-min coasting period to the orbital altitude, at which point power is applied momentarily to provide a final boost, or "kick," into the proper orbit.

It is expected that trajectory (preorbital) guidance and control of the satellite will be substantially similar to that used for long-range guided missiles, with the obvious exception of positioning the vehicle in the orbit.

The two most critical points in the trajectory are at the end of the coasting before the final boost into the orbit and at the end of this boost before the orbital-attitude-control system starts working. At the end of the coasting period, the angle of attack of the vehicle should be less than 2° in order that the final thrust will put the satellite on its orbit within the required accuracy of  $\pm\frac{1}{2}^\circ$  from the horizontal. At the latter point, the condition of zero angular velocity around all three axes is much more important than any reasonable angular attitude error. Four small control motors are used during this portion of the ascent; as their force is tapered off, control becomes increasingly fine until the virtually simultaneous shutoff of the rocket-powered booster control and inception of the orbital attitude control. It is thought that such a vernier-type control will be adequate not only to establish the satellite in its orbit as a point mass, but also to orient the vehicle itself relative to both the earth and the orbit.

The guidance system used during the trajectory—essentially that developed for the V-2 and described in Ref. 7—is unchanged, and it appears even more promising as the accuracy attainable by accelerometers and free gyros improves. In the case of free gyros, a drift of 0.1°/hr seems to be presently possible, whereas the required accuracy at the moment of orbital boost is 0.83° in 20 min.<sup>(3)</sup>

The required accuracy of the accelerometers is more nearly marginal. The allowable error in velocity is 66 ft/sec,<sup>(3)</sup> by assuming that this is the result of a purely percentage error in the accelerometer output (i.e., no zero point error), it can be shown that the fraction of the indicated reading by which the accelerometer is in error is, for this case, equal to 0.0028; further, the allowable zero point error, assuming no percentage error, is 0.0017g. Inasmuch as sensitivities and drifts of one-tenth these values have been reported,<sup>(15)</sup> preorbital guidance problems appear amenable to solution.



---

## ORBITAL ATTITUDE REQUIREMENTS

Once the satellite is in its orbit, the problem of attitude control—maintenance of roll, pitch, and yaw axes in relatively fixed positions to a reference frame (in this case, the earth)—is important for the following reasons. First, the auxiliary powerplant (see Section IV) requires constant conditions, e.g., a "cold" side for the purpose of radiant waste heat. Secondly, useful television scanning demands that the mid-point of the television scan always point toward the center of the earth. Thirdly, antenna-positioning requires a relatively stable vehicle attitude relative to the earth.

The accuracy required for television scanning is not too restrictive; one or two degrees' variation in any direction, which will cause picture misalignment of less than one frame, is acceptable. It is desirable, however, that the rate of corrective change be slow, of the order of several seconds or more, so that the register of frames in any single camera sweep will not be affected. Although basic misalignment can be rectified at the evaluation center by means of geodetic check points, large variations between successive frames are highly undesirable because the distances between such check points are great; moreover, excessive evaluation time would be wasted if the position of each frame had to be rectified. Thus rate control of both first and second orders will probably be required. The requisite conditions for either antenna-positioning or heat-dissipation systems appear to be less stringent than those for the television system and therefore will not be considered further.

Within the limits stated above, then, the orbital control system must be able to keep the vehicle heading essentially tangent to and in the plane of the orbit (pitch and yaw, respectively); the roll angle and rate must be substantially zero.

The basic rotation in pitch, instantaneously tangent to the orbit so that the bottom of the vehicle always faces the earth, requires that the satellite make one complete revolution about its pitch axis for each revolution of the satellite around the earth. Hence the vehicle continually noses down. But this orientation must be a controlled one since this vehicle position is basically unstable (in the stable-vehicle position, its nose tends to point toward the center of the earth).

Finally, since the power available during the orbital period is limited, the attitude control system's power requirements should be held to a minimum.

### Attitude Sensing

As stated in RAND's earlier study of satellite stability and control,<sup>(7)</sup> it is impossible to consider any system for a preset orbital control which programs the heading of the vehicle as a function of time, because an extremely small error in the time scale of such a program results in a cumulative error in the heading of the vehicle in the orbit. Thus any attitude control of the vehicle must be based on measurements made within the vehicle itself at the time the corrections are necessary.

Orbital attitude references in pitch and yaw are as previously reported,<sup>(7)</sup> where pitch and yaw angles relative to the direction of motion can be sensed by using orifices and measuring pressures with ionization gauges, as shown by an order-of-magnitude calculation in Appendix III. The static and dynamic pressures appear to be within the

---

range of feasibility; however, detailed studies have not been made. Pressure requirements for the instruments may be a compromising factor in the choice of orbital altitude.

A previously proposed system which made use of the earth's magnetic field for roll reference may still be adequate for the relatively coarse attitude control necessary for nontelevising, experimental vehicles placed on equatorial orbits. For television transmission from equatorial, polar, or oblique orbits, however, such a roll-sensing system is inadequate not only because of the more stringent requirements imposed by the television transmitter half-power beamwidth, but also because of the changing magnetic fields in either polar or oblique orbits. A star-tracking system, using a satellite's orbital zenith star, is applicable to any orbit whose inclination to either the earth's equator or axis is small. For practical oblique orbits, however, some other means for roll stabilization is required.

One system, suggested for application to long-range surface-to-surface missiles,<sup>(16)</sup> proposes guiding on the horizon by means of the heat radiated from the surface of the earth. By treating the earth as a black body at 246°K, the radiant energy emitted is 0.021 watts/cm<sup>2</sup>. It is shown in Appendix III that if an image of the horizon is formed by an optical system, the power incident on 1 cm<sup>2</sup> in the image plane equals 0.021/8(*f* number)<sup>2</sup> watts for the earth's portion of the image and practically zero for the "sky" (interstellar space). Infrared detecting devices having the required sensitivity and response time are currently available.<sup>(17)</sup>

Two detecting units which maintain the horizon centrally in the field of view will be required, one on each side of the vehicle; a comparison of the two instruments yields a measure of the roll angle. It might be possible to maintain adequate roll control with only one such device, depending on the orbital altitude variation. For example, if the eccentricity of the orbit causes the altitude to vary  $\pm 50$  mi from a nominal 350-mi value, a single unit would allow a roll angle of 3°, which is the corresponding change in the dip of the horizon. This amount of roll might be intolerable because the half-power beamwidth of the television transmitter might be of the order of 2°, hence two infrared horizon-seekers would be required for this case.

#### **Attitude Control**

As stated earlier in this section, as well as in the previously reported studies,<sup>(17)</sup> the power required for attitude control should be as little as possible. With this in mind, two methods of effecting the necessary degree of control appear worthy of detailed consideration: (1) control by means of a system of three flywheels with mutually perpendicular axes<sup>(17)</sup> and (2) control by means of precession of gyroscope.<sup>(18)</sup> In either of these schemes, control is achieved by transferring momentum between the flywheels, or the gyros, and the vehicle.

#### **FLYWHEEL SYSTEM**

The flywheel system, described in RAND's previous satellite studies, controls the vehicle by changing the angular momentum of the flywheel system. whereby the vehicle's angular velocities are reduced to their steady-state values in accordance with the principle

of conservation of angular momentum. If changes in yaw, pitch, or roll are considered separately, or are small,\* the basic equations governing the flywheel control are

$$\begin{aligned} (\omega_j I_j)_{\text{vehicle}} &= (\omega_j I_j)_{\text{flywheel}} \\ \cdot (\omega'_j I_j)_{\text{vehicle}} &= (\omega'_j I_j)_{\text{flywheel}} \\ \dots \dots \dots \end{aligned} \tag{2}$$

where  $I_j$  and  $\omega_j$  are the moment of inertia and angular speed, respectively, about a principal axis, and where the flywheel axes nearly coincide with the principal axes of the vehicle.

For complex motion, or for large changes in direction, the above equations do not hold, because cross-product terms would also have to be considered. This, of course, means that the motion of each of the flywheels has to be compensated for the motion of the other two. For example, it is obvious that a 90° roll, though intolerable, reverses the roll of the pitch and yaw flywheels in a manner similar to reversals in aircraft rudder and elevator controls, the difference in the analogy being that a change in the satellite's attitude does not cause its flight path to change.

If the condition of zero attitude angular velocity (around all three axes) of the vehicle with respect to inertial space exists at the start of the orbital attitude control, then, regardless of the magnitude of any subsequent attitude error, the flywheels will be at rest after the error has been corrected if they were at rest before the correction was made.

The equations of motion which the flywheel control computer must solve have been resolved for small values of the variables—i.e., by the method of perturbations—and are presented in Appendix IV.

### GYRO SYSTEM

The gyro precessional system for the satellite's orbital attitude control, first presented by the Glenn L. Martin Company, is described fully in their report,<sup>(18)</sup> hence no more than a brief summary of the proposed system is given here. In this case, the correcting moments required for proper orientation of the vehicle relative to its orbit are supplied by means of three groups of reactional gyros with four gyros in each group. For summary purposes here, each group may be considered as a single gyro; their effective spin axes are mutually perpendicular and coincide substantially with the principal axes of the vehicle. The additional gyros in each group are necessary to compensate for the cross-product terms which arise even in the first-order terms of the gyro equations of motion. The attitude-sensing or measuring means previously described are applicable to the gyro as well as to the flywheel system.

The reactional gyro is essentially a rotor turning at constant velocity about its spin

\* If the flywheels attain any appreciable speed, precessional forces enter in, even for small attitude changes, e.g., the pitch moment acting on the rotating yaw flywheel will cause the vehicle to roll, and the simplified equations are not applicable. This effect, a gyroscopic interaction between flywheels, is precisely that used to exert control forces in the gyro system to be described below.

axis; when the spin axis is rotated with respect to the vehicle, the gyro produces a reactional moment upon its support. In other words, and as shown in Fig. 26, if the axis of a gyroscope is displaced by a disturbing torque, a precessive torque about a third axis results. The axis of the resultant torque is mutually perpendicular both to the original gyro's spin axis and to the axis of the disturbing torque.

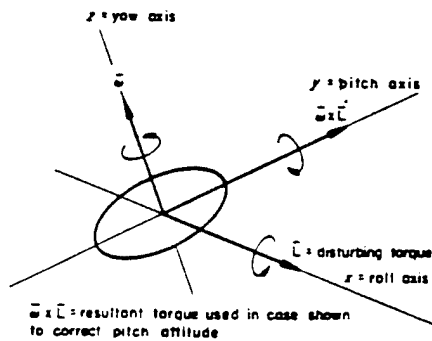

Fig. 26—Gyro precession

As with the flywheel system, and as implied previously, small changes involve only principal terms in the control-motion equations. More complex changes in either system require the use of a computer of the type associated with auto-pilots. Such a mechanism

should not be difficult to develop but may require extension of the contemporary art so that it will operate with a high degree of reliability, at a low power, and under the conditions of no appreciable atmosphere or gravity.

#### SUPPLEMENTARY ORBITAL ATTITUDE CONTROLS

In the event that disturbing perturbations of the satellite cause large deviations from the desired attitude, it may be necessary to provide coarse attitude control by means supplementary to the flywheel or the gyro systems. Small solid rockets of various thrust values might be used to effect such attitude corrections. An alternative scheme might employ a pressure bottle and several series of valves.

Furthermore, in the course of a year, the satellite will make more than 5000 revolutions about the earth. Although the amount of drag per revolution is small, an eccentricity of presented frontal area—drag—relative to the center of the mass will require considerable energy expenditure into the attitude control system during the year. Therefore, some form of drag-trim tabs should be provided; for example, a simple tab whose area is several times the estimated area of eccentricity could be inserted into the slipstream when the flywheel speed or gyro torque exceeds a specified limit and withdrawn when the speed or torque drops below a lower limit.

#### POWER AND WEIGHT REQUIREMENTS

The power requirement of the orbital control equipment is very difficult to estimate within a reasonable degree of accuracy because of the absence of any appreciable gravitational effect at the proposed orbital altitudes. Furthermore, the frequency of occurrence of disturbances as well as of the response time required for their correction is not readily determinable because there should be few, if any, disturbances (see Appendix IV). However, it can easily be shown that an orbital attitude control is necessary because, as previously stated, the satellite's nose-first attitude is inherently unstable in the earth's gravitational field. Moreover, it is reasonable to assume that the power required for

---

attitude control will be small compared with that required for the television camera-transmitter system. Accordingly, it is estimated that the power required by the orbital attitude control system is 130 watts; the system weight is estimated at 280 lb. A breakdown of these estimates is given in Table 2, page 46.

#### **SUMMARY**

To summarize briefly the foregoing, current developments in long-range missile guidance and control systems indicate that the accuracy required during the trajectory (or preorbital) phase of the satellite is well within the realm of possibility. Attitude sensing and control during the orbital phase will require somewhat more extensive development, particularly with regard to the special reliability and environmental requirements. However, it appears that the proposed methods for establishing the necessary attitude references, as well as the subsequent sensing and control, are also amenable to reasonable solutions.

## IV. AUXILIARY POWERPLANT

The reconnaissance satellite requires a continuous supply of electrical energy for the operation of the television camera-transmitter and attitude control systems, as well as of miscellaneous equipments, while the vehicle is in its orbit. It is estimated (see Table 2) that 500 watts will be required continuously for either the 40-day period, which corresponds to the initial useful period of the 56° orbit, or the 1-year period, and, further, that this power should be supplied by a system whose total weight is about 250 lb for the 1000-lb payload.

**Table 2**  
ESTIMATED POWER AND WEIGHT REQUIREMENTS FOR THE  
1000-LB-PAYLOAD RECONNAISSANCE SATELLITE

Components	Payload Weight (lb)	Power (watts)
Television Equipment:		
Camera tube, optical-scanning system, circuitry	145	230*
Transmitter and modulator	20	50
Tracking receiver and antenna control circuitry	10	30
Antenna and servo motors	10	20
Power divider	15	20
Housings, mountings, and climatizing equipment	100	...
Subtotal	300	- 350
Attitude Controls:		
Flywheels	150	...
Motor, drives, and servo circuitry	90	70
Piranni gauge	10	20
Infrared sensing	30	40
Subtotal	280	- 130
Auxiliary Powerplant:		
Regulator	20	20
Powerplant	250	+ 500
Subtotal	270	+ 480
Miscellaneous Weight Allowance:	150	...
<b>TOTALS</b>	1000	0

\* Present Image Orthicons have a 300-watt power requirement but are not designed for the express purpose of saving power.

Since electricity is transitory in nature and cannot be stored in a practical way,\* some

\* A battery stores chemical potential energy, not electricity.

---

other form of energy must be provided (or acquired, in the case of solar energy) for subsequent conversion in the satellite.

Conventional means of producing the required amount of electricity are completely unsuitable to a satellite for periods of more than a few days. To illustrate this, consider the previously reported,<sup>(9)</sup> typical auxiliary powerplant using a chemical fuel, hydrogen peroxide; the fuel alone required for a year's production of 500 watts would weigh approximately 30 tons. Consequently, either nuclear or solar energy, both of which were considered in the earlier works,<sup>(9)(12)</sup> must be employed.

In addition to a relatively long duration of continuous operation, there are other more or less stringent requisites of the satellite's auxiliary powerplant:

1. It must survive initial accelerations of the order of 10g while the satellite is being placed on the orbit.
2. It must operate unattended for the duration of the useful satellite's life.
3. It must operate in a vacuum. There is no air for combustion purposes and there are no convenient convection currents to carry away excess heat. Lubricating oils will tend to vaporize and electrical properties of conductors will be affected.
4. Excess heat must be dissipated by radiation from the satellite's skin; this is a severely limiting factor for heat engines.
5. No gravitational field exists, and thus liquids and vapors must be forcibly separated. Convection currents must be built into heat-transfer devices.
6. The powerplant must be amenable to handling on the ground during the launching phase of the vehicle.
7. As stated, it is desirable to have an over-all powerplant weight of no more than 250 lb, although weights as high as 1250 lb may be acceptable (by the expedient of going to a larger satellite with a 2000-lb allowable payload instead of the assumed 1000 lb).

In view of the above-noted constraints on the satellite's auxiliary powerplant, two heat-engine systems emerge as promising solutions to the problem. The systems are similar in that each employs a radioisotope beta emitter of the appropriate half life as the heat source, each has a reciprocating power conversion device, although of differing types, and each drives a conventional electric generator to produce electricity. The first to be discussed operates on a closed vapor cycle, like a steam engine, and is an extension of the system proposed in Ref. 10; the second to be considered is a closed-cycle gas engine.

As is well known, any heat engine must have a cyclic operation and must include a heat source and a heat sink, or cooler, in addition to a converter for changing available heat energy into more useful mechanical energy. Differences between the various engines arise through the ways in which the working fluid is used. If the working fluid changes phase during the cycle (i.e., is liquid during one stage and gaseous at another), the process is termed a vapor cycle or vapor engine. If the working fluid remains in the gaseous phase throughout the entire cycle, it is designated as a gas engine. Basic differences also exist in the way that the cycle operates, depending not only on the phase of the working fluid, but also on the temperature and pressure levels employed.

---

The two systems, and their more important components, will be discussed separately, and a brief comparison of the two will be presented in the summary at the end of this section. Other possible fuels, including solar energy as well as additional types of energy conversion devices, are described in Appendix V.

### THE VAPOR ENGINE SYSTEM

The basic cycle of the vapor engine system is essentially the same as that used in steam generating plants for many years. Notable differences, such as the type of heat source as well as reliability, gravitation, unattended duration, and weight problems, have already been mentioned. Nevertheless, a complete description of the system will be made, even though some duplication of previous effort may result; for example, a vapor cycle using mercury as the working fluid, as will this one, was proposed in a previous satellite report.<sup>(9)</sup>

A schematic diagram of the complete vapor-cycle system is shown in Fig. 27. The essential elements of the system are: a radioactive heat source and regulator, which provide heat for the phase change of the working fluid from liquid to vapor; a reciprocating power converter and electric generator, whereby the heat energy is changed to electricity; a heat sink, or condenser, to accomplish the phase change of the fluid back to a liquid; and the attendant heat exchangers to convey waste heat to the satellite's skin for dissipation by radiation.

A temperature-entropy diagram of the cycle is given in Fig. 28. The liquid mercury is pumped into the boiler under 100 psia pressure (point A). It is heated in the boiler to a temperature of 907°F (point B), which corresponds to the boiling point of mercury at 100 psia pressure. It is further heated under these latter conditions until all the mercury is in the vapor state (point C). The fluid is then expanded through the power converter (as represented by the dashed line C-D). Heat energy equivalent to the difference in enthalpies between points C and D is changed first into mechanical energy and subsequently into electricity by a conventional 300-volt d-c generator. The fluid at point D is largely gaseous (2 psia and 505°F) and must be returned to the liquid state at A' by means of the condenser; the heat extracted in the cooler is radiated to outer space by the satellite's skin. Upon reaching point A', the mercury is liquid at 2 psia and must be pumped to 100 psi pressure corresponding to point A. Since the fluid is liquid at A, the pressure increase requires only about 2 watts of energy, or 0.4 per cent of the engine output, thus indicating a highly efficient process.\* (Later, in discussing the gas engine, it will be noted that its top-cycle pressure requires compression of a gas, which requires a considerably greater percentage of the powerplant output and therefore yields an inherently lower engine efficiency.)

#### The Heat Source

As stated in the introduction to this section, the heat source proposed for the satellite's

---

\* It may be noted that the resultant *ideal thermal efficiency* =  $(1366^{\circ}\text{R} - 964^{\circ}\text{R}) / 1366^{\circ}\text{R} = 29.45$ , which is a rather low figure. This is more than offset by the vapor engine efficiency of 51 per cent, which results in an over-all powerplant efficiency of 15 per cent.



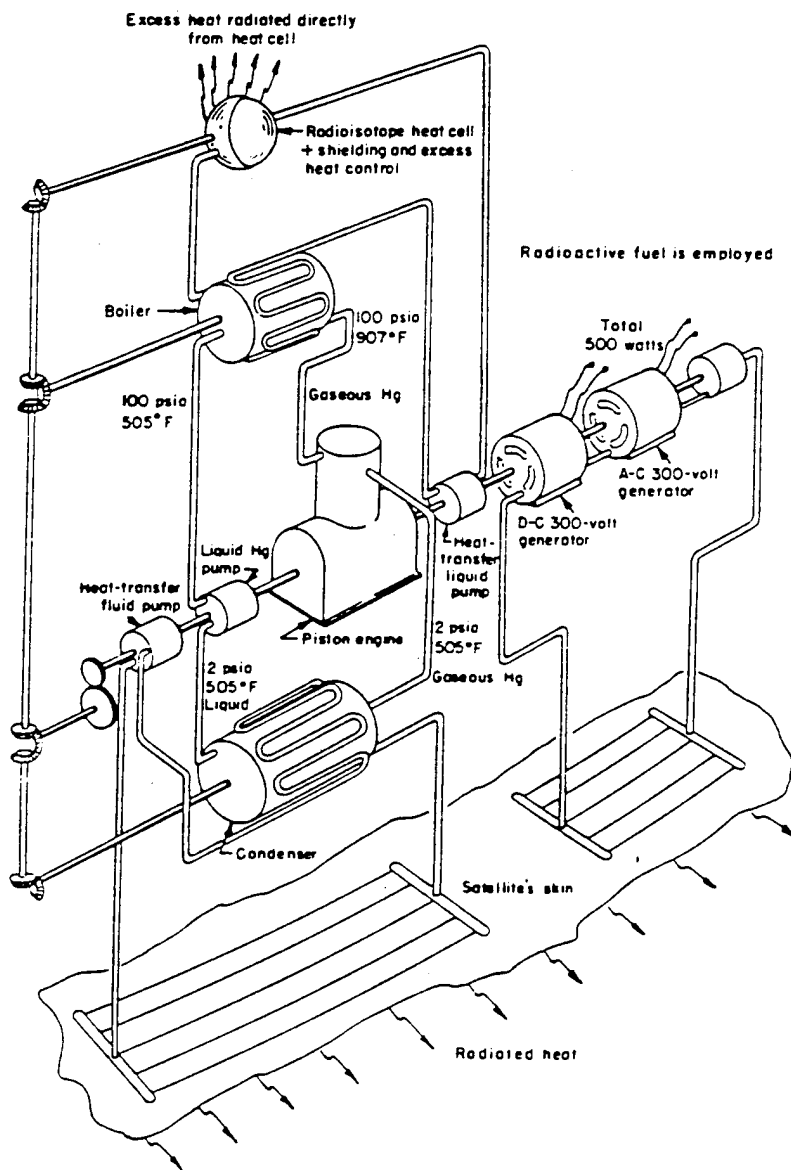

Fig. 27—Schematic diagram of vapor-cycle auxiliary powerplant for the satellite

auxiliary powerplant is a beta-emitting radioisotope. The reasons for such a choice will be discussed both here, where the selection of a beta emitter rather than an alpha or gamma emitter will be considered qualitatively, and in Appendix IV, where the problems which would arise from some fuel source other than a radioisotope are examined.

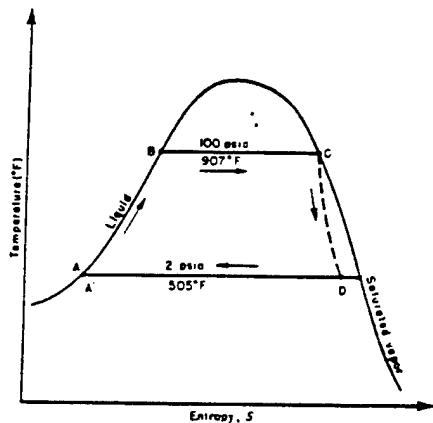

Fig. 28—Schematic diagram of temperature-entropy of mercury vapor cycle

**Alpha, Beta, and Gamma Rays.** Most of the radioactive particles to be anticipated from a radioisotope consist of electrons and positrons,\* alpha particles (helium ions), and gamma rays (high-energy X-rays).

Gamma rays are highly penetrating compared with alpha and beta particles. To obtain an adequate amount of heat energy by stopping gamma rays would require a large thickness of heavy material. Moreover, it is doubtful whether a high-enough temperature could be obtained for suitable operation of a heat engine of the satellite type, even if the attendant large shielding weight were acceptable. In fact, it is desirable that the particular isotope to be chosen for the satellite have a minimum of gamma-ray activity.

since gamma rays are highly toxic and are also detrimental to various materials and to the operation of electronic equipment.

Alpha particles are also toxic but are quite heavy in comparison to gamma and beta rays and can be stopped by a few centimeters of air. The main deterrent to the use of alpha particles is the lack of an adequate supply of a suitable alpha emitter<sup>(†)</sup> of the appropriate half life† which would also have a low gamma-ray activity. One such potential source is polonium 210, whose half life of 140 days indicates its possible suitability to the 40-day satellite period, but whose scarcity indicates a low probability of its being assigned to the satellite program.

The beta particles thus emerge as the most likely source of nuclear heat energy for the satellite. The beta rays themselves are not particularly toxic, but a secondary radiation, equivalent to gamma rays, arises from the deceleration of intense beta particles in the heat-producing shield. This effect, known as Bremsstrahlung, could be quite troublesome.

\* Referred to here as beta particles, although not all electrons or positrons given off by a substance can be strictly attributed to beta emission.

† Half life is an index for measuring the exponential decay and, simultaneously, the activity of a radioisotope. Any substance, radioactive or otherwise, whose activity results in a death (or birth) of one of the units of the substance, and which has a probability of such activity directly proportional to the remaining unchanged units of the substance, will then have an activity exponentially decreasing (or increasing) with time. Thus, if we let  $N$  represent the number of unchanged units (radioactive atoms called parent material) present at any given time,  $t$ , then the rate of extinction of parent material is  $dN/dt$ . Where  $\lambda$  is a constant depending on the substance and measuring its activity,  $dN/dt = -\lambda N$ . Solving for  $N$  yields:  $N = N_0 \exp(-\lambda t)$ , where  $N_0$  is the number of particles present when  $t = 0$ . If we find the time,  $T_{1/2}$ , at which  $N$  is  $1/2 N_0$ , i.e., the parent material is halved, we then obtain the half life of the substance. Since  $t = 0$  when  $N = N_0$ , and  $t = T_{1/2}$  when  $N = 1/2 N_0$ ,  $T_{1/2} = \log_2 2/\lambda = .693/\lambda$ . Either  $\lambda$  or  $T_{1/2}$  is then an index of the activity of the radioactive substance in question.

The relation of the half life of the nuclear heat source to the useful life of the satellite will be discussed later.

However, it is believed that temporary use of a tungsten shield during launching will reduce the health hazard to a safe level, and, further, that a moderate amount of shielding, coupled with proper design of the cell for the radioactive materials, can alleviate, for the most part, the effect of Bremsstrahlung upon the operation of the several electronic equipments, particularly the television tube.

**Beta-producing Radioisotopes.** There are several beta-producing radioisotopes to be considered for use in the satellite's auxiliary powerplant. Table 3 lists the pertinent characteristics of cerium 144, ruthenium 106, yttrium 91, and strontium 89. The first two,  $Ce^{144}$  and  $Ru^{106}$ , have half lives of the order of a year and are thus suitable for the long-duration satellite. Although any of the four could be satisfactory for a 30- to 40-day period of operation, it may be necessary and desirable to use either of the former two ( $Ce^{144}$  or  $Ru^{106}$ ), because any appreciable delay between separation and application of  $Yt^{91}$  or  $Sr^{89}$ , whose half lives are slightly less than 2 months, tends to degrade their activity advantage.

**Table 3**  
**SOME PERTINENT CHARACTERISTICS OF  $Ce^{144}$ ,  $Ru^{106}$ ,  $Yt^{91}$ , AND  $Sr^{89}$**

Isotope		Fission Yield* (%)	Half Life†	Types of Radiation†	Energy of Radiation (Mev)†	
					Beta Rays	Gamma Rays
$Ce^{144}$	Cerium	5.3	275 days	$\beta^-$ , $\epsilon$	0.348	none
$Pr^{144}$	Praseodymium	....	17 min	$\beta^-$ , $\gamma$ , $\epsilon$	3.07	0.135
$Nd^{144}$	Neodymium	....	Stable	.....	.....	.....
$Ru^{106}$	Ruthenium	0.48	1 year	$\beta^-$	0.03	none
$Rh^{106}$	Rhodium	....	30 sec	$\beta^-$ , $\gamma$	3.55 (82%)	1.25 (1%)
					2.30 (18%)	0.73 (17%)
						0.51 (17%)
$Pd^{106}$	Palladium	....	Stable	.....	.....	.....
$Yt^{91}$	Yttrium	5.9	57 days	$\beta^-$	1.53	none
$Pa^{91}$	Protactinium	....	Stable	.....	.....	.....
$Sr^{89}$	Strontium	4.6	53 days	$\beta^-$	1.5	none
$Yt^{89}$	Yttrium	....	Stable	.....	.....	.....

\* See Ref. 20.

† See Ref. 21.

It is believed that any of these four isotopes can be separated, without exorbitant cost, from existing nuclear pile wastes.  $Ce^{144}$  is preferred to  $Ru^{106}$ , since it is more than ten times as prevalent as a by-product in the manufacture of plutonium. In addition, it has a lower gamma activity than has  $Ru^{106}$ . On the other hand, military priority for  $Ce^{144}$  may necessitate use of  $Ru^{106}$ ; further, since more curies of  $Ce^{144}$  than of  $Ru^{106}$  are required, the heat (cal.) for the former will be somewhat larger than that for the latter.

Since radioactive decay does not depend on the specific configuration of the radioisotopes but is directly proportional to the amount of parent material present at any time,

a considerable degree of flexibility exists in the choice of the type of heat source. Most of the isotopes can be alloyed with high-melting-point metals for their use in the solid state; this form of heat source will be applied to the closed-cycle gas engine. With the vapor engine, the liquid state is preferred.

Inasmuch as radioisotopes decay with time, it is necessary to provide a means for disposing of the surplus heat energy during the initial period of their use. As an example, the employment of  $Ce^{144}$  for a year (its half life being 275 days) requires dissipating 1.51\* times the energy required by the engine. It is, of course, possible to allow the engine to accept a variable amount of heat over its lifetime. However, this means a larger engine and, consequently, a much larger heat disposal problem (by the cooler or the condenser) on the low-temperature end of the cycle. The specific design of the heat cell will be discussed next, where a description of a proposed means for providing a constant supply of heat to the engine is included.

### The Radioactive Heat-producing Cell

As an example, a radioactive heat-producing cell which employs the radioisotope  $Ce^{144}$  will be described. As was noted above, the cell should be designed to minimize the effects of primary and secondary (Bremsstrahlung) gamma radiation. Further, such a cell should be not only light in weight, but also capable of resisting the effects of high temperature and nuclear radiation for periods of a year or longer.

Cerium 144 is mixed with cerium 140, a stable isotope, for use in the molten form. This diluent was chosen in order to avoid possible chemical reactions with the radioisotope under the high temperature and the nuclear radiation exposure. Also, cerium has the proper melting point for use in the liquid state.

The cell is made in the form of a sphere (see Fig. 29) in order to minimize the amount of shielding required. To reduce external Bremsstrahlung, the cell case is made of beryllium, which produces very little secondary radiation. The thickness of the case, about 8.5 mm, is always larger than the maximum range of the 3-Mev beta particles in beryllium. The internal parts of the cell, such as the stirring paddle and the heat-exchanger tubes, are also made of beryllium. The paddle turns in the cell to agitate the molten cerium and prevent local hot spots.

The use of beryllium for the case material has advantages other than its absorption properties previously mentioned. Beryllium has a high conductivity which prevents hot spots on the covered portion of the cell; it also has a low density and can thereby provide a large radiating surface for a relatively small amount of weight.

The outer cell wall temperature is assumed to be 1300°F. This temperature is 1162°F below the melting point of the case and it is high enough so that, with the calculated drop in temperature through the case wall and with the stirring vane tending to equalize temperatures in the cerium, all of the cerium will remain molten. Also, there is suffi-

\* The dissipating rate required is determined by

$$\frac{275 \text{ days}}{365 \text{ days}} = \frac{\log_e 2\lambda}{\log_e (x+1)/\lambda} \quad x = \exp[.693(365/275)] - 1 = 1.51.$$

\* Various isotopes of a given element usually have very similar chemical properties.

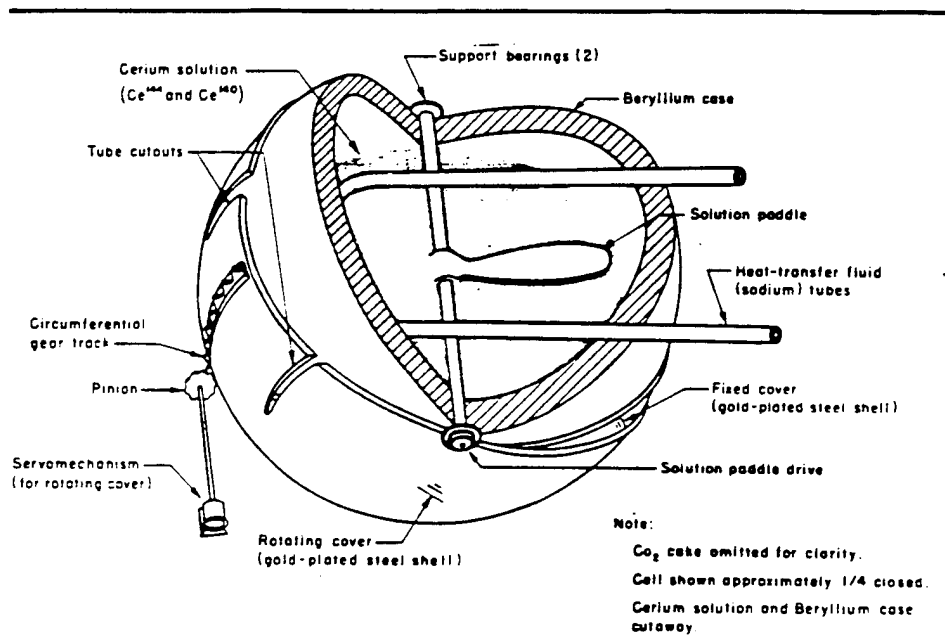

Fig. 29—Cerium cell with controlled-heat input to the heat-transfer fluid

cient temperature potential across the heat exchanger to maintain the mercury vapor in the boiler at 907°F.

To absorb the gamma rays due to the internal Bremsstrahlung, it is proposed that a portable tungsten shield surround the cell during the prelaunching checkouts for protection of the ground crew. This shield would need to be about 13 cm thick<sup>(11)</sup> and would weigh about 2500 lb. The shield could be removed from the satellite vehicle just prior to take-off by a remote control device; although the amount of gamma radiation would be harmful to the crew, it would not be strong enough to interfere with the electronic equipment in the vehicle.

To control the amount of heat transferred to the working fluid, the surplus of heat generated in the cell is thermally radiated into space from an exposed portion of the beryllium case. The amount of energy radiated to space is regulated by the opening and closing of overlapping hemispherical shells which have gold-plated surfaces to reflect most of the thermal radiation back into the cell (see Fig. 29). Gold plate is used since it is about the only material which maintains a low emissivity at a high temperature. One half-shell is fixed relative to the cell, while the other is rotated by a servo-driven gear, which is controlled by the voltage output of the electrical generator of the orbital powerplant.

For cooling the radioactive cell during the satellite-boosting trajectory, a cap of solid carbon dioxide is mounted adjacent to the open face of the radioactive cell. After stage separation, the carbon dioxide cap melts away and the cell is free to radiate into space, since the vehicle shell which surrounds the motor compartment of the final stage, where the orbital powerplant is located, separates with the initial stage (see Section VI).

---

### The Engine System and Its Components

The remaining components of the vapor powerplant will be discussed in the order of passage of heat from the heat cell.

**The Heat-transfer Vehicle.** Tubes, through which is coursing a heat-transfer fluid (sodium), are inserted in the heat cell. The sodium picks up heat energy at about 1200°F (the cell temperature being 1300°F) and is pumped through coils surrounding the mercury boiler, thus maintaining a sufficient temperature gradient to heat the mercury in the boiler to 907°F. Sodium appears to have desirable properties for this transfer operation: it is light in weight, has a high conductivity, and, since it has light atoms, reduces the Bremsstrahlung of the fluid.

**The Boiler.** As stated in the powerplant requirements and as indicated in Fig. 27, it is believed necessary to simulate the effect of gravity by continuously rotating the mercury boiler, thereby providing convection forces for separation of the liquids and gaseous phases of the working fluid. The liquid is fed along the inside of the periphery of the drum. The drum is rotated at a velocity such that the centrifugal force on the liquid becomes equivalent to gravitational forces. By convection, gaseous mercury is thus forced to the centerline of the drum where it is bled off in a pipe located at the axis of the drum.

**The Engine.** Mercury vapor is then passed into the power converter, a compound vapor-piston engine\* similar to a conventional reciprocating two-stage expansion steam engine. Difficulties to be anticipated in design of such an engine include developing suitable reliability (from wear-and-fatigue failure standpoints) for a year's unattended operation and coping with the "wetness" of the mercury vapor at the low end of the cycle. With regard to the latter, upon expansion of the mercury vapor through the engine, about 15 per cent of the mercury (by weight) condenses out in the form of liquid. This high moisture content would not be tolerable in a turbine, but unless slugs of liquid tend to collect in the cylinders of the piston engine, it is thought that this problem can be accommodated by the piston engine. The acquisition or development of a more suitable working fluid (one having the temperature-pressure characteristics of mercury, but having either no moisture or only a small amount of superheat at the end of expansion) would be indicated if moisture content is objectionable. Dowtherm† has properties similar to mercury but cannot be used in an engine in an efficient fashion since it has a high degree of superheat at the end of expansion.

One further difficulty that may be experienced in the engine is leakage of the working fluid past the pistons into the engine crankcase. However, considerable latitude will exist in the development of this component of the satellite's auxiliary powerplant, and scavenging will undoubtedly be possible.

**The Generator.** The mechanical power developed by the heat engine drives 300-volt d-c and a-c generators. It is believed desirable to employ a d-c generator (probably of the universal variety) in addition to an a-c induction generator, since if either type

\* The design of an efficient, lightweight turbine with a 50:1 pressure ratio and a mercury flow weight of around 1 lb/sec does not appear feasible.

† A mixture of diphenyl and diphenyl oxide.

---

were used separately, either rectification of part of the alternating current or a dynamotor conversion of part of the direct current would be required, with attendant losses in power. The d-c generator must have a commutator capable of withstanding constant operation over long periods. Arcing of the commutator will not be a problem in the rarefied atmosphere of the satellite unless some phenomenon such as vaporization of the generator lubricant occurs. If a semiperfect lubricant, such as lead sulfite or graphite, is used, with appropriate seals to prevent diffusion of small particles into the commutator section, then arcing will probably not be experienced.

Generator cooling—to the extent of 200 to 300 watts of heat developed because of generator inefficiencies—can be accomplished by circulating a heat-transfer fluid through capillary tubes located at appropriate points in the generator, which could be done easily if a number of other such systems are in use in the vehicle; otherwise, direct radiation from the generator to outer space can be utilized.

**The Condenser and Cooler.** To continue from the engine, the working fluid, mostly in the vapor phase, is passed into the condenser where it is liquefied. The condenser is virtually identical with the boiler. Its essential differences are that it is larger; that the heat-transfer fluid is NaK,\* which has a lower solidifying temperature and is therefore more appropriate than sodium for the low-temperature end of the cycle; and, of course, that the heat-transfer coils exterior to the rotating drum conduct heat out of rather than into the working fluid. The waste heat is taken out of the condenser at about 350°F, which allows more than ample gradient to transfer heat by means of capillary tubes into the satellite's skin. The satellite's skin then radiates the heat into space at a temperature of approximately 200°F. A more complete discussion of heat dissipation from the satellite's skin is contained in Appendix V.

The positive displacement pump, possibly a hardened-steel-roller variety, boosts the liquid mercury to 100 psia pressure and into the boiler, where the cycle is resumed.

#### **Operation of the Vapor Powerplant**

A considerable portion of the preceding description of the components of the vapor engine powerplant has presented various aspects of the operation of such a system. The following remarks are therefore supplementary to the foregoing.

Shortly before take-off of the vehicle, the removable tungsten shield is placed around the heat cell; and the radioactive cerium solution is pumped into the cell from a ground trailer equipped with the necessary shielding as well as a cooling system for removal of surplus heat from the tungsten shield prior to launching. At this time, the heat-cell reflector is in the wide-open position. The several positive displacement pumps are then started by mechanical power from a ground supply fed in through a power take-off from the various motor shafts. As the temperature and pressure of the mercury approach the design values, the compound piston engine begins operation. Shortly, the generator starts to supply the required power for operation of the satellite payload. At the last practical moment before flight, the tungsten shield and associated equipment are removed from the vehicle.

---

\* NaK is a eutectic mixture of 56 per cent sodium and 44 per cent potassium by weight.

During the ascent to the orbital altitude, the auxiliary powerplant energizes the payload continuously, as noted in Section II. As also previously stated, cooling during this period is accomplished by means of the carbon dioxide (Dry Ice) cake.

When the power output of the generator goes above or below certain limits, the generator output controller signals the servo-drive to open or close the reflector cover, as required. In this manner, not only are the covers gradually closed to keep the boiler temperature constant in the face of cerium 144 decay, but reasonable errors in predicting heat transfers and radioactivity will be automatically corrected. If for some reason it is found desirable to have varying generator power outputs, then the boiler temperature can be increased or decreased by moving the half-shell faster or slower than the decay rate, thereby changing the mercury vapor temperature. A thermocouple, installed in the boiler, overrides the generator output controller whenever the boiler temperature exceeds a safe value.

#### Vapor-System Weight Estimate

A summary weight estimate of the satellite's vapor-type auxiliary powerplant system is presented in Table 4.

**Table 4**  
**ESTIMATED WEIGHT OF 500-WATT VAPOR-CYCLE**  
**SATELLITE AUXILIARY POWERPLANT**

Component	Weight (lb)
Radioisotope and diluent.....	80
Heat cell less radioisotope.....	50
Boiler and heat-transfer system.....	30
Working fluid (mercury).....	50
Condenser and heat-transfer system.....	60
Mercury pump and motor drive.....	5
Piston engine.....	30
Electric generator.....	25
Miscellaneous fittings and brackets.....	30
Coolant for satellite ascent (Dry Ice).....	40
<b>TOTAL</b> .....	<b>400</b>

It is, of course, obvious that the total estimated system weight of 400 lb is in considerable excess of the 250-lb requirement. This 150-lb overweight would require a satellite of roughly 15 per cent higher over-all gross weight. Addition of a storage battery to the system, discussed in Appendix V relative to the gas-cycle powerplant but applicable as well to this one, is a possible approach to be considered in a weight-reduction program. Moreover, it is possible that ingenious design of each of the individual units may accomplish marked weight reductions for this type of auxiliary powerplant.



## THE CLOSED-CYCLE GAS ENGINE SYSTEM

The general arrangement of the gas engine powerplant, although similar in many respects to that of the vapor engine, is sufficiently different to warrant separate discussion of it as a system. The primary difference lies, of course, in the engine, which will be described here in some detail. Another distinction is the use of the beta-emitting radioisotope in solid rather than in liquid form. Such items as the generator, which is virtually identical in either system, will not be discussed further.

A schematic diagram of a closed-cycle gas engine system is presented in Fig. 30. The essential elements of this powerplant are: the solid radioactive heat source and its regulator, which provides heat for the working fluid in the hot zone of the engine; the gas engine (to be described) and electric generator, which change the heat energy into electricity; a heat sink in the form of a cooling jacket, which provides the necessary cold zone of the engine; and the associated heat exchangers, for both the heat source regulator and the heat sink, which carry the excess heat to the satellite's skin, where it is radiated into space.

A discussion of the gas engine will precede that of the heat source in order to establish the desirability of the solid-type fuel.

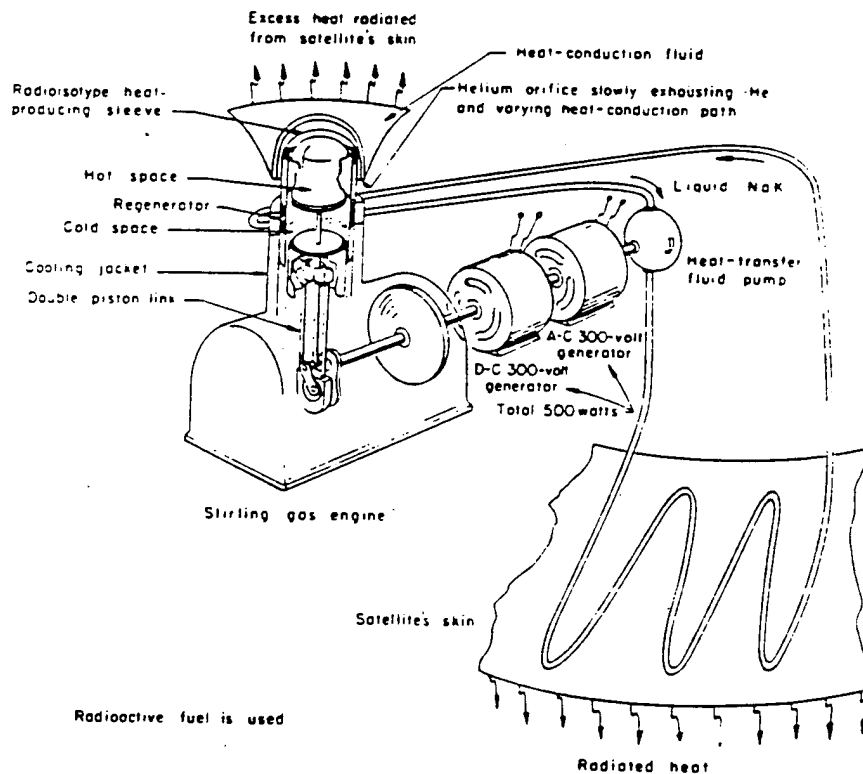

Fig. 30—Schematic diagram of gas-cycle auxiliary powerplant for the satellite

## The Gas Engine

As previously stated, a powerplant employing a working fluid that remains gaseous throughout the cycle is termed a gas engine. More commonly, this type of device is known as an air engine; but this implies that air is always used for the working fluid, whereas for satellite purposes an inert gas such as helium is proposed.

Gas engines are generally not as efficient as vapor engines because compression of the working fluid in the gaseous state requires an appreciable portion of the over-all engine output. Since it is desirable to use as efficient an operating cycle as possible, the Stirling cycle was chosen; even so, the gas engine uses about 25 per cent more heat input to produce the same amount of power as the vapor engine, and, furthermore, the heat dissipation from the low end of the cycle is a greater problem.

Note:

I-II and III-IV lines are isothermals. II-III and IV-I are isochorics. Thus the Stirling cycle has same efficiency as Carnot cycle, but with isochorics replacing adiabatic lines.

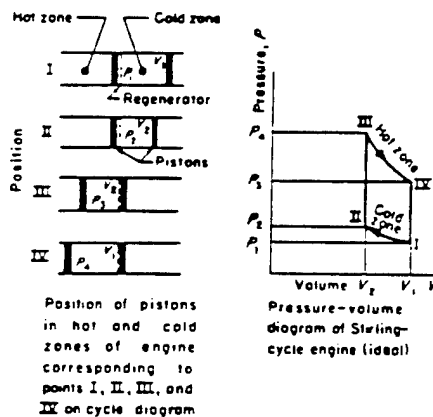

Fig. 31—Stirling-cycle pressure-volume diagram (related to motion of pistons in hot and cold zones)

The Philips air engine will be described to assist in visualizing the mechanism involved with a Stirling cycle. Figure 32 is a schematic diagram of the engine, and it indicates the operation of the pistons. The heat regenerator consists of metallic wool through which the working fluid passes between hot and cold zones; as the air passes through, it excites only the surface molecules. The air reversal is so rapid that hot and cold air alternate through the exchanger every  $\frac{1}{40}$  sec or less. Indeed, it is this intermittent flow principle that allows such a small device for heat exchange. If the same amount of heat exchange were attempted on a steady flow basis the size of exchanger required would be enormous.

References 22, 23, and 24 contain good descriptions of the Philips engine if further details are desired. Stirling engines more appropriate to the satellite's powerplant will

The Stirling cycle was first envisaged by a Scotch clergyman in the nineteenth century, but until the advent of recent development by the Philips Company, little was done to build an engine incorporating his principles. The basic cycle consists of an isothermal compression, a constant volume heating, an isothermal expansion, and a constant volume cooling (see Fig. 31). To approximate this cycle in an actual engine, it is necessary to have a cold zone and a hot zone in the cylinder wherein these isothermal changes can take place; further, it is very desirable to have a regenerative heat exchanger between the zones to aid in accomplishing the constant volume heating and cooling. The heat exchanger is the factor contributing most heavily toward the success of an engine of the Stirling-cycle type. In the past, air engines have been built without this device but have been notably poor in efficiency.

be considered at a later date; for the present, the analysis is based on the characteristics of the Philips engine because these data are readily available.

The over-all efficiency of the gas power-plant is about 7½ per cent when generator losses are included and about 12 per cent when they are excluded. In order to attain this degree of efficiency, it is necessary to operate the hot zone of the engine at around 1140°F and the cold zone at about 200°F.\* A 1200°F temperature is thus required of the heat source; by proper design of the engine's cooling system, a satellite's skin temperature of 160°F is adequate for disposing of waste heat from the low-temperature end of the cycle.

#### The Cooling System

The heat disposal problem is more critical in the gas engine than in the vapor engine because more heat, and at a lower temperature, must be carried away from the former. Liquid NaK is pumped through a finned housing which surrounds the cold zone of the engine, then through 400 ft of ¼-in.-ID capillary tubes which are laid alongside the interior of the satellite's skin. In order to increase the cross conduction of heat through the skin, i.e., transverse to the tubes, a 0.002-in. copper sheath is placed between the skin and the tubes. Production of 500 watts by the proposed gas engine necessitates radiation of about 20,000 Btu/hr, which, at a skin temperature of 160°F, requires about 100 ft² of the "earth side" of the satellite—actually 2½ per cent more than the entire bottom half of the presently envisaged 1000-lb payload vehicle. (See Appendix V for a more detailed analysis of the heat disposal problem).

#### The Heat Source

In order to have a compact heat source for the gas engine, it is proposed that the cerium 144 be alloyed with a suitable metal whose melting point exceeds 1200°F.

\* On the basis of the Carnot cycle, the ideal thermal efficiency of such a Stirling cycle is  $100(1600^{\circ}\text{R} - 660^{\circ}\text{R})/1600^{\circ}\text{R} = 58.7$  per cent; on the same basis, the vapor-cycle thermal efficiency is only 29.4 per cent. However, with estimated over-all efficiencies (excluding generator losses) of 12 per cent and 15 per cent, respectively, for the gas and vapor systems, it follows directly that the efficiency of the gas engine itself is only 20.5 per cent, while that of the vapor engine is about 51 per cent.

+ To reduce Bremsstrahlung tendencies.

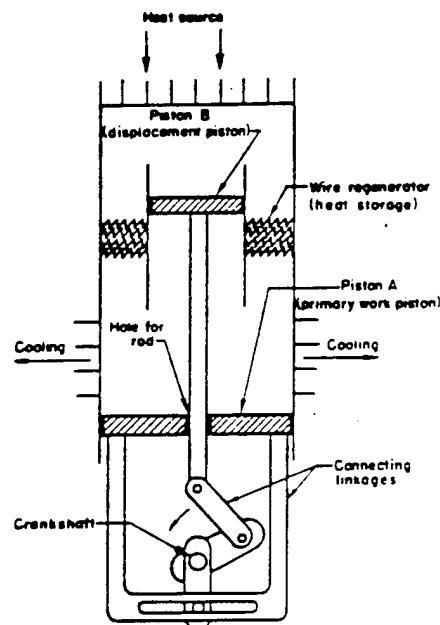

Fig. 32—Schematic diagram of a Philips' version of the Stirling engine

Beryllium is one such possibility, although it does not alloy too readily with cerium; other possibilities include magnesium, aluminum, and titanium. If a satisfactory alloy composition cannot be made, a sandwich constructed of a  $Ce^{144}$  center between layers of beryllium can be substituted. In either event, it is desirable to have as pure  $Ce^{144}$  as possible.

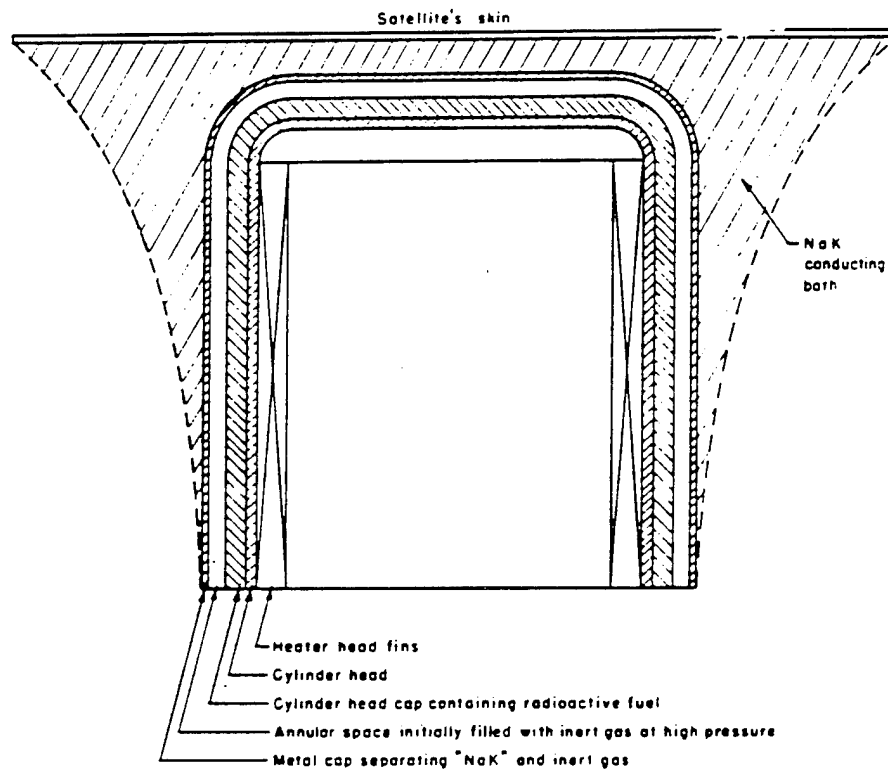

Fig. 33—Proposed heat-rejection scheme for solid-radioactive-fuel source

Postulating that such a cap of solid metal containing the radioactive fuel can be fabricated, the arrangement of the heat source around the hot zone of the engine is depicted schematically in Fig. 33. In order to furnish a nearly constant rate of heat to the engine, a heat-conductive path is provided directly from the fuel to the radiating surface of the vehicle skin.\* During the satellite's useful lifetime, the heat resistance of this path is increased in such a manner as to compensate for the exponentially decreasing rate of heat production by the radioisotope, thereby ensuring nearly constant fuel temperature. Such a scheme is indicated in Fig. 33, where a gap is shown between the fuel cap and the heat-transfer medium. This gap is originally filled with a high-pressure inert gas such as helium; during the designed life of the satellite, the gas is leaked out of the

\* The regulation system described here is more automatic than the one used in the vapor cycle. There is no prime reason for associating either regulation scheme with a particular cycle since the best sources are similar, e.g., the variable radiation shell could be used on the gas cycle.

gap through an orifice so that at the end of the period the heat flow across the gap is negligible, owing to the low heat conductivity of the remaining low-pressure gas—practically a vacuum. There are a number of possible variants to this scheme: using a semipermeable membrane instead of an orifice, using a slowly changing chemical or adsorption process, etc.

#### Operation of the Gas Engine System

With the primary exception of placing the solid-fuel cap over the hot end of the cylinder head by a remote-controlled mechanism rather than pumping the liquid radioisotope into a heat cell, the ground-starting and the subsequent operation of the gas powerplant are substantially similar to those of the vapor plant. Therefore, a detailed description of the operating characteristics of the gas system does not appear to be warranted.

#### Gas-System Weight Estimate

The estimated over-all weight of the gas-cycle powerplant is listed in Table 5.

**Table 5**  
**ESTIMATED WEIGHT OF 500-WATT GAS-CYCLE**  
**SATELLITE AUXILIARY POWERPLANT**

Component	Weight (lb)
Heat source, including radioisotope and transfer system for excess heat . . .	60
Engine . . . . .	100
Cooling system . . . . .	25
Generator . . . . .	25
Coolant while vehicle is in ascent. . . . .	40
TOTAL . . . . .	250

Philips engines built for nonaircraft application have exhibited bare engine weights of 0.3 lb/watt for approximately 175-watt output. For larger sizes, an improvement in weight is indicated; for example, a 500-watt, nonaircraft engine could be built for about 125 lb weight. Furthermore, by removing such items as the auxiliary starter, the main starting pad, etc., and by using light metals, it is probable that the entire engine, exclusive of heat source and cooler but including generator, could be built for this 125-lb figure.

#### SUMMARY

Two 500-watt powerplants, each using a beta-emitting radioisotope, have been considered; either of the vapor-cycle or gas-cycle systems presented appears to be feasible for use as a satellite auxiliary powerplant. However, the vapor-cycle engine was found to be the heavier—400 lb as compared with 250 lb—and may necessitate considerably greater attention to engineering details than will the gas-cycle engine. On the other hand,

---

the gas engine will require about 1 lb of radioactive fuel as compared with 0.8 lb for the vapor engine; if the radioisotope separation processes are very expensive, this may be an important consideration. Furthermore, waste heat disposal from the gas cycle requires a much larger portion of the satellite's skin—a total of approximately 100 ft<sup>2</sup>—to be used as a radiator than does the vapor cycle; the problems attendant on incorporation of a reliable cooling system over so large an area will have to be investigated more fully.

---

## V. RELIABILITY OF THE SATELLITE

One of the most important and difficult problems in the development of a successful satellite vehicle is the attainment of a high order of reliability in both the satellite components and the ground equipment. To achieve this reliability will require a serious and concentrated effort in research and development of reliable components as part of the satellite engineering program.

Present experience indicates that while reliable operation of the airframe, propulsion, auxiliary powerplant, optical systems, and associated mechanical parts requires serious study, the major part of the entire satellite reliability problem lies in the difficult task of developing reliable electronic components. Further, although the complex ground electronic equipment is an important aspect of the problem, the greatest challenge is in the achievement of electronic reliability in the satellite itself. There are at least three reasons for this. In the first place, the satellite equipment is unattended, so that ordinary maintenance to prevent failures, inspection to locate failures, and replacement to repair failures are all impossible. In the second place, the satellite equipment is subjected to the rigors of shock and vibration during the launching and flight of the vehicle. Finally, complete duplication of equipment by means of one or more complete stand-by systems is possible on the ground but not practical in the satellite. (Some duplication in the vehicle components will be possible and will be considered later.)

Since the most serious problem is the achievement of reliable satellite electronic equipment, the present section will emphasize this aspect of reliability. The requirements will be formulated more explicitly, and after a discussion of present electronic reliability, an attempt will be made to indicate the most promising directions of research. It is realized that only a segment of the satellite reliability problem is being considered, and this, in a preliminary and tentative fashion. However, it is the most important segment, and many of the general conclusions indicate a research and development philosophy which is applicable to the other phases not discussed.

### ELECTRONIC EQUIPMENT

The major electronic systems in the satellite are the television camera and related circuiting, the transmitter, the tracking receiver system, the attitude control, and the power supply controls. A total of 50 to 100 electronic tubes and a television tube are included in this equipment.

### OPERATING REQUIREMENTS

In order for the satellite to operate successfully, it is necessary for the unattended equipment to function properly and continuously for the satellite's flight period. Both the short period of 35 days (840 hr) and the long period of 1 yr (~ 8800 hr) will be considered.

---

It is important to note that the task of the electronic equipment—to function properly—sets definite limits on the various performance parameters (currents, voltages, etc.) of the circuits. Failure must be considered as occurring if any one of these performance parameters falls outside its task limits. This means that failure of the satellite will result not only from overt failure (e.g., outright breakage or shorts), but also from submarginal performance of the electronic equipment (e.g., moderate noise levels in the tubes), which under usual circumstances would result in undesirable but acceptable operation. This critical dependence on the submarginal performance of electronic components is in a large measure due to the critical high-performance operation which is demanded of the entire satellite-ground station electronic system. It is thus clear that the reliability of the satellite electronic equipment is intimately dependent on both the quality and stability of the components and also on the design governing their use in the circuits. These factors determine what may be called the *internal environment* of the circuits, i.e., the conditions at one circuit element which are due to the other circuit elements.

#### EXTERNAL ENVIRONMENT OF THE ELECTRONIC EQUIPMENT

In addition to the internal environment, the electronic reliability will also depend on the conditions outside the electronic equipment, the *external environment*. The most important external factors are the ambient temperature, humidity, and pressure conditions, and the shock, acceleration, and vibration conditions, which give rise to inertial forces.

Temperature is probably the most critical of these factors in affecting the stability and lifetime of the components, particularly tubes, resistors, and capacitors. In addition, most of the power consumed by the electronic equipment appears as heat from the heaters in the tubes, so that provision will have to be made to conduct away this heat, perhaps by circulating a coolant around the tubes. Humidity affects the lifetime of capacitors and resistors and is a factor in metallic corrosion. The effects of pressure are less certain but appear to be important in arcing and relay wear.

In view of the serious effects of these ambient conditions on the performance and lifetime of the electronic components, the following assumption will be made: *The electronic equipment in the satellite is housed in compartments in which the temperature, humidity, and pressure are controlled and held at nearly constant values which are optimum for electronic reliability.* Since these optimum values will depend on the design and character of future improved electronic components, it is not possible to state them at present, and one aim of the reliability research program (discussed below) should be to establish these optimum ambient conditions.

The dynamic factors of shock, acceleration, and vibration result in inertial forces which stress and distort parts of the electronic components. These forces may cause outright breakage or permanent distortion, thus affecting both the performance and stability of components as well as decreasing their lifetimes.

In the initial flight period (launching and preorbital flight), lasting about 2 min, axial accelerations are expected to be less than 10g, including both launching and staging separation. Transverse accelerations for control into the orbit will be less than 0.1g. It is also expected that no important vibration will occur and that only gradual accelerations will be applied so that no shocks are present.



---

In the orbital flight period, only small transverse accelerations less than 0.1g will be applied for attitude control purposes. Again, no vibrations or shocks are expected, except possibly for a very low frequency (50 cycle/sec) vibration from the powerplant. Finally, an unimportant, but novel feature of the environment of the electronic equipment in the orbital period lies in the complete absence of gravity.

It is thus seen that the equipment is expected to be subjected (1) to accelerations of the order of 10g in the initial period, (2) to occasional 0.1g accelerations in the orbital period, and (3) to negligible additional shocks and vibrations throughout the entire flight.

While (1) and (2) appear reasonable, condition (3) may be harder to realize, since resonant vibrations in the airframe will tend to be excited in the preorbital flight through the atmosphere. (Serious troubles of this nature are known to have been met in the V-2 development.) Despite such possible difficulties, however, the above estimates will be taken as realistic statements of the environmental conditions under which the satellite electronic equipment must operate.

#### STATEMENT OF RELIABILITY REQUIREMENTS

Having discussed the operational requirements and the environmental conditions, the reliability requirements for the electronic equipment can now be summarized. *It will be assumed that a 90 per cent probability of success is sufficient for the system, so that:*

The satellite electronic equipment must withstand accelerations of the order of 10g initially, after which it must operate properly for a flight time of either 840 or 8800 hr, with a cumulative probability of success of 90 per cent. During the entire flight time, the equipment will be subjected to small supplementary accelerations (less than 0.1g) and will be housed under the ambient temperature, pressure, and humidity conditions which are optimal for the electronic reliability. Vibration and shocks will be negligible.

The requirement of 90 per cent success leads immediately to what is probably the most stringent condition of all, the electron tube reliability. Ignoring everything except the tubes, it is seen that if  $p$  is the probability that one tube will operate successfully for the flight, then for 100 such tubes it is required that  $p^{100} = 0.9$ , or  $p = 0.999$ , so that the "allowable" failure probability of a single tube is  $q = 0.001$ , or 0.1 per cent. For 50 tubes,  $p = 0.998$  and  $q = 0.2$  per cent.\* The same order of magnitude of reliability is required for the resistors, capacitors, etc., which are roughly equally numerous. For the two or three extremely critical elements (such as the television tube), reliabilities of the order of 99 per cent are probably acceptable.

These requirements lead to the following questions:

How big is the gap between the reliability required of the satellite equipment and the reliability now available in present electronic equipment?

What is the character and cost (in dollars, skilled personnel, research facili-

---

\* The tubes are considered independent. This is an unproven but plausible assumption which should give the order of magnitude of  $q$ .

---

ties, and time) of the required research and development program for the satellite electronic reliability?

Present knowledge of reliability and electronic technology is inadequate to answer these questions in detail. A brief discussion of the problem is presented in the following sections.

### PRESENT VERSUS REQUIRED RELIABILITY

The heart of present-day electronic equipment is the electron tube. In general, tubes are less reliable individually than most other electronics components, and the large number of tubes used in most equipment makes the tubes collectively by far the most unreliable component. Thus it is a fact that for many types of electronic equipment under widely varying conditions and usage, about one-half to two-thirds of the equipment failures are electron tube failures. There are notable exceptions to this statement, particularly in cases where attention has been paid to reliability in the design and maintenance of the equipment. Nevertheless, it is clear that improved electron tube reliability will be a major factor in achieving the satellite requirements. For this reason, and also because most present data concern tubes, attention in this section will be concentrated on the question of tube reliability: How reliable are tubes now and how can they be made more reliable?

First, so far as the acceleration of 10g in the initial period is concerned, two effects will occur: (1) There will be a fraction of outright tube failures, caused by breakage, deformation, etc., which prevents the tube from functioning at all. (2) the acceleration will change the tube characteristics and stability and thus will shorten the lifetime during which it functions properly. In present tubes, most failures of type (1) are mechanical failures caused by poor tube-quality control in manufacture. It appears to be a matter of experience that these failures can be greatly reduced by good design and quality control. Present-day superior tubes must survive service tests including accelerations of 500g for 45 ms, as well as extensive vibration tests. A relatively high fraction (about 95 per cent) operate within their task limits after this brutal testing. For the relatively mild satellite acceleration, it is believed that the failure rate would be less than 1 per cent for present high-quality tubes, such as those developed by RCA (red tubes), by Aeronautical Radio Incorporated, or by the Navy under its Tube Ruggedization Program. If the satellite failure probability in the initial period is to be of the order of, say, 1 per cent for the 100 tubes or 0.01 per cent for individual tubes, then it appears that under 10g accelerations the best modern tubes have an individual failure probability of the order of 100 times that required in the satellite.

The tubes which survive the initial period and begin to function properly will suffer failures during the flight which depend on effect (2), i.e., the "weakening" of the tube by the initial 10g acceleration. In addition, the small 0.1g control accelerations will affect the tube life, though perhaps to a negligible extent. In this phase of the flight, lasting 840 hr (or 8800 hr), the requirement is that the cumulative probability of failure builds up to not more than about 10 per cent.

Neglecting the possible weakening effects and the small control accelerations, the long

---

orbital flight period under the assumed well-controlled ambient conditions can be compared with a favorable laboratory or industrial environment using the best design and quality control. Two such examples are given below:

*Bell Telephone Equipment Data.* Bell Telephone Laboratories<sup>(25)(26)</sup> have made extensive efforts to develop reliable tubes for use in communication and have achieved mean lives of the order of 100,000 hr (10 years) for several tube types. A remarkably low failure rate is recorded for some 6000 tubes in 230 bays of 12-channel carrier telephone equipment, operating 24 hr a day, 7 days a week. By careful tube testing once every 3 months, incipient failures were detected and the defective tubes replaced, the removal rate being about 1.5 per cent. The results showed that over a period of at least a year, not a single failure occurred in the 6000 tubes during the 3-month periods of unattended operation following the checks.

*Electronic Computer Experience.* Experience with the Whirlwind computer<sup>(27)</sup> indicates that for operating periods of 3000 and 13,000 hr, about 90 per cent of the tube failures were caused by changing characteristics (60 per cent) and mechanical defects (30 per cent), with the remaining 10 per cent attributed to heater burnout and gas within the tubes. For a typical computer having about 5000 tubes with a 5000-hr mean life, one failure per hour would be expected, and it is obviously necessary to lower this failure rate. A system of periodic "marginal checking" at frequent periods was introduced to remove incipient failures, and a preburning test was employed to remove tubes whose characteristics were changing too fast. These checks to eliminate defective tubes, together with good circuit design (large safety factors) and proper use of the tubes, have reduced the failure rate to about 5 per cent of that to be expected on a purely statistical basis. With such selected tubes, failure rates of about 1 per cent in the first 1000 hr and 30 per cent in the first 10,000 hr resulted.

At the other environmental extreme from laboratory conditions, one may consider electronic reliability in aircraft. Acceleration, shock, and vibration as well as temperature and pressure effects all combine to produce a rigorous environment for electron tubes. In military aircraft, the reliability is further lowered by inferior design and maintenance, and at present the highest electronic reliability in aircraft is realized in commercial planes:

*Aeronautical Radio Incorporated (Arinc) Experience.*<sup>(28)(29)</sup> Arinc, a nonprofit company formed by the commercial airlines to improve air-borne electronic equipment, co-operates with both the airlines and the tube manufacturers to locate tube defects and improve them. At present the tube failure rate, under standard maintenance procedures, has been reduced to 2.5 per cent in the first 1000 hr. This is a significant improvement in reliability, and it has been effected largely by reducing mechanical failures and faulty assembly by means of minor design changes and improved quality control. Ten improved tubes of various types have been developed and made available under the program.

## CONCLUSIONS

From these examples, it is seen that the Bell Telephone tube reliability of *less than one failure per 6000 unattended tubes in 3 months* far exceeds the reliability demanded of the short-period satellite (one failure or less per 100 tubes in 1000 hr). No data are

---

given on failure rates for periods longer than 3 months, so that no direct comparison can be made with the long-period satellite. However, using the above data, it is shown in Appendix VI that with a confidence of 95 per cent, the failure rate is less than 1 in 6000 for a 3-month operating period. From this fact and plausible physical assumptions about the failure characteristics of the tubes, a rough calculation (given in the same appendix) leads to a figure of about 70 per cent for the probability of no failure in the 1-year satellite (with 100 tubes). If these assumptions are justified, this result would appear to indicate (at least so far as the tube lifetimes are concerned) that even the rigorous long-term satellite requirements are near the forefront of the best modern electronic technology.

This important conclusion is strengthened by the fact that the Bell Telephone Laboratories have developed at least one other type of electronic equipment with extremely high reliability requirements, namely, the electronic repeaters in submarine telephone cable.<sup>(30)</sup> No data are yet available on the reliability actually achieved in this equipment, but the whole program has been geared to develop a system which will operate unattended for a period of 10 to 20 years. A further feature of interest to the satellite problem lies in the fact that the equipment suffers rather rough shocks when the cable is laid, after which it lies quietly on the ocean floor. Thus the repeater equipment would appear to be analogous to the satellite equipment insofar as both must survive a rigorous initial environment and then survive unattended in a very mild environment for a long period.

On the other hand, the electronic computer and Arinc results indicate a tube failure rate considerably higher than that demanded of the satellite tubes. Considering all the factors, it seems fair to say that the Bell Telephone experience indicates that the reliability for the 1-month satellite *can* be achieved, while the electronic computer and Arinc data show that the best present tubes fall far short of this high reliability. The reliability in the 1-year satellite is certainly a more difficult problem; little can be said except that it, too, can probably be achieved with greater effort, using techniques of the type employed in developing the submarine cable equipment.

In general, similar conclusions seem reasonable regarding the electronic components other than tubes. Paralleling the tube programs mentioned above, a variety of research efforts are at present directed toward improved electronic components with longer life and more stable operating characteristics. These efforts include studies of printed circuits, of miniaturized components, and of the packaging of electronic equipment.

#### RELIABILITY RESEARCH PROGRAM

Since it appears reasonable that the required satellite reliability *can* be achieved, the next question is, *How* can electronic reliability be improved to the required degree? The obvious answers are (1) by improved components, (2) by improved circuit design, and (3) by inspection, selection, and pre-use testing to eliminate defective components. Present component-improvement programs provide a wealth of technical data on these matters. It is clear, however, that while considerations (2) and (3) are important, (1) is really the crux of the matter. The problem of achieving long life in electronic components is more formidable than that of ruggedization against the relatively mild

---

10g accelerations expected. It is generally conceded that adequate knowledge on the subject of long life is lacking and has to be increased before really substantial progress can be made; on the other hand, components which are designed specifically for long life can show great improvements over standard production items.

In addition to improved components, it is necessary, as has been pointed out, that improved electronic design studies be carried through. These may include unconventional techniques, such as providing parallel or duplicate systems as stand-bys in case of failure. The use of several components to carry the load may increase the life of the system many times (e.g., by use of several tubes in place of one to cut down cathode depletion). And, finally, a *uniform* advance of electronic methods and components is necessary to ensure a balance of reliability throughout the system, so that as far as possible there will be no relatively very weak links which jeopardize the entire operation. This is particularly vital for the satellite, which requires a high reliability for the television tube and similar major components, which are few in number, as well as for the numerous minor components, such as tubes, resistors, and capacitors.

#### SUMMARY

The reliable operation of a satellite vehicle poses difficult but by no means unsolvable technical problems. The most difficult part of the reliability problem resides in the development of superior quality electronic equipment which must withstand initial accelerations and then operate properly for the remainder of the flight period. Although the reliability of most standard electronic equipment is at present far below the satellite requirements, it appears that the best modern electronic telephone equipment has a reliability at least as high as the 35-day satellite requires. To achieve a high reliability throughout the 1-year satellite, a research and development program on electronic components will be required, together with a careful study of designs and techniques for using these improved components.

## VI. THE VEHICLE

The preceding sections have discussed the problems of utility of an orbiting satellite, particularly as a reconnaissance device. The purpose of this section is to present a description of the vehicle and to re-examine the problems attendant on establishing the satellite on an orbit. This analysis will be brief, because the results of the study reported in Refs. 3 through 14 are generally applicable and, further, because the principal emphasis of RAND's work since those reports has been concerned with the utility of the vehicle in the orbit rather than with the vehicle itself.

The vehicle characteristics are considered in the following order: flight mechanics, aerodynamics, heat transfer, propulsion, and structural design. The techniques employed were developed as a result of the earlier satellite studies, referenced above, as well as during the recently reported long-range surface-to-surface rocket and ramjet missiles study.<sup>(31-35)</sup>

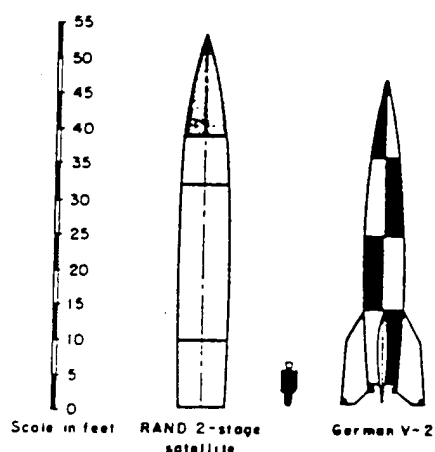

Fig. 34—Size comparison of satellite vs V-2

component weights as they will likely exist in 1954, (3) a payload weight of 1000 lb, and (4) an orbital altitude of 350 mi. Variations in payload weights from 300 to 2000 lb and in orbital altitudes from 350 to 600 mi are also considered.

As a result of RAND's continuing work concerning rocket vehicles generally and, more specifically, the improved state of the arts regarding component and over-all missile design, the current configuration of the satellite vehicle differs somewhat from that previously reported. It is, of course, reasonable to expect that as the state of the art improves, such advances will be applied to satellite as well as missile designs.

The satellite vehicle as presently envisaged consists of a two-stage, hydrazine-liquid-oxygen-propelled rocket vehicle, whose launching size is moderately larger than the V-2 (see Fig. 34). This configuration is based on (1) present-day construction materials and manufacturing techniques, (2)

### PREORBITAL-FLIGHT-MECHANICS CONSIDERATIONS

A general procedure for analyses of the satellite vehicle consists, first, in consideration of the flight mechanics governing the preorbital, or ascent, phase of flight and secondly, in determination of  $v$  (mass ratio) values required to place a given payload weight at a specified orbital altitude.

For equatorial orbits, which will be of continuing interest for experimental satellite vehicles, the equations of motion for the ascending rocket are essentially the same as those described in Ref. 3. As will be discussed below, however, oblique orbits of interest for reconnaissance require modification of the equations.

The difference in vehicle performance between equatorial and oblique trajectories is considered to be negligible during the relatively short (4½ min) burning period, during which time the vehicle's reference system is associated with the moving earth. However, when the motion is considered to be transferred to an inertial (space) frame of reference, as it must be at some time during the trajectory (arbitrarily selected here, for convenience, at the end of burning), there is a significant difference between the oblique and equatorial cases.

The change in vehicle velocity as measured in the inertial (space) system rather than in the moving (earth) system is approximately equal to the projection on the orbital plane of the earth's velocity component,  $\omega_E r$ , due to its rotation, where  $\omega_E$  is the angular velocity of the earth and  $r$  is the distance from the satellite to the center of the earth. This velocity shift can be either positive or negative, depending on the direction of launching: if the satellite is launched eastward, the increment is positive and thus adds to the satellite's speed. For the equatorial case, the magnitude of the velocity change is  $\Delta V \cong \omega_E r$ , as stated; for the oblique case, however,  $\Delta V \cong \omega_E r \cos L$ , where  $L$  is the angle of obliquity between the orbital plane and the earth's equator.

Using the equations and techniques of Ref. 3, modified as indicated above, together with the aerodynamic, heat transfer, powerplant, and weight data presented in the

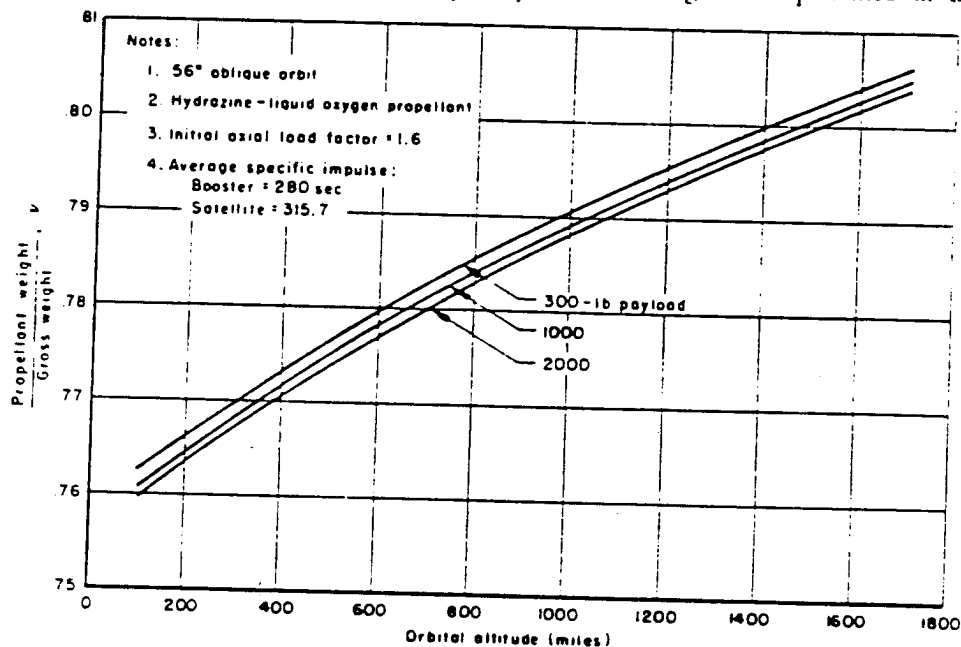

Fig. 35—Initial propellant weight to initial gross weight ratio,  $v$ , as a function of orbital altitude for varying payload weights

following portions of this section, it is then possible to determine  $v$ , the ratio of initial propellant weight to initial gross weight, as a function of various payload weights and orbital altitudes as shown in Fig. 35. The cases illustrated by Fig. 35 are for a  $56^\circ$  oblique orbit; the propellant is hydrazine-liquid oxygen.

As stated previously, the complete preorbital trajectory for a 1000-lb payload, 350-mi-altitude satellite consists of about 2 min of booster-powered ascent and of approximately  $2\frac{1}{2}$  min of second-stage powered ascent, followed by a 20-min coasting period to the orbital altitude where power is applied momentarily to provide the final boost into the proper orbit. Altitude and velocity as functions of time are shown in Fig. 36 for the principal power-on portion of flight for the stated case.

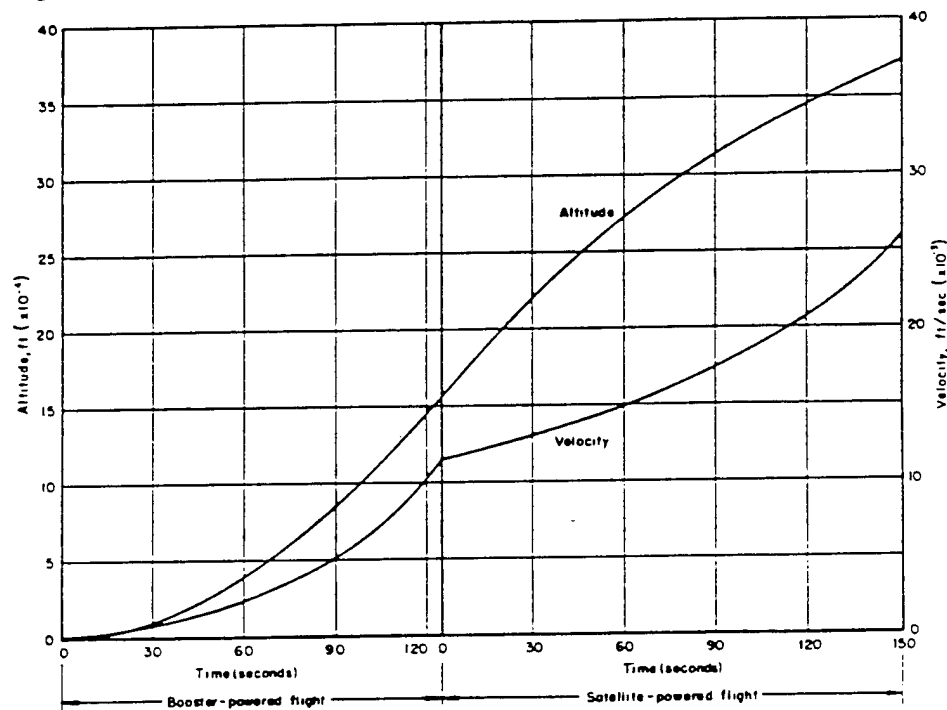

Fig. 36—Flight trajectory for the principal power-on (precoasting) portion of a 1000-lb-payload, 350-mi-orbital-altitude satellite

## AERODYNAMICS

The aerodynamic characteristics of the present satellite rocket are determined by using the methods put forth in Ref. 36, with a few notable modifications. First, the temperatures of the boundary layer used in determining skin friction are lower because they are based on the more recent data of Ref. 37, rather than those of Ref. 38; the lower temperatures result in higher values of skin friction coefficient. Secondly, in the prior work,<sup>(36)</sup> the pressure forces on the nose were determined by substituting an



equivalent cone for the actual ogive; this substitution remains unchanged in the present analysis for the low and moderate Mach number regimes. At hypersonic velocities ( $M = 10$  or above), however, the pressures on the ogive are determined for the actual ogive shape according to Case 5 of Ref. 39. Thirdly, a change concerns the assumption of the drag due to boattailing. The present case is calculated on the basis of the data presented in Fig. 37; these curves are a modification of Fig. 5 of Ref. 36 but are based on more recent test data.

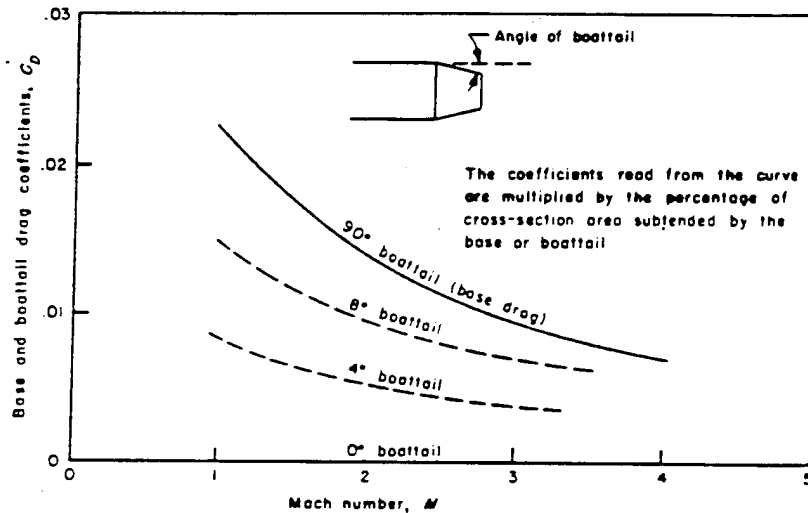

Fig. 37—Base and boattail drag coefficients

### HEAT TRANSFER

As mentioned above, the temperatures influencing aerodynamic variables are based on the methods developed in Ref. 37. These temperatures, of course, prevail only where atmosphere exists and are dependent on the rate of acceleration of the vehicle as well as on the magnitude of velocity. Thus there is a compromise between allowable load factor of the vehicle and the temperatures experienced by the vehicle's skin, which is discussed briefly under "Structural Design," page 75.

In the orbit, temperatures are dependent only on the net influx of radiational heat. Once the vehicle passes out of the significant atmosphere, it begins to cool to those temperatures consistent with the orbiting conditions. Figure 38 illustrates the over-all temperature variation of the satellite; the derivation of a similar curve for the previous satellite work is discussed in Ref. 40.

### PROPULSION

None of the satellite propulsion components differ materially from those presently being tested for guided missiles. In fact, the thrust of the individual motors is considerably less than that of the V-2. The first (booster) stage has four gimbal-mounted,

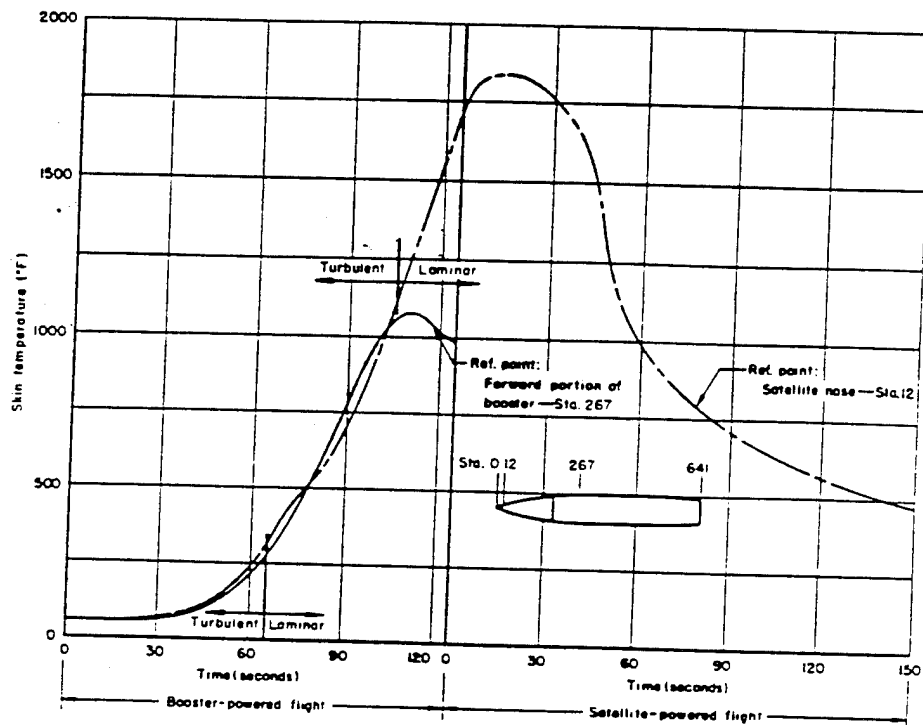

Fig. 38—Skin temperatures during powered flight for a 1000-lb-payload, 350-mi-orbital-altitude satellite

equal-thrust rocket motors which are used for both propulsion and control; in the 1000-lb-payload, 350-mi-orbital-altitude case, their combined thrust is 117,750 lb. (An individual rocket motor of 75,000-lb thrust has been fired recently.) In the second stage, a single 15,500-lb thrust motor is used for propulsion only; four small rocket motors, each having about 1 per cent of the total thrust, provide the necessary trajectory control during and at the end of the coasting period.

The proposed design uses hydrazine-liquid oxygen as the propellant. Since emphasis throughout this study has been centered on currently available materials, components, and techniques, the use of hydrazine may be questioned by the reader. It is true that hydrazine is available now in small amounts only, and at relatively high cost. However, a recent study<sup>(11)</sup> by The Ralph M. Parsons Company indicates that larger pilot plants, capable of producing sufficient hydrazine for several satellite vehicles, could be built in the near future to market the fuel for less than 50 cents/lb.

In addition to hydrazine-oxygen, there are of course a number of propellants which could be used in a satellite rocket vehicle; for example, the readily available, inexpensive gasoline-oxygen combination could be used for comparable payloads and altitudes at no more than approximately twice the hydrazine-oxygen gross weight and structural cost.

## STRUCTURAL DESIGN

The over-all vehicle configuration (see Fig. 39) is an ogive-cylinder-boattail combination, with attachment of the two stages at the aft end of the second-stage propellant tanks. The covering of the second-stage powerplant compartment serves to transmit the axial acceleration loads during boost, is integral with the booster, and is carried away at the staging separation. The orbiting satellite configuration is also shown in the figure.

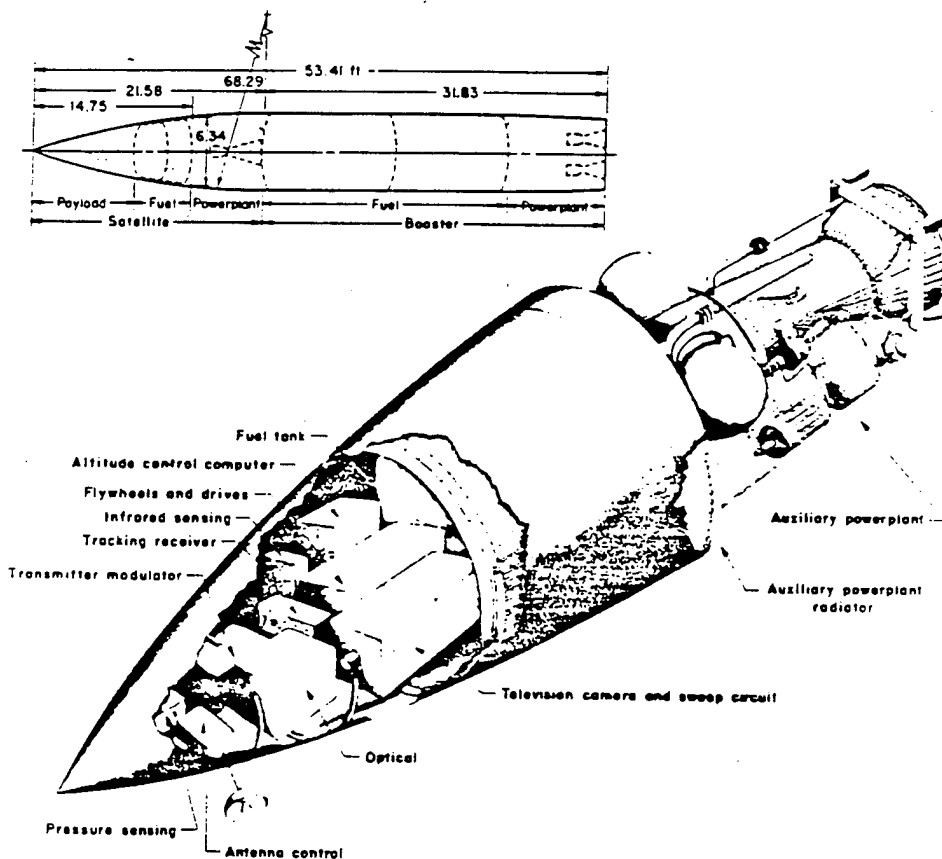

Fig. 39—Schematic diagram of a 1000-lb-payload, 350-mi-orbital-altitude, hydrazine-oxygen satellite vehicle

Loading experienced by the vehicle results principally from the axial accelerations during boost. Further, the structure is designed to resist the compressive loading at the temperatures shown in Fig. 38, which dictates that a heat-resistant alloy is required for some portion of the satellite's nose, where a material such as Hastelloy C sheet should be used; the remainder of the vehicle can be made of suitable steel, such as stainless steel. The indicated booster temperature and load requirements probably can be met by using titanium alloys; however, stainless steel is presently preferred because of the

---

advanced state of knowledge concerning its fabrication and because of its availability.

Conventional semimonocoque construction is employed throughout both satellite and booster. The fuel tanks and structure, except the previously mentioned Hastelloy C nose tip, consist of columbium-stabilized, 1/2-hard, 18-8 stainless-steel sheets, hat-section stringers, and frames. The booster stage has integral, pressurized tanks; the second-stage tanks are also pressurized but are nonintegral. The material for the motor mounts and related fittings is chrome-moly steel.

The optimum structural combination<sup>(24)</sup> of sheet and stiffening elements is determined by considering the combined effects of allowable panel compressive stress, buckling instability, and distribution of structural material. The average thickness of the structural element thus derived depends on the magnitude of the load applied to the structure, the environmental condition under which the structure operates, and the load-carrying ability of the material. Weight of structure may be found by integrating the thickness as a function of the surface area of the vehicle and then multiplying this volume of the structural material by its specific weight.

The satellite surface has an ogive shape whose total surface area may be expressed as an integral of the rate of change of the radius of the ogive. The value of the surface area is computed by integrating over the length of the ogive. The total length is determined by the volume and the body diameter required for the satellite payload, the quantity of propellant required by the vehicle, and the length of the powerplant section. Volumes for the 350-, 1000-, and 2000-lb satellite payloads are 35, 60, and 80 ft<sup>3</sup>, respectively. The body diameter of the payload compartment is believed more than ample to house the television camera-transmitter and attitude-control equipments. Propellant quantity required is determined from the ratio of initial propellant weight to initial gross weight,  $v$ , given by the flight trajectory (see Fig. 35), the propellant density, and the ullage, outage, and evaporation losses.<sup>(22)</sup> The equations for the length of the powerplant compartment are developed in Ref. 33.

The motor-mount structure, powerplant, plumbing, and auxiliary equipment weights also are determined in a manner similar to that of Ref. 33. As previously stated, component performance and weights are those which may be expected in 1954.

The control-system weight,  $W'_c$ , however, is empirically determined from existing and proposed missiles and, for the vehicle-gross-weight regime considered in this study, may be expressed as  $W'_c = 48 + 0.008063W'$ , where  $W'$  is the initial stage weight.

The procedure noted above for determining the vehicle's structural weight provides the optimum, or "ideal," load-carrying sheet-stiffener combination. To furnish the additional structural weight necessitated by access doors, nonoptimum-sheet-thickness gauges, as well as handling and fabrication requirements, a miscellaneous structure allowance of 20 per cent based on total vehicle structure is included.

As a check on the validity of the above type of analysis for evaluating structural weight, it is of interest to compare the structural weight to gross weight ratio thus determined with that of an existing missile. The Glenn L. Martin Company's Viking, a high-altitude sounding rocket, has a gross weight comparable to that of the 1000-lb payload, 350-mi-altitude orbital (two-stage) satellite. The satellite's fuselage, tanks,

and motor mount total 590 lb as compared with 673 lb for the similar items of the Viking missile.<sup>(42)</sup> This results in a structural weight to gross weight ratio of 0.061 for the satellite and of 0.068 for the Viking. It should be noted that the satellite's rocket-motor-compartment covering is an integral part of the booster and is carried away at booster separation, hence its weight is not included in the above satellite ratio.

The integral pressurized-type structure employed in the satellite booster is similar to the tank section of North American Aviation's Navaho missile. Extensive physical testing at the N.A.A. Aerophysics Laboratory of pressurized, full-scale, 70-in.-diameter, 0.020-gauge, welded 18-8 stainless steel ( $\frac{1}{2}$  hard), tank-type structure in both the stiffened and unstiffened condition has been conducted, and the structure possessed adequate margins of safety at all the design conditions.<sup>(43)(44)</sup> New techniques were developed to overcome the structural and manufacturing problems encountered. As an example, joints made by seam welding and mash welding result in uniform characteristics approaching the strength allowables of the parent metal, even in the  $\frac{1}{2}$ -hard condition.<sup>(45)</sup> The satellite's booster-tank structure, in order to resist the compressive loading resulting from the vehicle axial acceleration, is designed of plates of varying thickness with 0.020 established as the minimum sheet gauge. Internal stiffeners are provided to accommodate handling, transportation, and erection loads.

The satellite's booster-rocket-motor weight is that expected by 1954. North American Aviation's current effort on their 75,000-lb-thrust motor for the XLR43NA-1 propulsion system is being devoted to the development and production of a light-weight tubular motor. Preliminary estimates<sup>(46)</sup> indicate the expected thrust/motor weight ratio to be approximately 200. The booster motor weights calculated for the satellite missiles exhibit thrust/motor weight ratios of approximately 180.

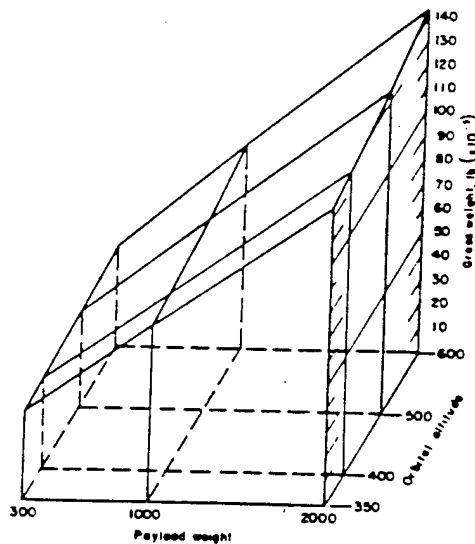

Fig. 40—Total vehicle gross weight as a function of payload weight for varying orbital altitudes

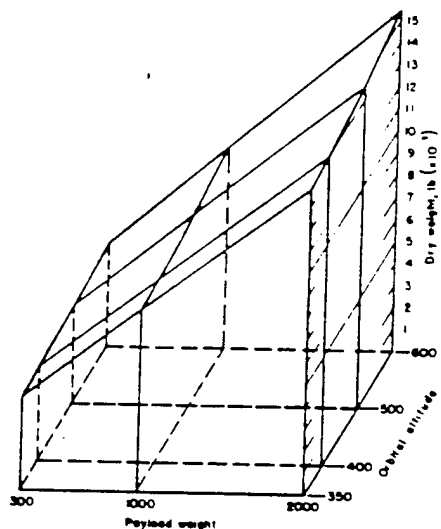

Fig. 41—Total vehicle dry weight as a function of payload weight for varying orbital altitudes

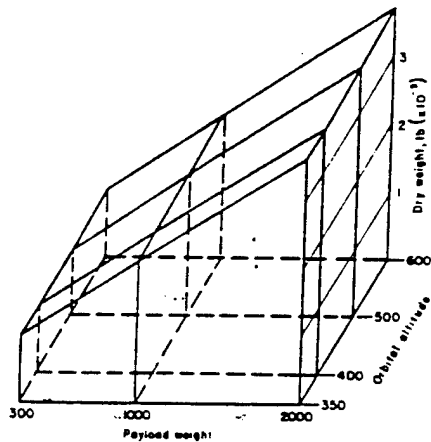

Fig. 42—Satellite dry weight as a function of payload weight for varying orbital altitudes

Total vehicle gross weight and dry weight and satellite dry weight are shown in Figs. 40, 41, and 42, respectively, as functions of payload weight for various orbital altitudes. It is of interest to note that, in the regime of payload weights and orbital altitudes considered, the variation of gross weight is virtually linear with respect to these variables. For a 350-mi orbital altitude, an increase in payload weight from 1000 to 2000 lb results in a gross-weight increase from 73,600 to 125,000 lb. Figure 40 also shows that if the 1000-lb payload is placed on a 500-mi-high orbit, a vehicle of 79,500-lb gross weight is required.

#### SUMMARY

Table 6 is a weight summary for a 1000-lb-payload, 350-mi-orbital-altitude satellite vehicle, which is boosted to altitude by hydrazine-liquid-oxygen-propelled rocket motors. As stated above, this vehicle's take-off weight is approximately 73,600 lb and, as shown in Fig. 39, its length is 53½ ft. The initial gross weight of the second stage is 9700 lb, and the vehicle is 21½ ft long. The orbital weight of the satellite is approximately 2200 lb.

**Table 6**  
**WEIGHT BREAKDOWN FOR A 1000-LB-PAYLOAD, 350-MI-ORBITAL-  
 ALTITUDE, HYDRAZINE-OXYGEN SATELLITE VEHICLE**

	Weight (lb)	Weight (lb)
<b>Satellite Stage (Final)</b>		
Payload		
Attitude control .....	280	} ..... 1,000
Television equipment .....	300	
Auxiliary powerplant .....	270	
Miscellaneous .....	150	
Structure		
Shell .....	175	} ..... 540
Stiffeners and frames .....	85	
Propellant tanks .....	280	
Controls .....		125
Motors .....		145
Motor mount .....		50
Turbopump and accessories .....		180
Plumbing .....		40
Propellants .....		7,615
Total .....		9,695
<b>Booster Stage (Initial)</b>		
Payload (Satellite stage) .....		9,695
Structure		
Booster-satellite fairing .....	200	} ..... 1,435
Propellant tanks .....	925	
Boattail .....	310	
Controls .....		640
Motors .....		665
Motor mounts .....		390
Turbopump and accessories .....		775
Plumbing .....		410
Miscellaneous (includes staging separation) .....		1,765
Propellants .....		57,785
Total Launching Weight .....		73,560
Total Dry Weight .....		8,160

---

## VII. CONCLUSIONS

The various components constituting a satellite vehicle to be utilized for reconnaissance have been shown to be individually feasible to various degrees. To combine these parts into a reliable operating whole will require considerable basic scientific and engineering effort. No radically new developments are indicated, however; rather, a reconstitution of known theory and art in rocketry, electronics, engines, and nuclear physics.

More specifically it has been found that a two-stage rocket vehicle weighing about 74,000 lb and carrying a 1000-lb payload of television, powerplant, and control equipment will be capable, at the least, of conducting weather and pioneer terrestrial reconnaissance, i.e., with a resolvable surface dimension of about 200 ft. The reliability with which this operation is carried out will depend mainly on the state of refinement of the electronic equipment. The reliability will determine, to a major extent, the time duration of the useful activity of satellite reconnaissance. Beyond a period of a few days, the over-all size and payload requirements of the satellite vary only by a small amount; a satellite designed for a year's operation will be little different from one designed for two weeks' useful life.

To increase the utility of the reconnaissance satellite will require improvement of television equipment to a state already attained under laboratory conditions. Should such be the case, it is believed that minimum resolvable surface dimensions of the order of 100 ft can be provided with continuous coverage over most of the USSR every day (over the entire target system every other day); also that these dimensions can be further reduced (at the expense of daily coverage) to values as low as 40 ft, complete coverage being attained after no more than a month's operation. With resolvable dimensions of this magnitude, a large portion of useful military reconnaissance can be accommodated by the satellite vehicle during periods in which weather permits ground observations.



---

## APPENDIX I

### EFFECT OF SCANNING ANGLE AND ORBITAL INCLINATION UPON MINIMUM RESOLVABLE SURFACE DIMENSION

The purpose of this appendix is to extend the discussions in Sections I and II, which are concerned with the general constraints imposed by orbital and television considerations, respectively, upon the utility of the satellite as a reconnaissance device.

For example, it is intuitively clear that for a given viewing angle, the width of the visible strip on the earth increases with altitude. However, the resulting effects upon focal length, frame frequency, pass bandwidth, signal-to-noise ratio, etc. (see also Appendix II), are not so readily apparent.

To continue with a summation of several of the more interesting effects of increasing the orbital altitude, the maximum number of possible views per day of a point target also increases, as does the average inclination of the line of sight between the satellite and the target (straight down being zero inclination). However, it is probable that the width of scanned strip on the ground will be determined by considerations of frame frequency, tube resolution, etc., and thus the width will be virtually fixed regardless of altitude. In this case, the average inclination will decrease, rather than increase, with increasing altitude.

#### ASSUMPTIONS AND LIMITATIONS

Although it will eventually be necessary to determine the optimum value of the several parameters in order to obtain the maximum information per day, no study has been made to determine the sensitivity of the "resolving power" of the over-all system to these various factors. A complete analysis would include a study similar to this one, wherein scanning angle is the principal variable, not only for a variety of orbital heights, but also for a variety of orbital inclinations to the equator, as a function of target latitude. In the work discussed thus far, both of the latter items were held fixed.

The optical system considered here is an Image Orthicon camera lens of 2-in. aperture and 20-in. focal length; these values are selected (from data in Appendix II) so that at contrasts of about 20 per cent and in sunlight,\* the minimum resolvable surface dimensions will be small enough to yield useful information. A graded filter will be included as an iris to control the photocathode illumination.

The following are assumed values for the parameters held constant:

The orbital altitude is 350 mi;

The optical system is an  $f/10$ , 2-in. aperture, 20-in. focal length camera;

---

\* Attention is confined to scenes viewed during the day for the reasons given in Appendix II (e.g., see Table 14, page 105).

The target latitude circle is held tangent to the southern edge of the most northerly portion of the scanning area (see Fig. 43).

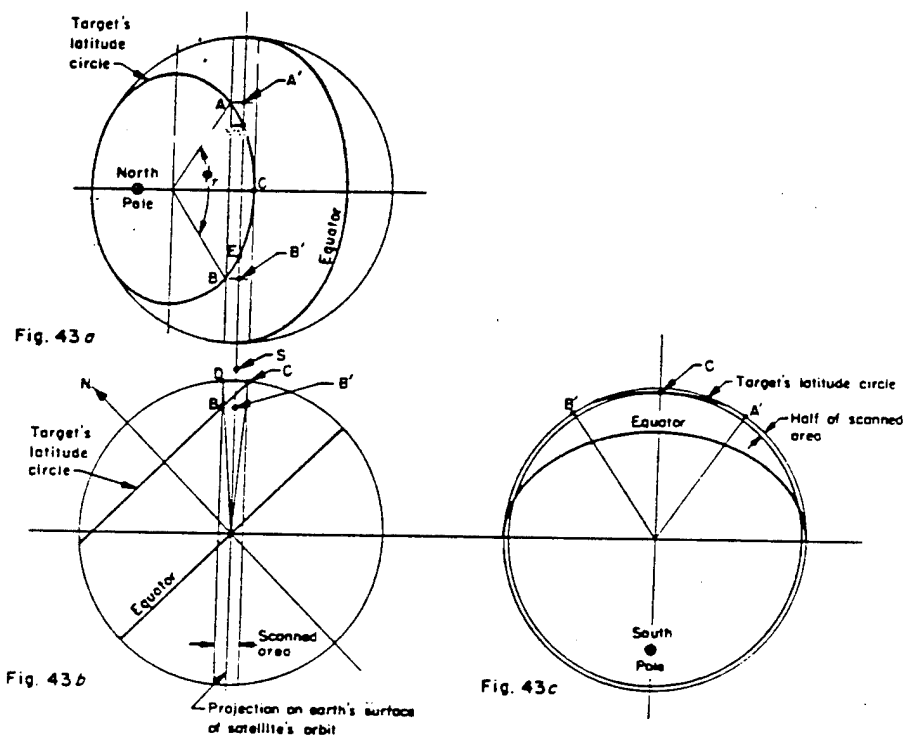

Fig. 43—Orthographic projection of the satellite's orbit relative to a viewed strip on the earth

### OBSERVED AREA AND SCANNING

On an orbit 350 mi above the surface of the earth and with a 20-in. focal length, the 1-in. square (photocathode) will cover, in a single picture, a square on the ground only 17.5 mi on a side; in making a complete revolution around the earth, it would result in an observed region that would be a strip 17.5 mi wide. This seems to be a very narrow band, and the temptation to introduce the complication of an optical-scanning mechanism is great enough to warrant consideration of what gain could result from the use of such a mechanism. It is conceivable that the inclusion of a scanning mechanism could increase tenfold or twentyfold the number of times the target would be seen. If such should be the case, the decrease in reliability and the increase in weight, within limits of course, would be more than worth while; by careful design, the power consumption increment could be kept negligibly small.

If the target were a point and the observed strip were a line, and if the satellite passed over the target once it would never do so again unless the period of revolution of the satellite were integral with the period of rotation of the earth relative to the

satellite's orbital plane. If the target is on the equator and the satellite pursues an equatorial orbit, then the target would be observed at each pass. This would also be the case if the target is one of the poles and the orbital plane is perpendicular to the equator. However, if the target is at some intermediate latitude, say  $55^{\circ} 45' 20''$  N.,\* then the percentage of the total number of passes during which the target is visible will be a function of, among other things, the width of the observed strip. The nature of this dependence, if expressed in an analytical form that would tell *exactly* the number of revolutions during which the target would be visible for any finite number of successive revolutions, is rather complicated. However, the percentage of successful "passes," as the number of revolutions increases indefinitely, will approach a constant that can be evaluated largely by the geometrical considerations, which will be amply accurate at this stage of the investigation.

### SCANNING ANGLE AND TARGET OBSERVATIONS PER DAY

For the present purpose, the plane of the orbit can be considered as being invariable, i.e., as having no motion other than translation; also, the motion of the earth around the sun can be disregarded. In Figs. 43a and 43b, this plane is seen edge on; Fig. 43c is seen perpendicular to the orbital plane—a standard orthographic projection. The scanning mechanism is assumed to operate so that successive pictures will be ordered (in the longitudinal direction) by a constant increment of distance. This is done for two reasons: first, the mechanism will be simpler, since scanning in one coordinate is accomplished generally by the satellite's motion; secondly, everything that comes into the field of view is seen when it is at its minimum distance from the vehicle (see Fig. 44). Obviously, the more of the target's latitude circle that lies within the area scanned by the satellite, the more frequently the target will be seen, and it is with this in mind that Fig. 43 has been drawn with the locus of the target's position tangent to the far edge (in the diagram, the southern edge) of the scanned area. The target "enters" the scanned region at B and leaves at A. When the satellite is in a position to see the target at B, its position is B'; similarly, the satellite's position is at A' when viewing the target at A. In Fig. 43b, point S is the position (to scale) the satellite would have on a 350-mile altitude orbit. The fraction of a total revolution that the target spends within the strip is  $\phi_T/2\pi$ , where  $\phi_T$  is the angle subtended by the arc ACB as seen from the center of the target's latitude circle. This fraction is the probability, at any time picked at random, that the target will be within the scanned region. If  $\phi_T/2\pi = 0.25$ , then the target will be in the scanned region for a quarter of a day at a time, during which time the satellite will make a little over 4 revolutions. During the subsequent 18 hr, about 12 revolutions of the satellite, the target will be invisible, and then the cycle will be repeated.

\* Latitude of Moscow.

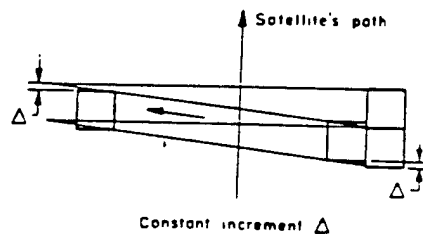

Fig. 44—Motion of optical scanning relative to satellite's path

---

The expression given for the average number of observations per day has been plotted in Fig. 45 as a function of maximum scanning angle (measured from the vehicle's vertical) for an orbital altitude of 350 mi and a target latitude of  $55^{\circ} 45'$ . It is of course assumed that the period is one during which the target is seen during the daylight hours.

If this relationship were the only criterion, the choice of scanning angle and inclination of the orbit to the equator would be a scanning angle of  $66.75^{\circ}$  (out to the satellite's horizon) and an orbital inclination of  $79^{\circ}$ , which give the maximum average number of observations (8.77) per day. A little reflection will show, however, that at this orientation the average inclination of the target surface to the line of sight (or, what is the same thing, the zenith distance of the satellite as seen from the target) and the average slant range might be undesirably large. Finding the true mean values of these quantities as a function of scanning angle requires a rather involved computation and graphical integration and adds very little to the following more elementary considerations.

#### SCANNING ANGLE AND MINIMUM RESOLVABLE SURFACE DIMENSION

In this discussion, what is meant by minimum resolvable surface dimension,  $\delta$ , is the linear separation of two objects at the target when it is just possible to see that they are distinct and not a single object. When the scanning angle is large (hence large slant range),  $\delta$  will be different for two points at the same range if the line joining one pair of points is parallel to the satellite's motion and the line joining the second pair is perpendicular to the satellite's motion. For the latter,  $\delta$  will be the smaller, which of course is the result of foreshortening due to the inclination of the target plane to the line of sight. The manner in which  $\delta$  (actually plotted it is  $\delta_0 \delta^{-1}$ ), in the parallel and perpendicular directions to the satellite's motion, varies with the scanning angle is shown by Fig. 46, curves 1 and 2, respectively. Curve 1 assumes simply that  $\delta$  varies in proportion to the slant range; curve 2 is obtained by multiplying the values of curve 1 by the secant of the associated zenith distance of the satellite as seen from the target.

Referring again to Fig. 43a, when the satellite is observing the target at small scanning angles, the target is in the neighborhood of the intersection points E of the target's locus and the great circle joining points A' and B'. Large scanning angles, of course, occur when the target is seen near the edge of the scanned region, as at A, B, and C. Since the target's locus is tangent to the edge of the scanned region, the target will be seen at large angles of scan more frequently than at small ones. Hence the mean value of the scanning angle at which the target is seen will be larger than half the maximum, probably about 0.6 of the maximum value. By using this rather qualitative information, it is possible to do some guided guessing. It does not seem wise to go to scanning angles so large that  $\delta$  increases to twice the value it has when the target is vertically below the satellite. In Fig. 46, the arithmetic mean of curves 2 and 3 has a value of about 0.5 at a  $50^{\circ}$  scanning angle. Since the horizon comes into view at  $66.75^{\circ}$ , and 60 per cent of this is only  $40^{\circ}$ , this criterion alone would indicate that scanning should be carried to at least  $40^{\circ}$ . Referring to Fig. 45, the number of observations per

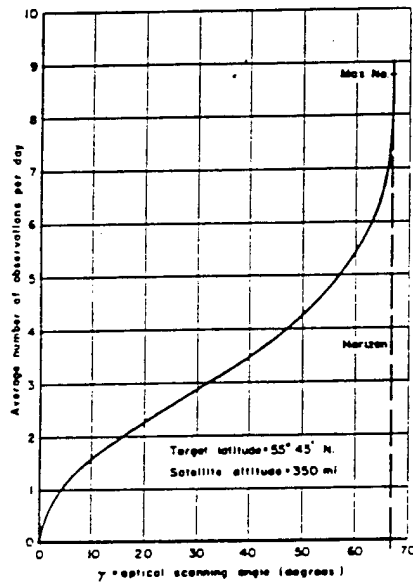

Fig. 45—Average number of observations per day vs maximum scanning angle

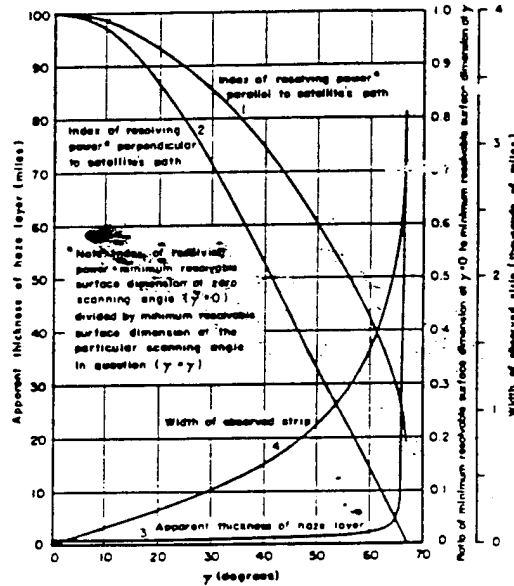

Fig. 46—Scanning angle,  $\gamma$ , vs apparent thickness of haze layer, index of resolving power perpendicular and parallel to the satellite's path, and width of observed strip

day increases so rapidly in this region that the temptation to carry the scanning to the limit is strong.

### SCANNING ANGLE, ATMOSPHERIC HAZE, AND PICTURE FREQUENCY

However, there are two more factors to be considered: the atmospheric haze and the number of pictures to be transmitted each second.

*Atmospheric haze* affects the resolving power by reducing the contrast in the scene; contrast is independent of range except insofar as the atmosphere scatters light into the optical system. The haze layer of the atmosphere, which produces most of the scattered white light, varies in thickness from 3000 to 5000 ft. The existence of this layer seems to be due to turbulence in the surface air carrying suspended matter, moisture and dust, up from the ground. This layer is densest at the ground level, naturally, and the meteorological service furnishes many year-round observations of the visibility at the surface at points well scattered over the United States. From these observations it is found that the visibility is between 7 and 12 mi about 80 per cent of the time. Hence, when the scanning angle is large, and if the optical system's line of sight passes through 5 mi or more of this haze layer, the scene contrast will be considerably reduced, but with a consequent increase in size of the minimum resolvable detail. Curve 3 in Fig. 46 was computed

on the assumption that the haze layer was 4000 ft thick and of uniform transparency; it shows that no appreciable loss of detail is to be expected out to scanning angles of about  $65^\circ$ . This conclusion is borne out by an examination of the pictures taken from the A-4 at an altitude of 100 mi. The disappearance of all surface detail near the horizon is so sudden that when scanning across the picture, the horizon seems to have been reached  $1^\circ$  or  $2^\circ$  before it actually has. However, if the subject being observed is the cloud formations (in the vicinity of the target), which usually occur above the 5000-ft level, the haze layer will present no observation difficulties. Consequently, if the satellite is to be a meteorological observatory, scanning should be carried to the horizon, and the orbit oriented so that the target's latitude circle is tangent to the southern edge of the observable region.

Curve 4 of Fig. 46 is a plot of the width of the observed strip as a function of the scanning angle for the 350-mi-orbital-altitude case.

Fortunately, the resolving power of the TV camera is not too sensitive to variations in picture frequency, at least not in the range of values from 10 to 30 frames/sec which will be required according to the analysis in Appendix II.

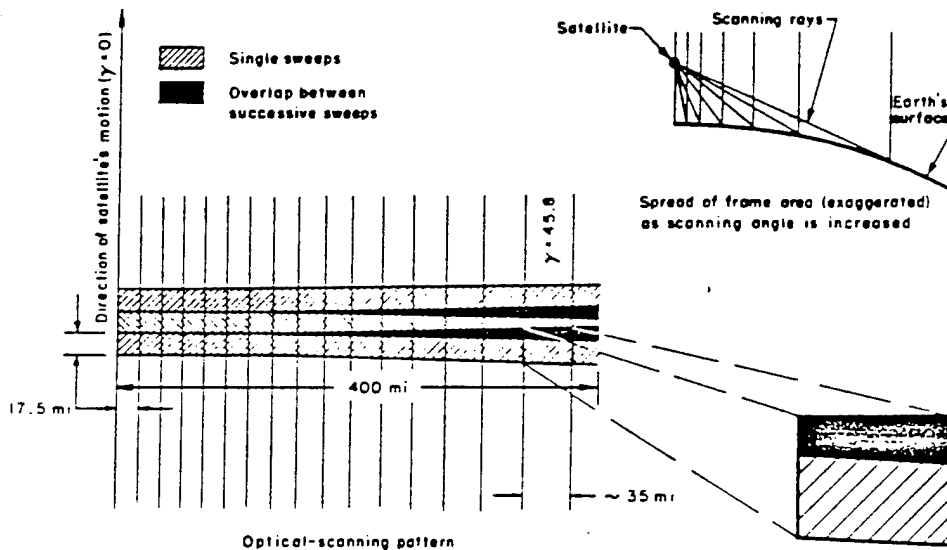

Fig. 47—Viewed pattern resulting from proposed optical-scanning system

Figure 47 shows to scale the pattern on the ground that the proposed method of scanning would produce. In this figure, three successive half-scans are shown, from directly below the satellite out to a scanning angle of about  $46^\circ$ . The line on the left of the diagram is the locus of the point that is vertically below the satellite. The vertical lines parallel to this are each  $2.87^\circ$  apart (the angular field of the television camera) as seen from the satellite, and therefore the space between them is the extent of one picture. The scanning is so timed that there is complete coverage with no overlap below

---

the vehicle; consequently, the scanned strips overlap (see blackened portions) in the direction of the satellite's motion at the large scanning angles. It is thus clear how the required number of pictures per second is determined. The total angular scan divided by the angle subtended by one picture gives the number of pictures in each strip, which must be taken in the time required for the satellite to move the width of one strip at its narrowest place, i.e., 17.5 mi, or 4.39 sec. Scanning to the horizon, therefore, would require about 11.5 pictures per second; for the 20-in. focal length, this is the maximum required under any circumstances.

\* \* \*

It is highly desirable to find some kind of "information index" by which means the proper choice of the parameters of this problem could be made and thus eliminate the need for any engineering judgment. Since any pickup device has an ultimate resolving power as a property of the surface on which the image is formed, the area of this "ultimate spot" divided into the total area of the image surface gives the number of separate pieces of information that can be contained in one picture. Or, the area covered by the image of the target divided by the area of the ultimate spot is a measure of the number of separate bits of information received from the target. The area of the image divided by the square of the focal length of the camera optical system is the solid angle subtended by the target; at present writing, this seems to be one of the quantities whose mean value is to be optimized. Certainly another equally important item is the average number of views of the target per day. The product of these two quantities could be the sought-for information index. The detailed optimization then would consist of computing these two numbers as a function of maximum scanning angle, orbital height, camera lens focal length, and a variety of other parameters such as orbital inclination and target latitude.

---

## APPENDIX II

### TELEVISION CAMERA AND COMMUNICATION DESIGN CONSIDERATIONS

This appendix presents more detailed analyses of the design considerations pertinent to the television camera-transmitter-receiver system necessary for satisfactory reconnaissance from the satellite.

#### TELEVISION CAMERA

##### Smallest Resolvable Surface Object

Although the possibility of telephoto reconnaissance from a satellite in an orbit 200 to 500 mi above the surface of the earth is attractive for several reasons, the limitations imposed by the height and speed of this vehicle upon the quality of the television pictures obtained from it should be appreciated at the outset. Given adequate optical, transmitting, receiving and recording equipment, the effective resolution of the television system will approach that of the television camera or pickup tube. The size of the smallest resolvable surface object is then determined by a simple geometrical relation:

$$\delta = \frac{1.056 \times 10^4 b}{nF} = \frac{1.056 \times 10^4 b}{n' \frac{F}{u}}, \quad (3)$$

- where  $\delta$  = smallest resolvable surface dimension, ft  
 $b$  = height of the satellite, statute mi  
 $F$  = focal length of the television camera, in.  
 $u$  = width of the pickup tube phototarget, in.  
 $n$  = resolution of the pickup tube, TV line/in.  
 $n'$  = resolution of the pickup tube, TV lines/frame.

The maximum resolution attainable under favorable operating conditions with the best available pickup tubes is of the order of 500 to 1500 TV lines/in. (or 500 to 2000 TV lines/frame); the maximum usable value of the ratio  $F/u$  is of the order 20 to 100, depending on the time constant of the pickup tube and the surface coverage per revolution required; the mean orbital height under consideration is 350 mi. It follows that the size of the smallest surface object resolvable by satellite television will lie in the range of about 25 to 370 ft, with 125 ft a probable representative minimum value.

The foregoing estimate of the order of magnitude of the minimum surface dimension resolvable in a picture obtained by satellite television may be taken as the present absolute minimum. It will be approached only under operating conditions such that the



over-all resolution of the system approximates that of the camera tube, and then only under conditions of scene brightness, contrast, and exposure time such that the effective resolution of the pickup tube approximates its maximum or "limiting" value. It can be significantly reduced only by substantial sacrifice in surface coverage or by major improvement in the design of television pickup tubes.

Equation (3) applies strictly to surface objects lying directly below the satellite orbit only; for objects so located as to subtend an angle  $\theta$  with the downward vertical at the satellite at the instant of exposure,  $\delta$  will be increased by a factor roughly equal to secant  $\theta$  (neglecting the earth's curvature). But since the maximum angle of obliquity at which useful pictures may be obtained is probably less than one radian, this correction involves a less than twofold increase in the minimum resolvable dimension.

#### Limiting Resolution of Pickup Tubes

The limiting or maximum resolution of a pickup tube, discussed more fully in the body of the report and noted here in the interest of continuity, is the upper limit imposed by the finite size of the scanning beam or of the individual elements composing the photosensitive target. The best present pickup tubes (Image Orthicons and Vidicons) have limiting resolutions of the order of 1500 TV lines/in. of photosensitive target surface under favorable and well-controlled operating conditions. It is probable that the limiting resolution of such a camera tube in unattended operation in the satellite will be substantially less, of the order of 500 to 1000 TV lines/in.

#### Effective Resolution of Pickup Tubes

The effective resolution of the camera tube may be less than its limiting resolution and will approach the latter as an upper limit only under favorable conditions of scene contrast, photocathode illumination, and exposure time. Dr. A. Rose of the RCA Laboratories has shown<sup>(47)</sup> that the high-light performance of any visual device, whether a television pickup tube, a photographic film, or the human eye, may be described in terms of a general equation:

$$BC^2\beta^2 = \frac{5 \times 10^{-3}k^2}{a^2t\theta} \quad (4)$$

in which  $B$  = high-light scene brightness, ft-L

$C$  = scene contrast, percent

$\beta$  = angle subtended by the smallest resolvable picture element at the optical center of the camera lens, min of arc

$k$  = threshold signal-to-noise ratio

$a$  = diameter of the effective aperture of the camera, in.

$t$  = exposure or storage time, sec

$\theta$  = quantum efficiency of the pickup tube photoprocess, i.e., the fraction of the incident quanta usefully absorbed in the device.

The threshold signal-to-noise ratio has been found to have a minimum value of about

$\theta$  at a maximum scene contrast of 100 per cent and to vary inversely with the contrast according to the approximate relation

$$k = \frac{500}{C} \quad (5)$$

The angle  $\beta$  may be expressed in terms of resolution in TV lines/in. by the relation

$$\beta = \frac{57.3 \times 60}{naf} \quad (6)$$

where  $f$  denotes the ratio  $(F/a)$ , or focal length divided by effective aperture. In pickup tubes of the full-storage type, such as Image Orthicons and Vidicons, in which light quanta arriving throughout the scanning period are usefully employed in the photo-process, the exposure time is simply the frame time or the reciprocal of the number of frames per second. With the indicated substitutions, Eq. (4) reduces to

$$n \doteq 10^2 C^2 \sqrt{\frac{\theta(B/f^2)}{N}} \quad (7)$$

in which  $n$  = effective resolution (high-light portions of picture),  
TV lines/in.

$N$  = frame frequency/sec

$B/f^2$  = incident illumination on the pickup tube photocathode (neglecting lens losses), lumens/ft<sup>2</sup>.

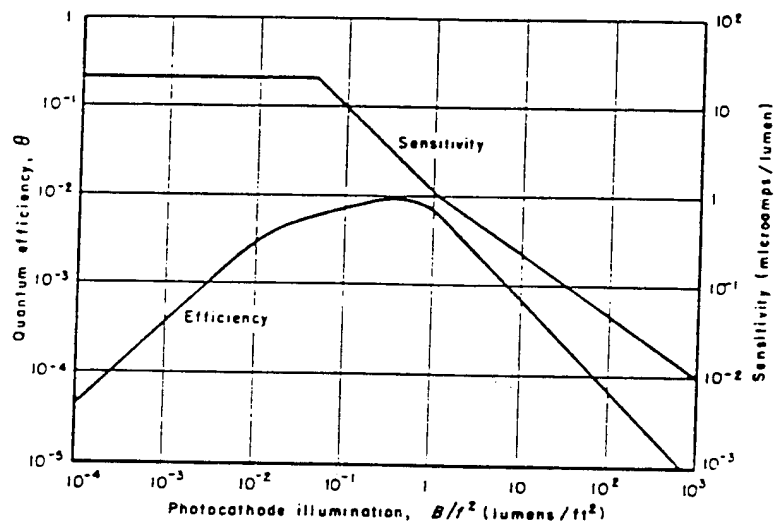

Fig. 48—Performance characteristics of Image Orthicon pickup tube

The quantum efficiency  $\theta$  is a measure of the sensitivity of the pickup device and is a function of scene brightness and therefore of the photocathode illumination. In the case of the Image Orthicon type of pickup tube (see Fig. 48),  $\theta$  increases from a value

of about  $10^{-5}$  at an incident illumination of  $10^{-4}$  lumens/ft<sup>2</sup> to a maximum of about  $10^{-2}$  at an illumination of about 1 lumen/ft<sup>2</sup> and then decreases with further increase in illumination in such manner that the product  $\theta(B/f^2)$  remains constant and equal in magnitude to about  $8 \times 10^{-3}$  for illumination levels higher than 1 lumen/ft<sup>2</sup>. This circumstance simplifies Eq. (5), with the result that the effective resolution in the high-light portions of a picture obtained with an Image Orthicon pickup tube at threshold operation under conditions of high-level illumination (values of  $B/f^2$  greater than unity) is given approximately by

$$n = \frac{9C^2}{\sqrt{N}} \quad (8)$$

As for the Vidicon-type pickup tubes, there is little quantitative information available in the literature pertaining to the functional dependence of its quantum efficiency upon incident illumination and frame frequency. General statements made in the one published article dealing with modern photoconductive camera tubes<sup>(48)</sup> would indicate that this type inherently possesses substantially higher sensitivity than photoemissive types under scene brightness conditions, resulting in photocathode illuminations greater than a few lumens per square foot. But time lag in the photoconductive target has been one of the greatest difficulties in the development of Vidicon pickup tubes, and it is doubtful whether this higher sensitivity would necessarily imply higher effective resolution at the relatively high frame frequencies which will be required in satellite television. The time constant of the target will also limit the performance of Image Orthicons, but to a less serious extent. While the effective resolution of the Vidicon probably varies with contrast as indicated in Eqs. (7) and (8), all following quantitative estimates of resolution as a function of contrast are confined to Image Orthicon camera tubes.

#### Over-all Resolution

The resolution of the television picture recorded by a movie camera at the ground station will be poorer than that of the pickup tube. The complete TV reconnaissance system may be regarded as a series of imperfect aperture processes, each possessing a finite resolving power which may be expressed in terms of resolution in TV lines per frame. The over-all or final resolution of the system has been shown<sup>(49)</sup> to be given by

$$n_n = \frac{1}{\sqrt{\sum_{i=1}^k \frac{1}{n_i^2}}} \quad (9)$$

where the  $n_i$ 's are the resolutions of the individual processes. In the case of the proposed system these are

- $n_1$ , the effective resolution of the TV camera optics
- $n_2$ , the effective resolution of the TV pickup tube
- $n_3$ , the effective resolution of the transmission link
- $n_4$ , the effective resolution of the kinescope
- $n_5$ , the effective resolution of the movie camera optics
- $n_6$ , the effective resolution of the movie camera film.

The resolutions  $n_1$  and  $n_2$  are determined by diffraction effects at the effective aperture of the respective lens systems and are given by

$$n = \frac{8.4 \times 10^4 \omega}{f} \quad \text{TV lines/frame,} \quad (10)$$

where  $f$  is the ratio of focal length to effective aperture and  $\omega$  is the width of the pickup tube phototarget or film frame, in inches, assuming circular apertures, white light, and focal fields at least equal in size to the phototarget or film frame. By using camera optics of suitably small  $f$  numbers,  $n_1$  and  $n_2$  can be made arbitrarily large compared with  $n_0$  and hence made to have a negligible adverse effect on  $n_0$ .

The resolution  $n_3$  is determined by the bandwidth of the transmission link, and with perfectly flat receiver and transmitter response characteristics, is simply equal to the number of scanning lines per frame. In general,  $n_3$  will be of the same order of magnitude as  $n_2$  and therefore will have a significant effect on  $n_0$ .

The resolution  $n_4$  is determined by the ratio of the effective width of the kinescope screen to the size of the scanning beam spot and, by using large-diameter kinescopes with well-designed electron optical systems, can be made large compared with  $n_2$ .

The resolution  $n_5$  is determined by the grain size of the photographic film; it is of the order of 140 TV lines/mm for slow, high-definition movie film, or about 2240 TV lines/frame for 35 mm film (16 mm frame height); by using sufficiently large film,  $n_5$  can also be made large compared with  $n_2$ .

For example, the over-all resolution of a system using a pickup tube having an effective resolution of 1000 TV lines/frame and an optic-kinescope-film-combined resolution of 3000 TV lines, will be about 950 TV lines/frame.

#### Scene Brightness in Satellite Television

The brightness of a diffusely reflecting surface is given by

$$B = \rho E, \quad (11)$$

where  $B$  = brightness, ft-L

$E$  = incident illumination, ft-c

$\rho$  = albedo, or coefficient of diffuse reflection, of the surface.

The upper surfaces of stratocumulus clouds approximate perfectly diffuse reflectors of albedo, given as a function of the thickness of the cloud stratum in Fig. 49. Since the clouds of principal interest will normally exceed a thickness of 200 meters, it is reasonable to use the generally accepted value of 0.8 for the albedo of average cloud formations.

The albedos of various terrestrial surfaces are given in Table 7.

The brightness of clouds of average albedo 0.8 illuminated by various extra-terrestrial sources is approximately as indicated in Table 8.

The daytime illumination provided by direct and scattered sunlight at the surface of the earth is a function of altitude, latitude, season of year, time of day, state of the atmosphere, and of the presence or absence of cloud cover between the sun and the surface area in question; it varies in value, at middle latitudes, from 100 to 200 ft-c

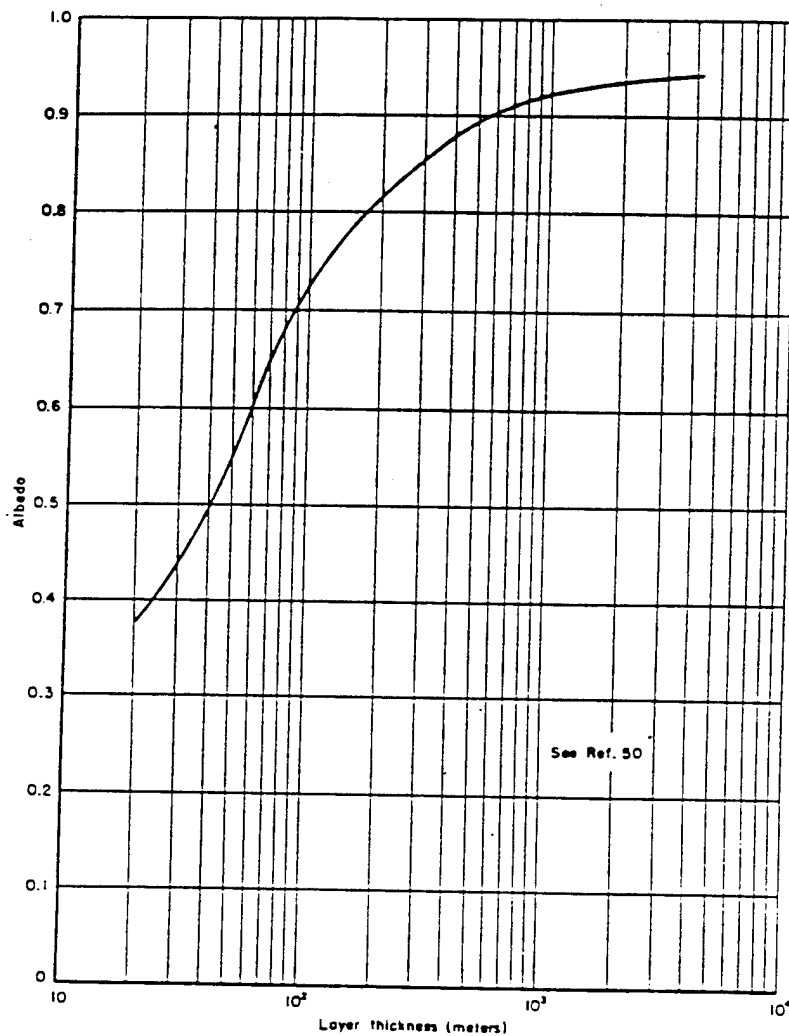

Fig. 49—Albedo of clouds as a function of cloud-layer thickness

near sunset or sunrise to more than 10,000 ft-c when the sun is near the zenith on a clear day. The brightness of the brighter surface objects, in daytime, will therefore range from about 100 to about 10,000 ft-L.

#### Scene Contrast

Contrast is defined in current television practice as

$$C = \left( \frac{B_B - B_D}{B_B} \right) 100\% = \left( \frac{P_B - P_D}{P_B} \right) 100\%, \quad (12)$$

where  $B_B$  and  $B_D$  are the brightness of adjacent brighter and darker areas in the scene

**Table 7**  
**ALBEDOS OF TERRESTRIAL SURFACE**

Ground Surface	Albedo	References
Fresh snow	.80-.93	51, 53, 54
Old snow, sea ice	.40-.60	53, 54
Brown soil	.32	52
Grass	.10-.33	54
Green leaves	.25	52
Sandy loam	.24	53
Sand	.13-.18	54
Asphalt paving	.15	53
Dry earth	.14	54
Rock	.12-.15	54
Moist earth	.08-.09	52, 54
Cultivated soil, vegetable	.07-.09	53
Smooth sea surface		
Solar elev 5 deg	.40	53
Solar elev 10 deg	.25	
Solar elev 20 deg	.12	
Solar elev 30 deg	.06	
Solar elev 40 deg	.04	
Solar elev 50-90 deg	.03	

**Table 8**  
**THE BRIGHTNESS OF STRATOCUMULUS CLOUDS\***

Source	Stellar Magnitude of Source	Illumination (ft-c)	Cloud Brightness (ft-L)
Sun	-26.7 m	10,000	8,000
Full moon	-12.7 m	0.025	0.02
Half moon	-10.2 m	0.0025	0.002
Night sky	- 8.5 m	0.0005	0.0004

\* The data in this table are based on the unweighted averages of widely different values found in astronomy, optics, and illumination engineering textbooks and in various handbooks. The light of the average moonless night sky, in north temperate latitudes, is taken as the equivalent of that emitted by 6000 first-magnitude stars.

viewed, respectively, and  $\rho_B$  and  $\rho_D$  are the corresponding surface albedos. The contrast of clouds of average albedo 0.8 viewed against various surface backgrounds is readily determined from the foregoing tables; typical ranges of values are as given in Table 9.

**Table 9**  
**CONTRAST OF CLOUDS AGAINST VARIOUS TERRESTRIAL BACKGROUNDS**

Background	Contrast (%)
Fresh snow .....	0-15
Old snow, sea ice .....	25-50
Ground (all kinds) .....	60-90
Smooth sea .....	50-95

**Minimum Scene Contrast**

It is evident from Eq. (8) that there will be a minimum scene contrast below which the effective resolution in the high-light portions of a picture obtained with an Image Orthicon camera tube may be expected to become rapidly less than the tube's limiting resolution. This minimum contrast is tabulated in Table 10 for typical values of frame frequency and limiting resolution.

**Table 10**  
**MINIMUM SCENE CONTRAST FOR LIMITING RESOLUTION (IMAGE ORTHICONS)**

Frame Frequency (per sec)	Minimum Contrast (%)		
	$n = 500$ TV Lines/In.	$n = 1000$ TV Lines/In.	$n = 1500$ TV Lines/In.
10	13	19	23
30	17	25	30
60	21	30	36

Depending on frame frequency and the limiting resolution of the pickup tube, there is a minimum scene contrast, averaging about 20 per cent, above which the effective resolution approximates the limiting resolution and below which effective resolution drops off so rapidly with contrast that the pictures are soon useless. For example, the effective resolution of an Image Orthicon pickup tube having a limiting resolution of 1000 TV lines/in. and operating under high-scene-brightness conditions at 30 frames/sec, will vary with scene contrast approximately as indicated in Table 11.

**Table 11**  
**EFFECTIVE RESOLUTION AS A FUNCTION**  
**OF SCENE CONTRAST**

Contrast (%)	Effective Resolution (TV lines/in.)
100	1000
50	1000
25	1000
20	650
15	370
10	165
5	40
2	6.5
1	1.6

#### Surface Coverage and Focal Length

The angle of view of the satellite's television camera is given by

$$\alpha = \frac{u}{F} = \frac{D}{b} \quad \text{radians,} \quad (13)$$

where  $D$  is the width of the surface area viewed, in miles. From the point of view of resolving power, it is desirable (see Eq. 3) that the ratio  $F/u$  be large. The angle of view will therefore be small, and the width  $D$  of the "square" of surface viewed in a given frame will be small compared with the height of the satellite. But if the satellite is to be useful in surface reconnaissance, it should provide a coverage, on each orbital revolution, of a belt of surface having a width comparable with, and preferably larger than, the height of the orbit. It is therefore necessary that the camera incorporate an optical-scanning mechanism by which the small angle of view may be swept through the much larger angle over which coverage is desired.

The simplest means of scanning a wide-surface belt as the satellite sweeps by in its orbit would be to have a series of approximately transverse strips, each having a length  $l$  equal to the width of the belt and having a width  $D$  in the direction of motion. Each strip would be scanned by lateral deflection of the optical axis of the camera by means of an inclined mirror actuated by a Swiss-gear escapement, or similar intermittent or optical equivalent mechanism (see Fig. 14, page 19). The time  $t$  available for scanning each strip is equal to that required for the radius vector to the satellite to move through the distance  $D$  on the surface, that is,

$$t = \frac{D}{V} = \frac{b}{V \frac{F}{u}}, \quad (14)$$

where  $V$  is the linear velocity of the satellite referred to the surface. The minimum number of individual pictures, or "looks," in each transverse strip is given by the ratio of



the coverage angle  $2\gamma$  (the total angle subtended by the belt width, or strip length,  $s$ ) to the angle of view, that is,

$$\text{Number of looks} = \frac{2\gamma}{\alpha} = 2\gamma \frac{F}{w}, \quad (15)$$

and, therefore, the minimum number of looks, or frames, per second is given by

$$N_{\min} = \frac{2\gamma V}{b} \left( \frac{F}{w} \right)^2, \quad (16)$$

where  $2\gamma$  is the coverage angle in radians\* and  $V$  is the surface velocity in miles per second. This relation determines a maximum usable value of  $F/w$  consistent with complete coverage of a belt of given width at a given frame frequency. For example, in the case of a 350-mi-altitude satellite used for reconnaissance over a belt of surface 800 mi wide,  $2\gamma$  is approximately  $90^\circ$  (1.57 radians) and  $V$  is about 4.7 mi/sec (neglecting the rotation of the earth), and the maximum value of  $F/w$  for various frame frequencies is as tabulated below:

Frame Frequency	$\frac{F}{w}$
10 .....	22
30 .....	38
60 .....	53

Presently available pickup tubes employ square phototargets of widths ranging from about  $\frac{3}{8}$  in. in a small Vidicon to about  $1\frac{1}{4}$  in. in the large commercial Image Orthicon; focal lengths ranging from 14 to 40 in., depending on the type and size of the pickup tube used, are therefore the largest, consistent with the specified coverage at ordinary frame frequencies (about 30/sec). Time lag in the target (picture "sticking") may cause deterioration of effective resolution, at higher frame frequencies, particularly with

\* The coverage angle  $2\gamma$  is given in terms of the belt width  $s$ , the orbital height  $b$ , and earth's radius  $R_E$  by the relation

$$2\gamma = 2 \sin^{-1} \left[ \frac{\sin \left( \frac{s}{2R_E} \right)}{\sqrt{\left( \frac{R_E + b}{R_E} \right)^2 - 2 \left( \frac{R_E + b}{R_E} \right) \cos \left( \frac{s}{2R_E} \right) + 1}} \right]$$

and the values of  $2\gamma$  corresponding to various values of  $s$  are tabulated below for the case of a 350-mi orbital altitude:

$s$ (miles)	$2\gamma$ (radians)
350 .....	0.90
700 .....	1.40
1400 .....	2.04
2800 .....	2.32

The widest belt width given is that at the edges of which rays from the satellite are incident at a grazing angle of  $5^\circ$ , the minimum below which atmospheric absorption and distortion will rapidly deteriorate the quality of observations (see also Fig. 46, page 85).

---

present Vidicons, under circumstances requiring that each successive frame constitute a look at an entirely different scene. (It is well to point out again that these considerations are conservative in view of the Columbia Broadcasting Company's sequential color system where 144 different frames/sec are used.)

### Camera Aperture

The minimum aperture required for daytime-only operation of a satellite television camera is determined by two considerations:

**Pickup-Tube Illumination.** The sensitivity of present pickup tubes, both Image Orthicons and Vidicons, is such as to require photocathode illumination in excess of about 1 lumen/ft<sup>2</sup> for optimum performance, i.e., for effective resolution approximating the limiting resolution of the tube. Neglecting lens losses, this illumination is given by the scene brightness in foot-Lamberts divided by the square of the camera  $f$  number. The brightness of clouds illuminated by sunlight will be of the order of 2000 to 9000 ft-L, depending on cloud thickness; the daytime brightness of large surface objects will lie in the range 100 to 10,000 ft-L, depending on the elevation of the sun, the presence of clouds between the sun and the object in question, and its reflection coefficient. Taking 100 ft-L as the minimum brightness which need be considered in daytime reconnaissance, it follows that the maximum camera  $f$  number is about 10 and, therefore, that the minimum usable camera aperture will be about one-tenth the focal length.

**Aperture Diffraction.** Diffraction effects at the camera aperture reduce the over-all resolution  $n$ , of a television camera to a value less than that of the pickup tube  $n_0$ . It is easily shown that the fractional reduction in resolution caused by diffraction of white light at a circular aperture is given approximately by

$$\Delta = \frac{n - n_0}{n} \approx \frac{1}{2} \left( \frac{n_0 f}{8.4 \times 10^4} \right)^2 \quad (17)$$

where  $n$  is the resolution of the pickup tube in TV lines per inch and  $f$  is the  $f$  number of the optical system. Since it is much easier to increase the size of the aperture, thus reducing the adverse effects of diffraction, than to increase pickup tube resolution, this relation determines a maximum value of  $f$  for a given tolerable reduction in resolution. Taking 5 per cent as the largest allowable decrement in resolution and 1500 TV lines/in. as the largest tube resolution which need be considered, the maximum usable  $f$  number will be about 18.

It is apparent that the optical design of the camera will present no problems, since for daytime operation any  $f$  number less than about 10 will be satisfactory.

### Contrast and Signal-to-Noise Ratio

The minimum signal-to-noise ratio,  $S/N$ , required for transmission of a picture of contrast  $C$  per cent is given approximately by the relation

$$S/N = \frac{500}{C} \quad (18)$$

Given this signal-to-noise ratio, the effective resolution of the pickup tube for low scene contrasts drops off from its maximum or limiting value as the contrast squared. The transmitter power output required varies directly with the signal-to-noise ratio and hence inversely with the contrast. While the sensitivity of present pickup tubes is great enough to provide output signal-to-noise ratios in excess of 100:1\* at high scene brightness, it is evident that it will be impractical to attempt to push operations to correspondingly low contrast levels. The optimum minimum working contrast is probably that at which effective resolution starts to drop off from the limiting resolution of which the tube is capable: this value is determined by the type (i.e., its quantum efficiency and limiting resolution) and the frame frequency discussed above. For example, in the case of an Image Orthicon of 1000 TV lines/in. resolution operated at 30 frames/sec, this minimum contrast is about 25 per cent, corresponding to a required signal-to-noise ratio of 20:1. Operation of this tube under the same conditions on a scene contrast of 10 per cent would require a signal-to-noise ratio of 50:1, or 2.5 times as much output power (assuming 100 per cent modulation), and would result in an effective resolution of about only 165 TV lines/in. At extremely low contrasts, enormous powers will be required to transmit a picture containing practically no information, assuming, of course, that sufficient bandwidth to transmit a high-contrast picture is provided.

#### Bandwidth

A television picture of resolution  $n'$  TV lines/frame contains approximately  $(n')^2$  discrete elements, the signal for each of which may vary in magnitude through  $m$  half-tone steps. The maximum information content,  $I$ , of such a picture is therefore given by

$$I = m^{(n')^2}. \quad (19)$$

The device generating these pictures must be matched by a transmission channel of equal capacity, given in standard information theory by the relation

$$I = \left( \frac{S/N}{k} \right)^{2t\Delta f} \quad (20)$$

in which  $\Delta f$  is the channel bandwidth in cycles per second,  $t$  is the transmission time per picture frame (the reciprocal of  $N$ , the frame frequency), and

$$\frac{S/N}{k} = \frac{500/C}{5} = \frac{100}{C} = m, \quad (21)$$

the number of half-tone steps. It follows that the bandwidth required for transmission, in megacycles per second, is given by

$$\Delta f = \frac{1}{2} (n')^2 N \approx 10^{-6}, \quad (22)$$

and, when tabulated for the various resolutions, is as follows:

\* Practical values are about 80:1.

Frame Frequency (per sec)	Bandwidth (Mc/sec)		
	$n' = 500$ TV Lines/In.	$n' = 1000$ TV Lines/In.	$n' = 1500$ TV Lines/In.
10	1.25	5.0	11.25
30	3.75	15.0	33.75
60	7.5	30.0	67.5

The ground receiver bandwidth in a satellite television system will have to be somewhat greater than the above figures to allow for a Doppler shift of the carrier frequency due to the high radial velocity of the satellite with respect to the ground station; for example, in the case of a 350-mi-altitude satellite, a 10,000 Mc television carrier frequency may be shifted by  $\pm 0.13$  Mc.

The required transmitter output power is directly proportional to the bandwidth. Other things being equal, the combined drain of the transmitter, the modulator, and their power supply from the primary source of power will also be proportional to bandwidth.

#### Resolution by Day

Table 12 gives the approximate values of  $\delta$ , the size in feet of the smallest surface object resolvable in daytime television reconnaissance from a satellite in a 350-mi orbital altitude, as a function of scene contrast and pickup tube resolution for several typical operating conditions. The "object" may be a detail of cloud structure or any terrestrial surface not obscured by clouds. Its dimension is computed from Eqs. (3) and (8) subject to the following assumptions:

1. That the television camera incorporates an Image-Orthicon-type pickup tube having a photocathode 1 in. square.
2. That the television camera incorporates an  $f/10$  optical system of negligible transmission loss;
3. That the high-light scene brightness is greater than about 100 ft-L, so that the photocathode illumination will be greater than about 1 lumen/ft<sup>2</sup>;
4. That the capabilities of the transmitting, receiving, and recording facilities are such that the over-all resolution of the system approaches that of the camera;
5. That coverage of a strip of surface of specified width is required per orbital revolution and is accomplished by means of an optical-scanning mechanism so arranged that each frame constitutes a look at a different piece of terrain;
6. That the frame frequency and camera focal length are so chosen as to be consistent with the surface coverage required and with the attainment of the limiting resolution on scenes of contrast greater than about 20 to 25 per cent.

Data are given in the table for systems covering surface belts 800 and 80 statute mi wide, respectively, using both low and medium picture transmission rates (10 and 30

Table 12

**SMALLEST RESOLVABLE SURFACE DIMENSIONS BY DAY**

WIDE COVERAGE (Surface Belt 800 Mi Wide p.. Orbital Revolution)						
10/Sec Frame Frequency, 20-In. Focal Length, 2-In. Camera Aperture						
Contrast (%)	Resolution					
	500 TV Lines/In.		1000 TV Lines/In.		1500 TV Lines/In.	
	$\delta$ (ft)	$P^*$	$\delta$ (ft)	$P^*$	$\delta$ (ft)	$P^*$
$\geq 25$	370	0.25	185†	1.0†	125	2.3
20	370	0.31	185	1.3	165	2.8
15	370	0.42	295	1.6	295	3.8
10	660	0.63	660	2.5	660	5.6
5	2700	1.25	2700	5.0	2700	11.0
30/Sec Frame Frequency, 35-In. Focal Length, 3.5-In. Camera Aperture						
$\geq 50$	210	0.75	105	3.0	70	6.8
25	210	0.75	105	3.0	105	6.8
20	210	0.94	160	3.8	160	8.4
15	285	1.3	285	5.0	285	11.0
10	640	1.9	640	7.5	640	17.0
5	2600	3.8	2600	15.0	2600	34.0
NARROW COVERAGE (Surface Belt 80 Mi Wide per Orbital Revolution)						
10/Sec Frame Frequency, 55-In. Focal Length, 5.5-In. Camera Aperture						
$\geq 25$	135	0.25	70	1.0	45	2.3
20	135	0.31	70	1.3	60	2.8
15	135	0.42	105	1.6	105	3.8
10	240	0.63	240	2.5	240	5.6
5	950	1.3	950	5.0	950	11.0
30/Sec Frame Frequency, 95-In. Focal Length, 9.5-In. Camera Aperture						
$\geq 50$	80	0.75	40	3.0	24	6.8
25	80	0.75	40	3.0	40	6.8
20	80	0.94	60	3.8	60	8.4
15	105	1.3	105	5.0	105	11.0
10	240	1.9	240	7.5	240	17.0
5	950	3.8	950	15.0	950	34.0

\* Ratio of power required for information transmission to that necessary for datum case.  
 † Datum case.

---

frames/sec, respectively). The camera focal length specified in each instance is close to the maximum consistent with the indicated coverage and frame frequency.

Data are also given for three values of  $n'$ , the limiting resolution of the television camera:

- 500 TV lines/frame—typical of commercial practice and probably attainable in the satellite at the cost of relatively minor effort;
- 1000 TV lines/frame—typical of the best present production equipment, possibly realizable in satellite operation after major development effort;
- 1500 TV lines/frame—realized in present experimental cameras under laboratory conditions, possibly realizable in the satellite after intensive research and development effort.

Table 12 also includes the corresponding values of the relative power  $P$  required for picture transmission, on the basis of unity for a system having a 20:1 maximum signal-to-noise ratio and a 5-Mc bandwidth (equivalent to 1000 scanning lines/frame at 10 frames/sec). It should be noted that unless the number of scanning lines per frame is considerably greater than the camera resolution, the over-all resolution of the system will be less than that of the camera, and the value of  $\delta$  will be greater than indicated in the table (see "Over-all Resolution," page 92). One important feature of the television system is that the number of "bits" of information that make up the picture are determined by the product of the frame frequency and the square of the number of lines of resolution of the system (almost that of the camera tube itself if the rest of the system components have sufficiently high resolutions). The power to transmit the picture is directly proportional to the number of "bits" being sent at a given time. Thus, if a high frame frequency can be used, the tube resolution need not be as high as that with a low frame frequency. For example, a 150/sec frame frequency with a tube resolution of 250 TV lines is equivalent to a 10/sec frame frequency and 1000 TV lines. Since completely different frames at the rate of 144/sec are used in the Columbia Broadcasting System's sequential color system, and if such a system can be shown to be directly analogous to the satellite's system, it may be well to consider a frame frequency of this magnitude. A frame frequency of 180/sec has also been used with some success by CBS. Assuming an 800-mi scanning width and a 1000-TV-line tube resolution, it may be found that the 185-ft minimum resolvable surface dimension corresponding to 10/sec frame frequency can be reduced to 60 ft at 150/sec frequency. To retain the 10/sec frequency but increase the tube resolution would require, for 60-ft minimum resolvable surface dimensions, a tube resolution of 3000 lines. Thus it appears logical to increase the frame frequency to as high a value as possible, which seems to be easier from a development standpoint than increasing the tube resolution.

#### **Resolution by Night**

Television reconnaissance from a satellite is possible by moonlight and even by the light of a moonless night sky, but it will require a camera of very large aperture. The

---

results will, in general, be far inferior to those attainable by day.

The Image Orthicon type of pickup tube is the only one presently available which is sufficiently sensitive to permit operation under the low scene-brightness levels obtained at night, and even this tube will require an optical system of maximum light-gathering power. It is assumed that a Schmidt camera of effective  $f$  number 0.7 will be about the fastest practical in this application. Such a camera will have a physical aperture approximately 50 per cent greater than its focal length and will therefore be a rather cumbersome piece of equipment.

Assuming a pickup tube photocathode width  $w$  of 1 in., the ratio  $F/w$  for the largest practical nighttime camera will be about 20. For continuous coverage of a belt of surface 800 mi wide from a satellite in a 350-mi-altitude orbit, a minimum frame frequency  $N$  of about 10/sec is required (see Eq. 14).

The brightness of clouds, or other high reflection surfaces, of albedo about 0.8 will average approximately  $10^{-2}$  ft-L during the second and third quarters of the moon and about  $4 \times 10^{-4}$  ft-L by the light of the night sky. With an  $f/0.7$  optical system, these brightnesses correspond to photocathode illuminations of  $2 \times 10^{-2}$  and  $8 \times 10^{-4}$  lumens/ft<sup>2</sup>, respectively. At these levels of illumination, the quantum efficiency of an Image Orthicon pickup tube is, respectively, about  $5 \times 10^{-3}$  and  $4 \times 10^{-4}$  (see Fig. 48).

The size in feet of the smallest surface dimension resolvable at night by a system possessing the above parameters is readily calculated by means of Eqs. (3) and (7). Approximate values of this quantity,  $\delta$ , are tabulated in Table 13 as a function of scene contrast for various values of the limiting resolution of the system:

It is evident that except for operation against scenes of high contrast illuminated by bright moonlight, the performance of the large nighttime camera is markedly inferior to that of the much smaller daytime system and essentially independent of the limiting resolution of the camera. This is due to the fact that under the low photocathode illumination levels attainable at night and the correspondingly low quantum efficiencies of the pickup tube, the effective resolution is generally much less than limiting. Resolving power is therefore determined largely by scene contrast, frame frequency, and focal length. With the maximum focal length of a large-aperture camera dictated by space considerations and with the minimum usable frame frequency determined by surface coverage requirements, nothing much can be done to improve performance other than to increase the tube sensitivity at given light levels. As mentioned in Appendix I, it is probable that an iris of the graded filter variety will be needed to control the photocathode illumination, since even in the daytime considerable range of light levels exists. Progress attained during recent years in increasing the quantum efficiency of television pickup tubes at low photocathode illumination levels is indicated in Table 14, based on data given in the previously referenced paper by Rose.<sup>(47)</sup>

It is concluded that, pending the development of pickup tubes considerably more sensitive than Image Orthicons at low scene-brightness levels, nighttime reconnaissance will be relatively impractical.

**Table 13**  
**SMALLEST RESOLVABLE SURFACE DIMENSIONS BY NIGHT**

COVERAGE—Surface Belt 800 Mi Wide per Orbital Revolution  
(10/Sec Frame Frequency, 20-In. Focal Length, 30-In. Camera Aperture)

By Moonlight (Second and Third Quarters)

Contrast (%)	Resolution		
	500 TV Lines/In.	1000 TV Lines/In.	1500 TV Lines/In.
	$\delta$ (ft)	$\delta$ (ft)	$\delta$ (ft)
100	370	185	125
50	370	235	235
25	925	925	925
10	5,800	5,800	5,800
5	23,000	23,000	23,000

By Light of the Moonless Night Sky

100	1,000	1,000	1,000
50	4,000	4,000	4,000
25	16,000	16,000	16,000
10	100,000	100,000	100,000
5	400,000	400,000	400,000

**Table 14**  
**QUANTUM EFFICIENCY OF VARIOUS PICTURE PICKUP DEVICES**

Photocathode Illumination, $B/f^2$ (lumens/ft <sup>2</sup> )	Image Dissector, 1934	Iconoscope, 1937	Orthicon, 1939	Image Orthicon, 1946
$10^{-4}$	$10^{-1}$	.....	.....	$5 \times 10^{-4}$
$10^{-3}$	$10^{-1}$	.....	.....	$5 \times 10^{-4}$
$10^{-2}$	$10^{-1}$	.....	.....	$2 \times 10^{-3}$
$10^{-1}$	$10^{-1}$	$8 \times 10^{-1}$	$4 \times 10^{-4}$	$9 \times 10^{-3}$
1	$10^{-1}$	$8 \times 10^{-4}$	$4 \times 10^{-3}$	$8 \times 10^{-3}$

**Space, Weight, Tube Complexity, and Power Requirements of Camera**

The design and development of a long-lifetime, completely unattended (rather than merely remotely controlled), space-borne television camera has never been attempted, and consequently there is no background of really pertinent experience upon which to base an estimate of the space, weight, and power requirements of a television camera for satellite reconnaissance. The order-of-magnitude estimates of these quantities, shown



in the tabulation below, are essentially extrapolations from past experience with airborne television cameras and with commercial remote-controlled pickup equipment, modified by allowances for possible improvements via subminiaturization and other new techniques. It is presumed that the camera will incorporate an Image-Orthicon-type pickup tube having a photocathode approximately 1 in. square; a four-stage video amplifier; horizontal and vertical deflection oscillators and their associated circuitry; orthicon-and-kinescope-blanking pulse generators; synchronizing oscillator; and stabilized high-voltage supplies. It is ~~also~~ presumed that the camera will have an  $f/10$  optical system with a 2- to 6-in. effective aperture, including an optical-scanning mechanism synchronized with the camera frame frequency.

	Approximate Quantities
Volume .....	0.75 ft <sup>3</sup>
Weight .....	145 lb
Number of vacuum tubes .....	25
Power input (28 v and 150-350 v d-c) .....	230 watts

It is possible that a small reduction in power required and a moderate reduction in the number of vacuum tubes can be effected by use of a Vidicon type of pickup tube. This tube is simpler in construction than the Image Orthicon, with fewer high-voltage electrodes to be supplied and controlled.

## SATELLITE-TO-SURFACE COMMUNICATION—OBLIQUE ORBIT

### Transmission Circuit Parameters

Information gathered by the satellite television camera may be transmitted via radio to a succession of strategically located ground stations. The required television transmitter output power is readily determined from the standard one-way propagation equation

$$P_r = (S'/N') \overline{NF} k T \Delta f = \frac{EPGA}{4\pi R^2} \quad (23)$$

where  $P_r$  = received power, watts

$S'/N'$  = high-light signal-to-noise ratio, *power* [= ( $S/N$  in voltage)<sup>2</sup>]

$\overline{NF}$  = receiver-noise figure

$k$  = Boltzmann constant, joules/°K

$T$  = absolute receiver temperature, °K

$\Delta f$  = receiver bandwidth, cycles/sec

$E$  = over-all efficiency

$P$  = transmitter power, watts

$G$  = gain of the transmitting antenna

$A$  = effective area of the receiving antenna, m<sup>2</sup>

$R$  = transmission range, m.

Assuming circular pencil-beam antennas having a gain factor of about 0.6 for both transmission and reception and expressing the quantities  $G$  and  $A$  in terms of the

diameters of the respective antennas, the propagation equation reduces to

$$\frac{Pd^2D^2}{\lambda^2} = \frac{0.052R^2(S'/N')\overline{NF}kT\Delta f}{E} \quad (24)$$

where  $d$  = diameter of the satellite's antenna (transmitting), ft  
 $D$  = diameter of the ground station's antenna (receiving), ft  
 $\lambda$  = transmission wavelength, cm.

For the case of a 350-mi-altitude satellite, the maximum transmission range, corresponding to a minimum satellite elevation of  $5^\circ$  with respect to a ground station, is about 1400 statute mi, or  $2.25 \times 10^6$  m. The minimum acceptable high-light signal-to-noise ratio  $S'/N'$  (in power) is taken as 400:1 (equivalent to 20:1  $S/N$  in voltage). A receiver noise figure of 20 is typical of good design in the centimeter wavelength band. The numerical value of  $kT$  is approximately  $4 \times 10^{-21}$  joules at standard temperature. A receiver bandwidth of  $5 \times 10^6$  cps is sufficient to permit transmission of information at a rate equivalent to that used in current commercial television practice with an ample allowance for Doppler shift of the carrier frequency due to the radial component of the orbital velocity of the satellite. An over-all efficiency of 0.25 allows for 2.5 db losses in both the transmitting and receiving systems plus a maximum of 1 db in atmospheric attenuation. Substitution of these values into the preceding expression leads to

$$\frac{Pd^2D^2}{\lambda^2} = 125 \quad (1)$$

Practical diameters of the satellite's transmitting and the ground station's receiving antennas are about 1 ft and 16 ft, respectively. The minimum wavelength consistent with about 1 db atmospheric attenuation under moderately adverse weather conditions may be shown to be about 3 cm. It follows that the required transmitter output power (peak carrier power for 100 per cent modulation) is about 4.4 watts.

The assumed and derived parameters of the television transmission circuit are tabulated below:

Frequency .....	10,000 Mc (wavelength, 3 cm)
Transmitter power .....	4.4 watts
Receiver noise figure .....	20
Receiver bandwidth .....	5 Mc
Signal-to-noise ratio (power) .....	400:1
Total losses .....	6 db
Satellite's transmitting antenna:	
Diameter .....	1 ft
Power gain .....	210
Beamwidth .....	$13^\circ$ (half-power)
Ground station's receiving antenna:	
Diameter .....	16 ft
Power gain .....	33,600
Beamwidth .....	$0.8^\circ$

The reader is referred to Section II, pages 31 through 34, for a description of the antenna-tracking system.

### Weight, Space, and Power Requirements of Transmission System

Rough estimates of the space, weight, and power requirements of the satellite's electronic equipment, exclusive of the television camera, assuming intensive design and development effort, are given in Table 15.

**Table 15**  
**ESTIMATED WEIGHT, SPACE, AND POWER REQUIREMENTS**  
**OF TRANSMISSION SYSTEM**

Equipment	Weight (lb)	Power Input (watts)	Volume (ft <sup>3</sup> )	Number of Vacuum Tubes
Transmitter-modulator	20	50	0.25	8
Tracking receiver and associated circuitry	10	30	0.25	10
Antenna and associated motors, servos, etc.	10	20	0.75 (1 ft diam)	

### Atmospheric Absorption and Maximum Usable Frequency

The latest available data on microwave propagation losses due to oxygen and water-vapor absorption and to Rayleigh scattering by condensed water droplets<sup>(5,7)</sup> lead to the following figures for total atmospheric attenuation, in db per kilometer, for various wavelengths under various meteorological conditions (see Table 16).

**Table 16**  
**TOTAL ATMOSPHERIC ATTENUATION AS FUNCTION**  
**OF WAVELENGTH**

Wavelength (cm)	Total Attenuation in Db per Kilometer				
	Dry Air	100% RH	Rain: 1 mm/hr	Rain: 15 mm/hr	Cloudburst
1.3	0.010	0.35	0.48	2.0	12.0
2.0	0.008	0.038	0.088	0.90	6.5
3.0	0.0076	0.015	0.034	0.31	3.3
4.0	0.0072	0.011	0.021	0.16	1.6
6.0	0.0071	0.0084	0.011	0.048	0.38
10.0	0.0070	0.0073	0.0077	0.011	0.040
14.0	0.0069	0.0069	0.0070	0.008	0.016

Cloudbursts and tropical downpours (intensity of the order of 100 mm/hr) are local phenomena of short duration and infrequent occurrence. Rainfall is also, of course, localized in depth through the atmosphere. It is assumed therefore that total atmospheric attenuation figures corresponding to conditions of light rainfall (1 mm/hr) are

the least favorable which need be considered here.

Molecular absorption and small-particle scattering result in purely additive losses. It can be shown that the attenuation of the actual atmosphere is reasonably well approximated by that of a uniform atmosphere at standard temperature and pressure and about 4.0 km thick. The total attenuation in db, ground station to satellite, is given by

$$L_a = K(\sqrt{R_E^2 \sin^2 \alpha + 8R_E} - R_E \sin \alpha) \quad \text{db}, \quad (25)$$

where  $R_E$  is the radius of the earth in kilometers,  $\alpha$  is the angular elevation of the satellite in degrees, and  $K$  is the function of wavelength defined by the numbers in the first and fourth columns of Table 16; this relation is plotted in Fig. 50.

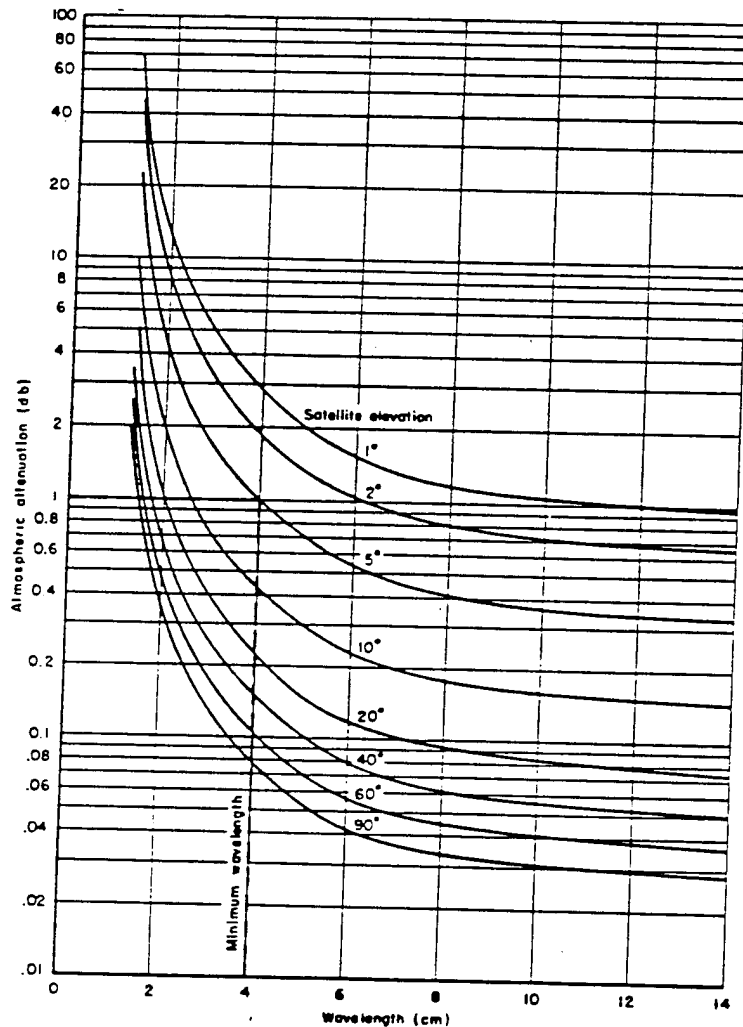

Fig. 50—Total atmospheric attenuation as a function of wavelength (350-mi-orbital altitude, 1 mm/hr rainfall)

---

It will be recalled that the choice of transmission frequency and the vulnerability of the satellite to enemy detection, tracking, monitoring, and interference were discussed in Section II.

#### **SATELLITE-TO-SURFACE COMMUNICATION—EQUATORIAL ORBIT**

In the case of a satellite in an oblique orbit, the direction of transmission from the satellite to a given ground receiving station is continuously varying in both angular coordinates. It was shown that it is necessary to use a steerable pencil-beam antenna with the satellite's television transmitter. While this antenna can be made to have relatively high gain; thus minimizing the required transmitter output power and the size of the ground station's receiving antenna, the system has the disadvantage of requiring the additional complication of a tracking receiver, operating upon the signal from a beacon at the ground station, to maintain the axis of the antenna in the direction of the receiving station.

In the preliminary stages of development of the satellite as a reconnaissance vehicle, it will probably be convenient to employ an equatorial orbit in which the satellite will pass repeatedly over a string of ground stations spaced along the earth's equator. In this case, the direction of transmission from satellite to a given ground station will vary substantially only in elevation, and it will be possible to use a fixed fan-beam transmitting antenna having a pattern shaped to fit the orbit. This will permit dispensing with the tracking receiver, the ground beacon, and other complications incident to the use of a steerable transmitting antenna. Problems involved in the design of a fixed antenna system for a satellite in a 400-mi-high, circular, equatorial orbit are discussed in Ref. 56.

### APPENDIX III

## INFRARED ENERGY AVAILABLE FOR GUIDING ON THE HORIZON AND YAW ERROR DETECTION

If two parallel infinite planes are separated by any distance whatever and one of them is radiating uniformly an energy  $E_0$  per square centimeter, then this same amount of energy will be falling everywhere on the other plane. If the portion of the radiating plane that can be seen from a particular point on the absorbing plane is reduced from the solid angle  $2\pi$  steradians to  $\Omega$  steradians, then the energy received at this point will be  $E_0\Omega/2\pi$ . Figure 51 shows a lens of area,  $A$ , forming an image of area,  $a$ , of a portion of a plane surface subtending a solid angle,  $\Omega$ . This surface is radiating energy at the rate of  $E_0$  watts per square centimeter. By the above reasoning, the amount being transmitted by the lens to the area,  $a$ , is  $AE_0(\Omega/2\pi)$ . Except for absorption, all this energy is spread uniformly over the area,  $a$ , in the focal plane (for small angular fields). Therefore, the energy density in the focal plane is  $(A/a)E_0(\Omega/2\pi)$ . If  $D$  is the diameter of the lens and  $d$  is the diameter of the image (assuming it is circular), then the energy density in the image is:

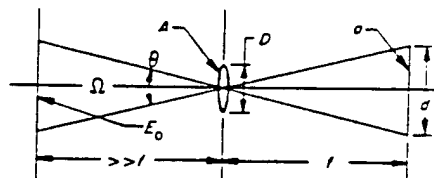

Fig. 51—Relation between object and image brightness

$$E_i = \frac{D^2}{d^2} E_0 \frac{\Omega}{2\pi} \quad (26)$$

If  $\theta$  is the angular field of the lens, then for small values of  $\theta$  ( $10^\circ$  or less), within 10 per cent,

$$2d = f \tan \theta \cong f\theta, \quad (27)$$

and for small angles,

$$\Omega \cong \frac{\pi}{4} \theta^2. \quad (28)$$

By substituting (27) and (28) into (26),

$$E_i \cong \frac{E_0}{8(f/\text{number})^2} \quad (29)$$

### YAW ERROR DETECTION

Since the horizon is symmetrical with respect to the vehicle's yaw axis, guiding on the horizon cannot be used for yaw error detection. In an earlier RAND report,<sup>(10)</sup> a

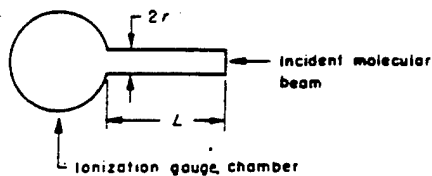

device was proposed that would use the techniques of molecular beam detection to measure the angle of attack in yaw. Some recent theoretical and experimental investigations<sup>(57), (58)</sup> have produced a simple and reliable device that is applicable to this

problem. The sensitive element is a short tube which is open at one end and has a bulb or reservoir at the other (as shown in the sketch). This bulb or reservoir can be the envelope of an ionization gauge. The molecular beam is produced by an opening in the skin of the vehicle on the forward part. Since the incident beam is roughly collimated by the high forward velocity of the vehicle, the molecules suffer fewer reflections from the side of the tube on the way into the reservoir than they do as they emerge. Hence there is an increase in pressure produced in the reservoir owing to the presence of the tube. It has been shown<sup>(57)</sup> that for values of  $L/r$  of 100 (see sketch), the pressure in the reservoir is increased over the dynamic pressure produced by a factor of 350 when the air stream impinges on the open end of the tube. Subsequent experimental work<sup>(58)</sup> has confirmed the theoretical results of the earlier investigation<sup>(57)</sup> and has yielded the additional information that for values of  $L/r$  of 100, the system has a time constant of about 15 sec. If the tube were set with its axis parallel to the longitudinal axis of the vehicle, the pressure would be maximum, but the sensitivity to error in yaw would be vanishingly small. If the tube is perpendicular to the direction of motion, the sensitivity is maximum, but the pressure is zero. In general, if  $\theta$  is the angle between the direction of motion and the axis of the tube, then the component of the dynamic pressure that enters the tube is

$$P = KP_D \cos \theta,$$

where  $P_D$  is the total dynamic pressure and  $K$  is the pressure amplification caused by the tube. If the vehicle yaws slightly, the change in this component (the quantity to be measured) is

$$dP = -KP_D \sin \theta d\theta.$$

In Ref. 58,  $dP$ , the minimum detectable increment in pressure in a laboratory setup, is stated to be  $8 \times 10^{-10}$  mm of mercury. To ensure an adequate signal-to-noise ratio and to make allowance for the fact that fine adjustments are not possible after the vehicle is launched, a value 100 times larger than this will be used, i.e.,  $8 \times 10^{-8}$  mm. By using the least favorable atmospheric model, the dynamic pressure on a 350-mi-altitude orbit will be  $1.4 \times 10^{-7}$  mm, and on a 500-mi-altitude orbit,  $6 \times 10^{-9}$  mm. The least detectable change in yaw is then

$$d\theta = \frac{-dP}{KP_D \sin \theta}.$$

---

Setting the tube at  $45^\circ$ ,

$$\sin \theta = 0.7$$

$$dP = 8 \times 10^{-8}$$

$$P_D = 1.4 \times 10^{-7}$$

$$K = 350,$$

which gives  $d\theta = 0.13^\circ$  for the 350-mi orbit. For the 500-mi orbit and its least favorable atmospheric model,  $d\theta = 3^\circ$ .

Because of time lags in a servo system, it is never possible to position the controlled member as accurately as its error can be measured. Since the half-power beamwidth of the antenna will be of the order of  $2^\circ$ , this error is too large, and some complications in the molecular beam detector must be introduced to increase its sensitivity to angular deviations. For instance, if the entrance to the tube is set back far enough inside the vehicle behind a hole in the skin, the simple  $\cos \theta$  law no longer applies, and increased sensitivity to yaw errors could be obtained.



---

**APPENDIX IV**  
**EQUATIONS OF MOTION FOR THE SATELLITE'S**  
**ATTITUDE-CONTROL FLYWHEELS**

Two systems for effecting satellite attitude control, one using the principle of the precession of gyroscopes and the other that of the angular momentum of flywheels, were discussed in Section III. Analysis of the equations of motion pertaining to the gyro system were presented in detail in Ref. 17. To our knowledge, however, no prior investigation has been made for the flywheel system, which is therefore presented here.

The coordinate system used is fixed in the vehicle: positive  $x$  direction, forward; positive  $y$ , to the starboard; positive  $z$ , downward. The following notation will be used:

- $\mathbf{P}$  = angular momentum of vehicle with respect to an inertial reference system,
- $\mathbf{M}$  = the control momentum applied to the vehicle,
- $\boldsymbol{\Omega}$  = the angular velocity of the vehicle with respect to an inertial reference system.

The equation relating  $\mathbf{P}$  and  $\mathbf{M}$  can be resolved into components in the vehicle's axis system if allowance is made for the variation of the direction of the axes with time:

$$\begin{aligned} \mathbf{M} &= \frac{d\mathbf{P}}{dt} = \frac{d}{dt} (P_x \mathbf{i} + P_y \mathbf{j} + P_z \mathbf{k}) \\ &= \frac{dP_x}{dt} \mathbf{i} + \frac{dP_y}{dt} \mathbf{j} + \frac{dP_z}{dt} \mathbf{k} + P_x \frac{d\mathbf{i}}{dt} + P_y \frac{d\mathbf{j}}{dt} + P_z \frac{d\mathbf{k}}{dt} \\ &= \frac{dP_x}{dt} \mathbf{i} + \frac{dP_y}{dt} \mathbf{j} + \frac{dP_z}{dt} \mathbf{k} \times \boldsymbol{\Omega} \times (P_x \mathbf{i} + P_y \mathbf{j} + P_z \mathbf{k}). \end{aligned} \quad (30)$$

Let

- $\varphi$  = roll angle
- $\theta$  = pitch angle
- $\psi$  = yaw angle;

then

$$\begin{aligned} \boldsymbol{\Omega} &= \varphi' \mathbf{i} + \theta' \mathbf{j} + \psi' \mathbf{k} \\ \boldsymbol{\Omega} \times \mathbf{i} &= \psi' \mathbf{j} - \theta' \mathbf{k} \\ \boldsymbol{\Omega} \times \mathbf{j} &= \varphi' \mathbf{k} - \psi' \mathbf{i} \\ \boldsymbol{\Omega} \times \mathbf{k} &= \theta' \mathbf{i} - \varphi' \mathbf{j}. \end{aligned} \quad (31)$$

Substituting (31) into (30) and equating components:

$$M_x = \frac{dP_x}{dt} - P_y \psi' + P_z \theta'$$

$$\begin{aligned}
 M_y &= \frac{dP_y}{dt} - P_z\varphi' + P_x\psi' \\
 M_z &= \frac{dP_z}{dt} - P_x\theta' + P_y\varphi'.
 \end{aligned}
 \tag{32}$$

Assuming that the principal axes of inertia are parallel to the chosen coordinate axes:

$$\begin{aligned}
 P_x &= I_{M1}\varphi', & \frac{dP_x}{dt} &= I_{M1}\varphi'' \\
 P_y &= I_{M2}\theta', & \frac{dP_y}{dt} &= I_{M2}\theta'' \\
 P_z &= I_{M3}\psi', & \frac{dP_z}{dt} &= I_{M3}\psi''.
 \end{aligned}
 \tag{33}$$

Substituting (33) into (32), the expressions for the moments applied to the vehicle become:

$$\begin{aligned}
 M_x &= I_{M1}\varphi'' - (I_{M2} - I_{M3})\theta'\psi' \\
 M_y &= I_{M2}\theta'' - (I_{M3} - I_{M1})\psi'\varphi' \\
 M_z &= I_{M3}\psi'' - (I_{M1} - I_{M2})\varphi'\theta'.
 \end{aligned}
 \tag{34}$$

The equations of motion of the flywheels will be set up in the same coordinate system.

The flywheel whose axis is parallel to the roll axis of the vehicle will be called the roll flywheel. Its angular velocity with respect to the vehicle will be designated  $\omega_1$ ; the constraint of its bearings will force it to have the same angular velocity as the vehicle in pitch and yaw equal respectively to  $\theta'$  and  $\psi'$ . Similar considerations apply to what may be called the pitch and yaw flywheels. The angular velocity of the pitch flywheel with respect to the vehicle is  $\omega_2$ ; that of the yaw flywheel,  $\omega_3$ . In tabular form:

Flywheel	Angular Velocity with Respect to Inertial Space in			Moment of Inertia in			Moment Applied to Flywheels		
	Roll	Pitch	Yaw	Roll	Pitch	Yaw	Roll	Pitch	Yaw
Roll	$\varphi' + \omega_1$	$\theta'$	$\psi'$	$I_{11}$	$I_{12}$	$I_{13}$	$M_{1r}$	$M_{1p}$	$M_{1y}$
Pitch	$\varphi'$	$\theta' + \omega_2$	$\psi'$	$I_{21}$	$I_{22}$	$I_{23}$	$M_{2r}$	$M_{2p}$	$M_{2y}$
Yaw	$\varphi'$	$\theta'$	$\psi' + \omega_3$	$I_{31}$	$I_{32}$	$I_{33}$	$M_{3r}$	$M_{3p}$	$M_{3y}$

By an exactly similar analysis as that gone through for the vehicle, the equations for the roll flywheel are:

$$\begin{aligned}
 M_{1r} &= I_{11}(\varphi'' + \omega_1') - (I_{12} - I_{13})\theta'\psi' \\
 M_{1p} &= I_{12}\theta'' - (I_{11} - I_{13})\psi'(\varphi' + \omega_1) \\
 M_{1y} &= I_{13}\psi'' - (I_{11} - I_{12})\varphi'(\varphi' + \omega_1)\theta'.
 \end{aligned}
 \tag{35x}$$

for the pitch flywheel,

$$\begin{aligned} M_{2x} &= I_{21}\varphi'' - (I_{22} - I_{23})(\theta' + \omega_2)\psi' \\ M_{2y} &= I_{22}(\theta'' + \omega_2') - (I_{23} - I_{21})\psi'\varphi' \\ M_{2z} &= I_{23}\psi'' - (I_{21} - I_{22})\varphi'(\theta' + \omega_2); \end{aligned} \quad (35y)$$

and for the yaw flywheel,

$$\begin{aligned} M_{3x} &= I_{31}\varphi'' - (I_{32} - I_{33})\theta'(\psi' + \omega_3) \\ M_{3y} &= I_{32}\theta'' - (I_{33} - I_{31})(\psi' + \omega_3)\varphi' \\ M_{3z} &= I_{33}(\psi'' + \omega_3') - (I_{31} - I_{32})\varphi'\theta'. \end{aligned} \quad (35z)$$

If the flywheels were free in space and the moments on the left-hand side of these equations were applied, the resulting change in motion of the flywheels would be given by the other side of these equations. On the other hand, if the motions are assigned, as is the case with the flywheels since they are constrained to have the same motion as the vehicle about two axes, the moments resulting from these motions can be computed. These computed moments, of course, will be the negative of the moments imposed on the vehicle by the flywheels, i.e.,

$$\begin{aligned} M_x &= -(M_{1x} + M_{2x} + M_{3x}) \\ M_y &= -(M_{1y} + M_{2y} + M_{3y}) \\ M_z &= -(M_{1z} + M_{2z} + M_{3z}). \end{aligned} \quad (36)$$

Substituting (35x), (35y), (35z), and (34) into (36) and rearranging terms,

$$\begin{aligned} I_{11}\omega_1' &= -I_{M1}\varphi'' + (I_{M2} - I_{M3})\theta'\psi' + (I_{22} - I_{23})\psi'\omega_2 + (I_{32} - I_{33})\theta'\omega_3 \\ I_{22}\omega_2' &= -I_{M2}\theta'' + (I_{M3} - I_{M1})\psi'\varphi' + (I_{33} - I_{31})\varphi'\omega_3 + (I_{13} - I_{11})\psi'\omega_1 \\ I_{33}\omega_3' &= -I_{M3}\psi'' + (I_{M1} - I_{M2})\varphi'\theta' + (I_{11} - I_{12})\theta'\omega_1 + (I_{21} - I_{22})\varphi'\omega_2. \end{aligned} \quad (37)$$

In writing Eq. (37), it is assumed that the moments of inertia of the vehicle include the moments of inertia of the flywheels. For instance,

$$I_{M3} \equiv I_{M3} + I_{13} + I_{23} + I_{33}.$$

A slight simplification occurs if the vehicle's yaw and pitch moments of inertia are assumed to be equal in the first equation of (37). The terms on the left-hand side of (37) are the moments applied to the flywheels to change their spin with respect to the vehicle, and these may be called the control moments.

These equations are exact, holding true for large angular velocities. The difficulty with them is that their application would require, in addition to nine sums, nine products to be taken in a computer in the vehicle. This would require much circuitry and thus power consumed in heating filaments of electron tubes. Furthermore, the results so obtained probably would be more accurate than is necessary.

Linearization of these equations is therefore indicated. The only quantity which is assumed to have nonzero steady-state values is the angular velocity\* of the vehicle,  $\theta$ .

\* The angular velocity of the pitch flywheel,  $\Omega_2$ , is assumed to have a zero steady-state value because the angular velocity of the vehicle,  $\theta$ , will be imparted to the satellite by the control rockets during the initial phase of the orbiting path.

The linearized equations are:

$$\begin{aligned} I_{11}\omega_1' &= -I_{M1}\varphi'' + (I_{22} - I_{33})\theta'_0\omega_1 \\ I_{22}\omega_2' &= -I_{M2}\theta'' \\ I_{33}\omega_3' &= -I_{M3}\psi'' + (I_{M1} - I_{M2})\theta'_0\varphi' + (I_{11} - I_{12})\theta'_0\omega_1. \end{aligned} \quad (38)$$

The number of additions has been reduced to four, and there remain no multiplications of variables except by constants.

In order that the vehicle may have a suitable response to a correction in altitude, some control proportional to the error and the time rate of change of error must be included in the computer. A control function accomplishing this could have the following form:

$$\begin{aligned} \frac{M_x}{I_{M1}} &= \frac{I_{11}\omega_1'}{I_{M1}} = 2\zeta_{\varphi}\omega_{\varphi}\varphi' + \omega_{\varphi}^2\varphi + \frac{I_{22} - I_{33}}{I_{M1}}\theta'_0\omega_1 \\ \frac{M_y}{I_{M2}} &= \frac{I_{22}\omega_2'}{I_{M2}} = 2\zeta_{\theta}\omega_{\theta}\theta' + \omega_{\theta}^2\theta \\ \frac{M_z}{I_{M3}} &= \frac{I_{33}\omega_3'}{I_{M3}} = 2\zeta_{\psi}\omega_{\psi}\psi' + \omega_{\psi}^2\psi + \frac{I_{11} - I_{12}}{I_{M3}}\theta'_0\omega_1. \end{aligned} \quad (39)$$

If each equation of (38) is divided by the moment of inertia of the vehicle used in that equation and (39) is substituted into (38), the motion of the vehicle is seen to be described by a second order system in each degree of freedom:

$$\begin{aligned} \varphi'' + 2\zeta_{\varphi}\omega_{\varphi}\varphi' + \omega_{\varphi}^2\varphi &= 0 \\ \theta'' + 2\zeta_{\theta}\omega_{\theta}\theta' + \omega_{\theta}^2\theta &= 0 \\ \psi'' + 2\zeta_{\psi}\omega_{\psi}\psi' + \omega_{\psi}^2\psi &= 0. \end{aligned}$$

In each equation,  $1/\zeta_i\omega_i$  is the response time,  $\omega_i$  is the radian frequency with which the system would oscillate if there were no damping, and  $\zeta_i$  is the damping ratio.

The damping ratio chosen is 0.8, and for the lack of any suitable criterion, a response time of 1 min was chosen as being an easily realizable quantity requiring little power, since it is probable that no sharp disturbances will be felt by the satellite. Hence,

$$\omega_i = \frac{1}{0.8 \times 60} = 0.021 \text{ rad/sec.}$$

The moments of inertia of the 1000-lb-payload satellite vehicle are:

$$\begin{aligned} I_{M1} &= 111 \text{ slug ft}^2 \\ I_{M2} &= I_M = 1075 \text{ slug ft}^2. \end{aligned}$$

The ratio of the moments of inertia of the roll and pitch flywheels about their spin axes is taken in the same manner as the ratio of the vehicle's moment of inertia in roll to its moment of inertia in pitch or yaw, i.e.,

$$\frac{I_{11}}{I_{22}} = \frac{I_{M1}}{I_{M2}} = \frac{I_{M1}}{I_{M3}} \doteq 10.$$

---

The absolute values arbitrarily adopted are:

$$\begin{aligned}I_{11} &= 1 \text{ slug ft}^2 \\I_{22} &= I_{33} = 10 \text{ slug ft}^2.\end{aligned}$$

The moments applied to the flywheels, then, are:

$$\begin{aligned}M_x &= 3.73\varphi' + 4.90 \times 10^{-2}\varphi + 6.31 \times 10^{-3}\omega_3 \\M_y &= 36.2\theta' + 0.475\theta \\M_z &= 36.2\psi' + 0.475\psi + 6.31 \times 10^{-4}\omega_1.\end{aligned}\tag{40}$$

For the same damping ratio, the coefficients of  $\varphi'$ ,  $\theta'$ , and  $\psi'$  will vary inversely as the required response time. That is, if the response were  $\frac{1}{10}$  min, the coefficients would be ten times larger. Moreover, the coefficients of  $\varphi$ ,  $\theta$ , and  $\psi$  will vary inversely as the square root of the response time.

The moments of inertia of the control flywheels about axes perpendicular to their axes of symmetry have been taken as half their moments of inertia about their axis of symmetry. This is fairly accurate for something built to the proportions of a hoop, which is the most desirable shape for the flywheels because it gives the maximum moment of inertia for a given mass.

## APPENDIX V

### AUXILIARY POWERPLANT ANALYSIS AND VARIATIONS

The purpose of this appendix is to examine in greater detail certain aspects of the two powerplants discussed in the body of the report, to evaluate several interesting variations thereof, and to consider other possible types of powerplants as well as other fuel sources.

In addition to the various familiar ways of obtaining electrical energy from conventional devices, there are also a number of other means, of unconventional nature, for producing electricity. Figure 52 illustrates many of these power-producing processes.

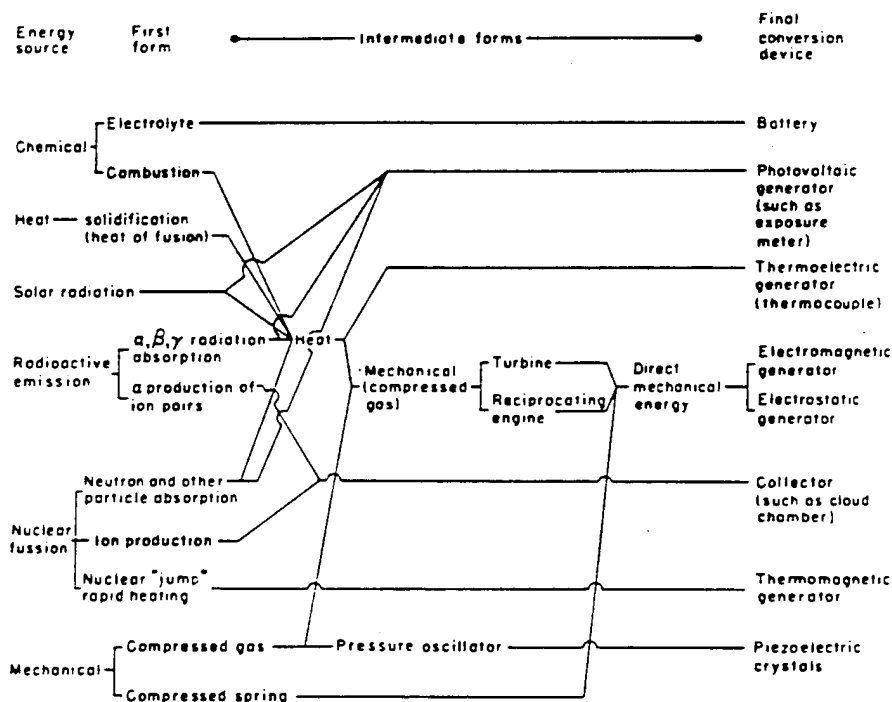

Fig. 52—Possible processes for obtaining satellite electrical supply

Since one of the most severe constraints on the satellite's generating plant is that it must produce the required power—5000 kw-hr for the 1-year period—within an over-all weight limitation for both fuel and machinery of 250 lb, it can readily be shown that on the basis of fuel weight alone, most stored forms of energy will be unsuitable for this application. Even where the most economical conversion device is considered, all forms

---

of energy, except nuclear energy and solar heat, require fuel weights far in excess of acceptable values for the satellite.

Review of Fig. 52 shows that solar radiation, radioactive emission, and nuclear fission can be used to produce heat energy for subsequent conversion to electrical energy. Also, any of the three could operate a photovoltaic generator. The two nuclear fission reactions,\* which could conceivably be employed with some form of a collector, such as a cloud chamber, to produce electricity directly. Another means for producing electrical energy from nuclear fission is a thermomagnetic generator.

The ion collector and photovoltaic generator will be dropped from further consideration because of a complete lack of knowledge regarding their capabilities of producing power in appreciable quantities. All the remaining systems—electromechanical, electrostatic, thermoelectric, and thermomagnetic generators—employ heat energy and thus can be classified as heat engines.

#### THE HEAT ENGINE

The term heat engine as used here is defined as any system employing heat as an energy source and producing useful work in the form of either mechanical energy or electricity. A heat engine thus incorporates a heat source and a device for extracting useful work from the heat energy. In addition, there must always be a heat sink, or cooler, in the system; although this is a well-known postulate of thermodynamics, it is desirable to restate it here because of its especial pertinence to the satellite.

Thermodynamics also furnishes the knowledge of the maximum efficiency of any heat engine, namely, that of the ideal Carnot cycle. This can be stated in the following form:

$$\eta_{th} = \frac{Q_s - Q_c}{Q_s} \quad (41a)$$

where  $\eta_{th}$  is the maximum efficiency of the heat engine,  $Q_s$  is the heat supplied by the heat source, and  $Q_c$  is the heat removed by the heat sink. A direct result of this theorem is an alternate form:

$$\eta_{th} = \frac{T_s - T_c}{T_s} \quad (41b)$$

where  $T_s$  and  $T_c$  are the respective temperatures in °R of the heat source and sink.

An actual heat engine has a lower efficiency than the ideal one because losses occur in the work-extraction device. Very few heat engines used for producing electricity, particularly in small sizes, operate at an over-all efficiency of more than 10 per cent.

It is thus apparent that the problem of supplying 5000 kw-hr of electrical energy has devolved not only to that of supplying ten or more times this amount of heat energy, but also to that of dissipating nearly as much heat as is supplied. Consequently, some further remarks about the energy source and the heat sink are in order.

---

\* For example, alpha particles are quite heavy, are positively charged, and lose energy by the formation of ion pairs as they pass through a material. The ion pairs are formed by excitation of bound electrons in the material, which are stripped off the atoms and thereby form ions.

---

## THE ENERGY SOURCE

Major consideration must be given to the nuclear source of energy. This could be either a fast reactor of uranium 235 or a radioisotope having the appropriate half life.

The nuclear reactor has the advantage of a long lifetime and thus could motivate the satellite equipment as long as the vehicle remained aloft in a useful capacity. Further, the reactor can be tested on the ground and then "shut down" by means of controls until time for use in the vehicle, thereby reducing handling problems. Two main deterrents are seen in the use of the reactor. The first is, of course, the strategic nature of  $U^{235}$ . The second is the inherent difficulty of controlling the reactor at high temperatures. Reactor-energized powerplants have been operated at temperatures low enough so that water can be used as a moderator. Unfortunately, such a low-temperature regime is of little value in the satellite because temperatures required will be of the order of 1000°F or higher; it could well be that it would be impossible to control a reactor at such temperatures. The use of a radioisotope at these temperatures, however, is believed to be a straightforward problem, since they can be used in a molten form or alloyed with metals of the appropriate (higher) melting points.

As stated in the body of the report, the radioactive fuels would probably be ruthenium 106 or cerium 144, both beta emitters, which have half lives of 1 year and 275 days, respectively. A short-period satellite might conceivably use strontium 89, which has a half life of 55 days. The radioactive fuels have the advantage of being by-products of nuclear piles and thus have a lower military priority than  $U^{235}$ . There appears to be an ample supply on hand in pile wastes, although a complexity exists in the handling and separation of these fuels from the waste products. Further, the exponential decay cannot be halted; every day lost between separation of the fuels and their use in the satellite causes an additional depletion of the separated supply.

Because of the collection and utilization problems, solar energy\* will be discussed later as a specific energy converter, rather than as a separate, packageable energy source.

## THE HEAT SINK

It has been noted that the over-all efficiency and even feasibility of the satellite's auxiliary powerplant depend on the temperature at which excess heat must be dissipated, that the normal difficulties encountered in disposing of waste heat from the engine are accentuated in the satellite, and that radiation from the skin of the vehicle must be used since there is no appreciable atmosphere and there are no convection currents to carry away this waste energy.

---

\* In addition to solar heat, a further supply of energy exists in the upper atmosphere—a by-product of the sun's radiation in the form of dissociated atoms of oxygen and nitrogen, which are present at altitudes greater than 60 mi above the earth. Collecting a number of these nascent atoms, such that their concentration in a given volume is increased (by compressing the ambient air), enhances the probability of a three-body collision and thus the release of potential energy of association, which is of the order of 4 to 7 kcal/mole. However, at the altitudes where the satellite has a useful duration, it is probable that not enough atoms can be collected per unit time to produce a useful amount of energy.



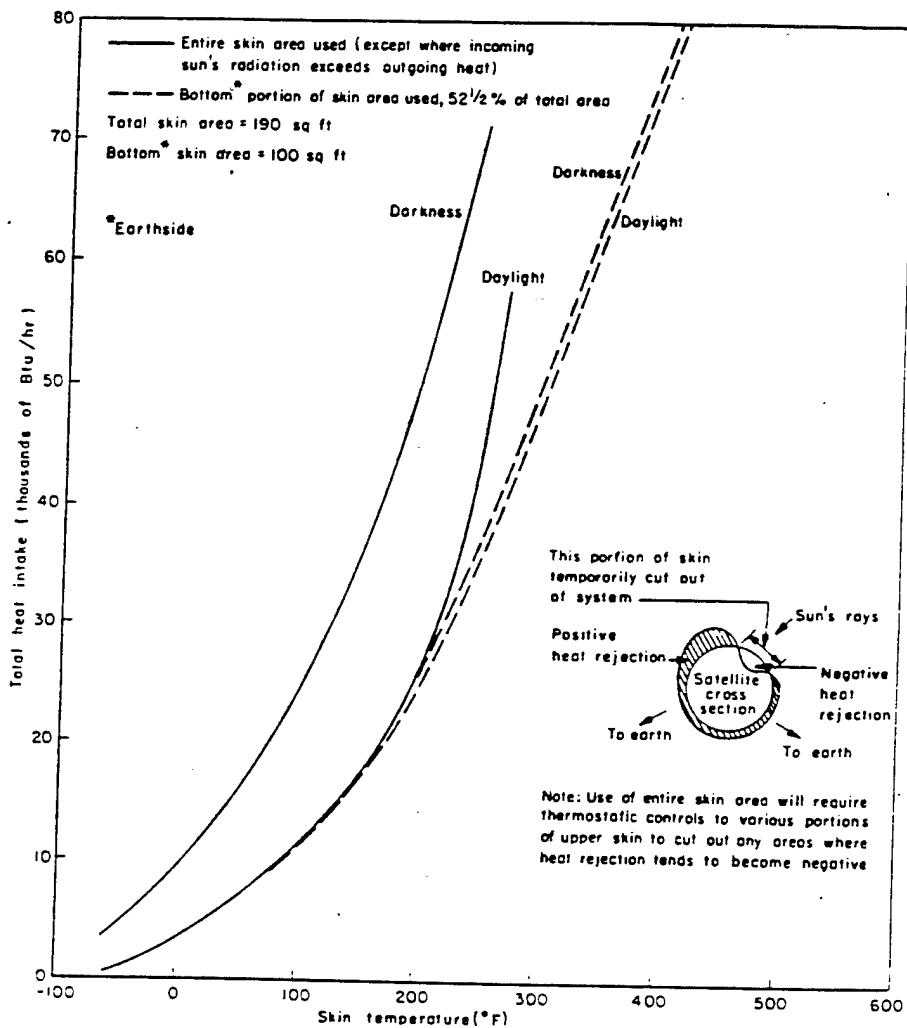

Fig. 53—Total heat that can be dissipated by radiation from skin of 1000-lb-payload satellite vs temperature of skin for two cases

Thus a limit is set on the total amount of heat that can be dissipated at any given temperature. Further, the lower the skin temperature, the less the over-all amount of waste heat that can be accommodated, as shown in Fig. 53 where the total amount of heat that can be dissipated by radiation from the 1000-lb-payload satellite is given as a function of skin temperature for both darkness and full sunlight cases\* when (1) the entire satellite skin is used and (2) when the lower half only (toward the earth) is employed. Those sections of the satellite skin having negative heat rejection—i.e., receiv-

\* The 350-mi-orbital-altitude satellite alternates between 45-min periods of darkness and sunlight.

---

ing more heat from the sun than is being reradiated—are assumed to be cut out of the system. Study of the figure reveals that for the daylight case and skin temperatures of about 200°F or lower, virtually no benefit accrues in using the upper half of the satellite skin. Rather, if the powerplant operates continuously at constant output, it is advantageous to utilize only the bottom portion of the satellite surface where the conditions for heat rejection are nearly constant.

For a given amount of power required, there is a unique value of the skin temperature which allows production of this power at greatest efficiency. If the energy converter part of the heat engine is too inefficient or if the power production requirements are too high, then no solution exists and the powerplant cannot feasibly produce the power required of it.

As an illustration, consider the 500-watt gas engine, described in Section IV (page 59), where 20,000 Btu/hr are dissipated at a skin temperature of 160°F by using the earth-side half of the satellite skin under full sunlight. If a 1500-watt output powerplant of a similar type is demanded, 60,000 Btu/hr would have to be disposed of *if the same efficiency could be maintained*. It can be seen from Fig. 53 that 340°F, corresponding to a bottom cycle temperature of 380°F, is now the minimum allowable skin temperature. The thermal efficiency of the cycle with this assumed bottom temperature is reduced from 58.8 per cent to 47.5 per cent, which means that 23.6 per cent more heat input (and thus heat disposal) is necessary. Corresponding to 380°F skin temperature and 420°F bottom cycle temperature, 74,000 Btu/hr now have to be dissipated. Carrying this iterative process to a solution yields a skin temperature of 400°F (a bottom cycle temperature of 440°F), and 80,500 Btu/hr have to be dissipated—one-third more than would be indicated on an equivalent efficiency basis.

It is readily seen that a minor change in the engine-cycle efficiency, or an increase to, say, 2500-watt powerplant, would result in a low cycle temperature requirement incompatible with the heat to be dissipated. The examples of increased power are presented for illustrative purposes only and to indicate the rather sensitive relationships involved.

The mechanisms by which the waste heat is transferred from the 500-watt gas engine to the lower skin of the satellite have been described briefly in the text. The capillary tubes, through which the NaK solution is force-fed from the cold zone of the engine to the skin, are fabricated from 2S aluminum; a tube wall thickness of 0.005 in. is adequate for the 800 psi pressure. The 400 ft of tubing weighs 8 lb, and the NaK solution, 2 lb. The 0.002-in. copper flashing, installed between the tubes and the heat-radiating part of the inner skin to facilitate heat conduction normal to the tubes, weighs about 10 lb and causes an average temperature rise of 5°F from the skin to the tubes.

Circulating the NaK through the tubes at 10 ft/sec velocity requires a 10.3-watt pump weighing about 2 lb. At this flow rate, the temperature rise through the tubes is 20°F. A further temperature gradient of about 15°F is necessary between the NaK and the cold portion of the engine cylinder. Thus the over-all temperature rise between the skin and the engine cylinder is 40°F, giving the low-end cycle temperature of 200°F. This temperature rise is accomplished with a 25-lb cooling system, including, in addition to the aforementioned items, 2 lb of valves and fittings and 1 lb of heat-conducting glue for cementing the tubes to the copper sheath.

---

During darkness, the heat-rejection system is more efficient, being about  $10^{\circ}$  colder than the full sunlight value. This means about a  $13^{\circ}\text{F}$  drop in temperature because the cycle efficiency is simultaneously improved, yielding a skin temperature of  $147^{\circ}\text{F}$  and a minimum temperature of  $152^{\circ}\text{F}$  in the tubes; these are well above the  $65^{\circ}\text{F}$  melting point of the NaK.

### THE GAS ENGINE WITH A BATTERY

At this point it is desirable to digress to determine if any improvement can be gained by adding a battery in the cycle. During periods of darkness, the electrical system remains on, but no pictures are being transmitted. Hence the nighttime electrical power requirements are about 40 per cent (200 watts) of those during the daytime. By assuming that 346 watts and 354 watts, respectively, are produced during alternate 45-min day and night periods, it can be shown that the system requires a 24-volt, 4.75-amp-hr battery which, by present aircraft standards, would weigh 10.7 lb. The appropriate engine would then be about 70 per cent as large as that for the system without such a battery, and the corresponding heat input would be roughly two-thirds; the corresponding skin temperatures would be  $100^{\circ}\text{F}$  during the "day" and  $90^{\circ}\text{F}$  at "night."

Thus the expedient of adding a small storage battery to the system has interesting possibilities, not only for the gas-cycle engine, but also for the vapor-cycle engine. Tending to counterbalance the potential gains are the attendant difficulties in developing a battery for operation in the satellite's environment for a year; however, there are some new types of batteries—nickel-cadmium and silver-alkaline—which might suffice. This problem certainly warrants further investigation.

### THE SOLAR POWERPLANT

The possibility of utilizing solar energy and thus obviating the employment of a nuclear fuel is intriguing. The solar powerplant system, per se, is visualized as being comprised of one of the previously described heat engine-generator-cooling systems in combination with appropriate means both for collecting the sun's heat and for storing a portion thereof for nighttime operation.

The principal difficulty in harnessing the sun's energy lies in focusing its rays on a receiver, for the collection device is more complex than would appear by casual observation. Reference to Fig. 54 reveals that collection of the sun's heat directly from the satellite skin is unsuitable. For example, if the collection temperature were  $240^{\circ}\text{F}$  (only  $40^{\circ}\text{F}$  above the *bottom* cycle temperature and therefore obviously impractical), 14,000 Btu/hr would be available to the 1000-lb-payload satellite in full sunlight; this is the maximum amount of energy which could be collected directly, yet it is still less than half of that which would be needed if the collection temperature were  $1300^{\circ}\text{F}$  ( $100^{\circ}$  above the appropriate top cycle temperature). Consider now the reduction of the skin's collection area to just that directly under the sun's rays. At  $540^{\circ}\text{F}$ , still too low to be commensurate with a reasonable top temperature, the heat received is even now only 2500 Btu/hr, or one-tenth of the required energy.

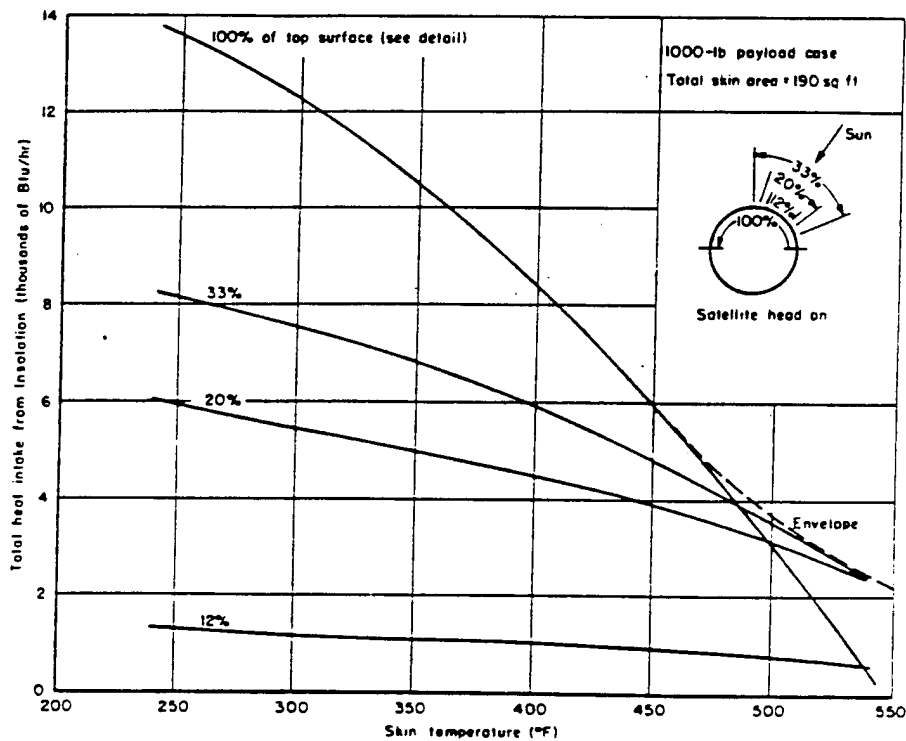

Fig. 54—Insulation heat intake as a function of collection area and skin temperature

If a lens could be built into the satellite's hull such that the sun's rays could be focused on a receiver of appropriate dimensions, then a more reasonable collection temperature could be realized. By focusing the rays through 80 ft<sup>2</sup> of projected area of lens material, virtually the entire projected area\* of the satellite, upon  $\frac{1}{3}$  ft<sup>2</sup> of black plate, 28,000 Btu/hr could be collected at a temperature of 1220°F. If 20,000 Btu/hr are used directly for the sunlit operation and 8000 Btu/hr are stored for operation during the 45-min dark periods, the engine should run continuously. Accumulation of 8000 Btu/hr  $\times$  45 min = 6000 Btu to be stored; this can be accomplished by use of 36 lb of aluminum, whose melting point is 1220°F and heat of fusion is 167.5 Btu/lb.

Under nighttime conditions, the engine would be operating under lowered top and bottom cycle temperatures, and its efficiency would therefore be higher than in daytime. The changing requirements would have little effect on the engine and could be handled without difficulty by an engine governor.

However, the arrangement whereby all available solar energy is converted into power as it is received, but part of the power is stored in a battery, means not only that the heat

\* The projected area of the portion of the final satellite vehicle having a skin is 60 ft<sup>2</sup>. By incorporating the lens material in part of the afterend of this final stage (projected area = 30 ft<sup>2</sup>), the total of 80 ft<sup>2</sup> can be obtained.

---

engine has to be shut down on alternate 45 min, but also that the engine itself would have to be 40 per cent larger. This arrangement is unsuitable from the standpoint of reliability if not of weight.

As stated, the predominant difficulty in a solar powerplant is that of devising a transparent lens which will focus on the receiver and still be able to withstand the environment during the satellite-boosting period. Development of a satisfactory lens structure is the only real impediment to the use of solar energy. A serrated-type lens would be desirable since it could be formed around any arbitrary shape and thus could be built into the satellite skin. Further, a fixed focus arrangement could be employed because the vehicle itself could always be orientated toward the sun by using a simple sun-seeker to operate the pitch and roll controls; in this case, the television scanning system would have to be moved in relation to the vehicle so that it would point in proper fashion toward the earth.

If any significant portion of the satellite skin is a transparent substance, it must be able to withstand the temperatures and the temperature stresses experienced during the satellite's ascent. Glass might be made to conform to such requirements but would be quite heavy in relation to the 0.20-in. stainless steel presently intended for the satellite skin. Use of a Vycor\* lens,  $\frac{5}{16}$ -in. thick, would require an over-all powerplant weight increase of 1000 lb. Another problem is that of rearranging the fuel tanks, etc., within the vehicle so that these components will not interfere with the directed rays of the sun.

For these reasons, as well as because of the more promising possibilities of the nuclear fuels, further study of the use of solar energy is not contemplated at this time.

#### THE THERMOELECTRIC GENERATOR

The thermoelectric generator is a thermocouple with the hot junction at the heat source and the cold junction at the heat sink. The efficiency of energy conversion is about 4 per cent at best. By using the cycle temperatures corresponding to those of the gas engine, a 2.4 per cent over-all efficiency results; in this case, 20 kw of energy must be dissipated, requiring a skin temperature of over 400°F. Thus an output of approximately 100 watts is all that can be expected from this converter. Actually, a 4 per cent conversion efficiency is based on a combination of metals having a tendency to diffuse into one another, resulting in a shortened lifetime. If a more durable combination is used, the efficiencies are even less, and the foregoing remarks indicate that not much useful power can be anticipated.

#### THE THERMOMAGNETIC GENERATOR

The thermomagnetic generator consists of a closed magnetic circuit having a definite polarity (fixed magnetomotive force such as that supplied by a permanent magnet) and a means for varying the magnetic flux in the circuit. An example of such a device is a material having a large magnetic permeability change with temperature variation (e.g.,

---

\* Vycor, a relatively new product of the Dow-Corning Glass Co., similar in characteristics to quartz, is used, for example, to view engine combustion processes.

---

soft iron shifting from a face-centered to a body-centered crystal structure) which is alternately heated and cooled. A solenoidal coil is placed about the magnetic circuit so that the changing flux produces an electrical current.

One proposal for a thermomagnetic generator makes use of a fission "jump" process. The soft iron core of the magnetic circuit and the rotating block are impregnated with fissionable material. When the block is rotated into proximity with the iron core, the increase in neutrons causes a sudden input of heat into the iron core and a change in its permeability. For the remainder of the rotating cycle, cooling is effected by a circulating heat-transfer fluid.

The input of heat causes surges of electrical energy similar to the output of a half-wave rectifier. The only moving parts of the proposed thermomagnetic generator are the wheel containing the fission block, the wheel's motor drive, and the electrically operated circulating pump for the heat-transfer fluid.

To increase the sharpness of the heat pulses and thus the efficiency of the cycle, it may be possible to introduce a quenching device, such as an adiabatic demagnetization process; this device would produce an alternating current.

The thermomagnetic generator will have to be analyzed further, not only to determine its weight, size, and power characteristics, but also to study the possible structural deterioration which might be caused by neutron bombardment.

---

## APPENDIX VI

### A SIMPLE FAILURE MODEL FOR LONG-LIFE TUBES

#### INTRODUCTORY REMARKS

It is desired to estimate the approximate level of electronic reliability to be expected in the satellite vehicle if performance equivalent to that of the *best* present-day electronic equipment manufacture and use were realized. To do this requires data for the unattended operation of very reliable equipment over a period of time comparable with that required of the satellite.

The data most nearly meeting both this requirement and that of providing a statistically large sample are presented in the text under "Bell Telephone Equipment Data" on page 67. These data, which represent tubes in continuous use in telephone bay equipment, indicate a tube reliability several orders of magnitude higher than any achieved elsewhere. Since the tubes were inspected at 3-month intervals and the marginal tubes replaced, the data cannot be applied directly to the reliability prediction for a year's operation of the satellite; however, a model based on the data, and reasonably descriptive of the underlying phenomena, may be used for this purpose. Such a model is described subsequently.

The model is based on the idea that tubes, on inspection, are rejected or accepted on the basis of certain measured physical characteristics (plate current, grid voltage, transconductance, etc.) lying within predetermined limits. These limits are ascertained from long experience with the tube and from familiarity with its required functions. Thus, to be realistic, a model should consider several tube characteristics, each of which has imposed on it a set of inspection selection limits. This is not possible with the present data, however, since the rejections are not separated by type. Therefore, a single variable is used. Although the resulting model is an oversimplification, it provides an estimate which is probably correct in order of magnitude.

#### FAILURE MODEL

1. Consider a characteristic  $x$  of tubes which is measured quarterly. A tube is rejected if its  $x > x_0$  or  $x < -x_0$ ; i.e.,  $x$  is used as an acceptance criterion, and the acceptance interval\* is  $(-x_0, x_0)$ . Assume  $x$  is normally distributed and is represented in units such that the mean is zero and the standard deviation is  $\sigma = 1$ . Tube *failure* during operation is determined by  $x$ 's lying outside the interval  $(-x_f, x_f)$ . Of course,  $x_0 < x_f$ .
2. Six thousand tubes are inspected quarterly over a period of a year. At each inspection, an average of 90 tubes (1.5 per cent) is rejected as being outside the acceptance

---

\* The concepts "acceptance interval" and "failure interval" are part of the model and are not to be considered as included in the data.

interval. These are replaced by good tubes. During each period,  $n_0$  tubes are found to lie outside the failure interval  $(-x_f, x_f)$ , i.e., no tubes have failed.

3. From (2) it is seen that, concerning *selected* tubes operating over a 3-month period, four samples of six thousand observations each have been taken in which no failures have occurred. Since  $n$  is large, the variable  $(x - nq)/\sqrt{np(1-q)}$  has a distribution which approximates the normal distribution with mean zero and standard deviation one; here  $x$  is the observed number of tube failures,  $n$  is the number of trials, and  $q$  is the probability of tube failure during the 3 months of operation. Further, since 95 per cent of the values of a normal variate lie within  $\pm 2\sigma$  of the mean, and since  $x = 0$  and  $n = 24,000$ ,

$$\left| \frac{24000q}{\sqrt{24000q(1-q)}} \leq 2 \right|,$$

or  $q < 1/6000$ , with 95 per cent confidence.

4. Consider the group of tubes after selection which are just starting operation during the first 3-month period. From the assumption of a normal distribution of the characteristic  $x$  for unselected tubes, the tubes after selection will exhibit a distribution similar to the normal, but truncated in that the tails containing the  $x$ 's lying outside the interval  $(-x_0, x_0)$  have been folded back into the body (bad tubes are replaced by good ones):

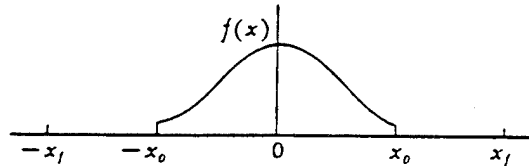

The figure is somewhat exaggerated, as the tails which have been folded back represent only 1.5 per cent of the total. During the 3 months of operation, the  $x$ 's diffuse in some manner (i.e., the tube characteristics deteriorate) such that at the end of that time, 1.5 per cent of the tubes have an  $x$  lying outside the interval  $(-x_0, x_0)$  but none has an  $x$  lying outside  $(-x_f, x_f)$ . If it is assumed that the distribution of the  $x$ 's at the end of the 3-month period is approximately normal with a mean of zero and  $\sigma = 1$ —this is reasonable since the fraction of  $x$ 's lying outside  $(-x_0, x_0)$  is the same as that in the original unselected group, which was already assumed normal in (1)—then the limits  $x_0$  and  $x_f$  must be such that

$$1 - \int_{-x_0}^{x_0} f(x) dx = 0.015$$

$$1 - \int_{-x_f}^{x_f} f(x) dx < \frac{1}{6000} = 0.000167. \quad (42)$$

This follows from (2) and (3). From these expressions, it is found that  $x_0 = 2.43$  and that  $x_f \geq 3.76$ ; the lower limit 3.76 leads to the most failures and will be used in the following argument.

5. Actually, the tubes lying outside the acceptance criterion were replaced at the end



---

of the first 3 months' operation (and, indeed, at the end of each subsequent 3-month period). The question now is what might have happened to the group of tubes if no replacements had been made for a year. Evidently the tube characteristics would continue to diffuse in some unknown manner, but in such a way that no more than 1.5 per cent of the  $x$ 's would pass outside the fixed interval  $(-x_0, x_0)$  during any 3-month period. The vital question is, of course, what fraction of those  $x$ 's passing outside  $(-x_0, x_0)$  also pass outside the interval  $(-x_f, x_f)$  before the year is up. The upper limit for this fraction is  $\frac{3}{4}$  and would obtain if each tube having an  $x$  outside  $(-x_0, x_0)$  at the end of one quarter would fail during the next quarter; this would result in 4.5 per cent failures at the end of the year. The  $x$ -distribution for this situation would have an extraordinarily high ratio of  $x$ 's beyond the range  $(-x_f, x_f)$  as compared with those in the intervals  $(-x_f, -x_0)$  and  $(x_0, x_f)$  and is not representative of the smooth spreading of the characteristic  $x$  which would appear to take place in slowly changing long-lived tubes. A more reasonable assumption is that the end distribution can again be represented by a smooth normal curve with mean zero and standard deviation such that the proportion of  $x$ 's lying outside  $(-x_0, x_0)$  is 6 per cent of the total. The  $\sigma$  so determined is  $\sigma = 1.29$ . From this, the expected fraction of tubes lying outside  $(-x_f, x_f)$  at the end of a year is 0.36 per cent.

6. Applying this to a group of 100 tubes (e.g., satellite equipment), the expected number of failures is 0.36, and the probability of no failure is  $e^{-0.36}$ , or 70 per cent for 1 year's operation.\*

---

\* From the Poisson approximation to the binomial distribution: When the expected number of occurrences,  $\epsilon$ , is small compared with the number of trials, the probability of no occurrence is  $e^{-\epsilon}$ .

---

## REFERENCES

1. Greenfield, S. M., and W. W. Kellogg. *Inquiry into the Feasibility of Weather Reconnaissance from a Satellite Vehicle*. Project RAND, The RAND Corporation, report R-218, April 1951 (Secret).
2. Kecskemeti, Paul. *The Satellite Vehicle: Political and Psychological Problems*. Project RAND, The RAND Corporation, Research Memorandum RM-567, October 4, 1950 (Secret).
3. Krueger, R. W., G. Griminger, and E. Tieman. *Flight Mechanics of a Satellite Rocket*. Project RAND, The Douglas Aircraft Company, Inc., Report RA-15021, February 1, 1947 (Secret).
4. Krueger, R. W., and G. Griminger. *Aerodynamics, Gas Dynamics, and Heat Transfer Problems of a Satellite Rocket*. Project RAND, The Douglas Aircraft Company, Inc., Report RA-15022, February 1, 1947 (Secret).
5. Griminger, G., *Analysis of Temperature, Pressure, and Density of the Atmosphere Extending to Extreme Altitudes*. Project RAND, The Douglas Aircraft Company, Inc., Report RA-15023, February 1, 1947.
6. Krieger, F. J., *Theoretical Characteristics of Several Liquid Propellant Systems*, Project RAND, The Douglas Aircraft Company, Inc., Report RA-15024, February 1, 1947 (Confidential).
7. Frick, R. H., *Stability and Control of a Satellite Rocket*, Project RAND, The Douglas Aircraft Company, Inc., Report RA-15025, February 1, 1947 (Secret).
8. Clement, G. H., *Structural and Weight Studies of a Satellite Rocket*. Project RAND, The Douglas Aircraft Company, Inc., Report RA-15026, February 1, 1947 (Secret).
9. Crum, J. O., and S. L. Gendler, *Satellite Rocket Powerplant*. Project RAND, The Douglas Aircraft Company, Inc., Report RA-15027, February 1, 1947 (Secret).
10. Bailey, D. K., and A. S. Mengel, *Communication and Observation Problems of a Satellite*. Project RAND, The Douglas Aircraft Company, Inc., Report RA-15028, February 1, 1947 (Secret).
11. Lipp, J. E., and D. K. Bailey, *Study of Launching Sites for a Satellite Projectile*. Project RAND, The Douglas Aircraft Company, Inc., Report RA-15029, February 1, 1947 (Secret).
12. Gunning, J. H., *Cost Estimate of an Experimental Satellite Program*. Project RAND, The Douglas Aircraft Company, Inc., Report RA-15030, February 1, 1947 (Secret).
13. Lipp, J. E., *Proposed Type Specification for an Experimental Satellite*, Project RAND, The Douglas Aircraft Company, Inc., Report RA-15031, February 1, 1947 (Secret).
14. Lipp, J. E., *Reference Papers Relating to a Satellite Study*, Project RAND, The Douglas Aircraft Company, Inc., Report RA-15032, February 1, 1947 (Secret).
15. Dickinson, W. E., *The NAA Model 1 Electromagnetic Accelerometer*, North American Aviation, Inc., Report AL-375, December 1, 1947 (Secret).
16. Brown, F. W., and M. A. Greenfield. *Analysis of Feasibility of Long-Range Guidance Systems*. North American Aviation, Inc., Report AL-349, November 1, 1947 (Secret).
17. Bieber, C. F., and H. L. Clark, *The Thermal Discontinuity at the Horizon Observed from High Altitudes*, Naval Research Laboratory, NRL Report No. 3529, September 12, 1949 (Confidential).

- 
18. Medina, Pedro C., *High Altitude Test Vehicle Summary Report*. Glenn L. Martin Company, Eng. Report 2666, June, 1947.
  19. Alvarez, L. W., *Notes on the Polonium Engine*. Project RAND, The RAND Corporation, Research Memorandum RM-2, April 24, 1946.
  20. Goodman, Clark, *et al.*, *Science and Engineering of Nuclear Power*, Addison-Wesley Press, Inc., Cambridge, Mass., 1947.
  21. Seaborg, G. T., and I. Perlman, "Table of Isotopes," *Rev. Modern Physics*, Vol. 20, No. 4, October, 1948, pp. 585-667.
  22. Rinia, H., and F. K. duPré, "Air Engines," *Philips Technical Review*, Research Laboratory of N. V. Philips' Gloeilampenfabrieken, Eindhoven, Holland, Vol. 8, No. 5, May, 1946, pp. 129-136.
  23. de Brey, H., H. Rinia, and F. L. van Weenan, "Fundamental Development of the Philips Air Engine," *Philips Technical Review*, Research Laboratory of N. V. Philips' Gloeilampenfabrieken, Eindhoven, Holland, Vol. 9, No. 4, 1947, pp. 97-104.
  24. van Weenan, F. L., "The Construction of the Philips Air Engine," *Philips Technical Review*, Research Laboratory of N. V. Philips' Gloeilampenfabrieken, Eindhoven, Holland, Vol. 9, No. 5, 1947, pp. 126-134.
  25. Green, E. I., "Dependable Components," *Proc. of Symposium, Improved Quality Electronic Components*, Washington, D.C., May 9, 10, 11, 1950, p. 93. (Distributed by Trielectro Company, 1 Thomas Circle, Washington 5, D.C.)
  26. Wilson, I. R., "Bell System," *Electron Tubes for Instrumentation and Industrial Use*, American Institute of Electrical Engineers, December, 1948, p. 65.
  27. Rich, E. S., and N. H. Taylor, "Component Failures Analysis in Computers," *Proc. of Symposium, Improved Quality Electronic Components*, Washington, D.C., May 9, 10, 11, 1950, p. 22. (Distributed by Trielectro Company, 1 Thomas Circle, Washington 5, D.C.)
  28. Banks, C. R., "Aeronautical Radio, Inc.," *Electron Tubes for Instrumentation and Industrial Use*, American Institute of Electrical Engineers, December, 1948, p. 47.
  29. Banks, C. R., "Reliability in Airborne Electronic Equipment," *Proc. of Symposium, Improved Quality Electronic Components*, Washington, D.C., May 9, 10, 11, 1950, p. 19. (Distributed by Trielectro Company, 1 Thomas Circle, Washington 5, D.C.)
  30. Gilbert, I. I., "A Submarine Cable with Submerged Repeaters," *Bell System Tech. J.*, January, 1951, p. 65.
  31. Frick, R. H., S. H. Browne, W. E. Frye, F. P. Forbath, J. J. Gilvarry, R. P. Isaacs, and E. V. Stearns, *Long-Range Surface-to-Surface Rocket and Ramjet Missiles—Guidance and Control*, Project RAND, The RAND Corporation, Report R-178, May 1, 1950 (Secret).
  32. Martin, K. I., and R. R. Brown, *Long-Range Surface-to-Surface Rocket and Ramjet Missiles—Flight Mechanics*, Project RAND, The RAND Corporation, Report R-179, May 1, 1950 (Secret).
  33. Gendler, S. L., R. M. Salter, L. P. Holliday, and H. A. Koch, *Long-Range Surface-to-Surface Rocket and Ramjet Missiles—Propulsion and Fuels*, Project RAND, The RAND Corporation, Report R-180, May 1, 1950 (Secret).
  34. Williams, E. P., L. W. Dhanes, J. H. Huntzicker, R. J. Lew, H. A. Lieske, L. L. Moore, and G. B. W. Young, *Long-Range Surface-to-Surface Rocket and Ramjet Missiles—Aerodynamics*, Project RAND, The RAND Corporation, Report R-181, May 1, 1950 (Secret).

- 
35. Davies, M. E., C. R. Culp, and T. P. Higgins, *Long-Range Surface-to-Surface Rocket and Ramjet Missiles—Structures and Weights*, Project RAND, The RAND Corporation, Report R-182, May 1, 1950 (Secret).
  36. Grimmingen, G., *The Aerodynamics of the Satellite Rocket*, Project RAND, The RAND Corporation, Research Memorandum RM-214, August 15, 1949 (Secret).
  37. Moore, L. L., *Aerodynamic Heating Relations*, Project RAND, The RAND Corporation, Research Memorandum RM-144, April 18, 1949.
  38. ———, "A Solution of the Laminar Boundary Layer Equations for a Compressible Fluid with Variable Properties Including Dissociation," Project RAND, The RAND Corporation, Paper P-50, January 12, 1949.
  39. Grimmingen, G., E. P. Williams, and G. B. W. Young, "Lift on Inclined Bodies of Revolution in Hypersonic Flow," *J. Aeronaut. Sci.*, Vol. 17, No. 11, November, 1950, pp. 675-690.
  40. Krueger, R. W., and G. Grimmingen, *Aerodynamics, Gas Dynamics, and Heat Transfer Problems of a Satellite Rocket*, Project RAND, The Douglas Aircraft Company, Inc., Report RA-15022, February 1, 1947 (Secret).
  41. *Hydrazine Study for Navy Department, Bureau of Aeronautics*, The Ralph M. Parsons Company, Vol. 1, April 6, 1950 (Confidential).
  42. *High Altitude Sounding Rocket—RTV-N-12 (Viking)*, Glenn L. Martin Company, Progress Report No. 15, April 15, 1949 (Confidential).
  43. Buchy, L. G., *Structural Test of 70-Inch Diameter Stainless Steel Integral Propellant Tank (Unstiffened)*, North American Aviation, Inc., Report AL-686, September 9, 1949 (Confidential).
  44. ———, *Structural Test of Two 70-Inch Diameter Stainless Steel Integral Propellant Tanks (Stiffened)*, North American Aviation, Inc., Report AL-1154, November 1, 1950 (Confidential).
  45. *Project MX-770*, North American Aviation, Inc., Progress Report No. 20, October 15, 1948 (Secret).
  46. *Project MX-770*, North American Aviation, Inc., Progress Report No. 28, July 15, 1950 (Secret).
  47. Rose, A., "Television Pickup Tubes and the Problem of Vision," in L. Marton (ed.), *Advances in Electronics*, Vol. 1, Academic Press, Inc., New York, 1948, pp. 131-166.
  48. Weimer, P. K., S. V. Fogue, and R. R. Goodrich, "The Vidicon Photoconductive Camera Tube," *Electronics*, Vol. 23, No. 25, May, 1950, pp. 70-73.
  49. Cawein, M., "Television Resolution as a Function of Line Structures," *Proc. I.R.E.*, Vol. 33, December, 1945, pp. 855-864.
  50. Hewson, E. W., "The Reflection, Absorption, and Transmission of Solar Radiation by Fog and Cloud," *Quart. J. Roy. Met. Soc.*, Vol. 69, 1943, p. 47.
  51. *International Critical Tables of Numerical Data, Physics, Chemistry, and Technology*, Vol. 5, McGraw-Hill Book Company, Inc., New York, 1929, p. 262.
  52. *Handbook of Chemistry and Physics*, 1943 ed., pp. 2147-2148.
  53. *Handbook of Meteorology*, F. A. Barry et al. (eds.), McGraw-Hill Book Company, Inc., New York, 1945, p. 932.
  54. *Ibid.*, p. 296.
  55. "Meteorological Factors in Wave Propagation," *Proc. Phys. Soc.*, London, 1948.

- 
56. Wehner, R. S., *Satellite to Surface Communication—Equatorial Orbit*. Project RAND. The RAND Corporation. Research Memorandum RM-603. July, 1949 (Published: April, 1951) (Secret).
  57. Chambré, P. L., and S. A. Schaaf, *The Theory of the Impact Tube at Low Pressures*. University of California, Eng. Research Projects Report HE-150-46, Mar. 1948. (Also, *J. Aeronaut. Sci.*, Vol. 15, No. 12, December, 1948, pp. 735-737.)
  58. Hurlbut, F. C., *An Experimental Investigation of Flow through Short Tubes for Large Molecular Mean Free Path*. University of California, Eng. Research Projects Report HE-150-54. March 7, 1949.