

THE U.S. ARMY'S MECHANIZED CAVALRY  
DOCTRINE IN WORLD WAR II

A thesis presented to the Faculty of the U.S. Army  
Command and General Staff College in partial  
fulfillment of the requirements for the  
degree

MASTER OF MILITARY ART AND SCIENCE

by

LOUIS A. DIMARCO, MAJOR, USA  
B.S., United States Military Academy,  
West Point, New York, 1981

Fort Leavenworth, Kansas  
1995

Approved for public release; distribution is unlimited.

19950927 131

# REPORT DOCUMENTATION PAGE

Form Approved  
OMB No. 0704-0188

Public reporting burden for this collection of information is estimated to average 1 hour per response, including the time for reviewing instructions, searching existing data sources, gathering and maintaining the data needed, and completing and reviewing the collection of information. Send comments regarding this burden estimate or any other aspect of this collection of information, including suggestions for reducing this burden, to Washington Headquarters Services, Directorate for Information Operations and Reports, 1215 Jefferson Davis Highway, Suite 1204, Arlington, VA 22202-4302, and to the Office of Management and Budget, Paperwork Reduction Project (0704-0188), Washington, DC 20503.

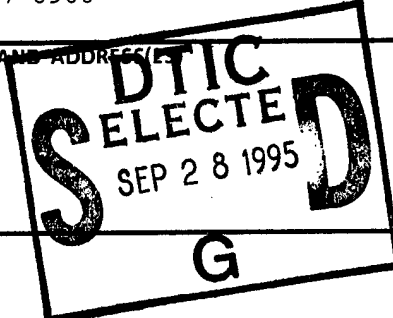
<b>1. AGENCY USE ONLY (Leave blank)</b>		<b>2. REPORT DATE</b> 2 June 1995	<b>3. REPORT TYPE AND DATES COVERED</b> Master's Thesis, 2 Aug 94 - 2 Jun 95	
<b>4. TITLE AND SUBTITLE</b>  The U.S. Army's Mechanized Cavalry Doctrine in World War II			<b>5. FUNDING NUMBERS</b>	
<b>6. AUTHOR(S)</b>  Major Louis A. DiMarco, U.S. Army				
<b>7. PERFORMING ORGANIZATION NAME(S) AND ADDRESS(ES)</b>  U.S. Army Command and General Staff College ATTN: ATZL-SWD-GD Fort Leavenworth, Kansas 66027-6900			<b>8. PERFORMING ORGANIZATION REPORT NUMBER</b>	
<b>9. SPONSORING / MONITORING AGENCY NAME(S) AND ADDRESS(ES)</b>			<b>10. SPONSORING / MONITORING AGENCY REPORT NUMBER</b>	
				
<b>11. SUPPLEMENTARY NOTES</b>				
<b>12a. DISTRIBUTION / AVAILABILITY STATEMENT</b>  Approved for public release, distribution is unlimited.			<b>12b. DISTRIBUTION CODE</b>  A	
<b>13. ABSTRACT (Maximum 200 words)</b>  This study focuses on doctrine of the U.S. Army's mechanized cavalry during World War II. The study identifies how and why doctrine proved inadequate for actual battlefield conditions. The North African Campaign demonstrated that the doctrine had only limited application to the World War II battlefield. Combat experience revealed that cavalry missions were not limited to reconnaissance, which constituted the main mission under mechanized cavalry doctrine, but included the complete range of traditional horse cavalry missions as well. Combat further revealed that cavalry had to fight to gain information. Although doctrine was adjusted during the war, the published tactical and operational concepts never caught up with the reality of the battlefield. The campaign in Northwest Europe confirmed many of the lessons learned in North Africa, and revealed the importance of the corps cavalry groups to corps level maneuver. The published mechanized cavalry doctrine of World War II did not meet the needs of the battlefield, yet the cavalry's combat record in World War II was impressive. This record of success, and the reasons for it, are still relevant to modern armored cavalry as well as to future Force XXI Army designs and concepts.				
<b>14. SUBJECT TERMS</b> U.S. Army, Cavalry, Mechanized Cavalry, Doctrine, World War II, Organization, Reconnaissance			<b>15. NUMBER OF PAGES</b> 165	
			<b>16. PRICE CODE</b>	
<b>17. SECURITY CLASSIFICATION OF REPORT</b> Unclassified	<b>18. SECURITY CLASSIFICATION OF THIS PAGE</b> Unclassified	<b>19. SECURITY CLASSIFICATION OF ABSTRACT</b> Unclassified	<b>20. LIMITATION OF ABSTRACT</b> Unlimited	

**DTIC QUALITY INSPECTED 6**

## GENERAL INSTRUCTIONS FOR COMPLETING SF 298

The Report Documentation Page (RDP) is used in announcing and cataloging reports. It is important that this information be consistent with the rest of the report, particularly the cover and title page. Instructions for filling in each block of the form follow. It is important to *stay within the lines* to meet *optical scanning requirements*.

**Block 1. Agency Use Only (Leave blank).**

**Block 2. Report Date.** Full publication date including day, month, and year, if available (e.g. 1 Jan 88). Must cite at least the year.

**Block 3. Type of Report and Dates Covered.** State whether report is interim, final, etc. If applicable, enter inclusive report dates (e.g. 10 Jun 87 - 30 Jun 88).

**Block 4. Title and Subtitle.** A title is taken from the part of the report that provides the most meaningful and complete information. When a report is prepared in more than one volume, repeat the primary title, add volume number, and include subtitle for the specific volume. On classified documents enter the title classification in parentheses.

**Block 5. Funding Numbers.** To include contract and grant numbers; may include program element number(s), project number(s), task number(s), and work unit number(s). Use the following labels:

<b>C</b> - Contract	<b>PR</b> - Project
<b>G</b> - Grant	<b>TA</b> - Task
<b>PE</b> - Program Element	<b>WU</b> - Work Unit Accession No.

**Block 6. Author(s).** Name(s) of person(s) responsible for writing the report, performing the research, or credited with the content of the report. If editor or compiler, this should follow the name(s).

**Block 7. Performing Organization Name(s) and Address(es).** Self-explanatory.

**Block 8. Performing Organization Report Number.** Enter the unique alphanumeric report number(s) assigned by the organization performing the report.

**Block 9. Sponsoring/Monitoring Agency Name(s) and Address(es).** Self-explanatory.

**Block 10. Sponsoring/Monitoring Agency Report Number.** (If known)

**Block 11. Supplementary Notes.** Enter information not included elsewhere such as: Prepared in cooperation with...; Trans. of...; To be published in.... When a report is revised, include a statement whether the new report supersedes or supplements the older report.

**Block 12a. Distribution/Availability Statement.** Denotes public availability or limitations. Cite any availability to the public. Enter additional limitations or special markings in all capitals (e.g. NOFORN, REL, ITAR).

**DOD** - See DoDD 5230.24, "Distribution Statements on Technical Documents."

**DOE** - See authorities.

**NASA** - See Handbook NHB 2200.2.

**NTIS** - Leave blank.

**Block 12b. Distribution Code.**

**DOD** - Leave blank.

**DOE** - Enter DOE distribution categories from the Standard Distribution for Unclassified Scientific and Technical Reports.

**NASA** - Leave blank.

**NTIS** - Leave blank.

**Block 13. Abstract.** Include a brief (*Maximum 200 words*) factual summary of the most significant information contained in the report.

**Block 14. Subject Terms.** Keywords or phrases identifying major subjects in the report.

**Block 15. Number of Pages.** Enter the total number of pages.

**Block 16. Price Code.** Enter appropriate price code (*NTIS only*).

**Blocks 17. - 19. Security Classifications.** Self-explanatory. Enter U.S. Security Classification in accordance with U.S. Security Regulations (i.e., UNCLASSIFIED). If form contains classified information, stamp classification on the top and bottom of the page.

**Block 20. Limitation of Abstract.** This block must be completed to assign a limitation to the abstract. Enter either UL (unlimited) or SAR (same as report). An entry in this block is necessary if the abstract is to be limited. If blank, the abstract is assumed to be unlimited.

THE U.S. ARMY'S MECHANIZED CAVALRY  
DOCTRINE IN WORLD WAR II

A thesis presented to the Faculty of the U.S. Army  
Command and General Staff College in partial  
fulfillment of the requirements for the  
degree

MASTER OF MILITARY ART AND SCIENCE

by

LOUIS A. DiMARCO, MAJOR, USA  
B.S., United States Military Academy,  
West Point, New York, 1981

Accession For	
NTIS CRA&I	<input checked="" type="checkbox"/>
DTIC TAB	<input type="checkbox"/>
Unannounced	<input type="checkbox"/>
Justification .....	
By .....	
Distribution /	
Availability Codes	
Dist	Avail and/or Special
A-1	

Fort Leavenworth, Kansas  
1995

Approved for public release; distribution is unlimited.

MASTER OF MILITARY ART AND SCIENCE

THESIS APPROVAL PAGE

Name of Candidate: Major Louis A. DiMarco

Thesis Title: The U.S. Army's Mechanized Cavalry Doctrine in World War II

Approved by:

  
\_\_\_\_\_, Thesis Committee Chairman  
Christopher R. Gabel, Ph.D.

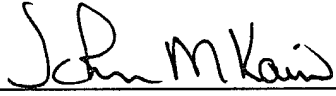
  
\_\_\_\_\_, Member  
Colonel John M. Kain, M.B.A.

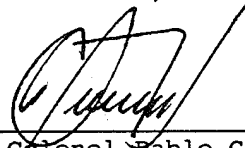
  
\_\_\_\_\_, Member  
Lieutenant Colonel Pablo Guevara, M.A.

  
\_\_\_\_\_, Member  
Lieutenant Colonel Dwain L. Crowson, M.A.

Accepted this 2d day of June 1995 by:

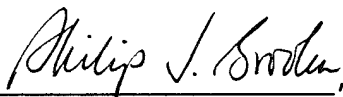
  
\_\_\_\_\_, Director, Graduate Degree Programs  
Philip J. Brookes, Ph. D.

The opinions and conclusions expressed herein are those of the student author and do not necessarily represent the view of the U.S. Army Command and General Staff College or any other governmental agency. (References to this study should include the foregoing statement.)

## ABSTRACT

THE U.S. ARMY'S MECHANIZED CAVALRY DOCTRINE IN WORLD WAR II By Major Louis A. DiMarco, USA, 158 pages.

This study focuses on doctrine of the U.S. Army's mechanized cavalry during World War II. The study identifies how and why doctrine proved inadequate for actual battlefield conditions

The North African Campaign demonstrated that the doctrine had only limited application to the World War II battlefield. Combat experience revealed that cavalry missions were not limited to reconnaissance, which constituted the main mission under mechanized cavalry doctrine, but included the complete range of traditional horse cavalry missions as well. Combat further revealed that cavalry had to fight to gain information.

Although doctrine was adjusted during the war, the published tactical and operational concepts never caught up with the reality of the battlefield. The campaign in Northwest Europe confirmed many of the lessons learned in North Africa, and revealed the importance of the corps cavalry groups to corps level maneuver.

The published mechanized cavalry doctrine of World War II did not meet the needs of the battlefield, yet the cavalry's combat record in World War II was impressive. This record of success, and the reasons for it, are still relevant to modern armored cavalry as well as to future Force XXI Army designs and concepts.

## ACKNOWLEDGMENTS

First I would like to acknowledge the support and the understanding of my family, without which this project would not have been possible. Next in importance are the members of the committee whose time and eye for detail were invaluable to the process of completing this project.

A special note of thanks to Colonels Thomas A. Dials, and Peter D. Wells, fellow cavalrymen whose expertise in the arena of cavalry doctrine, and interest in the subject, was critical to keeping me focused.

Finally, a note of appreciation to all the members of the Combined Arms Research Library (CARL) staff for their assistance locating the primary sources and doctrinal publications which are the heart of this work

TABLE OF CONTENTS

	<u>Page</u>
APPROVAL PAGE . . . . .	ii
ABSTRACT . . . . .	iii
ACKNOWLEDGMENTS . . . . .	iv
LIST OF FIGURES . . . . .	vi
CHAPTER	
1. INTRODUCTION . . . . .	1
2. PREWAR DEVELOPMENT OF CAVALRY AND RECONNAISSANCE . . . . .	7
3. COMBAT AND LESSONS LEARNED 1942-1944 . . . . .	35
4. COMBAT AND POST WAR REVIEW 1944-1945 . . . . .	75
5. THE LEGACY OF MECHANIZED CAVALRY . . . . .	130
BIBLIOGRAPHY . . . . .	149
INITIAL DISTRIBUTION LIST . . . . .	157



LIST OF ILLUSTRATIONS

<u>Figure</u>	<u>Page</u>
1. Cavalry Regiment (Mechanized), 1938 . . . . .	9
2. Armored Car Troop, 1933-1934 . . . . .	10
3. Reconnaissance Troop, 1938 . . . . .	13
4. Cavalry Regiment (Horse and Mechanized), 1941 . . . . .	18
5. 107th Cavalry (horse and Mechanized), Louisiana, 1940 . . . . .	19
6. Reconnaissance Platoon, 1941 . . . . .	22
7. Scout Cars of the 13th Cavalry Regiment (Mechanized), 1939 . . . . .	23
8. Cavalry Reconnaissance Squadron (CRS), 1942 . . . . .	25
9. M3 White Armored Car . . . . .	28
10. 1/4 Ton Bantam--"Jeep" . . . . .	28
11. M3 Stuart Light Tank . . . . .	29
12. Cavalry Reconnaissance Platoon, 1942 . . . . .	36
13. Reconnaissance Platoon (Armored Reconnaissance Battalion), 1942 . . . . .	37
14. M3, Light Tank, 1st Armored Division, Tunisia, 1943 . . . . .	38
15. Reconnaissance to Station de Sened . . . . .	39
16. Dispositions of 81st ARB, 14-15 February, 1943 . . . . .	43
17. Reconnaissance Patrol in North Africa. . . . .	47
18. Attack on Djebel Ichkeul . . . . .	50
19. T30, 75-mm Assault Gun . . . . .	53
20. Cavalry Reconnaissance Squadron, 1943. . . . .	64
21. Cavalry Reconnaissance Platoon, 1943 . . . . .	65
22. M8, Armored Car, "Greyhound" . . . . .	66
23. M8, 75-mm Assault Gun . . . . .	67
24. M5A1, Light Tank . . . . .	67

25. VIII Corps Dispositions, December 1944.. . . . .	82
26. 14th Cavalry Group Positions, 16 December 1944 . . . . .	84
27. 3d Cavalry Group Disposition, October, 1944. . . . .	90
28. M8 Assault Gun in Action . . . . .	93
29. 2d Cavalry Group Delay at Luneville. . . . .	94
30. 25th CRS Leading Attack to Bastogne. . . . .	98
31. Cavalry Advancing During the Summer of 1944. . . . .	100
32. 82d ARB Leads Allies into Belgium. . . . .	101
33. M8 Armored Car in Winter Camouflage. . . . .	104
34. M5A1 of the 4th Cavalry Group. . . . .	106
35. 24th CRS Reconnaissance of the Cotentin Peninsula . . . . .	107
36. M24 Light Tank, "General Chaffee". . . . .	120
37. M24 Light Tank in Action, 117th CRS, 1945. . . . .	121
38. The General Board Recommended Cavalry Regiment . . . . .	131
39. Reconnaissance Platoon, 1950 . . . . .	132
40. Armored Cavalry Regiment (Light) and Reconnaissance Battalion, 1948 . . . . .	134
41. H-Series Cavalry Platoon, 1981 . . . . .	136
42. Current Armored Cavalry Regiment . . . . .	136

## CHAPTER ONE

### INTRODUCTION

World War II saw the retirement of the horse cavalry of the US Army, and its replacement by mechanized cavalry. The mechanization of cavalry began in the early 1930s and was essentially completed during the course of World War II. Mechanization caused a change in doctrine. Unlike horse cavalry, which was an all purpose, mobile combat force, the Army's mechanized cavalry evolved into a specialized force whose doctrinal role was reconnaissance. Unfortunately, the mechanized cavalry's doctrine of reconnaissance did not match the needs of the World War II battlefield.

Combat revealed several short-comings in mechanized cavalry doctrine. At the tactical level doctrine focused exclusively on the reconnaissance mission, and did not recognize the importance of combat power to effective reconnaissance. Combat also demonstrated that in the absence of horse cavalry, mechanized cavalry could not specialize in reconnaissance. Combat revealed that mechanized cavalry must execute the traditional missions of horse cavalry. At the operational level, doctrine did not articulate the role cavalry played as an element of economy of force.

The years just prior to World War II were full of great turmoil, experimentation, improvisation, and expansion in the US Army. The range of issues facing the cavalry arm are illustrative of the type of issues

faced by all of the Army's services. Cavalry was attempting to implement mechanization, determine the continued feasibility of the horse, expand ten fold, develop doctrine, and plan new organizational structures. An indication of the rapid transitions going on in the branch is the fact that in 1940 three different types of cavalry regiments existed in the Army: horse regiments; mechanized regiments; and combination horse and mechanized regiments.

Each of the three types of cavalry had a unique niche in the force structure. Horse cavalry regiments were the main-stay of the cavalry force, existing both as separate organizations and as part of cavalry divisions. The combined horse and mechanized regiments were a unique type of separate cavalry regiment designed to provide long range truck mobility to horse units combined with some of the fire power and mobility characteristics of mechanized elements. Finally, the purely mechanized regiments were the forerunners of the armored regiments and battalions that would fight World War II. Each of these unit types had unique doctrine and supporting organization and equipment.

In June of 1940, the mechanized cavalry regiments of the 7th Cavalry Brigade at Fort Knox demonstrated themselves to be so different from the other cavalry organizations that the Army Chief of Staff, General George C. Marshall, ordered that they and their infantry counter-part, form the nucleus of a new arm of service: the Armored Force.

The Armored Force came into existence because of a basic belief held by both tank and cavalry advocates; that armor was fundamentally different from cavalry. This difference transcended the obvious

difference in equipment and was fundamentally associated with roles and missions. The exact role of cavalry in an age of mechanized war was to vex the branch and the Army through the early years of World War II. One result of the Army's ambiguity regarding the roles and missions of cavalry on the emerging battlefield was no significant commitment of mechanized cavalry units to combat until June, 1944, fully two and half years after the war began.

The most decisive action taken to correct what had become, by early 1942, a confusing mass of different types of cavalry organizations, was the Army reorganization orders of 1942 and 1943. The reorganization of 1942 established the mechanized cavalry squadron and group organizations as the corps separate cavalry. The Army reorganization of 1943 standardized the cavalry reconnaissance squadron (CRS) (mechanized) for all corps and divisional cavalry. The cavalry reconnaissance (mechanized) designation defined mechanized cavalry's role as an arm within the Army. Henceforth, mechanized cavalry and the reconnaissance mission were synonymous.

Although officially designated as cavalry reconnaissance in 1943, mechanized cavalry had long emphasized reconnaissance over other missions in training, organization, and equipment. From the beginning of mechanization to the reorganization of the mechanized squadron in 1943, doctrine emphasized stealth as the primary technique for obtaining reconnaissance information. Reconnaissance units were equipped primarily with armored cars because of their range, speed, armor, and effectiveness as reconnaissance platforms. Tanks were rejected because of their size, noise, and limited operating radius. Doctrine considered

the likelihood of the cavalry reconnaissance organization fighting to be low, therefore, authorized only a few light tanks in the squadron organization. Fighting, a traditional cavalry task, was to be the domain of horse cavalry.

The limited applicability of the tactical technique of stealth for reconnaissance became evident in the early campaigns of the World War II, primarily in North Africa. Lessons learned caused the Army Ground Forces (AGF) to reorganize the mechanized cavalry in 1943 to give the squadron and troop the ability of fight for information. However, the limited scope of early Army actions in North Africa and Sicily precluded the recognition of all of the short-falls of mechanized cavalry doctrine.

The latter campaigns of World War II demonstrated more basic doctrinal faults. Combat in Northwest Europe required cavalry reconnaissance units to do much more than reconnaissance. Cavalry performed the traditional roles of horse cavalry: defend and delay, exploit, attack, as well as reconnaissance. They revalidated the early findings that reconnaissance required fighting. Finally, the operation of multiple corps and field armies highlighted the unusual effectiveness of mechanized cavalry, and the critical requirement for corps cavalry to perform economy of force operations as a part of operational maneuver. Thus, the closing battles of World War II saw the cavalry reconnaissance units fighting the traditional missions of cavalry, but hampered by a doctrine, organization, and equipment designed primarily for reconnaissance.

The history of the cavalry arm as it transitioned to mechanization is key to understanding how and why US Army mechanized cavalry doctrine proved inadequate to the battlefield of World War II. Cavalry's key role in development of the Armored Force distracted it from paying serious attention to the development of mechanized cavalry doctrine. A wide variety of factors, most important among them combat experience, forced the Army to reevaluate the role of cavalry on the battlefield. Unfortunately, updating doctrine in the field did not alleviate the problems of organization and equipment.

The legacy of this experience is the US Army's modern armored cavalry. Modern armored cavalry is specifically designed as a robust organization capable of independent combat. The lesson of World War II is that at the tactical level of war armored cavalry must perform all the traditional cavalry missions, including security and reconnaissance. An associated lesson is that combat power is critical to successful accomplishment of all traditional cavalry missions, including reconnaissance. In addition, armored cavalry often attacks or defends in an economy of force role at the operational level of war. The 50 years of American military experience since World War II have demonstrate the validity of these lessons.

The lessons of World War II are of absolute importance as the US Army of the 1990s pursues an ambitious restructuring program. They are relevant when evaluating the organization and roles of the current armored cavalry force. They also provide some unique insights into the structure of the Army's force for the future, Force XXI. Today's Army modernization and reorganization efforts should heed the lessons learned

and demonstrated by the mechanized cavalry of World War II, and not repeat the mistakes of the past.



## CHAPTER TWO

### PREWAR DEVELOPMENT OF CAVALRY AND RECONNAISSANCE

The heritage of American armored reconnaissance forces is firmly rooted in the horse cavalry. In 1930, the Army Chief of Staff General Charles P. Summerall, created the Army's first peacetime mechanized force with the terse order "Assemble that mechanized force now."<sup>1</sup> One component of that force, designed to perform the force's reconnaissance mission, was an armored car troop. This troop, Troop A, 2d Armored Car Squadron,<sup>2</sup> was the precursor of all armored reconnaissance units to follow. Its legacy to the mechanized cavalry of World War II was the doctrine of reconnaissance and the organization and equipment to support that doctrine.

The Mechanized Force (Experimental) did not receive unequivocal support from the Army which, like the rest of the country, was just beginning to feel the bite of the great depression. It was underfunded, underequipped, undermanned, and suffered from a general lack of priority. This changed with the arrival of a new chief of staff, General Douglas MacArthur, in 1931. MacArthur recognized the importance of mechanization but brought to it a viewpoint completely different from his predecessor. MacArthur believed that mechanization, rather than being a centralized War Department effort, should be pursued by the various branches and applied to their own distinct missions independently.<sup>3</sup> Toward this end the mechanized force was dissolved and

in its place each branch established its own mechanized structure, goals and priority.

Further guidance provided by the War Department declared that cavalry would have the lead for mechanization. This guidance, however, stopped short of making the cavalry branch the single centralized Army proponent. The War Department also directed that the cavalry completely mechanize one horse mounted regiment. In compliance, the 1st Cavalry regiment was dismounted and mechanized in 1933.<sup>4</sup> The equipment basis of the 1st Cavalry (Mechanized) was the remnants of the old mechanized force (experimental), specifically the armored car troop which "was the only useable element."<sup>5</sup>

The mechanized manual issued by the cavalry school in 1933 was the first Army effort to codify the doctrine of mechanized forces. This manual reflected the general view of the Army leadership of the time, and specifically the view of the cavalry school and the chief of cavalry: "Mechanization, as applied to cavalry, seeks to transplant the cavalry characteristics of mobility, firepower and shock to completely motor-propelled fighting units largely equipped with armored vehicles."<sup>6</sup> The major question to be addressed in 1933 was, through experimentation with the mechanized cavalry regiment, to what extent mechanization could and should replace the horse as the means of cavalry mobility.

To execute its missions the first cavalry regiment was organized generally as indicated in Figure 1. Although through the years 1933 to 1939 the organization went through numerous changes, its major components remained the same. The regiment's major fighting elements were two squadrons composed of combat cars. Combat car were defined as

"those types of armored vehicles having essentially fighting missions, including shock-action, and possessing firepower and comparatively heavier armor protection, and a high degree of cross-country mobility."<sup>7</sup> This meant light tanks. They were referred to as "combat cars" in order to circumvent congressional legislation which assigned "tanks" to the infantry branch. In addition to the combat car troops and squadrons, the regimental structure included a variety of combat, combat support, and combat service support units among which was the regimental armored car troop.

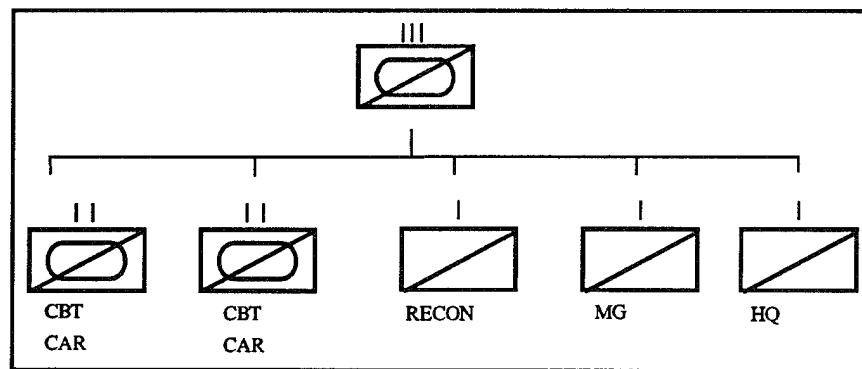

Figure 1. Cavalry Regiment (Mechanized), 1938.

Although the mechanized cavalry regiment was organized and employed to execute the traditional missions of cavalry, the armored car troop had only one primary mission--reconnaissance. Armored cars were defined as: "Those motor vehicles essentially of high road mobility and long radius of action, having fire power and protective armor, and whose mission is essentially reconnaissance."<sup>8</sup> Toward this purpose the troop was organized in 1933 with three platoons of five armored cars each (see

figure 2-2). The platoon was the basic tactical organization of the unit, with the capability of further breaking down into two autonomous sections of two and three armored cars each. The mission of the platoon was to conduct reconnaissance for the regiment. The armored car platoon was manned with 25 men armed with rifles and submachine guns.<sup>9</sup> Although referred to as an "armored car", the vehicle was armored only against small caliber weapons, and initially was not armed.

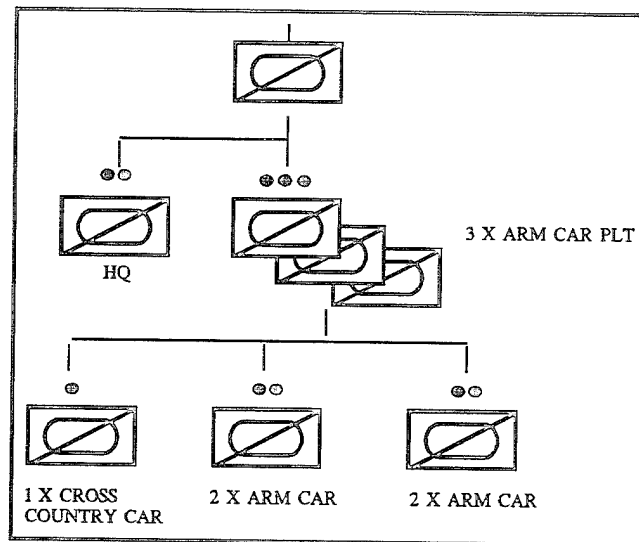

Figure 2. Armored Car Troop, 1933-1934.

The 1933 mechanized manual discussed techniques for successful reconnaissance by the armored car troop and its platoons. The armored car unit was not envisioned as a fighting organization.<sup>10</sup> Its stated purpose was "to obtain combat information to facilitate the successful employment of the regiment."<sup>11</sup> The troop was rarely employed together as a unit. Rather, the tactical element was the platoon, and when required, the two vehicle section.<sup>12</sup> In order to reconnoiter rough

terrain and maintain stealth the manual advocated dismounting.<sup>13</sup> The armored cars were to use their speed to avoid decisive engagement.<sup>14</sup> The manual advocated the armored car for reconnaissance because of its speed and radius of action, but pointed out its vulnerability to terrain and enemy fire.<sup>15</sup>

During the 1930s the 1st Cavalry Regiment (Mechanized) was one of the premier units of the US Army. This image was fostered by its various commanders, but most vigorously by its second commander Colonel Adna Chaffee. Largely through Chaffee's efforts, mechanization was slowly but consistently expanded, in spite of the lack of funding, and command support that was often unenthusiastic. In 1936 a second mechanized regiment, the 13th Cavalry, was added. The two regiments then were combined into the 7th Cavalry Brigade (mechanized), stationed at Fort Knox, Kentucky. The brigade was subjected to rigorous training and exercises in which the combat car squadrons were typically employed as the brigade's striking forces, guided by the regimental armored car troop on reconnaissance.

The concepts for employing the reconnaissance troop in conjunction with the combined arms of the rest of the brigade were most vividly demonstrated during maneuvers in June 1936 in Kentucky and Michigan. The 7th Cavalry brigade, task organized with a single mechanized cavalry regiment, an attached motorized artillery battery, and motorized infantry regiment, was pitted against two divisions of non-mechanized troops, including horse cavalry.<sup>16</sup> The employment of the armored car troop of the mechanized cavalry regiment to conduct reconnaissance for the brigade contributed significantly to the

brigade's success. The 7th Cavalry Brigade consistently avoided decisive engagement, harassed the enemy with long-range accurate artillery fires, and attacked the flanks and rear of his columns with the combat car squadrons. Brigadier General Bruce Palmer, the brigade commander, noted "how this troop moved rapidly around the flanks and rear of the Blue forces and between Blue columns. Seldom being observed or attacked yet always locating the important hostile units and promptly reporting them."<sup>17</sup> These maneuvers and others made the important point that decisive mounted action required rapid and accurate reconnaissance that only could be provided by specialized armored reconnaissance elements mounted in armored cars. The successful maneuver of the armored car platoons also validated the doctrine that advocated stealth and avoiding contact. The slow but steady expansion of mechanization is largely due to the success of such operations.

By 1938 each horse cavalry regiment had an armored car troop, organized similar to the troop in the mechanized regiment. The primary focus of this unit was reconnaissance.<sup>18</sup> It was used to execute deep strategic reconnaissance, taking advantage of the armored car's increased range and speed. Compared with small, horse-mounted cavalry reconnaissance elements, the armored car unit had a lot of fire power. However, it was limited by the requirement that it be augmented by horse-mounted rifle troops which would compensate for the armored car's lack of stealth and cross-country mobility.

In 1938 the Cavalry School published field manual FM 2-10, Mechanized Cavalry, the second manual presenting the organization, training, and doctrine of the mechanized cavalry. This manual

reinforced the elements of the 1933 manual and captured the techniques and lessons learned by the 7th Cavalry Brigade at Fort Knox. The manual confirmed much of what had been projected five years earlier: in the conduct of reconnaissance, the philosophy of stealth, the importance of dismounting, and the fundamentals of section and platoon movement were all reaffirmed.<sup>19</sup> The mechanized cavalry regiment was viewed simply as a fully mechanized version of the horse cavalry regiment,<sup>20</sup> and its roles and missions remained traditional. The combat car squadrons were still the heart of the regiment, with reconnaissance support provided by the armored car troop.<sup>21</sup>

The armored car troop expanded to four platoons of four armored cars (see figure 3), but the platoon was still the maneuver element.<sup>22</sup> The organization of the troop had also changed with the addition of five motorcycles in the troop headquarters.

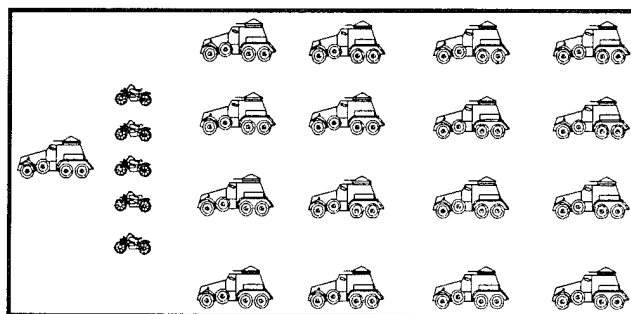

Figure 3. Reconnaissance Troop, 1938.

The general theme of the 1938 manual was to confirm the view of the out-going cavalry chief Major General Leon B. Kromer and other senior mechanized cavalrymen, such as Major General Daniel Van Vooris,

that mechanized cavalry was an integral part of the cavalry arm.<sup>23</sup> It also validated the concept of the mechanized cavalry regiment. The regiments and brigade were no longer viewed as an experiment in mechanization, but rather as equal partners with the horse cavalry elements of the branch. The final key point of the manual was the discussion of the supporting reconnaissance role of the armored car troops and squadron in the horse units. Armored cars were assigned to horse units because they were now considered to be very effective at reconnaissance. With improvements in technology came improvements in cross country mobility. This permitted the armored car units to conduct much more effective, stealthy reconnaissance. They had proven themselves to be, and were accepted as, superior in this role to the horse. Importantly, this was the only role they were assigned in either the horse or mechanized regiments.

The 1938 manual reflected cavalry's vision of mechanization. It was a traditional view of mechanized cavalry which saw the combat cars (light tanks) performing the traditional cavalry missions of pursuit, shock action, and exploitation, and the armored car elements conducting the traditional reconnaissance missions. This vision was not, however, shared by all cavalrymen. A significant faction of cavalrymen was beginning to become very inflexible and vocal in its opposition to mechanization in general, and any attempt to replace the horse with combat or armored cars in particular. This group was counterbalanced by another group, consisting mostly of mechanized cavalrymen, who envisioned an ever greater role for mechanized forces.

In 1938 a new Chief of Cavalry Major General John Herr was



appointed. Although not initially actively opposed to mechanization, he was not a vigorous proponent. His stated view was that mechanization should not come at the expense of a single mounted regiment.<sup>24</sup> On the opposite side of the issue were the leaders of mechanized cavalry, principally Brigadier Generals Palmer and Chaffee and Colonel Charles Scott (former and present commanders of the 7th Cavalry Brigade, and commander of the newly mechanized 13th Cavalry Regiment respectively).<sup>25</sup> They saw the combat cars of the cavalry for what they were--tanks. As early as 1939 Chaffee was speaking of organizing mechanized cavalry into division size armor units. In a speech to the US Army War College in September 1939, Chaffee stated that "mechanized cavalry [is] the newest fighting service."<sup>26</sup> The vision of these cavalymen and the position of MG Herr were on a collision course. The Army maneuvers which would begin in 1939 would test the tactical soundness of both positions. Horse and mechanized units would be matched head to head and the leadership of the Army would side with one faction or the other based on the outcome.

The most influential events, in terms of Army organizations and doctrine, occurring in the years 1938 to 1941, were the large unit Army maneuvers, collectively known as the "Louisiana Maneuvers." In this series of maneuvers, which occurred at the division, corps, and field army level, the mechanized cavalry brigade and its regiments performed superbly. They demonstrated that mechanized cavalry was a decisive force on the battlefield, and to an extent, the maneuvers became an exercise in developing organizations, equipment, and doctrine to stop the mechanized cavalry and other mechanized forces. The exercises,

combined with the continued championing of the influential 7th Cavalry Brigade Commander Adna Chaffee and the successes of German offenses in Poland and France convinced the Army leadership that an armored force was required--and quickly. Thus, in July 1940, at the conclusion of the corps-versus-corps maneuvers in Louisiana, the Armored Force was officially created. This began a chain of events and decisions which would greatly effect the development of cavalry and reconnaissance units through the end of World War II.

The maneuvers and world events demonstrated that armor, as mechanized cavalry was increasingly called, would be required to operate in division and corps size formations on the battlefield. The responsibility for organizing these large formations, since they would evolve primarily from the mechanized cavalry, was offered to General Herr, the Chief of Cavalry. General Chaffee supported that position. However, Herr was convinced that horses were still the key to cavalry's future and decided that cavalry and armor were not synonymous and therefore declined the mission.<sup>27</sup> This fateful decision would fundamentally affect the organization of the US Army through World War II.

General Marshall, based partly on Herr's position, created the Armored Force as an autonomous force with status equal to the existing combat arms branches. Brigadier General Chaffee was named its first commander. Simultaneously the 1st and 2d Armored divisions were authorized to be formed from the cavalry's 7th Cavalry Brigade (mechanized) and the infantry's provisional tank brigade respectively. These two units were then organized as an armored corps which General

Chaffee also commanded.

Within weeks of General Marshall's decision, the cavalry lost most of its mechanized elements and many of its brightest leaders. Marshall's decision sent ripples throughout the cavalry as bright officers either serving in horse units, or coming from West Point, swarmed to the Armored Force and ignored cavalry. Armor had captured not only the eye of the chief of staff and the Army, but also that of the public. With the departure of the 7th Cavalry Brigade (mechanized), mechanized cavalry was left virtually in the same position it had been in 10 years previously: predominately horse mounted. The mechanized forces of the cavalry in the summer of 1940 consisted primarily of two horse-mechanized regiments, one armored car squadron (in the 1st Cavalry division) and the armored car troops organic to each of the eight remaining active horse regiments. In addition, the decision had already been reached by General Headquarters to create an armored car troop to be organic to each of the new triangular infantry division which were being formed during this period.<sup>28</sup> None of these units contained any light tanks save one company organic to the armored car squadron of the cavalry division.<sup>29</sup>

With the departure of the mechanized regiments, the most modern cavalry units were the 4th and 6th Cavalry Regiments (horse-mechanized). These units were a unique combination of horse cavalry and mechanized cavalry. Each regiment consisted of one squadron (horse-portee), consisting of three rifle troops, and one squadron (mechanized), consisting of two armored car troops and a motorcycle troop (see figure 4).<sup>30</sup> This organization was largely a product of General Herr's attempt

to achieve the mobility of mechanized cavalry while retaining the horse. The unit was envisioned as the possible savior of the horse cavalry. However, in practice it was found to retain many of the disadvantages of the horse units, while losing some of the advantages due to its increased and complicated logistics requirements. Rather than being the best of both organizations, it was the worst. Unfortunately, it was the only alternative that met MG Herr's requirement of retaining the horse. It had a mixed record of success during the Army maneuvers.

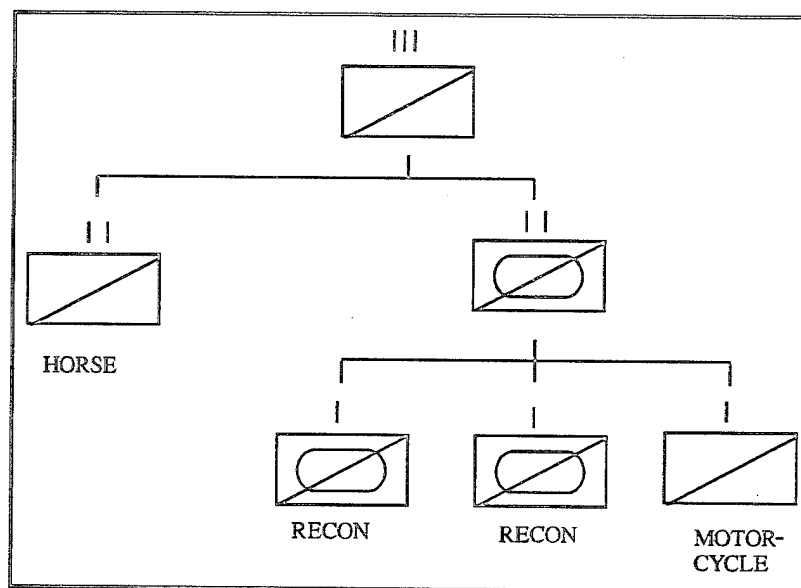

Figure 4. Cavalry Regiment (Horse and Mechanized), 1941.

The Louisiana Maneuvers, in addition to being the impetus for the creation of the armored force, offered many tactical insights into the performance of mechanized reconnaissance. It was found that armored cars were more versatile than previously thought. All mechanized units quickly came to understand that any mechanized or motorized movement had

to be preceded by rapid thorough reconnaissance that only armored car equipped units could provide. Armored car units were found to be very vulnerable to enemy infantry, antitank, and artillery attack. The solution to this threat was increased emphasis on stealth. Reconnaissance units were recognized as providing extremely effective artillery forward observers.



Figure 5. 107th Cavalry (Horse and Mechanized), Louisiana, 1940.  
Source: US Army photo reproduced from The Cavalry Journal (November-December, 1941) 77.

Organizations were also reviewed and tested. During the New York Maneuvers of 1939 a completely new type of mechanized cavalry regiment was first tested when the mechanized squadrons of two horse mechanized regiments were combined to form one totally mechanized

regiment consisting only of armored cars. This unit was very successful, but significantly, its role was limited to reconnaissance.

FM 2-15, Employment of Cavalry, was issued in April 1941. This manual was representative the cavalry's changed self-image. The most important characteristic of that image was the central position of the horse. FM 2-15 reflected the view of MG Herr of cavalry as a predominately horse organization supported by a limited number of mechanized elements. The manual addresses mechanized units throughout, but the theme is consistently horse cavalry supported by mechanized cavalry, usually in a reconnaissance role. The comments about mechanized cavalry during offensive operations are typical: "The mission of the scout car or motorcycle elements is primarily reconnaissance and security. They maneuver on the hostile flanks and rear to discover and give timely information of changes in hostile dispositions, primarily of movement of reserves."<sup>31</sup> FM 2-15 in 1941 reflected the dominance of the horse cavalry view, and, with the formation of the Armored Force, there were no longer any strong opposing voices.

In 1941 the Army also issued the last mechanized cavalry doctrine it would publish prior to the start of World War II, FM 2-10, Mechanized Cavalry, dated April 1941. This manual recognized the changes which had occurred since 1938, the lessons learned in the Army maneuvers, and established the standard cavalry doctrine employed at the start of World War II. The first, and most fundamental issue implicitly recognized by the manual, was the change in the role of mechanized cavalry relative to traditional cavalry missions. With the departure of

the majority of the tanks and the creation of the Armored Force, the missions of exploitation, pursuit, and shock action had been deferred to that organization and the horse elements of cavalry. Remaining for the mechanized cavalry was the reconnaissance mission, which was consistent with its organization and equipment, and clearly stated in the 1941 manual.<sup>32</sup> Horse cavalry retained its traditional missions, however, unrecognized by either FM 2-15 or FM 2-10 was that as of 1940 horse cavalry was not a significant player in the minds of the General Staff.

The 1941 manual also described the mechanized cavalry force as it existed in the spring of that year. The major organizations within the mechanized cavalry were the mechanized cavalry squadron organic to the horse-mechanized regiments, and the mechanized cavalry troops which were organic to the infantry divisions.<sup>33</sup> All mechanized troops had evolved from the 1938 organization, retaining four platoons of four scout cars each, and adding four motorcycle scouts to each platoon (see figure 6). This established two characteristics of reconnaissance and cavalry platoons that would remain relatively constant for the next four decades. First, the size of the platoon, at eight vehicles, was easily the largest combat platoon in that respect in the Army. The second characteristic was diversity. This platoon established the organizational precedent of mixing vehicle types to give the platoon the greatest diversity of capabilities. The squadron also included a motorcycle troop consisting of over 60 motorcycles organized into four platoons of fifteen each.

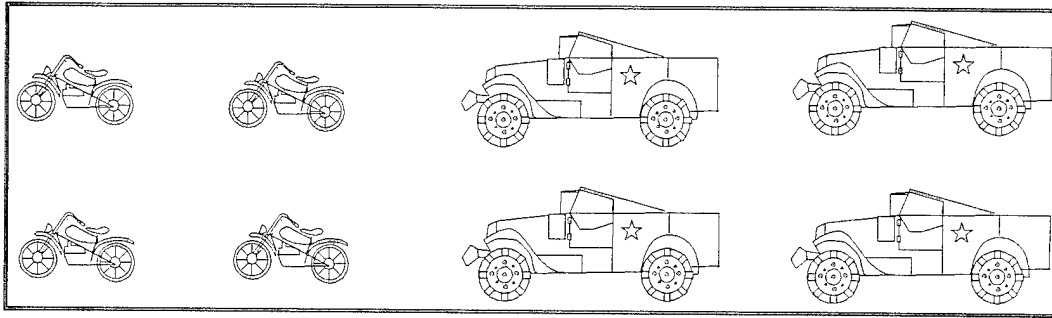

Figure 6. Reconnaissance Platoon, 1941.

Consistent with the change in the focus of mechanized cavalry, the manual put much greater emphasis on the reconnaissance mission and reconnaissance techniques than previous manuals. Where the 1938 manual devoted only 15 pages of text to reconnaissance techniques, the 1941 manual devoted 25 pages, plus a new chapter on scouting and patrolling techniques. A final subtle, but significant, indicator of the doctrinal shift towards reconnaissance, is the manual's consistent reference to cavalry soldiers and small units as "scouts," connoting reconnaissance as their principle purpose. The manual leaves little doubt that in the three years since the publication of the 1938 manual the mechanized cavalry had made significant doctrinal shift from an all-purpose mounted combat force, to a force that specialized in pure reconnaissance.

World War II began for the US in December 1941, eight months after the 1941 cavalry manual was published. In the months before and after Pearl Harbor the Army and the nation underwent full mobilization. The cavalry force was mobilized: all units being brought up to full strength; a second cavalry division authorized; national guard cavalry units reported for active duty; and new equipment was fielded. General



Headquarters (GHQ) made several decisions during this time period which would affect the development of the cavalry force. First, GHQ decided to deactivate the four national guard cavalry divisions and their organic regiments.<sup>34</sup> Second, the remaining seven national guard regiments were converted to horse-mechanized,<sup>35</sup> While it was decided to leave the two active cavalry divisions horse mounted for the time being.<sup>36</sup> This left the Army with nine separate cavalry regiments (horse-mechanized) and eight divisional regiments (horse).

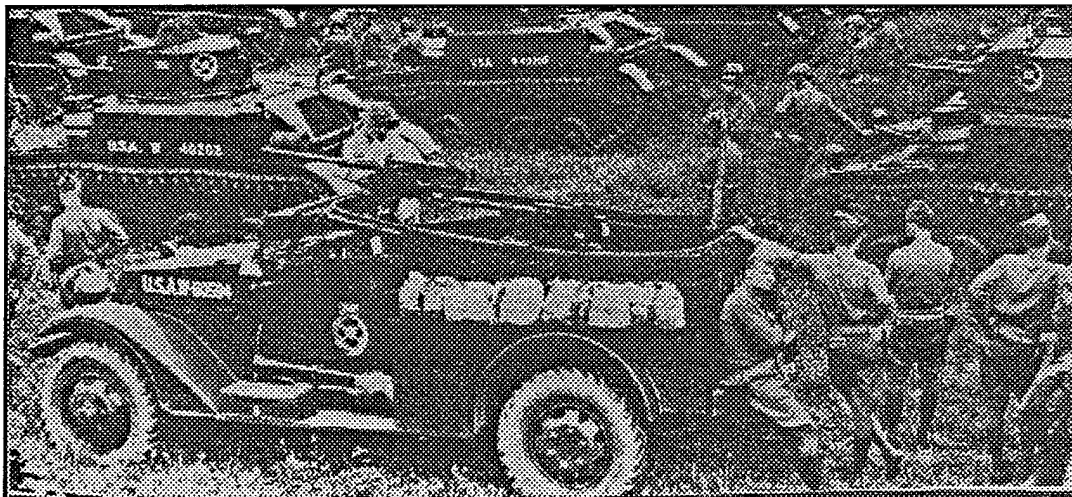

Figure 7. Scout Cars of the 13th Cavalry Regiment (Mechanized), 1939.  
Source: National Archives Photo reproduced in Steven Zaloga, Stuart, U.S. Light Tanks in Action (Carrollton, TX: Squadron/Signal Publications, Inc., 1979), 5.

At this point the views and actions, or more accurately inaction, of the Chief of Cavalry MG Herr, are again important. Mechanization proceeded slowly in all cavalry units. Officially, horses were still the decisive component of cavalry. Herr believed that "horses had stood the acid test of war whereas motorized elements had

not."<sup>37</sup> The separate horse-mechanized units were only partially mechanized, and their mechanized equipment arrived slowly. No thought was given to mechanizing the regiments of the cavalry divisions. The Chief of Cavalry defined cavalry as horses, and he was determined that that definition remained valid.

This situation continued until March 1942 when the office of the Chief of Cavalry, as well as that of the other combat arms chiefs, was abolished.<sup>38</sup> The powers of the branch chiefs was consolidated in the Commander, Army Ground Forces (AGF), Lieutenant General Lesley J. McNair. The consolidation eliminated the obstruction of the Chief of Cavalry's views regarding the horse. The immediate impact of this change in the command structure was the accelerated mechanization of the separate regiments.<sup>39</sup> It was General McNair's vision to field a fully mechanized Army in every respect.

AGF soon made a number of important changes which affected the cavalry force. The first among these was abolition of the regimental system for nondivisional troops in April of 1942.<sup>40</sup> This effectively eliminated the nine separate horse-mechanized regiments. All non-divisional regimental headquarters were replaced by "group" headquarters, and all nondivisional troops were organized into separate battalions or squadrons. The AGF did not create any separate horse cavalry squadrons. This effectively mechanized all nondivisional cavalry, creating a force of eighteen newly designated cavalry reconnaissance squadrons (mechanized), organized under the operational control of nine cavalry reconnaissance group (mechanized) headquarters.<sup>41</sup> These squadrons added a support troop (light tank) and

replaced the motorcycle troop with an additional reconnaissance troop (see figure 8). The organization was loosely organized on the model of the reconnaissance squadron organic to the cavalry division. The new unit title recognized the accepted doctrinal mission of reconnaissance.

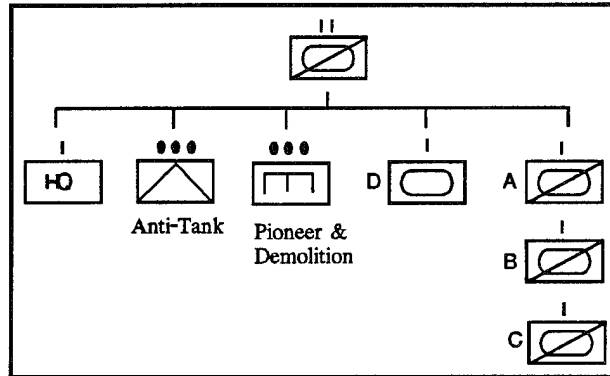

Figure 8. Cavalry Reconnaissance Squadron (CRS), 1942.

In 1942 divisional cavalry and reconnaissance forces, aside from the horse regiments of the cavalry divisions, consisted of a cavalry reconnaissance squadron organic to the cavalry division, and the troop organic to each triangular infantry division, as well as an armored reconnaissance battalion organic to each armored division. The infantry division reconnaissance troop was organized similarly to the reconnaissance troops of newly formed mechanized cavalry reconnaissance squadrons.<sup>42</sup> It consisted of four reconnaissance platoons each made up of four armored cars and four motorcycles.

The armored reconnaissance battalions of the newly formed armored divisions differed somewhat from the mechanized cavalry squadrons. They evolved directly from the experiences of the 7th

Cavalry Brigade regarding the importance of reconnaissance and the importance of combined arms. Thus the armored reconnaissance battalion was a more robust organization compared to the mechanized cavalry squadron. In 1940 the battalion's primary subunits were the two reconnaissance companies which were identical to the cavalry troops. Instead of a motorcycle troop, the armored reconnaissance battalion boasted a light tank company and an armored infantry company.<sup>43</sup> These two companies were designed to give the battalion a combined arms capability to fight through enemy reconnaissance elements and to conduct limited offensive and defensive operations. In 1942 the armored reconnaissance battalion was restructured making it similar to the cavalry reconnaissance squadron. The primary difference between the two being the presence of assault guns in the reconnaissance platoons. The battalion's doctrine was essentially that of the cavalry: conduct reconnaissance and avoid fighting. These reconnaissance units organic to the armored and infantry divisions, along with the nondivisional cavalry regiments, would be the cavalry and reconnaissance forces of the war.

The cavalry divisions remained horse mounted. This indicated that even General McNair did not seem to want to make the sensitive decision to unhorse cavalry forever. However, by the middle of 1942 it was understood that the US Army planned to fight a mechanized war. Eventually the 1st Cavalry division would see combat and fight well as infantry in the Pacific Theater.<sup>44</sup> The 2d Cavalry division was deployed overseas in early 1944 where it was deactivated, although some of its regimental designations were reactivated as cavalry reconnaissance

groups (mechanized) late in the war.<sup>45</sup>

During the years 1938 to 1942 the Army pursued a vigorous modernization program. This program also effected the cavalry and reconnaissance forces. The type of equipment chosen for mechanized cavalry was a direct reflection of its reconnaissance doctrine. Cavalry was not expected to fight; therefore there was no perceived need for medium armor. Stealth, speed, and cross country mobility were the characteristics considered most important for equipping cavalry. Fire power, though an important consideration, was secondary to mobility. Automatic weapons were considered sufficient at the platoon level, while light tanks were viewed as a squadron or battalion combat multiplier.

Initially, the primary vehicle of the reconnaissance forces was the M3 armored car.<sup>46</sup> It was a 4x4 wheeled vehicle with reasonable cross-country mobility. Its cross-country capability was a major improvement over the M1 and M2 armored cars that it replaced which were essentially commercial vehicles converted to military use. The M3 was also fairly heavily armed, mounting both .50 caliber and .30 caliber machine guns in addition to the personal weapons of the crew. It was also very fast: capable of sustained 45 miles per hour speeds on hard surface roads (see figure 9).<sup>47</sup>

In 1938 the cavalry also was equipped with a substantial number of motorcycles. These vehicles had good road mobility and were stealthy and enthusiastically received at first. Ultimately, however, they were found to be of only minimal use due to poor cross-country mobility, and safety and maintenance problems. In 1941 the Army began experimenting with "Bantams" (1/4-ton "jeeps"). These vehicles were considered far

superior to motorcycles and the Army planned to replace most of the motorcycles with this rugged and versatile new vehicle (see figure 10).<sup>48</sup>

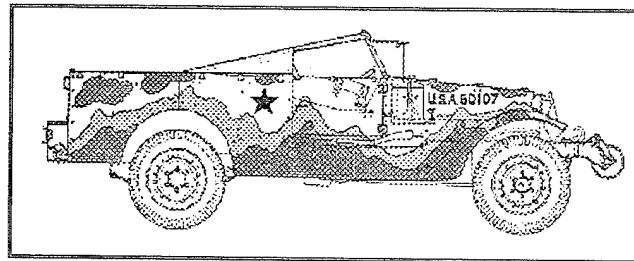

Figure 9. M3 White Armored Car. Source: Pearless Max, Plastic Model Kit Instruction Drawing, Kit No. 3507, undated.

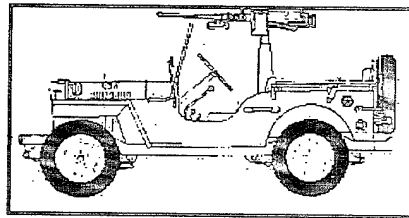

Figure 10. 1/4 Ton Bantam - "Jeep." Source: Italeri, Plastic Model Kit Instruction Drawing, Kit No. 326, undated.

Those units which were authorized light tanks began receiving the M3 Stuart in 1941. The Stuart was considered a very capable light tank design at the time of its debut. It mounted the standard 37-mm US Army antitank gun, which was regarded as considerable fire power for a light tank in 1941. Like the M3 armored car, the Stuart tank was mechanically reliable and fast. It was considered ideal for the type of missions that a reconnaissance force would be expected to conduct (see figure 11).

A variety of factors affected the equipping of mechanized cavalry. The equipment was tested extensively during the Army maneuvers of 1939 to 1941. The equipment held up well under the simulated battlefield conditions and seemed to meet the needs of the missions.

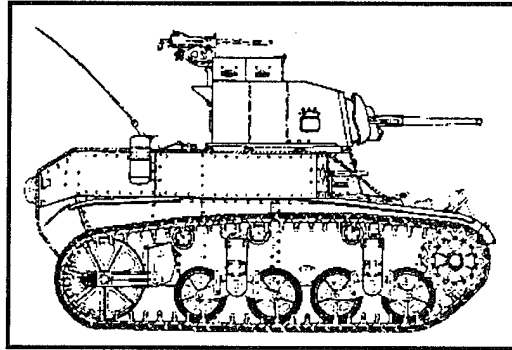

Figure 11. M3 Stuart Light Tank. Source: Military Modeler, Drawing from "Flame Thrower Stuart," Military Modeler (September, 1990): 11.

In addition the lessons perceived from the early campaigns in Europe and North Africa indicated that a fast armored car force was an important ingredient to success on a mechanized battlefield. The Germans and French employed over 900 armored cars in the 1940 campaign for France.<sup>49</sup> The British, who did not field a single armored car in the British Expeditionary Force in 1940, rapidly produced and fielded an extensive armored car reconnaissance force in the 1941-42 North African battles.<sup>50</sup> They reported the mobile conditions and terrain of North Africa were ideal for armored car equipped reconnaissance forces.<sup>51</sup> Therefore, it appeared in 1942, that the armored car equipped cavalry of the US Army was ideally suited for the war ongoing in Europe and Africa.

In November of 1942 US forces were committed for the first time

to combat in the war against Germany as part of Operation Torch. The American component of this operation was significant, and consisted of the best equipped, trained, and combat ready US Army forces available. The major combat elements were initially the 1st, 9th, and 3d Infantry Divisions, and the 1st and 2d Armored Divisions. These units all contained their organic cavalry reconnaissance troops or their armored reconnaissance battalions as appropriate. Significantly, no nondivision cavalry reconnaissance groups or squadrons were deployed for combat until near the end of this operation. This despite the fact that reports from both Germans and Allies had indicated that the mobile warfare practiced in North Africa was ideal for fast armored reconnaissance.

This was the legacy of MG Herr. The impact of his opposition to mechanization was not only the formation of the Armored Force, but was also the obsolescence of the cavalry force in 1942. It was not until the abolition of the Cavalry Chief's office in the spring of 1942, that structure, priority, and direction were applied to cavalry organizations. This was done from outside the force by the AGF. However, the restructuring and training required time and could only be accomplished on a limited scale prior to combat in North Africa. At the time of the Torch landings cavalry groups and squadrons were still receiving mechanized equipment, adjusting to new organizations and command relationships, and training toward their new reconnaissance role. Thus, cavalry and reconnaissance would be represented in North Africa primarily by the units organic to the deployed divisions. Still, these units were representative in terms of organization, equipment, and



doctrine, of the mechanized cavalry force as a whole. In terms of training, they were some of the best trained units in the Army at that time. Therefore, their performance in combat would be representative of the cavalry force, its organization, equipment, and doctrine.

### Endnotes

<sup>1</sup>Mildred Hanson Gillie, Forging the Thunderbolt (Harrisburg, PA: Military Service Publishing, 1947), 36.

<sup>2</sup>Ibid., 39.

<sup>3</sup>Ibid., 48.

<sup>4</sup>Mary Lee Stubbs and Stanely R. Conner, Army Lineage Series: Armor-Cavalry Part I: Regular Army and Army Reserve (Washington D.C.: Center of Military History US Army, 1984), 56.

<sup>5</sup>The Cavalry Journal, "Mechanized Cavalry," The Cavalry Journal (November- December, 1931): 53.

<sup>6</sup>US Army Cavalry School, Mechanized Cavalry, 1932-1933 (Fort Riley Kansas: The Cavalry School, 1932), 3.

<sup>7</sup>Ibid., 3.

<sup>8</sup>Ibid., 3.

<sup>9</sup>Ibid., 12.

<sup>10</sup>Ibid., 18.

<sup>11</sup>Ibid., 18.

<sup>12</sup>Ibid., 21.

<sup>13</sup>Ibid., 14.

<sup>14</sup>Ibid., 10.

<sup>15</sup>Ibid., 6.

<sup>16</sup>Bruce Palmer, "Mechanized Cavalry in the Second Army Maneuvers," The Cavalry Journal (November- December, 1936): 460.

<sup>17</sup>Ibid., 465.

<sup>18</sup>US Army Cavalry School, FM 2-10, Cavalry Field Manual: Vol. II, Mechanized Cavalry, (Fort Riley KS: US Army Cavalry School, 1938), 103.

<sup>19</sup>Ibid., 98.

<sup>20</sup>Ibid., 92.

<sup>21</sup>Ibid., 106.

<sup>22</sup>Ibid., not numbered, foldout page.

- 23 Donald E. Houston, Hell On Wheels (Novato, CA: Presido Press, 1977), 22.
- 24 Gillie, 112.
- 25 Houston, 8.
- 26 Ibid., 27.
- 27 Ibid., 16.
- 28 Kent Roberts Greenfield, The Organization of the Ground Combat Troops (Washington DC: Office of the Chief of Military History, Department of the Army, 1947), 309.
- 29 US Army Cavalry School, FM 2-10, Cavalry Field Manual: Mechanized Elements (Fort Riley, KS: US Army Cavalry School, 1941), 38.
- 30 C. P. Bixel, "Cavalry Motorcycle Troop," The Cavalry Journal (January- February, 1941): 52.
- 31 War Department, FM 2-15, Cavalry Field Manual, Employment of Cavalry (Washington D.C.: US Government Printing Office, 1941), 7-8.
- 32 US Army Cavalry School, FM 2-10, Cavalry Field Manual: Mechanized Elements (1941), 70.
- 33 Ibid., 70.
- 34 James A. Sawicki, Cavalry Regiments of the US Army (Virginia: Wyvern Publications, 1985), 114.
- 35 Ibid., 114.
- 36 Greenfield, 392.
- 37 Stubbs, 70.
- 38 Greenfield, 286.
- 39 Sawicki, 118.
- 40 Greenfield, 356.
- 41 Sawicki, 114.
- 42 US Army Cavalry School, FM 2-10, Cavalry Field Manual: Mechanized Elements (1941), 37.
- 43 I. D. White, "Reconnaissance Battalion, Armored Division," The Cavalry Journal (May-June, 1941): 48.

<sup>44</sup>Stubbs, 71.

<sup>45</sup>Ibid., 71.

<sup>46</sup>Gillie., 114.

<sup>47</sup>Ibid., 114.

<sup>48</sup>White, 86.

<sup>49</sup>R. M. Ogorkiewicz, Armoured Forces (New York: Arco Publishing Company, Inc., 1960), 433-434.

<sup>50</sup>Ibid., 433-434.

<sup>51</sup>Ibid., 437.

## CHAPTER THREE

### COMBAT AND LESSON LEARNED 1942-44

In November 1942, US forces participated in their first major campaign against the German Army in World War II, Operation Torch, the invasion of North Africa. The early battles in North Africa were the Army's first combat experience in mechanized warfare, and tested leaders, troops, equipment, organization, and doctrine. This was particularly true for the reconnaissance elements of the Army. Actions in North Africa demonstrated that the mechanized cavalry's tactical doctrine of reconnaissance did not address many of a commander's requirements on the battlefield.

North Africa saw all types of cavalry and reconnaissance forces engaged in a variety of combat missions, some of which were anticipated and some of which were not. These units included a corps separate cavalry reconnaissance squadron (CRS), an armored division armored reconnaissance battalion (ARB), and the separate cavalry reconnaissance troops (CRT) of infantry divisions. The only units which were not deployed to the theater were corps cavalry groups. The combination of the battle experiences of all these units provided a valid and comprehensive early battlefield test of the doctrine, organization, and equipment of the US Army's reconnaissance forces.

By the time of commitment to combat in late 1942 and early 1943, some changes had already occurred in the equipment and organization of

the reconnaissance units. The most significant change was the reorganization of the troops, companies and platoons. The total number of motorcycles within the troop was vastly reduced, since the function of the motorcycle was assumed by the 1/4-ton scout car or "jeep" (see figure 12).<sup>1</sup> The organization of the separate cavalry reconnaissance troop's platoon had not changed, except to introduce the jeeps as indicated in figure 10.

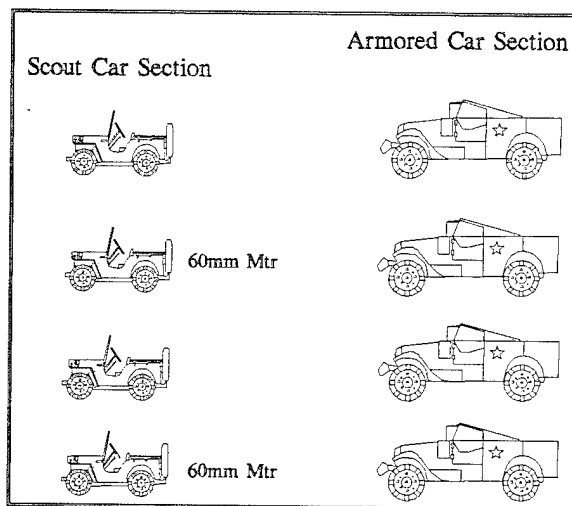

Figure 12. Cavalry Reconnaissance Platoon, 1942.

Another significant platoon level change was addition of indirect fire assets to the platoon. The reconnaissance platoon included two 60-mm mortars (in jeeps).<sup>2</sup> In addition, the reconnaissance platoon of the armored reconnaissance battalion included one 75-mm assault gun (self-propelled on a half-track vehicle)(see figure 13). These systems were intended to provide the reconnaissance platoon with its own organic fire support to facilitate independent operations.

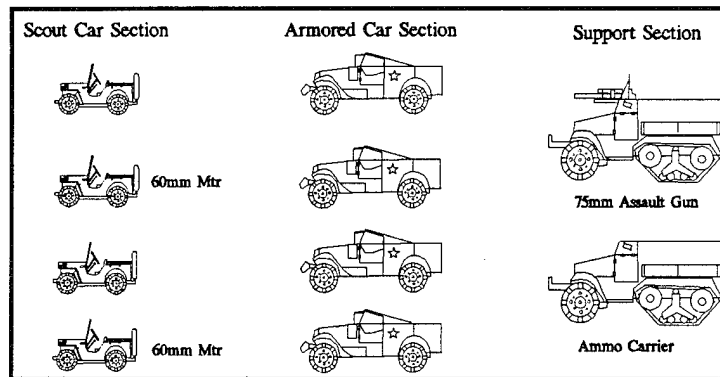

Figure 13. Reconnaissance Platoon (Armored Reconnaissance Battalion), 1942

### Combat

Doctrine for the employment of cavalry and armored reconnaissance units had not changed since the publication of the FM 2-10 in April of 1941. Thus doctrine emphasized reconnaissance conducted at the platoon level by the application of stealthy mounted and dismounted maneuver. It further advocated avoiding combat whenever possible, and when contact was made, by-passing it. Attack and defend, according to doctrine, were secondary missions, and were only conducted for limited purposes under special conditions. This doctrine was clearly understood when the 81st Armored Reconnaissance Battalion (ARB) was committed to combat for the first time on 31 January 1943. This first large scale test of the US reconnaissance forces challenged the soundness of reconnaissance doctrine.

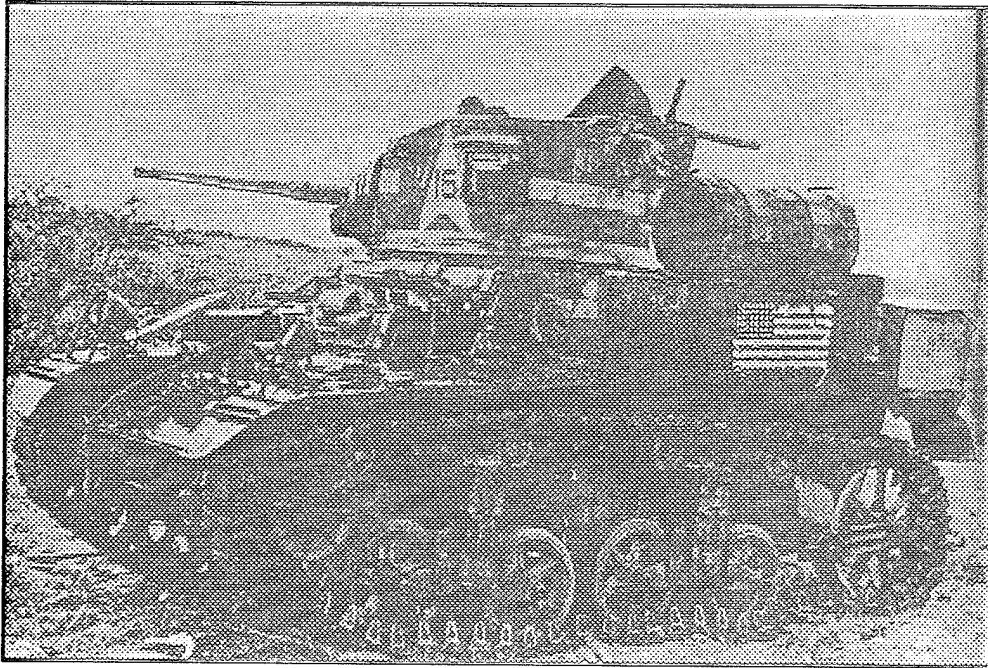

Figure 14. M3, Light Tank, 1st Armored Division, Tunisia, 1943.  
Source: Bundesarchiv Photo reproduced in Steven Zaloga, Stuart, U.S. Light Tanks in Action (Carrollton, TX: Squadron/Signal Publications, Inc., 1979), 16.

The 81st ARB, was under division control and organized with 3 reconnaissance companies and a tank company. It was given the mission of reconnaissance and seizing high ground to the north and south of the objective of Combat Command D (CCD), 1st Armored Division: Station de Sened (see figure 15).<sup>3</sup> The plan was to conduct the mission with two reconnaissance companies; one to the north and one to the south of the axis of advance.<sup>4</sup>

The reconnaissance elements executed their missions beginning at 0730, 31 January 1943.<sup>5</sup> Company C, moving on the northern shoulder of the axis was stopped by anti-tank fire, but was able to put dismounted observation posts on the high ground north of the objective.<sup>6</sup> Company A was stopped by a combination of machine gun fire and artillery. It was



unable to attain the high ground on the south side of the objective). At 1300 the attack was called off. Company A was in an untenable position, taking losses from artillery, and was forced to withdraw under the protective fire of the tank company and assault guns.<sup>7</sup> The following day the attack by CCD was resumed. The primary contribution of the 81st ARB was direction of artillery and assault gun fire from observation posts (OPs) established the previous day and during the night.

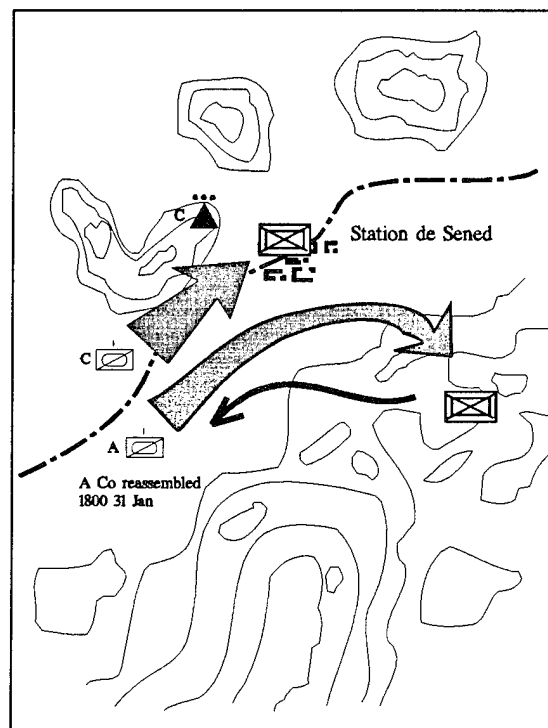

Figure 15. Reconnaissance to Station de Sened.

The execution of the US Army's first battalion level mechanized reconnaissance mission of the war had some obvious doctrinal

implications. First, the engagement demonstrated that the reconnaissance battalion was unable to infiltrate or by-pass a well positioned enemy. Doctrine specifically stated that this was the primary method of achieving reconnaissance objectives. Second, the vehicles of the reconnaissance troops (jeeps and M3 armored cars) were very vulnerable to machine guns, mortars, and artillery. Speed and stealth were not sufficient to protect the vehicles from the most common enemy weapon systems (machine guns and artillery). Finally, once in position, the reconnaissance troops did not have the combat power or armor protection to remain in position in the face of enemy direct and indirect fire. Doctrine assumed that the OP would be hidden from the enemy and therefore not subject to enemy fire. Clearly, the 81st ARB experience proved the error of this.

In addition to the reconnaissance doctrine shortfalls, it is also clear that the battalion did not help itself in terms of closely coordinating and effectively utilizing the resources it had available. The tank company could have been used in much closer support of the reconnaissance companies than it was. The potential effectiveness of utilizing the tanks and assault guns in closer coordination was demonstrated by the manner in which they effectively suppressed enemy fires during the withdrawal of Company A.

Security missions was defined as "all measures taken by a command to protect itself against annoyance, surprise, observation, and interference by the enemy."<sup>8</sup> FM 2-15, Employment of Cavalry, 1941, stated specifically that security for other arms was one of the prime missions of cavalry,<sup>9</sup> however, FM 2-10, 1941, did not discuss security

as a mission for mechanized cavalry at all. This lack of emphasis in FM 2-10, is in accordance FM 2-15 which discouraged the use of mechanized cavalry for this type of mission due to their "vulnerability to ambush and their unsuitability for sustained defense."<sup>10</sup> Only a single paragraph of the manual addresses security. FM 100-17, Field Regulations for Larger Units, dated April 1941, does not specifically mention cavalry in its chapter on security roles while it names cavalry, both mechanized and horse, as the primary means of ground reconnaissance.<sup>11</sup>

In contrast to the written doctrines lack of emphasis on security missions, the 81st ARB, during its initial month in combat, executed four battalion level security missions for the 1st Armored Division, while executing only one reconnaissance mission (described previously) during the same time period. This demonstrates a lack of appreciation of the relative importance of the reconnaissance and security missions in cavalry doctrine. In North Africa, the reconnaissance units were utilized much more for security purposes than doctrine foresaw.

On 14 February 1943 the 81st ARB was conducting a security mission as part of in the 1st Armored Division defense of Sidi-Bou-Zid. Specifically, the battalion was to observe key passes and routes entering the division area from the east and south. The division was defending as part of the II Corps, which was expecting a German attack. The allies, however, expected the German effort to fall north of II Corps, and that the II Corps and the 1st Armored Division would defend

against a supporting attack. The Germans, however, planned their main effort directly against the 1st Armored Division.

The battle began as a German attempt to cut off or destroy the majority of the US 1st Armored Division in its defensive positions north and west of Sidi-Bou-Zid.<sup>12</sup> The 81st ARB was deployed as follows (see figure 16): Company A in position along the high ground overlooking the Matleg Pass; Company B under division control, watching the division north flank; Company C in position on the high ground between Company A and Bir El Hafey (with one platoon in position to overwatch the Meloussi Pass; and battalion headquarters (HQ) and the tank company located in the vicinity of Sidi-Bou-Zid.<sup>13</sup>

As the battle began both reconnaissance companies (A and C) provided early and accurate warning on the enemy's action.<sup>14</sup> This action successfully completed their doctrinal mission of security. Then the missions quickly changed from security to defending and delaying. Company A was attached to the infantry battalion defending the Ksaria hill mass to the company's rear. Its mission was changed to defending the Ksaria pass, along with attached elements of Company C, 16th Engineers.<sup>15</sup> Company C, 81st ARB was told to delay the enemy between the Malossi Pass and Bir El Hafey.

Both reconnaissance companies fought hard against German mechanized units throughout the day of 14 February. The conclusion of the day's action found the remnants of Company A isolated in the Ksaria high ground area along with elements of the 16th Engineers and the 168th infantry regiment,<sup>16</sup> the bulk of the company with most of its vehicles had been cut off and captured in their positions east of Ksaria.<sup>17</sup> The

company was last heard from on 16 February<sup>18</sup> and the majority of the force was captured after attempting to break out on 17 February.<sup>19</sup> Company C, meanwhile, delayed back to Bir El Hafey on the 14th, losing one complete platoon in the process.<sup>20</sup> At that point it moved west and occupied the Rakrmar high ground, west of the German axis of advance (see figure 16).

On the 15th of February, the battalion received Company B back from division control. The battalion was then deployed with the headquarters west of Sbiala, Company B north of Sbiala, and Company C west of Bir EL Hafey. It was in these positions when ordered to withdraw to Kasserine.

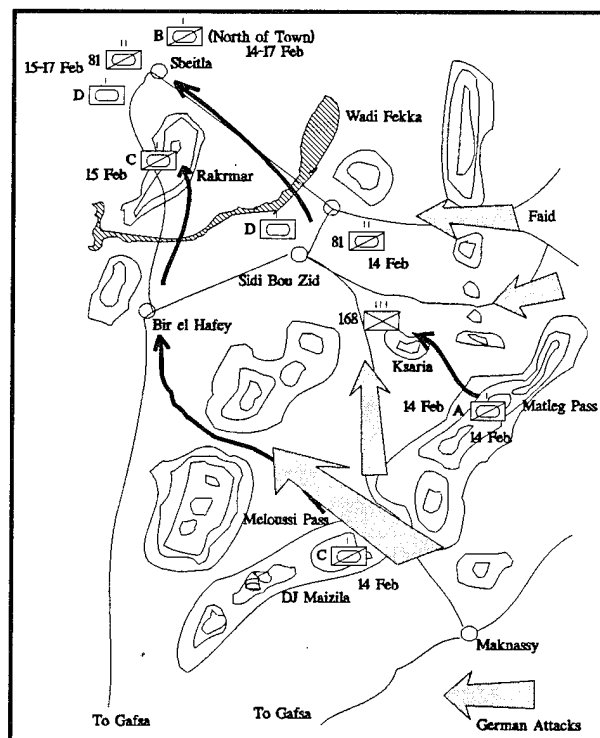

Figure 16. Dispositions of 81st ARB, 14-15 February, 1943.

Analysis of the mission indicates that the reconnaissance battalion was initially well positioned to conduct the security mission assigned. However there were problems with subsequent events. Positioning of the tank company was the most critical issue. The tank company was not committed from its positions with battalion headquarters to support the reconnaissance companies, leaving them to face German armor by themselves. Without tanks in close support the reconnaissance companies had virtually no tank killing capability, no mobile reserve, and were unable to establish any depth to their positions. In other words, they were incapable of effectively executing the assigned missions.

The most serious doctrinal mistake in the mission was the utilization of Company A. The unit was not designed to conduct a defense. Attaching it to a defending infantry regiment deprived it of the ability to maneuver. The company had the capability, along with their attached engineers, of driving out of the surrounded infantry position, or delaying back prior to encirclement, but its attachment to the infantry negated its mobility and made that impossible. The result was the complete loss of a valuable specialized unit with all of its equipment and experienced personnel.

It is important to note that the security and delay mission of the reconnaissance battalion was a key aspect of the armored division's scheme of maneuver. It permitted the division to take risk in order to concentrate combat power. This was a classic cavalry mission: cavalry performing an economy of force delay. This mission, however, was not one that received much doctrinal emphasis. It was barely referred to in

the 1941 mechanized cavalry manual. Finally, it was not one for which the battalion or companies were doctrinally trained, or structured. The results varied from marginal effectiveness to disaster in the case of Company A.

Reconnaissance doctrine clearly indicated that combat was only authorized under special circumstances such as "rapid seizure of distant objectives, delaying and harassing actions, establishment of temporary bridge heads, and counterreconnaissance."<sup>21</sup> Doctrine also advised reconnaissance leaders that security missions were primarily focused on providing the main body with early warning and information on the enemy, not protection. These tenets became eroded after the units were committed to combat. Reconnaissance leaders came to regard themselves as combat forces. They engaged in offensive combat whenever the situation was favorable, even when the mission was security.

An example of the offensive attitude, and the opportunistic leadership that typified the reconnaissance and cavalry leaders in the early North African campaign is the actions of a detachment of Company C, 81st ARB in early March 43.

The action took place after the battle of Kasserine pass. The enemy had moved the bulk of his forces to Faid or further east. Gafsa remained in enemy hands. The mission of the 81st ARB was to "watch" the roads leading into Gafsa from the west.<sup>22</sup> While establishing observation in the vicinity of Gafsa one of the Company C detachments observed a company size German force which "appeared to be taking things easy."<sup>23</sup> The platoon leader in charge requested authorization to conduct an attack to destroy the enemy. The detachment had previously

been reinforced with two additional assault guns and a platoon of tanks.<sup>24</sup> The detachment opened fire on the enemy and then "the tanks and scout cars charged the enemy position from a covered assembly point about 400 yards from the enemy. The Company C detachment killed several of the defenders, including the CO, captured 89 of them, seized 3 vehicles, and laid a small mine field in the pass. The assault guns and tanks were directed into positions from which they could cover this mine field." The Company C detachment successfully repelled an armored counter-attack the next day.<sup>25</sup>

The action of the detachment was clearly an attack. It was not "mission essential", unless the mission was much more than a security mission. The conclusion is that not only were the cavalry leaders much more aggressive than doctrine required or desired, but also that the commanders implied a much more aggressive posture than the word "watch" and security doctrine dictated. This example demonstrates the degree to which offensive combat, rather than being an action to be avoided, was engaged in at every favorable opportunity. This clearly is not the spirit expressed in the 1941 doctrinal rule: "[scout cars] avoid combat, except for self-protection or when accomplishment of the mission requires combat."<sup>26</sup> A significant aspect of the action is not that it was not within the letter or spirit of published reconnaissance doctrine, but that it was successful. That success questioned the fundamental soundness of the "sneak and peek" reconnaissance doctrine.

The actions of the cavalry and reconnaissance units in North Africa clearly demonstrated that attacking and defending were essential aspects of both reconnaissance and security missions. Combat had



demonstrated that when the reconnaissance units were aggressive, anticipated combat, and organized to conduct it, they were successful. Towards this end, the 81st ARB temporarily disbanded its tank company after the Kasserine actions, and permanently attached a tank platoon to each of its reconnaissance companies for the duration of the North African Campaign.<sup>27</sup> The creation of combined arms teams at company level had the effect of significantly increasing the combat power of the reconnaissance companies, and provided them with a mobile anti-tank capability. This change also tended to centralize operations at the troop level, rather than in the platoon, as doctrine advocated.

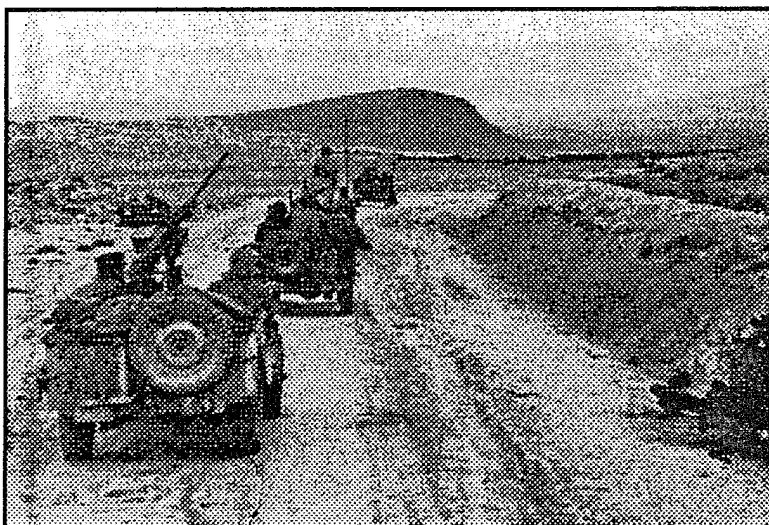

Figure 17. Reconnaissance Patrol In North Africa. Source: US Army, Photo reproduced in Kent Roberts Greenfield, editor, US Army in World War II, Pictorial Record: The War Against Germany and Italy: Mediteranean and Adacent Areas (Washington DC.: Center for Military History, 1951), 53.

North Africa demonstrated that reconnaissance units required the capability to attack and defend as a natural extension of their

reconnaissance and security missions. However, the attack and defend missions were not limited to situations associated with reconnaissance and security. From the very beginning of the campaign when a key amphibious assault objective was assigned to the dismounted 3d Reconnaissance Troop of the 3d Infantry Division,<sup>28</sup> higher commanders often and unhesitantly assigned reconnaissance units normal attack and defend missions alongside regular armor and infantry formations. Often in these roles the reconnaissance units operated as infantry, or armor, or both, depending on the situation.

An example of a reconnaissance unit attacking independent of any reconnaissance or security mission is the attack executed by the 91st Cavalry Reconnaissance Squadron (CRS) on 23 April 1943.<sup>29</sup> The 91st CRS was the only nondivisional cavalry reconnaissance unit deployed to North Africa. The unit, originally organized as the mechanized cavalry reconnaissance squadron of the 1st Cavalry Division, was the oldest and most experienced squadron size mechanized reconnaissance unit in the Army.<sup>30</sup> It, unlike most of the mechanized cavalry organizations, was relatively unaffected by the changes which occurred in cavalry in 1942, and therefore was ready for overseas deployment.

The beginning of April 1943 found the 91st CRS entering combat for the first time as a corps separate cavalry squadron attached to the 9th Infantry Division. The squadron was organized as follows: headquarters and headquarters troop, 3 reconnaissance troops, and 1 support troop (light tanks). The headquarters troop comprised 5 platoons as follows: headquarters, communications, pioneer and demolition, antitank, and maintenance and supply. Each reconnaissance

troop had a headquarters and 3 reconnaissance platoons; the support troop, a headquarters, 3 light tank platoons (5 tanks each)."<sup>31</sup> On 23 April 43 "the 91st Cavalry Reconnaissance Squadron was directed to push aggressive reconnaissance to the east within its assigned zone."<sup>32</sup> The squadron order for the "aggressive reconnaissance" follows:

Troop A push vigorous mounted reconnaissance to the east; Troop B establish observation posts on Hills 545, 562, and 445, and continue previous mission; Troop C leave vehicles (with drivers only) in the vicinity of bridge and attack dismounted in its zone, seizing and holding the forward end of the high ridge generally along the 33 grid.<sup>33</sup>

This operation was not intended to gather information, rather it was an attack to seize terrain. The initial outcome of the attack was success by Troops B and C, but Troop A was unable to "push through the German position."<sup>34</sup> At the conclusion of the day the commander of the squadron reported to division the mixed success of the day's attack. He was then informed of an impending German counterattack and received new orders. "The 91st was ordered to hold the line to which it had advanced at all costs."<sup>35</sup> Thus in the course of one day the squadron executed two missions, one a partially successful attack, and the second a defense to hold terrain gained. Neither mission was one for which the squadron was organized, trained, or equipped.

The 91st CRS's actions on 18 April were not isolated incidents resulting from attachment to an infantry division. Rather they were typical of the diverse offensive and defensive requirements commanders of all types placed on cavalry. This was reiterated on 6 May 1943, when the 91st CRS was again assigned an offensive mission. At this time the squadron was attached to the 1st Armored Division. The Division was

attempting to seize the town of Mateur, which was dominated by the Djebel Ichkeul hill mass. This position was defended by several hundred men of the Reconnaissance Battalion of the Herman Goering Division.<sup>36</sup> The squadron was given the mission of securing this high ground for use by division artillery observers. This ground was protected by an extensive swamp to the south, and steep slopes. Reconnaissance preceding the attack indicated that the terrain would not support mounted movement.<sup>37</sup>

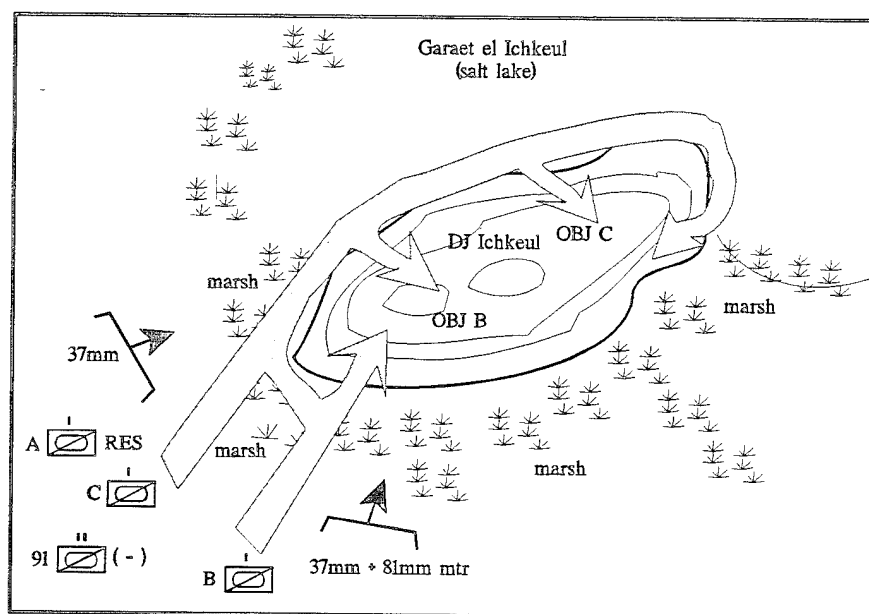

Figure 18. Attack on Djebel Ichkeul.

The squadron organized for the attack by dismounting all of its reconnaissance troops.<sup>38</sup> The tank company was detached. The attack commenced at 0700 with an artillery preparation followed by a dismounted attack by two reconnaissance troops, C on the left and B on the right. Troop A was held in reserve. The attack was supported by fire from the

organic troop mortars, the squadron 37-mm anti-tank platoon, and a division artillery battery (see figure 18). The attack ultimately required the commitment of all three troops dismounted (minus one platoon) in order to achieve success. During the attack the bulk of the squadron's vehicles sat idle, as not even the jeeps could traverse the ground. The following morning the hill was secure with the exception of snipers and the squadron received new orders. The squadron withdrew from the position, leaving one troop in place to continue to clear the snipers.<sup>39</sup>

This action demonstrates the extent to which the cavalry squadron could be required to execute missions other than that of reconnaissance. The assault on Ichkeul was a mission for an infantry battalion, but was assigned to a cavalry squadron. The extent to which mechanized cavalry was ill equipped to execute infantry type missions is illustrated by the fact that the troopers were not authorized individual entrenching tools as part of their equipment.<sup>40</sup> To dig fox holes in a situation as described above the troops had to carry their vehicle picks and shovels with them in the attack. Nonetheless, the actions of the 91st on 6 May 1943 were typical of the type of missions routinely assigned to reconnaissance elements of all sizes throughout the North African campaign.

Cavalry doctrine placed great emphasis on the platoon as the basic maneuver element. In fact, doctrine specifically stated that the troop commander might rarely see his platoons in the execution of their mission. Towards this end the platoon was designed as a semi-autonomous unit. Doctrine indicated that the typical manner of employment was as

platoon and smaller elements, executing individual, separate but coordinated reconnaissance, over large areas of ground. In actions in North Africa, this in fact occurred occasionally, though rarely with all of the reconnaissance assets of a particular battalion, squadron, or separate troop operating decentralized. However, from the examples discussed thus far, it is apparent that the reconnaissance elements often operated as troop and company entities, and frequently the majority of an entire squadron or battalion was committed in a coordinated manner toward a single objective (often not a reconnaissance objective). Thus, North Africa indicated that the scope of employment of reconnaissance units was not exclusively focused at the platoon and section level, but was often focused at the troop/company level, and frequently at the squadron/battalion level. This wide range of operational requirements was not anticipated by either doctrine or organization.

The North African campaign demonstrated that field commanders expected reconnaissance units to execute combat missions which doctrine writers prior to 1942, did not anticipate. The equipment of the reconnaissance and cavalry units was designed primarily for reconnaissance. This fact, combined with the rugged terrain, and in action against the enemy's equipment, stressed the capabilities of the equipment severely. The major items which were employed were the 75-mm assault gun, the jeep, the M3 armored car, and the M3 Stuart light tank.



Figure 19. T30, 75-mm Assault Gun. Source: US Army, Photo reproduced in Kent Roberts Greenfield, editor, US Army in World War II, Pictorial Record: The War Against Germany and Italy: Mediteranean and Adacent Areas, 132.

The assault guns of the reconnaissance platoon were probably the best weapon system in the armored reconnaissance battalion. In the words of Lieutenant Colonel Charles Hoy, Commander of the 81st ARB; "We are sold on the assault gun. It gives us poise and confidence."<sup>41</sup> These guns were designed to provide both a direct and indirect fire capability to the platoons as they operated independently, and they were very effective in this role. Frequently the assault guns were the only weapon in the platoon capable of providing the firepower the platoon needed to execute a mission. The guns were often massed to provide quick and responsive direct or indirect fire support to a company. Frequently they saved the day as in the case of the withdrawal under the

protection of the massed company assault guns by Company A, 81st ARB at Station de Sened. They were one of the few weapons, and the only one organic to reconnaissance units, capable of dealing effectively with German medium tanks.

The other extremely successful, and very popular, system in the reconnaissance units was the jeep. The jeep was reliable, rugged, and most importantly, small enough to go almost anywhere (the actions of 91st CRS described previously being a notable exception). In one instance, LTC Candler of the 91st CRS, hiked to an observation post on a rugged hill top position and determined that it could only be reached dismounted. As he finished his inspection he was greeted by the first jeep of his lead platoon arriving on top of the position.<sup>42</sup> The mobility of the jeep was its most remarked upon feature, particularly in the rugged expanses of North Africa. It was also small and offered a low silhouette making it difficult to spot.<sup>43</sup> The jeep had its drawbacks, the primary one being its vulnerability to enemy fire and mines. Crews typically sandbagged the floors and this resulted in some lives being saved, but the jeep was recognized as not being a combat vehicle.<sup>44</sup> The other problem with the jeep was its difficulty handling the weight of the .50 caliber machine ammunition.<sup>45</sup> The machine-gun itself, however, "was easily and quickly positioned to fire on German machine gun positions."<sup>46</sup> In general, however, as a light scout vehicle (and the replacement of the motorcycle) the jeep exceeded all expectations.

On the other hand, the M3 White armored car did not live up to expectations. The vehicle was found to be under powered and therefore



its cross country mobility, and grade climbing ability were significantly reduced.<sup>47</sup> It was also too large to negotiate many of the smaller trails and paths which reconnaissance units used to by-pass enemy positions and traverse rugged terrain. The fire power of the .50 caliber and .30 caliber machine-guns were very effective against infantry but not at all effective against the light or medium armor frequently encountered. The open top made the vehicle vulnerable to artillery, and a "grenade trap".<sup>48</sup> The M3's short comings resulted in frequent separation of the armored cars from the scout cars. This made it impossible to employ the armored cars to protect the scout cars (jeeps) as doctrine required, and reinforced the primary liability of the jeep - protection. According to the commander of the 91st CRS, Lieutenant Colonel Harry Chandler, the "scout car's chief usefulness was as a means of transport for the radio communications between platoons and troops and troops and squadron."<sup>49</sup> The M3 demonstrated more utility as a communications vehicle than in its intended role of armored reconnaissance.

The M3 Stuart light tank was the mainstay of not only the reconnaissance forces but also a large portion of the armored units as well (each armored regiment had an entire battalion of light tanks). As indicated earlier, at the time of its development it was a fairly capable vehicle, but by the time of its employment by US forces in North Africa light tanks had been supplanted by mediums as the predominant force on the armored battlefield. It was quick, agile, and reliable, but its 37-mm gun was ineffective against the frontal armor of medium tanks.<sup>50</sup> Because of this, the Stuart's performance in combat was

marginal. The Stuart did very well against light armored vehicles, machine guns, and infantry - the enemies most frequently encountered by the reconnaissance units. Thus, although North Africa demonstrated that the 37-mm gun was inadequate against medium tanks, the consequence of this shortcoming was not yet fully recognized, and the Stuart's utility continued to be rated fairly high by the Army.

The organizational structure of reconnaissance units in North Africa was generally adequate to support the successful accomplishment of missions. However, several organizational peculiarities were demonstrated by combat. The tank company/troop in the battalion and squadron was often not in position to support the reconnaissance companies/troops. The impact of this was that reconnaissance units fought armor without the support of their own armor as in the cases of Companies A and C of the 81st ARB during their security missions south and west of Sidi-Bou-Zid in February 1943. After Kasserine, this was remedied by the frequent task organization of tank platoons to reconnaissance troops/companies as was done in both the 81st ARB and the 91st CRS. The 81st made this task organization permanent when it experienced an officer replacement shortage in March of 1943.

The other organizational alteration which was frequently made was the consolidation of the platoon assault guns into mini batteries of three guns under company control. This maximized their fire power and improved fire coordination. This was a typical task organization when the company was employed as a whole, which frequently occurred. Task organization of assault guns, combined with the attachment of a tank platoon made possible the successful attack of Company C, 81st ARB,

north of Gafsa in March 1943. Battle experience indicates that the troop became the basic fighting element in the reconnaissance units in North Africa, rather than the platoon, and that additional combat power usually was consolidated there.

#### Lessons Learned

At the conclusion of the African campaign in May 1943, the Army, Army Ground Forces, and especially, the Cavalry School, all recognized that a wealth of combat lessons learned regarding reconnaissance doctrine, organizations, and equipment were now available. They quickly and systematically began to formalize these insights, incorporate them into the Army doctrine and structure, and distribute them to the field. The requirement was to accomplish this prior to the next major combat involving reconnaissance units. They did not know that this was barely a year away, but they certainly understood that time was critical. The influence of the combat experience in reconnaissance acquired was reflected in the cavalry's professional journal, in training circulars and field manuals, and in new tables of organization and equipment.

The most critical lesson learned from the North African experience regarded the validity of doctrinal concepts as demonstrated on the battlefield. Heretofore, the priority mission had clearly been reconnaissance, and the accepted technique stealth. It is clear that in North Africa reconnaissance became only one of many missions executed by cavalry and reconnaissance units, and that direct combat was common.

Major General Charles Scott, Commander of the Armor Replacement Center at Fort Knox, was assigned as the senior officer of the US

military delegation in the Middle East from March to July 1942.<sup>51</sup> In November 1942 he wrote in the Cavalry Journal regarding reconnaissance doctrine and combat based on his observations in the Middle East:

It is apparent that weak reconnaissance can get nowhere on its mission against this much stronger opposition. On the other hand, on many occasions it will be overrun and destroyed before it can obtain any information of value. Also, on occasions in the desert, it was not even possible for weak reconnaissance to pause only enough to send in valuable information that had been collect, and it was not unusual to see light, long distance reconnaissance piling back just ahead of a strong attack.

In this day and age, long distance reconnaissance must be organized to fight in execution of its mission, to fight for time to send information in, and to fight for time for the main body to utilize properly the information sent in.<sup>52</sup>

It appears that comments such as these from someone as influential as General Scott, one of the armor force's pioneers, would go a long way to settling the issue. In contrast, writing in response in the Cavalry Journal was Lieutenant Colonel Bruce Palmer and Lieutenant Colonel Hoy:

Beware of that misused word 'fire power.' Don't tie a reconnaissance unit down with tanks, 81-mm mortars, 37 SP guns, because it makes the unit too unwieldy and few officers can take care of all those additions and still do the job of gathering information. Understand me, I am in complete accord with General Scott's statement that "Reconnaissance capable of only observation is not worth the road space it takes." The reconnaissance units should have sufficient fire power, but too much is as bad as too little. Anyone in a reconnaissance unit who is not primarily a reconnaissance man must be there for a very good reason. If I get the armored car, then I don't want the light tank.<sup>53</sup>

In a separate article Colonel Hoy specifically stated:

Ordinarily, a reconnaissance unit will not fight for its information. This does not mean that it need not be aggressive. It takes 'guts' and drive to slip past the enemy, get behind him, and stay there transmitting information. But reconnaissance by fire should not be used promiscuously.<sup>54</sup>

Thus Hoy continued as a strong advocate of the doctrine which was developed prior to the war, and which his battalion attempted to execute in North Africa. As a successful reconnaissance battalion commander in combat, and a member of the Cavalry School faculty, Lieutenant Colonel Hoy was in a position to influence future reconnaissance doctrine and organizations.

Both the comments of General Scott and Colonel Hoy were unofficial, but they indicate the different interpretations of reconnaissance lessons present in the Army following the North African campaign. General Scott's view is the traditional cavalry view which harkens back to the doctrine envisioned prior to the creation of the Armored Force. This view saw the cavalry as a mobile, lethal, all purpose combat force capable of performing many missions, one of which is reconnaissance. Colonel Hoy's view is the revisionist view of cavalry: a force optimized to perform reconnaissance by employing speed, maneuver and stealth. Events in North Africa supported the position of General Scott. Army official publications and actions after the African campaign were a compromise of the two. Stealth remained a primary technique of reconnaissance, but the use of fire and movement to gain information also appeared in doctrinal literature from 1943 on.

In 1943 and early 1944 the Army issued a number of publications which indicated that the role of the Army's reconnaissance units, particularly at the battalion and squadron level, was changing. The first publication was FM 2-30, Cavalry Mechanized Reconnaissance Squadron, published in April of 1943. This manual was written for the cavalry reconnaissance squadron of the cavalry and motorized infantry

divisions. As it came to pass, these units never were fielded. Nonetheless, the manual was the only battalion and squadron level reconnaissance doctrine published during the war. It was published prior to the completion of the North African campaign, but demonstrates that some of General Scott's views of reconnaissance and combat were being reflected in doctrine prior to the end of the campaign.

FM 2-30 continued to state the basic premise of all previous reconnaissance doctrine, that reconnaissance "...seeks to flow around or infiltrate through such obstacles as hostile counterreconnaissance or security groups by means of stealth and to reach the enemy main body."<sup>55</sup> However, in a number of passages the manual specifically recognized the importance of combat to successful reconnaissance:

When the advance of its detachments is arrested by enemy action, necessary pressure is applied at a weak point by the use of reserve elements to penetrate the resistance and expose the enemy dispositions to continued reconnaissance.<sup>56</sup>

The cavalry reconnaissance squadron may engage in offensive combat as an incident in the execution of any mission which it is assigned. On reconnaissance, individual patrols will have frequent engagements with hostile groups. The squadron may find itself opposed by a counterreconnaissance screen around whose flanks it cannot side step and be confronted by the necessity of executing a penetration. A point usually will be reached at which it will be necessary to attack a covering force in order to develop so much of a situation as will reveal the strength and attitude of the enemy.<sup>57</sup>

Although previous doctrine, FM 2-10 Volume II, Employment of Mechanized Cavalry, 1941, recognized that occasionally combat was necessary, FM 2-30 is far more permissive. The 1943 manual indicates that combat will be unavoidable: "It is to be expected that the squadron must fight at some time in the execution of any mission it may be assigned."<sup>58</sup> The

manual further states that "the outstanding combat characteristics of the squadron are its great fire power and extreme mobility."<sup>59</sup> FM 2-30 indicates that even as Colonel Hoy's 81st Reconnaissance Battalion was trying to practice the infiltration reconnaissance doctrine developed prior to the war, the cavalry school was beginning to recognize that combat was an integral part of effective reconnaissance.

The most important doctrinal issue addressed in FM 2-30 was security. The manual stated:

When it becomes necessary for the division commander to assign a primary mission of security, the operations of the squadron are typical of cavalry. Reconnaissance tactics are employed to gain and transmit timely information of the enemy. Other elements (support troop, antitank platoon, pioneer and demolition platoon) cooperate with the reconnaissance elements and, using the technique of harassing and delaying action, block the routes of hostile approach to gain time for the main body.<sup>60</sup>

This describes the intent of the 81st ARB mission at Sidi-Bou-Zid in February 1943, and goes far beyond the previous doctrine which considered the primary task of security to provide early warning.

In September 1943, Headquarters Army Ground Forces published a training circular on mechanized cavalry, TC 107, "Employment of Mechanized Cavalry." This training circular was designed to inform the Army of doctrinal lessons learned regarding mechanized cavalry, and was an official attempt to disseminate doctrinal information from the African campaign quickly, rather than await the publishing of a manual. TC 107 reinforced many of the ideas expressed in FM 2-30. It advocated attacking to reduce obstacles,<sup>61</sup> and it specifically stated that the mechanized cavalry squadron had sufficient combat power to engage in offensive and defensive missions to conduct reconnaissance.<sup>62</sup> Like FM

2-30, however, TC 107 also stated that infiltration tactics were still the prime means of conducting reconnaissance.<sup>63</sup>

The most significant doctrinal publication issued after the North African campaign, was FM 2-20, Cavalry Reconnaissance Troop, Mechanized, published in January 1944. This manual was the definitive reconnaissance doctrinal publication through the conclusion of the war. Unlike FM 2-30, FM 2-20 was written specifically for the cavalry troop organization that was adopted in September 1943 and fielded in Europe from the time of the Normandy invasion through VE Day. The manual was a clear expression of the World War II Army's view of reconnaissance.

The key statement in FM 2-20 indicating the final evolution in the Army's view of combat and reconnaissance is "The troop employs infiltration tactics, fire, and maneuver to accomplish reconnaissance missions."<sup>64</sup> This statement, for the first time since the publication of the mechanized reconnaissance doctrine in 1933, establishes the position that infiltration is not the only method for accomplishing reconnaissance. FM 2-20 makes the techniques of fire and maneuver, indicating combat, doctrinally sanctioned for the conduct of reconnaissance. It specifically said "The reconnaissance troop of the squadron, normally reinforced with assault guns, and with light tanks when their use is anticipated, is prepared to fight for information if necessary to the accomplishment of reconnaissance missions."<sup>65</sup> Infiltration is still also a technique, but it was no longer the preferred technique. The manual captures the combat lessons of North Africa, and recognized the likelihood that security, defensive, and offensive missions were executed outside the context of reconnaissance:



"Elements of the reconnaissance troop may be required to defend observation posts, bridges, or defiles, in order to accomplish reconnaissance missions. Enemy attack may necessitate defensive action in other instances."<sup>66</sup> Regarding offensive action: "The unit attacks when reconnaissance indicates that the enemy position can be taken with the means available."<sup>67</sup>

FM 2-20 also reflected many of the tactics, techniques, and procedures learned in Africa. Although it was intended as a troop manual, it discussed in detail the utilization of tanks and assault guns. The manual emphasized task organizing the troop with both systems. In the case of the tank, the manual stated:

The troop may be supported by the light tank company, the latter providing combat power to overcome minor opposition. The light tank company may be attached as a unit or by platoons to the reconnaissance elements when the squadron front is so broad, or the terrain so difficult, that reserves cannot be moved readily to all parts of the squadron zone. Attachment also may be made when hostile resistance can be foreseen.<sup>68</sup>

In the case of the assault gun, it indicated the following:

The troop employs the attached assault guns to support reconnaissance platoons by placing smoke or HE concentrations on organized enemy positions, thereby permitting side-slipping and infiltration by reconnaissance elements.<sup>69</sup>

The assault gun platoon, consisting of a platoon headquarters, two assault gun sections (one assault gun each), and an ammunition section, operates under reconnaissance troop control. Usually held, with one reconnaissance platoon, in troop reserve.<sup>70</sup>

FM 2-20 made task organization of the troop for combat a cornerstone of doctrine.

In regards to the security mission, the manual did not reflect the critical importance of security missions for higher headquarters.

FM 2-20 states "The troop contributes to the security of the division by reporting the location of enemy forces and by giving timely warning of ground and air attacks."<sup>71</sup> This is an expression of the troop's capabilities in regards to security. It indicates that the troop, by itself, can provide no more security than early warning. This does not contradict the squadron capabilities and role described in FM 2-30, and is a realistic appraisal of the troop's capability.

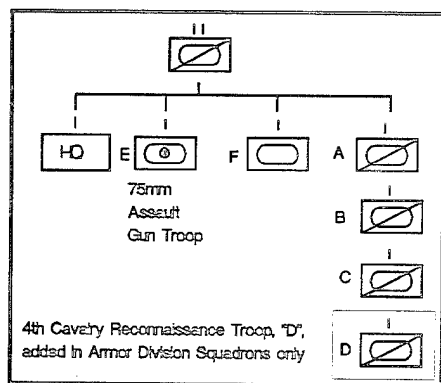

Figure 20. Cavalry Reconnaissance Squadron, 1943. Source: War Department, TO&E 2-25, Cavalry Reconnaissance Squadron, Mechanized (Washington D.C: War Department, September 1943), 2-3.

The final significant Army response to the lessons learned from Africa was the decision in June 1943 to standardize all mechanized reconnaissance formations in the Army as cavalry reconnaissance units. The reconnaissance battalions of the armored divisions were redesignated as cavalry reconnaissance squadrons.<sup>72</sup> In addition, a new table of organization and equipment was adopted in September which standardized all mechanized cavalry troops and squadrons throughout the Army.<sup>73</sup>

The new troop and squadron organizations were adopted based on lessons learned in Africa, and sought to standardize reconnaissance units, adopting the best features of the armored reconnaissance battalion and the cavalry reconnaissance squadron (see figure 20).<sup>74</sup> The new organization recognized the superb performance of the jeep and its effectiveness as a reconnaissance vehicle by increasing the number from four to six in the platoon (see figure 21).<sup>75</sup>

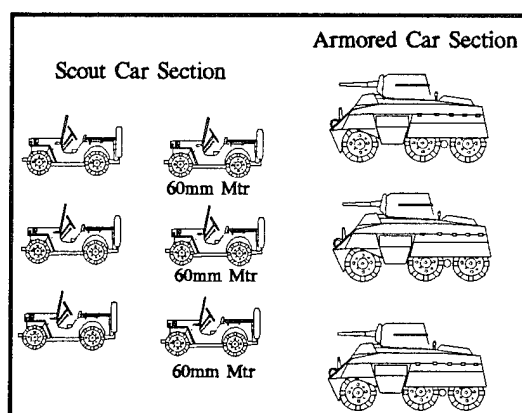

Figure 21. Cavalry Reconnaissance Platoon, 1943. Source: War Department, T/O &E 2-27 (1943), 2-3.

The dissatisfaction with armored car was noted and the number was reduced in each platoon from four to three. The effectiveness of the assault gun was also understood, as well the frequent consolidation of the weapon systems in combat. This resulted in the standardization of an assault gun troop in the squadron (eliminating the individual gun in the reconnaissance platoon of the armored reconnaissance battalion). Finally the importance of tanks to reconnaissance was validated by the retention of the light tank company.

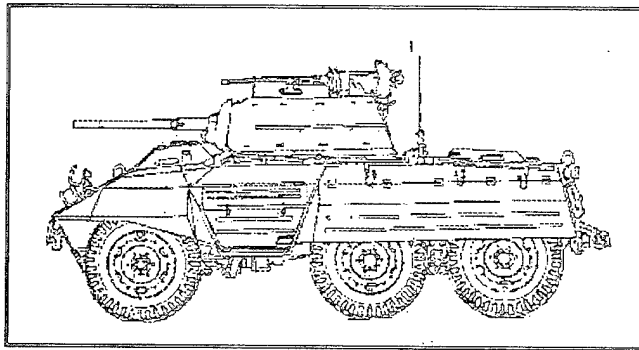

Figure 22. M8, Armored Car, "Greyhound." Source: Military Modeler, Drawing from "M8 Greyhound," Military Modeler (April, 1986): 33.

The last significant change made in Army mechanized cavalry after the North African Campaign was the fielding of new equipment. This resulted in the replacement of M3 White armored car by the M8 Gray Hound. The M8 was a large, 6X6 wheeled vehicle, mounting a 37-mm antitank in an open turret. It was originally designed by the Tank Destroyer Force as a 37-mm antitank gun motor carriage, but was adopted by cavalry due to its availability and the significant shortcomings of the M3 White Armored Car.<sup>76</sup> The M8, however, was not a great vehicle, merely an improvement over what was previously on hand. Before the M8 was committed to combat in any numbers, FM 2-20 warned that the "armor of the vehicle provides a fair degree of protection against small arms, while the 37-mm antitank gun permits mobile defense against lightly armored vehicles, [however] the vehicle is not designed for offensive combat. The car has only fair mobility across country. Mobility is limited in heavily wooded areas and on broken terrain. The larger turning radius and limited mobility across country make the car susceptible to ambush on roads and in defiles."<sup>77</sup> This vehicle would

be the mainstay of the cavalry force through the rest of the war (see figure 22).

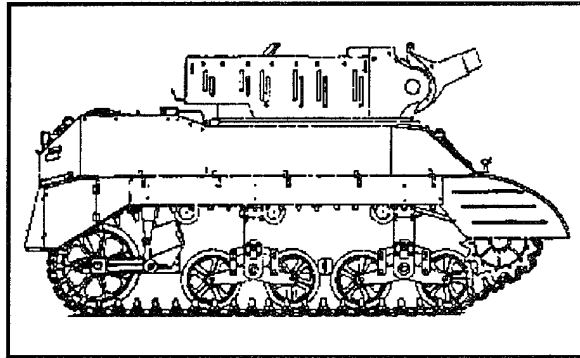

Figure 23. M8, 75-mm Assault Gun. Source: Military Modeler, Drawing from "Viva La Difference," Military Modeler (May 1988): 49.

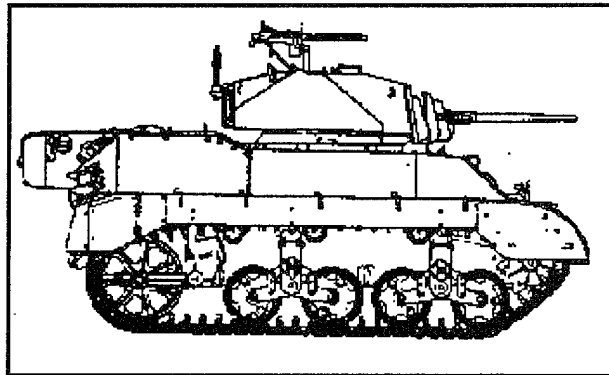

Figure 24. M5A1, Light Tank. Source: Military Modeler, Drawing from "Temporary Residence," Military Modeler, (August 1991): 15.

In addition to the M8 armored car, new assault guns and a new tank arrived in units. The half-tracked assault gun was replaced by the M8 Howitzer Motor Carriage. This system employed a 75-mm howitzer on a fully tracked and armored light tank chassis (see figure 23). The M3 light tank was replaced by the M5 light tank. The M5 had a more

powerful power plant, thicker armor, and was easier to drive than the M3. Otherwise, it was essentially the same vehicle, including as its main armament the 37-mm gun (see figure 24).<sup>78</sup> The major contributions of all these new systems was to increase mobility, protection, and fire power of the platoons and troops. The impact of these capabilities was units better capable of combat.

The North African campaign provided the reconnaissance force of the US Army the opportunity to test its doctrine, organization, and equipment. The results of that testing indicated that there were several fundamental flaws in reconnaissance doctrine. These flaws were the overemphasis on stealth and avoiding combat, and the lack of recognition of the importance of combat and combat related missions. Combat experience demonstrated that effective reconnaissance required fighting. It also demonstrated that reconnaissance units were required to conduct many tasks other than reconnaissance. These tasks included the traditional missions of cavalry outlined in FM 2-15, 1941: offensive combat; defensive combat; security for other arms; and special operations such as mobile reserve, filling gaps, and liaison.<sup>79</sup>

The basic organization of the reconnaissance units was found to be fundamentally sound. Combat did show, however, that company/troop and battalion/squadron level organizations often operated as complete units contrary to the expectations of doctrine which emphasized independent platoon operation. Battle experience indicated the reliability and effectiveness of the jeep and the assault gun. It also indicated the inferiority of the M3 armored car, and the adequacy of the light tank.

The Army adjusted rapidly to the North African experience. Within a year doctrine, organizations, and equipment were evaluated and changes issued to units in the field. The swift effort to correct reconnaissance doctrine was largely successful. The combination of FM 2-20 and FM 2-30, as well as TC 107, emphasized the integral relationship between combat and reconnaissance, and advanced numerous battlefield techniques (such as task organizing the troop for combat) based on combat experience. The shortcoming of the revised doctrine, however, was its prevailing emphasis on reconnaissance, to the detriment of other combat missions which proved very common in North Africa.

Improving the tables of organization and equipment made the already effective cavalry organizations even more flexible. Equipment was improved and upgraded in all areas. The most important equipment addition was the M8 armored car replacing the inadequate M3.

Thus, by the spring of 1944 all mechanized reconnaissance forces were again consolidated in the cavalry. They were prepared to execute an aggressive doctrine which emphasized reconnaissance through a combination of stealth, fire, and maneuver. How effectively the combat messages of North Africa were perceived, and acted upon, was exhaustively tested in combat for eleven months as World War II entered its final stage beginning in June 1944.

#### Endnotes

<sup>1</sup>US Army Cavalry School, Cavalry Reconnaissance, Number Three: Operations of the 91st Cavalry Reconnaissance Squadron, Mechanized, From El Abiod to Mateur (Fort Riley KS: US Army Cavalry School, 1944), 1.

<sup>2</sup>War Department, TO 17-37, Reconnaissance Company, Armored Regiment or Armored Reconnaissance Battalion (Washington D.C.: War Department, 1942), 2.

<sup>3</sup>US Army Cavalry School, Cavalry Reconnaissance, Number One: Operations of the 81st Armored Reconnaissance Battalion in Tunisia (Fort Riley KS: US Army Cavalry School, 1944), 1.

<sup>4</sup>Ibid., 5.

<sup>5</sup>Ibid., 3.

<sup>6</sup>Ibid., 5-7.

<sup>7</sup>Ibid., 7.

<sup>8</sup>Ibid., 99.

<sup>9</sup>War Department, FM 2-15, Cavalry Field Manual, Employment of Cavalry (Washington D.C.: US Government Printing Office, 1941), 5.

<sup>10</sup>Ibid., 102.

<sup>11</sup>War Department, FM 100-17, Field Service Regulations for Larger Units (Washington D.C.: Government Printing Office, 1941), 41.

<sup>12</sup>George F. Howe, The Battle History of the 1st Armored Division, "Old Ironsides" (Washington D.C.: Combat Forces Press, 1954), 146.

<sup>13</sup>US Army Cavalry School, Cavalry Reconnaissance, Number One: Operations of the 81st Armored Reconnaissance Battalion in Tunisia, 20.

<sup>14</sup>Ibid., 21.

<sup>15</sup>Howe, The Battle History of the 1st Armored Division, "Old Ironsides," 148.

<sup>16</sup>Ibid., 149-150.

<sup>17</sup>Howe, George F., US Army in World War II, Northwest Africa: Seizing the Initiative in the West (Washington D.C.: Center for Military History, 1957), 413.



<sup>18</sup>US Army Cavalry School, Cavalry Reconnaissance, Number One: Operations of the 81st Armored Reconnaissance Battalion in Tunisia, 24.

<sup>19</sup>Howe, The Battle History of the 1st Armored Division, "Old Ironsides.", 168.

<sup>20</sup>US Army Cavalry School, Cavalry Reconnaissance, Number One: Operations of the 81st Armored Reconnaissance Battalion in Tunisia, 24.

<sup>21</sup>US Army Cavalry School, FM 2-10, Cavalry Field Manual: Mechanized Elements (Fort Riley, KS: US Army Cavalry School, 1941), 66-67.

<sup>22</sup>US Army Cavalry School, Cavalry Reconnaissance, Number Two: Operations of the 81st Armored Reconnaissance Battalion in Tunisia (Fort Riley, KS: US Army Cavalry School, 1944), 20.

<sup>23</sup>Ibid., 23.

<sup>24</sup>Ibid., 23.

<sup>25</sup>Ibid., 23-25.

<sup>26</sup>US Army Cavalry School, FM 2-10, Cavalry Field Manual: Mechanized Elements (1941), 55.

<sup>27</sup>US Army Cavalry School, Cavalry Reconnaissance, Number Two: Operations of the 81st Armored Reconnaissance Battalion in Tunisia, 19.

<sup>28</sup>Howe, US Army in World War II, Northwest Africa: Seizing the Initiative in the West, 128.

<sup>29</sup>US Army Cavalry School, Cavalry Reconnaissance, Number Three: Operations of the 91st Cavalry Reconnaissance Squadron, Mechanized, From El Abiod to Mateur, 12.

<sup>30</sup>The Cavalry Journal, "C.O.'s of Cavalry Units," The Cavalry Journal (July-August, 1941): 110.

<sup>31</sup>US Army Cavalry School, Cavalry Reconnaissance, Number Three: Operations of the 91st Cavalry Reconnaissance Squadron, Mechanized, From El Abiod to Mateur, 1.

<sup>32</sup>Ibid., 12.

<sup>33</sup>Ibid., 12.

<sup>34</sup>Ibid., 12-13.

<sup>35</sup>Ibid., 13.

<sup>36</sup>Howe, US Army in World War II, Northwest Africa: Seizing the Initiative in the West, 655.

<sup>37</sup>US Army Cavalry School, Cavalry Reconnaissance, Number Four: Operations of the 91st Cavalry Reconnaissance Squadron, Mechanized, From El Abiod to Mateur (Fort Riley, KS: US Army Cavalry School, 1944), 1.

<sup>38</sup>Ibid., 3.

<sup>39</sup>Ibid., 7.

<sup>40</sup>US Army, Army Ground Forces, "Report, Subject: Extract from Overseas Reports, Immediate Report No. 55" (Washington D. C.: Headquarters, Army Ground Forces, Army War College, 11 Oct 44), 3.

<sup>41</sup>Charles J. Hoy, "Reconnaissance Lessons From Tunisia," in Modern Reconnaissance, ed. The Cavalry Journal (Harrisburg: The Military Service Publishing Company, 1944), 115.

<sup>42</sup>US Army Cavalry School, Cavalry Reconnaissance, Number One: Operations of the 81st Armored Reconnaissance Battalion in Tunisia, 7.

<sup>43</sup>US Army Cavalry School, FM 2-20, Cavalry Reconnaissance Troop, Mechanized (Fort Riley KS: US Army Cavalry School, 1944), 4-5.

<sup>44</sup>Ibid., 4-5.

<sup>45</sup>Harry W. Candler, "91st Reconnaissance Squadron in Tunisia - A Detailed Study," in Modern Reconnaissance, 174.

<sup>46</sup>Ibid., 175.

<sup>47</sup>J. M. Boniface, US Army Vehicles of World War Two (Somerset: Haynes Publishing Co., 1991), 184.

<sup>48</sup>Ibid., 184.

<sup>49</sup>Candler, 173.

<sup>50</sup>Charles, M. Baily, Faint Praise, American Tanks and Tank Destroyers during World War II (Hamden: Archon Books, 1983), 60.

<sup>51</sup>Charles L. Scott, "Armored Reconnaissance," in Modern Reconnaissance, 20.

<sup>52</sup>Ibid., 22.

<sup>53</sup>Bruce Palmer, "Battle Lessons on Reconnaissance," in Modern Reconnaissance, 114.

<sup>54</sup>Hoy, 129.

<sup>55</sup>US Army Cavalry School, FM 2-30, Cavalry Field Manual, Cavalry Mechanized Reconnaissance Squadron ( Fort Riley KS: US Army Cavalry School, 1943), 19.

<sup>56</sup>Ibid., 19.

<sup>57</sup>Ibid., 65.

<sup>58</sup>Ibid., 55.

<sup>59</sup>Ibid., 65.

<sup>60</sup>Ibid., 48.

<sup>61</sup>US Army, Army Ground Forces, TC 107, "Mechanized Cavalry" (Army War College: Headquarters, Army Ground Forces, 1943), 2.

<sup>62</sup>Ibid., 6.

<sup>63</sup>Ibid., 3.

<sup>64</sup>US Army Cavalry School, FM 2-20, Cavalry Reconnaissance Troop, Mechanized, 17.

<sup>65</sup>Ibid., 94.

<sup>66</sup>Ibid., 81.

<sup>67</sup>Ibid., 66.

<sup>68</sup>Ibid., 87.

<sup>69</sup>Ibid., 88.

<sup>70</sup>Ibid., 88.

<sup>71</sup>Ibid., p. 36.

<sup>72</sup>Greefield, 331.

<sup>73</sup>War Department, TO&E 2-25, (1943), 1.

<sup>74</sup>Ibid., 2.

<sup>75</sup>War Department, TO&E 2-27, Cavalry Reconnaissance Troop, Mechanized (Washington D.C: War Department, September 1943) 2.

<sup>76</sup>B. T. White, Tanks and Other Fighting Vehicles, 1942-45 (England: Balandford Press, Dorset, 1975), 110.

<sup>77</sup>US Army, Cavalry School, FM 2-20, Cavalry Reconnaissance Troop, Mechanized, 4.

<sup>78</sup>B. T. White, 98.

<sup>79</sup>War Department, FM 2-15, Cavalry Field Manual, Employment of Cavalry, 5.

## CHAPTER FOUR

### COMBAT AND POST WAR REVIEW 1944-1945

In June 1944 the United States Army and its allies, executed the long awaited cross channel invasion beginning the final stage of World War II. Cavalry units, organized in corps cavalry groups, separate squadrons and divisional squadrons and troops, played a key role in the European Campaign and tested their evolving doctrine and associated organization and equipment. The course of operations in Europe demonstrated that published cavalry doctrine still did not meet the requirements of the battlefield. Doctrine did not address the breadth of the tactical missions that cavalry was required to perform, nor did it hint at the operational role cavalry played in the theater.

Until the campaigns in Northwest Europe, the United States Army had only limited opportunities to execute multiple corps operations. These had been in the restricted maneuver space of Sicily and Italy where the conditions of terrain and enemy had severely limited the ability to employ mechanized forces and fight a war of maneuver. The European campaign was different. Generally open or mixed terrain with few significant mountain ranges, it was ideal for mounted maneuver. Events would also provide operational and tactical opportunities to employ mechanized cavalry in a wide variety of roles and missions. What these roles and missions were, and how well cavalry fulfilled them would be the final test of World War II cavalry doctrine, organization,

and equipment. The result would become the corner stone of the US Army's view of cavalry for the next fifty years.

The previous chapters described mechanized cavalry doctrine as it was written prior to the war, executed in North Africa, and then adjusted prior to the Normandy landings. The nature of the campaigns prior to 1944 focused the Army's doctrinal analysis at the tactical level. The campaigns in Northwest Europe continued to refine the tactical doctrine of cavalry, but they also provided, for the first time in the war, the Army the opportunity to demonstrate how mechanized cavalry should be employed at the operational level of war.

The operational level of war fights campaigns using as its primary elements field armies and corps. During World War II a US field army or corps commander had a variety of tools to utilize to fight his unit in the form of independent combat, combat support, and service support units. Unique among the corps and army troops, and one of the most valuable, was the cavalry group.

General Lesley McNair, Chief of Army Ground Forces, conceived the group concept as an economical and flexible means of organizing corps and higher units to replace the regimental system that existed prior to 1942. <sup>1</sup> The cavalry group consisted of a group headquarters and headquarters troop but no other assigned units. Two cavalry reconnaissance squadrons were attached to each group. Depending on the mission and situation the corps or army commander could tailor the group organization by adding additional squadrons, other combat units, and additional combat support and service units as required. Within a month of the June 6, 1944 landings, two cavalry groups arrived to support the

operations of the First US Army, the 4th and the 106th Cavalry Groups. With the activation of the Third Army in August 1944, the 3d, 2d and the 6th Cavalry Groups were committed to combat. By May 1945 a total of thirteen cavalry groups were in combat in Europe.

FM 2-15, Employment of Cavalry, dated 1941, FM 100-5, Field Service Regulations, dated 1944, and FM 100-17, Field Service Regulations for Larger Units, dated 1942, were the primary doctrinal guides available to senior officers (corps and army commanders and their staffs) on how to employ cavalry in support of other Arms. As discussed in Chapter 2, FM 2-15 was written for a horse mounted cavalry organization that used armored cars and a small number of tanks to conduct reconnaissance for horse units. The manual primarily focused on employment of the horse cavalry division and regiment, discussing mechanized cavalry only in a reconnaissance or supporting role for horse units.

Two versions of FM 100-5 were used by the Army in World War II. The first was published in 1941, just prior to the start of the war, and the other was published at the time of the Normandy invasion, June 1944. Surprisingly, with regard to cavalry, the 1944 version did not differ significantly from the 1941 edition. It did not recognize mechanized cavalry as an equal partner to horse cavalry, judging the value of the former as chiefly in reconnaissance. It did not reflect the reality or the combat experience of the mechanized cavalry force of 1944, but persisted to discuss horse cavalry at length.<sup>2</sup> The only concession to the combat lessons regarding reconnaissance and mechanized cavalry learned in Africa in 1943 was the inclusion of fire and maneuver as

additions to stealth, as techniques that mechanized cavalry utilized to conduct reconnaissance. <sup>3</sup> The manual did reflect, however, the general knowledge of cavalry employment on the part of the senior leadership in Army and in Europe. FM 100-17 did not discuss cavalry at all except to refer the reader to FM 100-5.

How cavalry was employed depended on the senior leadership of the Army, primarily the corps commanders who had operational control of the cavalry groups. Cavalry groups were Army assets which were normally allocated one per corps. Corps commanders and their staffs were generally not cavalymen themselves and relied on FM 2-15 and FM 100-5 as their doctrinal references. In the absence of horse cavalry, commanders and staffs applied traditional cavalry missions as outlined in FM 2-15 and FM 100-5 to the mechanized cavalry groups under their control.

The 1941 version of FM 2-15 was MG John Herr's vision of how to fight horse cavalry at the regimental level and higher. In particular, it focused on the role of large cavalry formations on the battlefield. Its most basic tenet was that "the primary mission of Cavalry is combat."<sup>4</sup> It outlined specific operational missions of cavalry as defensive, offensive, reconnaissance, security, liaison, and special operations.<sup>5</sup> This was in accordance with FM 100-5, 1944, which stated the role of cavalry was attack, pursuit, holding critical objectives, and special operations.<sup>6</sup> This in fact is how cavalry was employed in the European theater of operations. The difference between doctrine and reality however, was that rather than horse cavalry regiments executing



the cavalry doctrine, in 1944 and 1945 it was mechanized cavalry groups and squadrons.

Post war analysis indicates some startling realities regarding the missions given to cavalry groups in the European theater during World War II. Reconnaissance, the mission originally envisioned for mechanized cavalry made up only 3% of cavalry group operations (as measured in number of days committed to combat). In contrast, defense, probably the mission for which mechanized cavalry was least well equipped and organized, was executed 33% of the time. The analysis also revealed that special operations (29%), offensive (10%), and security missions (25%) were also conducted more often than reconnaissance. In armored divisions the cavalry squadron performed reconnaissance missions only slightly more often (13%).<sup>7</sup>

#### Defense

Cavalry groups executed defensive missions more often than any other mission. FM 15-2 indicated that cavalry would only be used for limited defense until it could be relieved by other arms.<sup>8</sup> In fact cavalry groups not only defended often, they defended the same positions for long periods of time, sometimes for several months. Defensive missions were specifically terrain oriented, as opposed to security missions which were oriented on protecting another friendly force, and used many combinations of defensive and offensive techniques to accomplish that purpose. Cavalry proved to be a very effective force for defensive missions.

There were legitimate operational reasons why mechanized cavalry was used for defensive operations. One reason was the general shortage of infantry experienced by the Army during the European campaign. This shortage was so severe that General Patton twice levied his rear echelon units for infantry replacements.<sup>9</sup> The units best equipped in terms of fire power and training to replace infantry were cavalry groups, particularly in defensive situations that were considered low risk. Cavalry weapon systems permitted a single cavalry platoon to put out more automatic weapons and cannon fire than an entire infantry company. At the same time cavalry had the capability and training to dismount and dig in like infantry. The unit's mobility, combined with its ability to operate dismounted, made it appear larger than it was, and provided a combat appearance similar to that of an infantry unit. Finally, its command and control capability (measured in terms of numbers, distribution, and range of radio systems) was greatly superior to that of an equivalent infantry unit. For all these reasons, in defensive situations cavalry was frequently substituted for infantry.

All of these characteristics were reinforced by FM 2-15, which indicated that cavalry was capable of attacking and defending dismounted.<sup>10</sup> It is doubtful that higher commanders recognized that FM 2-15 intended dismounted combat for horse cavalry only, and that it was not doctrinally advocated for mechanized cavalry by either squadron or troop doctrine in FM 2-30 or FM 2-20. The reality in the European theater was that commanders did not have enough infantry and felt that cavalry were the best substitute, and used them in this role often.

Another reason cavalry was used to replace infantry in defensive situations was the desire of commanders to mass combat power at the decisive point on the battlefield. Cavalry was ideally suited to covering disproportionately large areas of ground due to its mobility, automatic weapons fire power, command and control capability, and combined arms characteristics. This permitted corps and army commanders to execute operations in accordance with the principles of economy of force and mass. By substituting cavalry for infantry in the defense, commanders were able to mass infantry units for employment at more decisive sectors of the front. Applying the principle of economy of force, commanders accepted risk by spreading cavalry forces over large frontages in order to achieve the greatest combat power for decisive offensive, and occasionally defensive, action. Commanders counted on the characteristics of cavalry to provide them with time and space to maneuver if the enemy reacted in an unexpected manner. This method of employing cavalry was widely practiced by corps commanders throughout the European theater of Operations.

The employment of the 14th Cavalry Group by VIII Corps in December 1944 is a good example of cavalry being used to defend due to the lack of infantry. The 14th Cavalry consisted of the 18th and 32nd Cavalry Reconnaissance Squadrons. It was deployed in defensive positions astride an avenue of approach flowing directly from the German border into the Belgium Ardennes Forest.

The primary reason the cavalry group was employed in this defensive mission was the size of the VIII Corps front.<sup>11</sup> VIII Corps was deployed in what was considered a quiet sector of the First Army.

Generally it was considered one of the areas least likely for German offensive action due to the general low estimate of the German's military capability, and particularly, due to the rugged forest and mountainous terrain. For these reasons, VIII Corps was defending a 145 kilometer front with only four divisions, three times what doctrine prescribed for a force of this size. <sup>12</sup> Due to the size of the sector, the corps commander was forced to utilize his cavalry group in a defensive mission to ensure all avenues of approach were covered and to stay tied into V Corps on his left. <sup>13</sup> Thus on the eve of the infamous German counteroffensive, known as "The Battle of the Bulge," VIII Corps had deployed its elements from left to right: 14th Cavalry Group, 106th Infantry Division; 28th Infantry Division; 9th Armored Division (minus), and 4th Infantry Division (see figure 25). The corps held out the reserve combat command of the 9th Armored Division as the corps reserve.

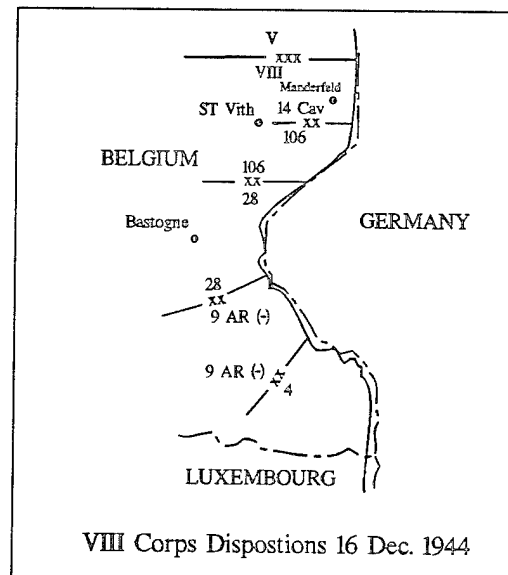

Figure 25. VIII Corps Dispositions, December 1944.

The 14th Cavalry was commanded by Colonel Mark Devine,<sup>14</sup> and had previously been involved in the siege of Brest. On the eve of the German Ardennes offensive it was deployed with one squadron, the 18th CRS, commanded by LTC Bill Damon, occupying defensive positions over a frontage approximately 7 miles.<sup>15</sup> Each of its two cavalry troops occupied a series of platoon strong points (the third troop, Troop B, was detached to the 106th Infantry Division). An attached tank destroyer company, Company A, 820th Tank Destroyer Battalion, was concentrated in the northern portion of the squadron sector. Squadron headquarters, as well as Troops E and F, were located in the town of Manderfeld.<sup>16</sup> The 18th CRS had been in position since October, most of that time attached to the veteran 2d Infantry Division. The group headquarters had assumed control of the area only on 11 December. The other squadron, the 32nd CRS, commanded by LTC Paul Ridge was located in the vicinity of Vielsalm, 20 miles to the rear of group headquarters, and was in the process of conducting refitting operations. Its mission was group reserve.<sup>17</sup>

The 18th CRS was deployed in platoon and troop strong points, each centered on a village. This was a typical tactical deployment which resulted from a variety of considerations: the stone house of the villages offered significant protection from both the weather and enemy fire; all major avenues of approach had to pass directly through the villages; and there were simply not enough personnel to maintain a continuous front between the 106th Division to the group's south, and V Corps' 99th Division to the north. The forest and trails between the

troops and platoons were covered by constant mounted and dismounted patrolling (see figure 26).

The attack of 18th Volksgrenadier Division (VGD)<sup>18</sup> of the German Fifth Panzer Army, and the 3 Parachute Division of the Sixth Panzer Army struck the 18th CRS on the morning of 16 December.<sup>19</sup> One regiment of the 18th VGD hit Troop A in the south, while the 3d Parachute Division hit Troop C and the Tank Destroyer Company.

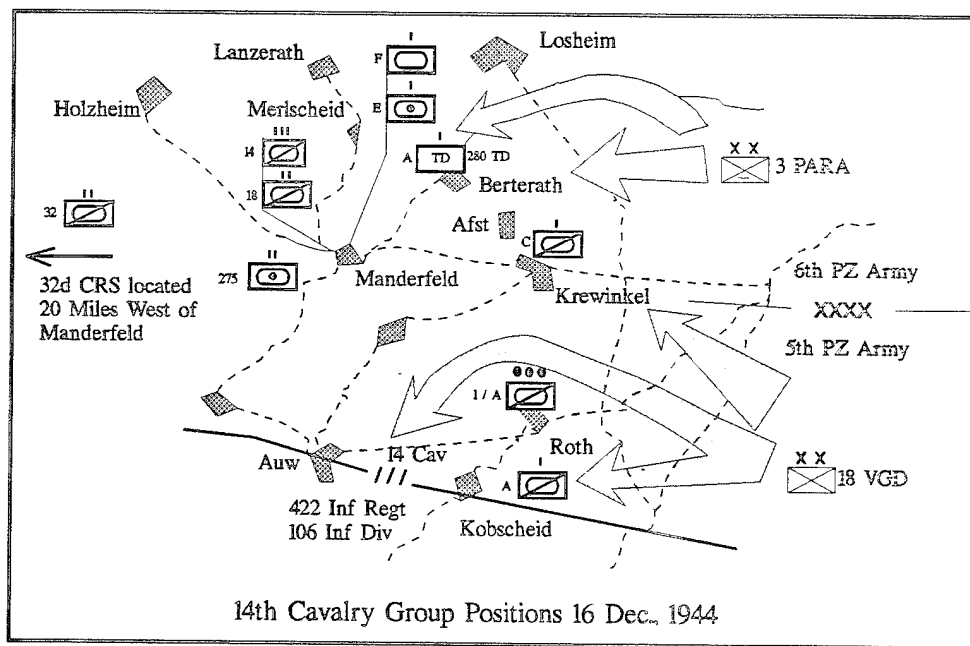

Figure 26. 14th Cavalry Group Positions, 16 December, 1944.

The tank destroyer platoons, equipped with 3 inch towed guns, were quickly overrun. Without infantry support the company was forced to destroy or abandoned its guns in place and withdrew to Manderfeld.<sup>20</sup> This in effect turned the flank of the squadron. Almost simultaneously, Troops A and C were surrounded and cut off. Throughout the day both

troops exacted a heavy toll on the Germans as they attempted to overrun the strong points with combined armor and infantry attacks. Troop C alone accounted for over 200 German dead during the day.<sup>21</sup> However, by the afternoon, after counterattacks by Troop F failed to break through to the units, the remnants of both cavalry troops were ordered to withdraw. Troop C was able to fight its way out by 1630, saving most of its personnel, and some of its equipment. The platoons of Troop A in Kobscheid infiltrated out during darkness after destroying their vehicles.<sup>22</sup> The rest of Troop A, in Roth, ran out of ammunition and surrendered about 1300 after German assault guns began firing directly into their positions from a range of 75 yards. Three Distinguished Service Crosses were awarded as a result of the intense fighting in the forward troop positions.<sup>23</sup>

As Troops A and C of the 18th CRS fought in their forward positions, the 32d CRS arrived in Manderfeld. Colonel Devine immediately ordered its elements to counterattack to the north and east to reestablish the group's original positions and relieve the forward elements of the 18th CRS.<sup>24</sup> These counterattacks failed, and as night fell on 16 December, the 32d CRS was fighting to maintain the group positions around Manderfeld.

On the 17 December the German offensive picked up momentum and swarmed around the 14th Group's flanks. Physical contact was lost with both the 106th and 99th Divisions. On this day the Germans employed their armor in strength and the Group's weapons proved totally ineffective against either the Tiger I or Panther tanks. The Germans cut off the northern most troop of the 32d CRS, surrounded it, and

forced it to surrender in the early morning darkness.<sup>25</sup> Throughout 17 December the group was on the move, constantly withdrawing to avoid being cut off as German units continually infiltrated around its positions. In the afternoon of the 17th, the 32d CRS attempted to establish a delaying position between the towns of Bord and Wallerode, while simultaneously attempting to counterattack and recapture Bord. The counterattack failed, and again the cavalry withdrew.<sup>26</sup>

On 18 December remnants of the group consolidated in defensive positions in the vicinity of Recht. The Group was put under the operational control of the 7th Armored Division which was preparing the defense of Saint Vith.<sup>27</sup> The group had lost 28% of its personnel and 35% of its equipment. Three of five cavalry troops had been destroyed. The 7th Armored Division consolidated all the remaining elements of the group under the operational control of the 18th CRS, and integrated that squadron into the defense of Saint Vith.<sup>28</sup>

The case of the 14th Cavalry Group illustrates how cavalry was used in the defense as a solution to the shortage of infantry. It also demonstrates vividly the risk a commander incurs when substituting thin cavalry positions for strong infantry positions to hold ground. The defense failed primarily due to the sheer size of the attacking German force. Significantly, the ability of the group to remain a coherent fighting force, and to retain some degree of combat power throughout the Ardennes campaign is directly attributable to its superior mobility and robust command and control capability. Infantry units of much larger size and combat power did not fare nearly as well in similar situations in the Ardennes.



A more common use of cavalry in the defense is for the purpose of economy of force. Unlike the case of the 14th Cavalry Group, when cavalry defended as an economy of force, its specific purpose was to permit the massing of forces somewhere else for decisive action. Usually it permitted mass for decisive offensive action. XX Corps of the Third Army used its 3d Cavalry Group in this manner during the offensive to capture the fortress city of Metz in October and November of 1944.

During the period September-November 1944, the Third Army stalled west of the Moselle River in front of the city of Metz. This halt in the rapid advance of the Third Army was caused by a number of factors, the most important of which was lack of fuel. At the beginning of September the allied command began experiencing severe logistics challenges, particularly in keeping the various spearheads of the armies fueled. The result of these shortages was the assignment of logistics priority to Field Marshal Bernard Montgomery's 21st Army Group. <sup>29</sup>

The impact of fuel priorities on General Patton's fast moving Third Army was immediate and drastic. It was particularly hardfelt by the Army's XX Corps under General Walton Walker. Walker's XX Corps, consisting of the 5th and 90th Infantry Divisions, the 7th Armored Division, and the 3d Cavalry Group, was moving rapidly toward Metz when the shortage of gasoline hit. Immediately the fast moving columns of the corps came to a halt. On 1 September the only unit moving was Colonel Drury's 3d Cavalry which was then leading the corps' continuing exploitation of the July break out of the Normandy beachhead. The 3d Cavalry was able to continue patrols toward the Corp's objective of Metz

for two more days with fuel captured from the enemy.<sup>30</sup> From 1 to 5 September, the XX Corps stood without sufficient fuel to continue operations. When, on 6 September, the fuel situation was restored sufficiently to continue operations, the battlefield situation had changed drastically. The five days of inactivity proved sufficient for the Germans to reorganize their defenses along the Moselle River. Subsequent attempts to quickly seize bridgeheads across the river failed.<sup>31</sup> The corps' remaining offensive capability was limited to closing its units to the west bank of the Moselle. On 25 September the corps was ordered to cease all offensive operations.<sup>32</sup> From the period of 25 September to 8 November the corps made limited advances and occupied defensive positions before the fortress city.

During this period the 3d Cavalry Group played a supporting but important role in the corps plan to keep continuous pressure on Metz. The corps front was approximately 40 miles long, extending from the city of Haute KONTZ in the north where it joined with the First Army, to the city of Pont a Mousson in the south where it tied into the XII Corps. During XX Corps operations to seize Metz, over half of this 40 miles front was defended solely by the 3d Cavalry Group.<sup>33</sup> This permitted the corps commander to rest divisions, and, more importantly, focus division operations around Metz.

The 3d Cavalry Group's defensive sector varied over the six week period 19 September to 8 November, from 20 to 25 miles of front. It extended from Haute KONTZ in the North, in contact with the 83d Infantry Division, to Uckange in the south, where it is tied into the 90th Infantry

Division.<sup>34</sup> The sector faced the Moselle, but included a German bridgehead on the western bank of the river at the town of Berg.<sup>35</sup>

For the duration of the operation along the Moselle River the group was designated Task Force Polk, after the new group commander, Lieutenant Colonel Jimmy Polk (Colonel Drury had been captured while on patrol on 5 September<sup>36</sup>). Initially the group was task organized with one cavalry squadron, the 43d CRS, a detachment (Troops E and F of the 6th CRS, and E and F of the 28th CRS) from the 6th Cavalry Group, the 135th Combat Engineer Battalion, and a battalion of French infantry.<sup>37</sup> Over the period of the mission the group was steadily reinforced with a variety of additional troops. In mid October it acquired the 3d CRS (back from a separate defensive mission in the south of the corps sector)<sup>38</sup>, as well as the 807th Tank Destroyer Battalion.<sup>39</sup> Over time it also received a growing number of French battalions, which were of only marginal use. Eventually, at its height, TF Polk number well over 5000 personnel, and included three battalions of a corps artillery group in support (see figure 21).

Task Force Polk's actions along the Moselle typified cavalry defensive actions. The units were spread thinly in platoon and troop strong points oriented on potential enemy crossing sites or bridgeheads. The gaps between strong points were vigorously patrolled by the cavalry reconnaissance troops dismounted, and by the tank troops mounted. Patrolling was also extended regularly across the river to the east bank. The armored troops, which in numbers equaled a light tank battalion, served as squadron and group mobile reserve forces, prepared to counterattack as required. The assault gun troops, also equaling a

battalion strength in numbers, were consolidated and tied into the supporting field artillery battalion's fire control nets.

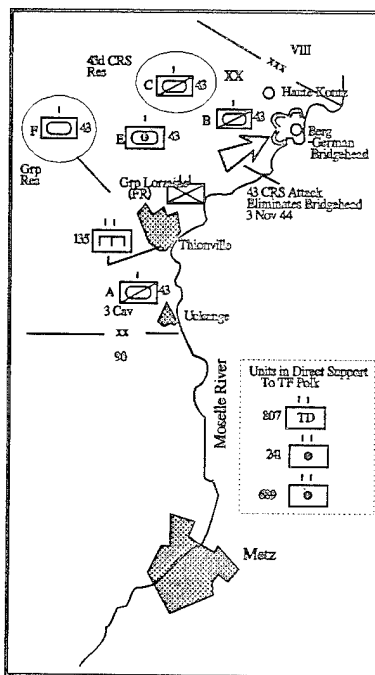

Figure 27. 3d Cavalry Group Disposition, October, 1944.

In addition, on 3 November the group mounted a deliberate dismounted attack by Troops A and B, 43d CRS, supported by tanks of Troop F, to seize the town of Berg. This attack eliminated the German bridgehead at Berg after a two day fight.<sup>40</sup> Of key importance, XX Corps deployed a deception team which portrayed the radio signature of a division behind the Group throughout the operation.<sup>41</sup>

Ultimately the defense of Task Force Polk was never seriously tested. Its aggressive actions, combined with the radio deception team's efforts, convinced the Germans that the area was defended by an entire armor division.<sup>42</sup> On November 8 the 90th Infantry Division,

wearing 3d Cavalry unit patches, attacked across the Moselle through the Group's positions and began the final stage of the siege of Metz, ending the Group's defensive mission.<sup>43</sup>

The 3d Cavalry's defense of the Moselle was typical of the type, size, purpose, and duration of cavalry defensive missions. The 3d Cavalry would perform a similar mission again in January 1945, defending 20 miles of corps front as the XX Corps sought to breach the Seigfred Line . This type mission was also executed by other groups throughout the theater. Further south, in the XII Corps sector, the 2d Cavalry Group defended a 20 mile stretch of the Moselle with two cavalry squadrons for three months from December 1944 to February 1945.<sup>44</sup> At the extreme northern tip of the 12th Army Group, the 113th Cavalry Group defended 10 miles on the left flank of First Army for five weeks in September and October 1944.<sup>45</sup> Not only were these missions common, but they were critical to permit corps and army commanders to control ground at the operational level and still mass combat power at the decisive point for offensive operations. The economy of force mission was not very glamorous, but it was dangerous and required great tactical skill. Ultimately, it was one of the keys to operational success.

Cavalry doctrine as outlined in both FM 2-15, and FM 100-5, permitted a limited defensive role for horse cavalry. It did not, however, envision mechanized cavalry defending, nor did it provide for a defensive mission in the mechanized cavalry organization. Yet these missions were conducted generally successfully through task organizing with other arms and the skillful emphasis of the strengths of mechanized cavalry: combined arms operations; dismounted patrolling; mobility;

command and control; and small unit leadership. However, as the case of the 14th Cavalry demonstrates, no amount of skillful employment, or leadership, could substitute for unit mass, or could make up for the organization's woefully inadequate anti-armor capability. Thus, employing cavalry in defense always entailed a calculated risk on the part of the commander, and was willingly done only as means of massing combat power elsewhere.

#### Security

After defense, the second most common mission performed by mechanized cavalry groups was security. Security was defined by FM 100-5, 1944, as "...all measures taken by a command to protect itself against annoyance, surprise, and observation." The manual also addressed cavalry's role in security as reconnaissance, which it stated "is an essential part of security,"<sup>46</sup> and providing early warning.<sup>47</sup> It did not foresee mechanized cavalry providing protection from enemy forces, in particular, enemy mechanized forces. Protection from enemy mechanized forces was the doctrinal role of mobile tank destroyer units.<sup>48</sup> In the field, however, corps commanders conducted advance and flank security operations with mechanized cavalry.

A clear demonstration of cavalry's employment in this role was the utilization of the 2d Cavalry Group, commanded by Colonel James Reed, during the XII Corps encirclement of Nancy in September 1944.

XII Corps, part of Third Army, paused briefly due lack of fuel prior to its attacks to capture the city of Nancy in early September 1944. On 5 September the corps launched a planned three division

attack to secure the city. This initial attack failed when the 80th Infantry Division failed to secure a bridgehead over the Moselle River.<sup>49</sup> On 11 September the corps tried again and this time was successful in establishing two bridgeheads across the river: one north of Nancy secured by the 80th Division; and one south of Nancy established by the 35th Infantry Division. The corps then crossed Combat Commands A and B of the 4th Armored Division to support the northern and southern bridgeheads respectively.<sup>50</sup>



Figure 28. M8 Assault Gun in Action. Source: US Army Photo reproduced in Steven Zaloga, Stuart, U.S. Light Tanks in Action (Carrollton, TX: Squadron/Signal Publications, Inc., 1979), 39.

Once on the far side of the river the 4th Armored Division conducted a wide double envelopment of Nancy, leaving the securing of the city to the infantry. The 2d Cavalry group was deployed with its

two squadrons, the 2d CRS and the 42d CRS, echeloned to the right of Combat Command B, providing flank security to the division and the corps southern flank.<sup>51</sup>

Once established on the far side of the Moselle, XII Corps paused for three days, providing the Germans the opportunity to gather forces for a counterattack.<sup>52</sup> The mission of counterattacking fell to General Hasso Von Manteuffel's Fifth Panzer Army. He received two newly deployed panzer brigades, the 111th and 112th, to execute the attack. His plan was to attack from south to north through Luneville. The intent was to attack towards Nancy, thus cutting off the XII Corps penetration, and the 4th Armored Division, at its base.<sup>53</sup>

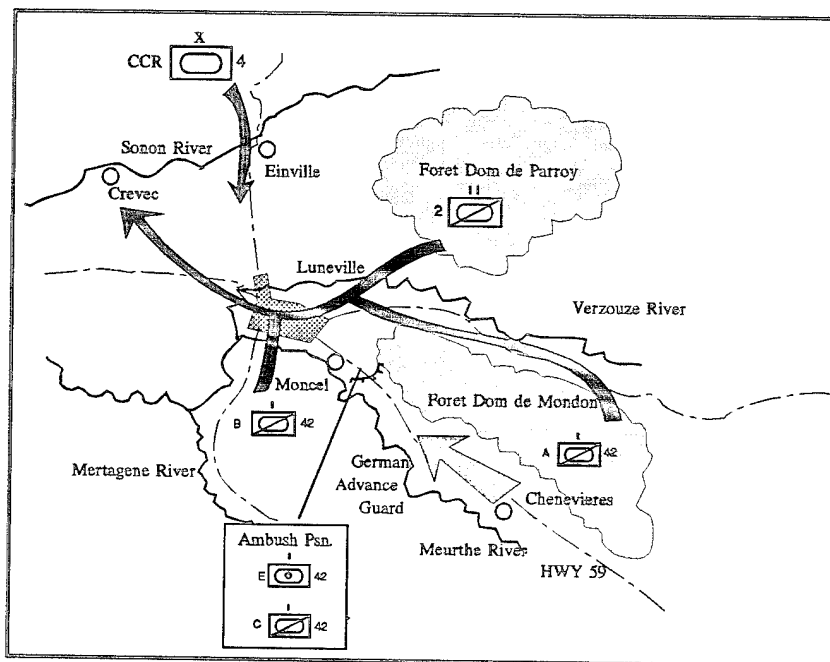

Figure 29. 2d Cavalry Group Delay at Luneville.



On 19 September the lead elements of the 111th Panzer Brigade began their attack. They were immediately observed by the forward outposts of the 2d Cavalry's 42d CRS, manned by Troop A.<sup>54</sup> Colonel Charles H. Reed, the group commander, and Major James H. Pitman, commander of the 42d CRS, moved to intercept the lead German elements, establishing an armor ambush using the 42d CRS's Troop C and Troop E's assault guns<sup>55</sup> (see figure 29).

They sprang the ambush effectively and surprised the enemy advance guard of Panther tanks and their accompanying infantry. However, the 75-mm guns of Troop E were unable to penetrate the armor of the German tanks and managed only one mobility kill for the loss of three assault guns.<sup>56</sup> Troop C was more effective fighting dismounted against the German infantry. The fires of Troop C forced the German infantry to dismount and then repelled the following dismounted attack. However, the cavalry had no effect on the German tanks which systematically began destroying cavalry vehicles.<sup>57</sup> Troop C suffered losses of one armored car and two jeeps, and Colonel Reed was severely wounded and Major Pitman killed. The German tanks, after losing their infantry support, withdrew and by-passed the cavalry position moving on a different route toward Luneville.<sup>58</sup> The cavalry withdrew, using the forest for cover, through Luneville to Crevec.

The actions of Troops C and E were sufficient to provide time for the Group to pull the other elements of the 42d CRS and the 2d CRS across the Meurthe River into Luneville. More important, the delay caused by these two troops, combined with delay caused by the initial actions of Troop A's outposts, was sufficient to allow the reserve

combat command, CCR, of the 4th Armored Division, and other forces to move to Luneville and blunt the German attack.<sup>59</sup> Another effect of the 2d Group delaying action was the deflection of the German counterattacks to the north and east toward CCA and CCB of the 4th Armored Division. This led to the decisive defeat of the German armor in the tank battles around Arracourt.

The actions of the 2d Cavalry clearly indicate the major impact that even small numbers of mobile units can have on a battle. They demonstrated that the role of security forces is not to win battles or retain terrain, but rather to provide protection and buy time. The battles around Luneville demonstrate, however, how ill-equipped mechanized cavalry was to repel armor attacks. The success of the Luneville action came despite ineffective anti-tank weapons. It was a result of good operational and tactical positioning, and the leadership of Colonel Reed and Major Pitman. Colonel Reed was subsequently awarded the Distinguished Service Cross.<sup>60</sup>

The Luneville action of the 2d Group is typical of the use of cavalry for flank security. In addition to flank security missions, cavalry was also used occasionally as an advance security force and as a rear security force. These missions, however, were more often assigned to squadrons or troops, rather than entire groups. For corps cavalry groups, advance guard actions were not as common as flank security missions because in the advance guard role contact with significant enemy forces was expected. The exception to this is the advance guard in the pursuit, when enemy combat forces were disrupted and speed was essential. Armored divisional cavalry, because of its close support

relationship with the armor and armored infantry units of the division, often were used as troop size advance guards for the division's combat commands.

The 4th Armored Division organized its cavalry as an advance guard in its attack to break through to Bastogne beginning 22 December 1944. Combat Command A, attacking on the eastern axis, was led by a team organized around Troop A, 25th CRS. Combat Command B, attacking on the western axis was led by Troop B, 25th CRS. The remainder of the 25th CRS, Troops C, D, E and F, initially provided western flank security for the division. Ultimately the main effort of the division was shifted to CCR. When this occurred Troop C was attached to that command to provide flank security (see figure 30).<sup>61</sup> CCR broke through to Bastogne on 26 December, four days after the division attack began.<sup>62</sup> This disposition of cavalry in support of an armored division attack, with a troop supporting each of the combat commands, was typical. It was anticipated by the additional troop authorization to the armored division squadron under the 1943 table of organization.

Actions in the European theater demonstrated that cavalry flank security was expected to provide protection through delay and defensive action. When acting as part of the advance guard, cavalry was expected to attack and destroy enemy outposts and define the main centers of enemy resistance. The combat requirements of mechanized cavalry security went well beyond the early warning which was the only requirement in published doctrine. Security in combat required fighting, a requirement not envisioned by the official doctrine or tables of organization.

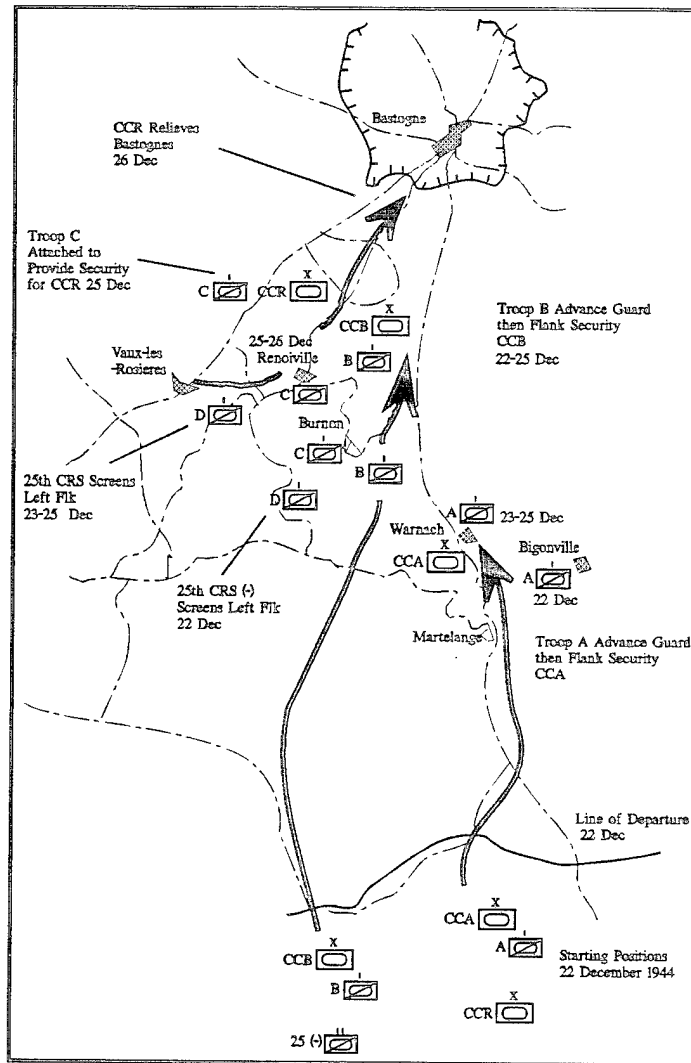

Figure 30. 25th CRS Leading Attack to Bastogne.

Offensive Missions.

Cavalry doctrine, as expressed in FM 100-5, and FM 2-15, advocated using cavalry for limited offensive operations to secure specific significant objectives. Doctrine also advocated using cavalry to lead the pursuit of an enemy whose lines had been penetrated. These missions, as discussed previously, were envisioned for horse cavalry. Cavalry doctrine permitted mechanized cavalry to attack as part of a

pursuit or in support of reconnaissance missions.<sup>63</sup> As with defensive missions, the circumstances of the European campaign forced commanders to employ mechanized cavalry in the traditional role of horse cavalry. Thus, mechanized cavalry was used offensively to lead pursuits, and to capture key objectives such as bridges. They were also used when required to conduct deliberate offensive operations when infantry or armor were not available.

During the European campaign the US armies were able to disrupt the German defenses to the point of executing pursuit operations on two occasions. The first occasion was following the breakout of the Normandy beachhead and the virtual destruction of the German Seventh Army in Falaise. The second occasion was following the breaching of the Rhine River and the destruction of the German Army Group in the Ruhr. On both of these occasions cavalry groups and squadrons were in the vanguard of vigorous pursuits.

There are many examples of cavalry leading in the pursuit of the summer of 1944. Already alluded to was the 3d Cavalry's rapid advance at the head of XX Corps from Avaranches to the banks of the Moselle in August 1944. Another noteworthy dash was that made by troops of the 102d Cavalry Group into the heart of Paris on 1 September 1944.<sup>64</sup> The 4th Cavalry led VII Corps to the Seigfried line in the Ardennes by the middle of September.<sup>65</sup>

In pursuit, cavalry attacked mounted, using speed and surprise to compensate for the lack of armor protection and anti-tank capability. The objective during the pursuit was to maintain the tempo of operations to prevent the enemy from organizing an effective defense. This

required units to quickly breach natural obstacles such as rivers, and often to attack despite being outnumbered. The actions of the 82d Reconnaissance Battalion, 2d Armored Division, in August 1944, typify actions of cavalry in pursuit.

At the end of August 1944, the 2d Armored Division was advancing rapidly as part of the XIX Corps drive from the Seine River to the Somme River. The 82d Armored Reconnaissance Battalion, under the command of Lieutenant Colonel Wheeler Merriam, led the division's CCA. The battalion was initially tasked with seizing crossing sights over the Somme River.<sup>66</sup>

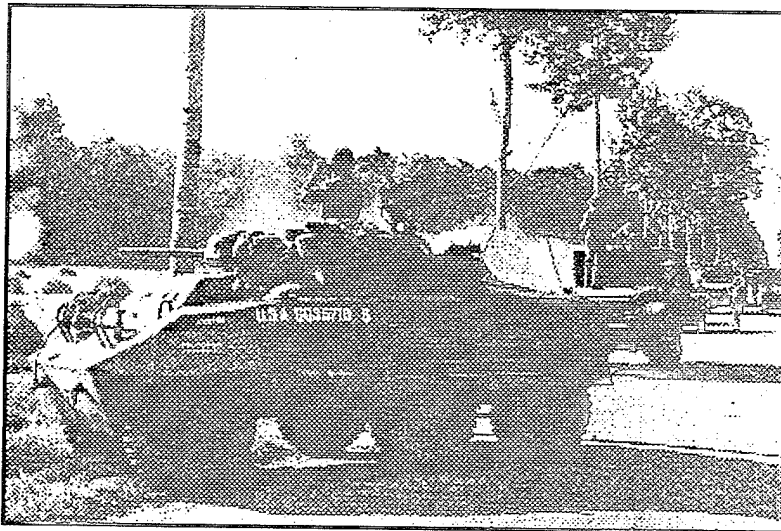

Figure 31. Cavalry advancing during the summer of 1944. Source: US Army, Photo reproduced in Kent Roberts Greenfield, editor, US Army in World War II, Pictorial Record: The War Against Germany: Europe and Adjacent Areas (Washington DC.: Center for Military History, 1951), 157.

The division commander, Major General Edward H. Brooks urged the 82d ARB to move rapidly before German resistance could be organized.

The second platoon of Company C, 82d ARB, raced into the city of Peronne at thirty miles an hour and found the bridge still standing. The platoon's armored cars attacked the bridge guards and the platoon leader dismounted to cut the demolition charge wires before the bridge could be blown. German automatic cannons attempted to take the platoon under fire, but were silenced by the platoon's mortars. The first platoon then reinforced second platoon, and together they defended the position until relieved by the division main body.<sup>67</sup>

Moving along a different route that night, the battalion's Company D was overtaken by a retreating German column. The company maintenance section moving at the tail of the column informed the commander that there was enemy to his rear. He ordered his tanks to pull over. When the German column came abreast of the American tanks the company opened fire, devastating the German unit. The company then resumed its march and seized a bridge at Aubencheul au Bac.<sup>68</sup>



Figure 32. 82d ARB Leads Allies into Belgium. Source: US Army photo reproduced in Houston, 267.

The 2d Armored Division's pursuit, with the 82d Reconnaissance Battalion leading, continued into the beginning of September. On 1 September 1944, Company A of the 82d ARB was the first American unit into Belgium. That day the battalion captured 800 prisoners, destroyed three 75-mm assault guns, eight other vehicles, and assorted horse drawn carts.<sup>69</sup> At this point in the operation the division was halted due to fuel shortages.

The division resumed the attack on 5 September and good progress was made as far as the Albert Canal. On 6 September Company C of the Battalion captured almost 300 prisoners. However, the halt in the pursuit caused by the fuel shortage permitted the Germans to destroy all the bridges over the canal. On 11 September the division crossed the canal. The 82d ARB was the lead mounted unit across and was tasked with clearing the zone for the division. The battalion attacked and quickly seized its initial objective, but a German counterattack temporarily drove the Americans back. The battalion regrouped and continued the attack. The battalion commander and the tank company were in the lead when they ran into a German anti-armor ambush. In less than five minutes the lead platoon of D Company was wiped out. The battalion commander's armored car was also destroyed.<sup>70</sup> This action signaled the end of the pursuit and the return of hard fighting. At this point the battalion was replaced by armored and armored infantry units.

Cavalry was the ideal corps or armored division element to lead a pursuit. The light armor of the cavalry was a major advantage when pursuing the enemy because speed, not firepower or protection, were essential to preventing the enemy from reorganizing his defenses.



Cavalry units were faster than armor or armored infantry in terms of road speed, with the all wheel reconnaissance platoon capable of maintaining speeds over 50 miles per hour. The mechanized cavalry was also more maneuverable than other arms due to the lower ground weight of its vehicles which allowed it to cross small bridges as well as soft ground. The cavalry's enhanced command and control capability allowed it to move dispersed searching out clear areas, intact bridges, fords, and by-passing areas of resistance. Finally, when the enemy was encountered, cavalry troops were capable of hitting fast and hard with a coherent combined arms team of light tanks, armored cars, assault guns and mortars. This small synchronized combined arms team provided sufficient combat power to break up any hastily organized resistance.

In addition to leading the great pursuits of the European campaign, cavalry was also employed to execute deliberate attacks. Against an enemy who was prepared and possessed artillery or armor support, cavalry's combined arms mounted attacks were not effective. This was primarily due to the lack of armored protection and anti-tank capability of the light tanks and armored cars. Therefore, when assigned a deliberate attack, cavalry more often than not attacked dismounted.

The 6th Cavalry Group demonstrated how cavalry used its combined arms characteristics to execute a deliberate attack during the counterattack following the Germans Ardennes offensive. In December 1944, the 6th Cavalry Group was operating in a defensive economy of force role along the Saar River in the southern part of the XX Corps sector. As part of Patton's reaction to the Germans Ardennes attack,

the group was moved over 100 kilometers north and entered the line counterattacking toward Bastogne on the left of the 4th Armored Division on 25 December 1944. Under III Corps control the group fought a series of minor actions and then went into corps reserve.<sup>71</sup>

On 1 January the group was again committed to offensive action, moving into the III Corps line to fill gaps within the 35th Infantry Division's sector. At this point the group's 28th CRS and 6th CRS were separated by the positions of one of the 35th's infantry regiments. Still under corps control the group was ordered to execute a deliberate attack to seize the town of Watrange on 11 January 1945. To accomplish this the group commander, Colonel Pickett, task organized the group, creating Task Force Burke consisting of the group's two tank troops, Troop E of the 28th CRS, and a platoon of self propelled tank destroyers.<sup>72</sup>



Figure 33. M8 Armored Car in Winter Camouflage. Source: US Army Photo reproduced in Kent Roberts Greenfield, editor, US Army in World War II, Pictorial Record: The War Against Germany: Europe and Adjacent Areas, 285.

The attack began on the morning of the 11th of January with Troops C and B of the 28th CRS attacking the village on foot through the snow. Troop A, 28th CRS was the squadron reserve, Task Force Burke (mounted) supported the attack by fire and then moved into the village mounted as the dismounted element gained the town. By 1100 the town was in the hands of the cavalry. The group then committed the 6th CRS to continue the attack mounted. The 6th CRS attacked through Watrange and continued on to capture the town of Tarchamps as darkness fell. The attack resulted in over 500 enemy killed and over 300 prisoners.<sup>73</sup> It was one of the first successful attacks against the southern shoulder of the Bulge since the relief of Bastogne and it was the precursor of a month of similar battles as the Allied forces slowly reduced the Bulge.

Mechanized cavalry executing a deliberate attack against a prepared enemy was not remotely envisioned by any of the doctrine relevant to cavalry. The 6th Cavalry example is similar to the defensive mission of the 14th Cavalry in that both units were used by their respective corps to conduct deliberate combat missions due to a shortage of armor or infantry. The 6th Cavalry attack was successful due to skillful employment of all arms, emphasizing the capabilities of the cavalry squadron. It was also successful because of the absence of German armor or anti-armor capability in any strength. The battle demonstrated the capability of a combined arms force to rapidly exploit success. The attack of the 6th Cavalry was, however, a non doctrinal employment of mechanized cavalry.

### Reconnaissance

Reconnaissance, as a singular mission was a rare occurrence. It most often was conducted in conjunction with the execution of other missions. When it was required, however, cavalry squadrons and groups were very adept at it for obvious reasons. A unique situation requiring pure reconnaissance occurred early in the European campaign as the German forces defending the Cotentin Peninsula broke contact and occupied the city of Cherbourg in late July 1944. The 24th CRS, part of the 4th Cavalry Group under VII Corps, was detached from the group, and attached to the 4th Infantry division for the purpose of securing the corps right flank.<sup>74</sup>

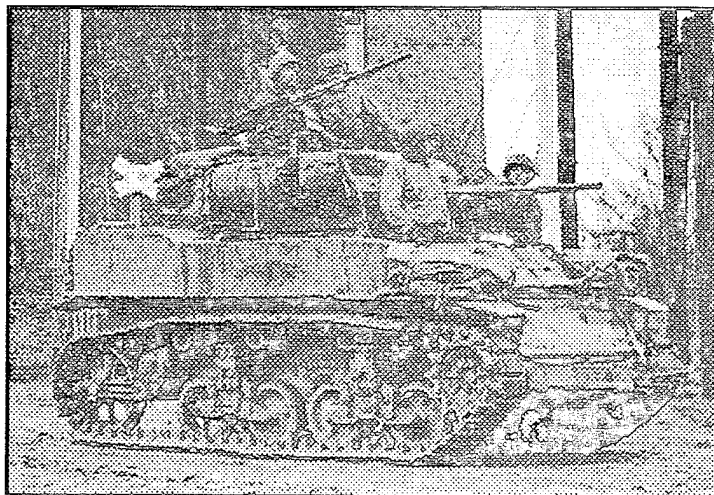

Figure 34. M5A1 of the 4th Cavalry Group. Source: US Army Photo reproduced in Zaloga, 37.

The 24th CRS's initial mission was to screen the right flank of 4th Infantry division and, for this purpose, it was further attached to the 22d Infantry Regiment.<sup>75</sup> On 19 June the Squadron was ordered to

secure a Bridgehead over the Sinope River. The squadron accomplished this using Troop C, but a German counter-attack forced the troop to give up its bridgehead. Within hours the squadron attacked again, this time using the tanks of Troop F covered by a smoke screen fired by Troop E. The attack was successful in ejecting the Germans and securing the bridgehead.<sup>76</sup>

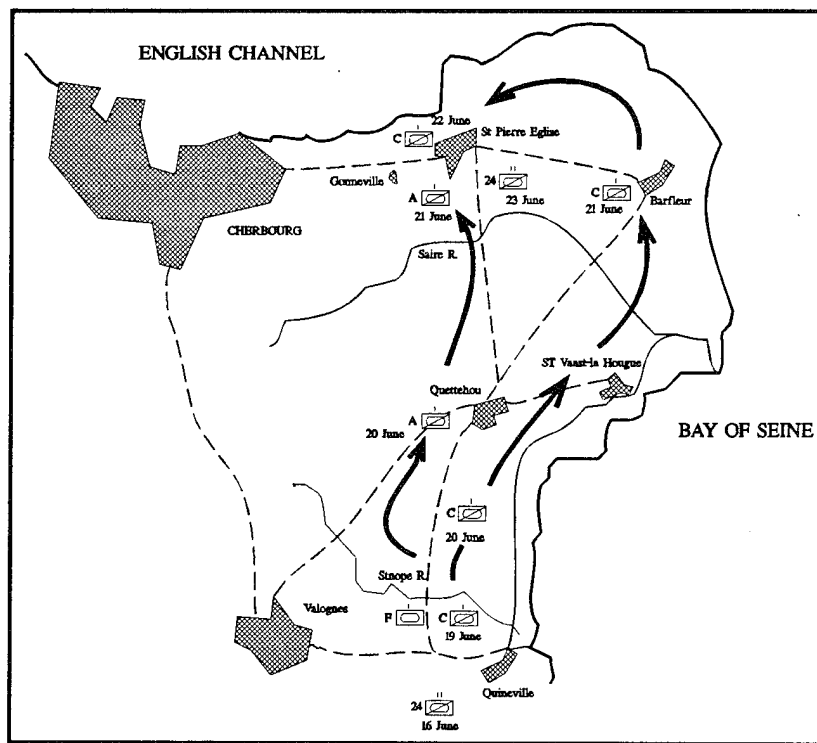

Figure 35. 24th CRS Reconnaissance of the Cotentin Peninsula.

At this point in the campaign for the Cotentin, the Germans attempted to break contact and withdraw into the defenses of the city of Cherbourg. As the enemy withdrew the 24th CRS, under 4th Infantry Division control, conducted a rapid reconnaissance to reestablish

contact with the enemy and determine his dispositions. For the three days of June 20 - 23, the squadron reconnoitered the eastern coast of the peninsula, attempting to determine the centers of German resistance (see figure 25). On 20 June Troops C and A reconnoitered the roads to the town of Quettehou, attempting to regain contact with the enemy. The troops found the roads extensively mined and cratered, removed demolitions from several bridges, but were unable to locate the enemy main body. On 21 June the reconnaissance continued with Troop A moving to St. Pierre Eglise and Troop C to Barfleur. Again, although a few prisoners were taken, resistance was slight. On 22 June Troop A began reconnoitering west from St. Pierre Eglise toward Cherbourg, and was stopped by heavy resistance in the vicinity of Gonneville, about 3 miles east of Cherbourg. Troop C continued the reconnaissance along the coast from Barfleur to St. Pierre Eglise, coming on line with Troop A. On 23 June the squadron tested the enemy defenses by executing limited attacks against the town of Gonneville with Troop's E and F. The squadron also relieved Troop B of its mission on the Sinope River and brought it forward to enter the line between Troops A and C on 24 June.<sup>77</sup> At this point, on 29 June, the squadron's mission reverted to security of the division and corps right flank by defending.

This mission demonstrates that the lessons learned in North Africa regarding combat and reconnaissance still apply. Even with the enemy disengaging and withdrawing, the squadron was required to fight for information. The purely combat elements of the squadron, Troops E and F, were critical to the mission's success. Likewise, the reconnaissance troops also had to fight to conduct reconnaissance and

took over 50 prisoners of war during the period.<sup>78</sup> The terrain and enemy was such that by-passing was usually impractical. Finally, the mission demonstrated the truism that reconnaissance is rarely pure, but at different times incorporates aspects of defense, offense, and security. The mission required an attack to secure the bridge heads over the river Sinope to start the mission. It also ended in attacks to determine the nature of the defense in the vicinity of Gonnevillle, and then defense to continue to secure the right flank of the 4th Infantry Division.

#### Special Missions

Cavalry Doctrine expressed in FM 100-5, and FM 2-15 indicated that cavalry could be used for a variety of specialized missions. FM 2-15 indicated that examples of special missions included liaison, filling gaps between units, and providing security for command posts.<sup>79</sup> Cavalry did all of these missions and more.

One of the more unique special missions performed by cavalry was the role the 6th Cavalry Group played in the Third Army from August to December 1944. During this time period the 6th Cavalry Group, and in particular the 6th CRS, was officially designated as the Army Information Service for Third Army.<sup>80</sup> The purpose of this mission was to ensure that the Army commander, General Patton, and his staff, as well as other senior personnel, were constantly kept apprised of what was happening at the tactical level in the army. The intent was to ensure that the army commander had rapid and direct communication with the tactical commanders at division level. General Patton felt that the

army was well served employing a cavalry group in this manner due to the importance of reliable communications when conducting army level maneuver warfare.

The 6th Cavalry group was uniquely qualified to perform this mission. The 6th Cavalry, unlike most regular army units, had never been cadred to form new units as the Army expanded. It was also one of the two original horse-mechanized regiments. These factors combined to create an unequalled professionalism within a unit made up largely of prewar regulars. A reflection of this professionalism was the skill of the group's radio operators. The group commander indicated that his personal radio operator could transmit long distance key messages in the dark, in a jeep, moving cross country, faster and with less errors than the signal men in the Third Army's headquarters signal battalion.<sup>81</sup> General Patton agreed with him.

To accomplish this mission required the group to dedicate the entire 6th CRS. Each Third Army corps headquarters had a 6th CRS troop headquarters with it and a cavalry platoon shadowed each division headquarters. All of these units communicated directly with Group Headquarters which was located with Army Headquarters. The tank and assault gun troops were detached for most of this operation. In this manner the Army commander maintained virtually real-time situation awareness, and was free of the cumbersome and slow chain of command.

Another important special mission of cavalry was rear area security. The 28th CRS, 6th Cavalry Group was used as an army rear security force (while the 6th CRS ran the information service).<sup>82</sup> Many other cavalry units temporarily provided rear area security forces



during the war. This mission was assigned to the 125th CRS of the 113th Cavalry Group with on four hours notice during the Battle of the Bulge.<sup>83</sup> In March 1945 the 101st Cavalry Group was assigned the mission of conducting mopping up operations in the rear area of XXI Corps.<sup>84</sup> Another aspect of rear area security conducted by cavalry was convoy escort. The relief supply convoy to the cut off infantry battalion on Hill 315 at Mortain arrived escorted by tanks of the 4th Cavalry Group.<sup>85</sup> One of the 7th Armored Division's 87th CRS's primarily tasks in the month of August 1944 was securing the logistics line behind XX Corps.<sup>86</sup> Mobility, command and control, and firepower were the requirements for these missions and thus they were ideally suited to the cavalry.

A variety of other special combat missions were performed by cavalry. Raids, both mounted and dismounted were frequently conducted at the troop and platoon level. Cavalry troops were used to conduct amphibious landings. Finally, cavalry squadrons and groups executed assault river crossings on numerous occasions.

As the war came to a close, a final special mission was organizing and controlling the hundreds of thousands of displaced persons who required food, shelter, and policing as they migrated in all directions through US Army areas of operations. The mobility, fire power, command and control, and psychological impact of the light armored vehicles of cavalry gave it capabilities in the area of civil military operations unique among all US Army forces.

The special missions assigned to cavalry were not all doctrinal. Some of the missions, those associated with mobility, like liaison and

rear security, were anticipated by horse cavalry doctrine. Many of the missions, such as amphibious landings, convoy escort, and civilian population control, were a result of the recognized flexibility of the cavalry organizations at all levels from group to platoon.

### Lessons Learned

The performance of mechanized cavalry in the European theater of operations during World War II had a profound impact on most of the senior level commanders who served in the theater. The theater made a concerted effort to gather information, opinions, and facts regarding the experience of mechanized cavalry. The Army's evaluation of the performance of mechanized cavalry were captured in the General Board Report Study Number 49, "Mechanized Cavalry Units," published in November 1945. This report captured many of the most important insights regarding mechanized cavalry, and was reviewed by all the key fighting headquarters and many of the key leaders at corps and army level.

The most fundamental lessons learned from the mechanized cavalry operations in Europe are in regards to doctrine. Cavalry units confirmed the tactical lessons learned in North Africa regarding combat and reconnaissance, and the importance of other missions. They also demonstrated at the operational level the role cavalry played in corps and Army maneuver. These lessons demonstrated the inadequacy of the written doctrine which existed for mechanized cavalry during the war.

Cavalry units had not been ashore at Normandy 24 hours before it was demonstrated to elements of the 24th CRS, 4th Cavalry Group, that

combat was required to conduct effective reconnaissance. The tactical lessons regarding the relationship of stealth and combat to reconnaissance learned in North Africa were confirmed in the actions of the 24th CRS on the Cotentin peninsula. Stealth was still felt to be valid in particular situations, particularly when time was available for careful dismounted patrolling. However, when time was short, or when the enemy was prepared, combat was required to gather combat information.

An additional doctrinal lesson learned regarding cavalry relates to the tactical missions of mechanized cavalry. Europe proved that when employed skillfully, and in circumstances that accounted for their characteristics, mechanized cavalry was more than capable of fulfilling all of the tactical missions of horse cavalry, and was not limited to just reconnaissance. In particular, mechanized cavalry proved very effective in the defense. It also demonstrated that it could provide flank and forward security, and execute attacks. Cavalry proved to be particularly well suited to fast paced, unstructured offensive operations required by pursuit. A variety of special missions, including control of civil populations and convoy escort, were also effectively executed. In its tactical capability, flexibility, and success, cavalry far exceeded the limited doctrinal view envisioned for it by the doctrine writers at Fort Riley, Kansas.

An aspect of cavalry employment not recognized by doctrine was difference in employment of corps cavalry and divisional cavalry. Although both types of cavalry executed the total range of traditional cavalry missions, the frequency of mission types varied considerably

between the corps cavalry squadrons and the armored division cavalry squadrons. The corps cavalry was employed in offensive and defensive missions 43% of the time, while these missions were executed by division cavalry units 15% of the time. Division cavalry performed more reconnaissance missions, 13% of the total missions versus 3% in corps cavalry.<sup>87</sup>

Division cavalry squadrons were also more prone to have troops detached than corps cavalry. Routine armored division offensive operations, as demonstrated by the 4th Armored division attack to Bastogne, called for at least one cavalry troop to lead each combat command. This often left the squadron with insufficient combat power to execute its own mission effectively. Consequently, this often resulted in the squadron being placed in reserve while its troops led the various spearheads of the division under combat command control. The organization of the divisional squadron anticipated this to some degree by the addition of Troop D to the divisional squadron, but this solution was often not adequate. The impact was that the divisional squadrons, as a unit, were not the key players in division operations that the corps groups often were at their level.

A very important, but somewhat subtle lesson was the role of the mechanized cavalry group as an operational tool for economy of force. The US Army's large unit (corps and army) doctrine was largely dominated by the World War I experience and emphasized the infantry artillery team. Army doctrine maintained that on the modern battlefield armor would play the role previously performed by cavalry. Armor would be committed in a supporting role for infantry, and then employed in large

units once a penetration occurred. Unfortunately, this is not what happened on the battlefield.

In World War II, armor was an integral part of the combined arms combat team in close conjunction with infantry and artillery. It did not play a supporting role. Therefore, the traditional supporting roles of cavalry fell to the mechanized cavalry to execute. One of the most critical roles was that of economy of force. The skillful use of mechanized cavalry, particularly in the defense, allowed corps and army commanders to mass their combined arms combat power for decisive battle. At one point in the late fall of 1944, over 60 miles of the Third Army front was covered by the army's three cavalry groups. It was one of the reasons that Patton's Third Army was able to continue offensive operations even after most of the American combat power had been shifted north to General Courtney Hodges First Army. Economy of force by cavalry also had the additional benefit of allowing rest, maintenance, and training periods for divisional units.

Economy of force by cavalry was probably the greatest contribution that cavalry made to the US Army's success. It directly effected the outcome of some of the decisive battles such as the capture of Nancy, the siege of Metz, and many aspects of the Ardennes battles. The use of cavalry in this role, and even the term itself is absent from all of the relevant doctrine. Some consideration of economy of force may be implied in some of the tactical missions stated for horse cavalry, but FM 100-5, and FM 100-17 make no use of the term, or provide any hint of the use of cavalry to accomplish the purpose of massing combat power.

FM 2-15 stated that the mission of Cavalry was combat and the European campaign demonstrated vividly that this was true. The combat record of cavalry was exemplary. The magnitude of the achievements of mechanized cavalry are especially noteworthy when considering that most of the missions assigned were not addressed in doctrine. This doctrinal void influenced organization and equipment, both of which derive from doctrine. Shortcomings in these areas were demonstrated in combat.

Deriving directly from the doctrinal lessons learned were lessons learned regarding organization. The cavalry group was a successful but flawed combat organization. It was a combat organization that had no useful written doctrine either for its operational employment or its tactical execution of missions. The cavalry group was the only one of the corps and army level groups to be employed in a direct combat role. All other groups, such as artillery, air defense, and engineer for example, were employed in combat support, or indirect combat roles. The group concept was adequate to these tasks but not adequate for the sustained direct combat role which was experienced by the cavalry group.

The size of the group limited its tactical flexibility and staying power. The group, typically with only two attached squadrons, was unable to execute the traditional combat doctrine of employing two thirds of a unit's combat power (two squadrons) in action, and maintaining a one-third reserve (one squadron). This typically forced groups to keep an exceptionally large reserve of one entire squadron, or an exceptionally small reserve of one troop. The tactically limiting effects of this organization were demonstrated in the Ardennes where the

14th Cavalry had the entire 38th CRS in reserve, and in the Moselle valley where the 3d Cavalry had both of its squadrons in the line for extended periods with no significant reserve. In either case it was inefficient, tactically limiting, and placed a significant stress on the elements in combat. To be a balanced combat maneuver force the group required a three squadron organization.

In addition to lacking an adequate number of squadrons, the group did not have any organic combat support or service support assets with which to support the squadrons or weight a main effort. These assets, when provided, were attached from corps or army level units. In practice this frequently resulted in the case of the cavalry not having attachments, as demonstrated by the 2d Cavalry at Luneville. It also often resulted in attachments that were unfamiliar, untested, and sometimes unsuited to combined operations with cavalry. The attachment of towed tank destroyers to the 14th Cavalry in the Ardennes is a typical example. Cavalry groups would have been much more effective if they had possessed a core group of organic units of platoon or company size that would have enabled them to augment or compliment the capabilities of the squadrons.

Most of the problems of the group could have been solved by retaining a regimental organization, similar to that used by the standard infantry regiment. This would have permitted a more robust and balanced organization of three squadrons, allowing the proper retention of an adequate reserve and still sufficient combat power forward to be effective. The regimental headquarters would have also retained a base which would have included a small number of critical combat and combat

support assets with which the regiment could weight the effort and supplement the capability of the squadrons.

By contrast, the cavalry squadron proved to be a superior combat organization. Its major positive characteristic was that of organic combined arms at the squadron level. It suffered from the limitations of its equipment, but made up for this through versatility of tactical technique. The ability to execute a dismounted attack supported by organic tanks and indirect fire from mortars and assault guns, and then change the mission in minutes to a mounted pursuit at 30 miles an hour for extended distances, was unmatched by any battalion size organization in the Army. It was a flexibility that extended itself to the group and often permitted the squadrons to achieve successes in difficult tactical situations.

The key to the squadron's combined arms success, other than organization, was command and control. Command and control in cavalry squadrons was enhanced by the proliferation of radios through all levels such that every tactical vehicle mounted at least one. It was complimented by the 100% mobility of all assets. In addition, initiative and leadership resulting from training the platoons to operate independently and respond to radio directions, permitted the unit to disperse and concentrate at will. This characteristic, combined with its combined arms attributes, gave the cavalry squadron combat power out of proportion to its actual size and weapons capabilities. This permitted the squadron, doctrine to the contrary, to execute the traditional missions of cavalry as well as reconnaissance.



The cavalry reconnaissance troop, although having many of the same positive characteristics of the squadron, suffered due to a lack of combat power. Although the cavalry platoons and troops were not small organizations, they lacked heavy caliber fire power. The troop's primary weapons, the 37-mm gun, the machine gun (both .50 caliber and .30 caliber) and the 60-mm mortar, were very effective against infantry in the open. They did not, however, have the power to affect protected enemy troops, particularly if they were equipped with armor, anti-armor weapons, or artillery. In these situations the platoons and troops were required to dismount and drive the enemy from their position through close combat with small arms and grenades. This mode of fighting, even if successful, forced the cavalry troop to give up most of the advantages of its organization. The troop was an effective reconnaissance organization, but unlike the squadron, it was not able to execute the other traditional missions of cavalry without routine support from the tank and assault gun elements of the squadron.

During the European Campaign the ratio of dismounted employment of cavalry to mounted employment for combat was 1.8 to 1. The absence of infantry within the cavalry structure was extremely limiting. Although dismounted cavalry action was a tactical solution which achieved much success, it came at the cost of giving up cavalry's mobility, fire power, command and control, and what little armor protection they had. Cavalry organizations were required to dismount regularly, because within the structure of the squadron the only combat arm that was not represented was infantry. Cavalry's success came despite the lack of infantry.

The cavalry's equipment ran the gamut from extremely good and useful to next to worthless. The best that can be said about the major pieces of cavalry equipment is that they were generally very reliable. The greatest limitation caused by equipment was the lack of offensive fire power relative to other mechanized units. The unit's greatest strength was its machine guns which gave it significant punch when dealing with infantry in fluid situations. In all other respects it was outgunned.

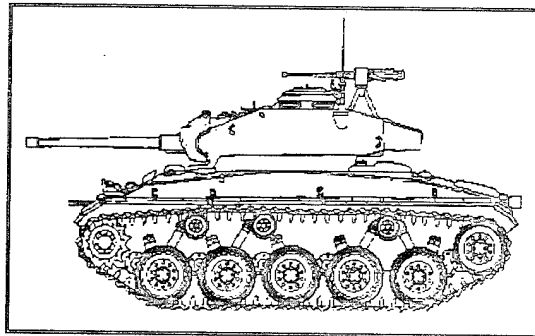

Figure 36. M24 Light Tank, General Chaffee. Source: Military Modeler, Drawing from "Chaffee, The M24 Light Tank," Military Modeler (December, 1989): 48.

The light tank was one of the cavalry squadron's greatest weaknesses, primarily because of the poor performance of the 37-mm gun. Because the armored car mounted the same gun, the tank contributed very little to the capability of the squadron. The problems experienced by the 14th Cavalry's ineffective counterattacks in the Ardennes demonstrates the difficulty the M5 light tanks had fulfilling their assigned doctrinal role of supporting the reconnaissance troops. In February, 1945, cavalry units began receiving the M24 General Chaffee

tank (see figure 36). This tank, in contrast to the M5, mounted a 75-mm gun which was more effective against German armor, and could penetrate the Panther tank from the flank. Colonel Reed, commander of the 2d Cavalry Group, believed that the M24 was not perfect, but it did allow cavalry to operate in the presence of enemy armor.<sup>88</sup> This tank was a welcome addition to the squadron, and the squadron commanders felt that it made the tank troop a viable organization. The problem that cavalry had was not with the armor protection of its vehicles, particularly its tanks, but rather with the tank killing capability. The General Board made no mention of inadequate armor, but did urge that every effort be made to adapt an effective anti-tank gun to the light tank.

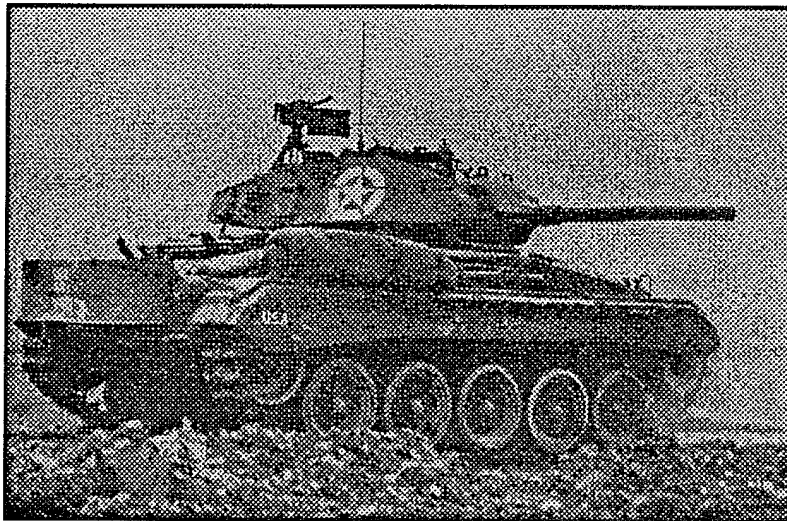

Figure 37. M24 Light Tank in Action, 117th CRS, 1945. Source: US Army Photo reproduced in Zaloga, 42.

The armored car posed a different problem for cavalry. In terms of mobility, combat commanders could not agree on the capabilities of

the armored car. In the European theater Lieutenant Colonel Jeff Collins, commander of the 125th CRS, decried the M8 armored car as an unsafe killer saying, "The M8 Armored Car is unquestionably a hazard to life, with its wide turning radius, particularly on narrow European road nets".<sup>89</sup> In contrast, the commander of the 81st CRS in Italy, Lieutenant Colonel Michael Popowski, said "the M8 is far superior [to the M3 White].... During my combat experience I saw only one instance where the armored car was not able to go where tanks went....Some of its capabilities over a tracked vehicle are: quietness, range, maintenance, and weight, which are all important in reconnaissance."<sup>90</sup> The one area that all could agree upon was the unsuitability of the 37-mm gun. It appears that the M8's greatest asset was its road speed, and, in contrast to the jeep scout vehicle, its armor and armament. This permitted some stealth when required, but allowed troops and platoons to use speed for protection and surprise; fight when they had to; and retreat when necessary. The tactical role of the armored car was support of the reconnaissance jeeps. Given this role, and its capabilities, cavalry leaders were not opposed to replacing the armored car with the light tank.

The jeep scout vehicle stood up well to cavalry operations in the European theater. Casualties were incurred due to the lack of armor protection, but cavalrymen seemed to consider this the price of doing business. The General Board recommended only that an armored windshield be added to give protection from forward small arms fire.

The assault gun troop demonstrated the faith placed in the system as a result of actions in North Africa. The M8 full tracked gun motor

carriage increased the system's mobility. Its rapid and responsive fires were key to making up for the lack of heavy caliber fire power in the reconnaissance troops and the squadron. Often, as in the case of the 2d Cavalry at Luneville, they spelled the difference between tactical success and failure. The only complaint about the gun was that it be updated to a 105-mm version which was standard in the armored artillery battalions.<sup>91</sup>

As World War II ended, three general conclusions regarding cavalry doctrine were apparent. The first conclusion was that doctrinal limitation of the mechanized cavalry to the reconnaissance mission which existed prior to and during the early part of the war was incorrect. The second was that mechanized cavalry was the one and true successor of horse cavalry, and that in combat it had assumed all of the traditional doctrinal missions of horse cavalry. The General Board supported this conclusion, restating the basic tenet of FM 2-15: "the mission of mechanized cavalry should be combat."<sup>92</sup> The third conclusion was that mechanized cavalry demonstrated a capability to profoundly influence the structure of the battlefield through economy of force operations at the corps and army level. These conclusions were validated by the General Board which made the judgment that the tactical doctrine of cavalry should be that of FM 2-15, based on the characteristics of cavalry as a light, heavily armed, and highly mobile force.<sup>93</sup> An expression of the General Board's conclusions was the recommended redesignation of all mechanized cavalry as simply "cavalry," as an indication of the predominant position of mechanized cavalry over horse cavalry.<sup>94</sup>

The experience and conclusions resulting from the employment of mechanized cavalry by the US Army in the European theater during World War II were applied to the reorganization of the Army immediately after the war. Those experiences have had a profound effect on the Army in the 50 years since the war. Finally, as the Army struggles with post cold war issues of doctrine and the organizations, and equipment to support them, the mechanized cavalry experience is vitally relevant.

### Endnotes

<sup>1</sup>Kent Roberts Greenfield, The Organization of the Ground Combat Troops (Washington DC: Office of the Chief of Military History, Department of the Army, 1947), 356.

<sup>2</sup>War Department, FM 100-5, Field Service Regulations (Washington D.C.: US Government Printing Office, 1944), 8-10.

<sup>3</sup>Ibid., 9-10.

<sup>4</sup>War Department, FM 2-15, Cavalry Field Manual, Employment of Cavalry (Washington D.C.: US Government Printing Office, 1941.), 5.

<sup>5</sup>Ibid., 5.

<sup>6</sup>War Department, FM 100-5, Field Service Regulations (1944), 8-9.

<sup>7</sup>US Army, The General Board, "Tactics, Employment, Technique, Organization and Equipment of Mechanized Cavalry Units" (United States Forces European Theater, 1945), 7.

<sup>8</sup>War Department, FM 2-15, Cavalry Field Manual, Employment of Cavalry, 8-9.

<sup>9</sup>George S. Patton, War As I Knew It (New York: Pyramid Books, Inc., 1966), 165.

<sup>10</sup>War Department, FM 2-15, Cavalry Field Manual, Employment of Cavalry, 56.

<sup>11</sup>D. J. Judge, "Cavalry in the Gap," Military Review (May, 1993): 56.

<sup>12</sup>Russell F. Weigley, History of the United States Army (New York: MacMillian Publishing Company, Inc., 1967), 448.

<sup>13</sup>Judge, 65.

<sup>14</sup>US Army, 14th Cavalry Group, "Action Against the Enemy, Report After, 1-31 December 1944" (10 January, 1945), 1.

<sup>15</sup>Judge, 59.

<sup>16</sup>Ibid., 59.

<sup>17</sup>US Army, 14th Cavalry Group, 1.

<sup>18</sup>Judge, 62.

<sup>19</sup>Charles B. MacDonald, A Time for Trumpets (New York: William Morrow and Co., Inc., 1985), 104.

<sup>20</sup>Ibid., 108.

<sup>21</sup>Ibid., 106.

<sup>22</sup>US Army, 14th Cavalry Group, 2.

<sup>23</sup>MacDonald, A Time for Trumpets, 109.

<sup>24</sup>US Army, 14th Cavalry Group, 1.

<sup>25</sup>MacDonald, A Time for Trumpets, 112.

<sup>26</sup>US Army, 14th Cavalry Group, 2.

<sup>27</sup>Ibid., 3.

<sup>28</sup>Ibid., 3.

<sup>29</sup>Christopher R. Gabel, The Lorraine Campaign: An Overview, September-December 1944 (Fort Leavenworth, KS: Combat Studies Institute, US Army Command and General Staff College, 1985), 21.

<sup>30</sup>US Army, 3d Cavalry Group (Mecz), "After Action Report, 1-30 Sept 44, incl." (4 October, 1944), 1.

<sup>31</sup>Gabel, The Lorraine Campaign: An Overview, September-December 1944, 20.

<sup>32</sup>Ibid., 21.

<sup>33</sup>US Army, 3d Cavalry Group (Mecz), "After Action Report, 1-30 Sept 44, incl.," 4.

<sup>34</sup>Ibid., 6.

<sup>35</sup>US Army, 3d Cavalry Group (Mecz), "After Action Report for Period 1-30 November 1944, incl." (4 December 1944), 1.

<sup>36</sup>US Army, 3d Cavalry Group (Mecz), "After Action Report, 1-30 Sept 44," 1.

<sup>37</sup>James H. Polk, "Letters and Notes of James H. Polk, 1944-1945," unpublished, 76.

<sup>38</sup>Ibid., 80.

<sup>39</sup>Ibid., 76.

<sup>40</sup>Ibid., 101.



<sup>41</sup>US Army, 3d Cavalry Group (Mecz), " After Action Report, 1-30 Sept 44," 5.

<sup>42</sup>Hugh M. Cole, US Army in World War II, The Lorraine Campaign (Washington DC.: Center for Military History, 1950), 162.

<sup>43</sup>Polk, 101.

<sup>44</sup>The General Board, app. 6, 5.

<sup>45</sup>Ibid., app. 6, 5.

<sup>46</sup>War Department, FM 100-5, Field Service Regulations (1944), 59.

<sup>47</sup>Ibid., 62.

<sup>48</sup>Ibid., 62.

<sup>49</sup>Gabel, The Lorraine Campaign: An Overview, September-December 1944, 15.

<sup>50</sup>Ibid., 16-17.

<sup>51</sup>Cole, US Army in World War II, The Lorraine Campaign, 91.

<sup>52</sup>Gabel, The Lorraine Campaign: An Overview, September-December 1944, 17.

<sup>53</sup>Cole, US Army in World War II, The Lorraine Campaign, 217.

<sup>54</sup>George Dyer, XII Corps, Spearhead of Patton's Third Army (XII Corps Historical Association, 1947), 216.

<sup>55</sup>US Army, 2d Cavalry Group (Mecz), "Report of Combat Operations 1 August - 5 November 1944" (Headquarters, 2d Cavalry Group, 5 November 1945), 11.

<sup>56</sup>Dyer, 212.

<sup>57</sup>Ibid., 212.

<sup>58</sup>Cole, US Army in World War II, The Lorraine Campaign, 222.

<sup>59</sup>Ibid., 221.

<sup>60</sup>Ibid., 221.

<sup>61</sup>US Army Armor School, "Research Report: Operation of Cav Rcn Sq Integral to the Armd Div" (Fort Knox, KY: US Army Armor School, 1950), 91.

<sup>62</sup>Hugh M. Cole, US Army in World War II, The Ardennes: Battle of the Bulge (Washington DC.: Center for Military History, 1965), 554.

<sup>63</sup>War Department, FM 2-15, Cavalry Field Manual, Employment of Cavalry, 38.

<sup>64</sup>Bruce Jacobs, "In the Dash to Paris," National Guard (September, 1994): 72.

<sup>65</sup>J. Lawton Collins, Lightning Joe (Louisiana: Louisiana State University Press, 1979), 258.

<sup>66</sup>Donald E. Houston, Hell On Wheels (Novato, CA: Presido Press, 1977), 262.

<sup>67</sup>Ibid., 262.

<sup>68</sup>Houston, 262-264.

<sup>69</sup>Ibid., 265.

<sup>70</sup>Ibid., 272-273.

<sup>71</sup>US Army, 6th Cavalry Group, "Actions Against the Enemy, Report After, 1-31 January 1945" (Headquarters, 6th Cavalry Group, 2 February 1945), 2.

<sup>72</sup>Ibid., 3.

<sup>73</sup>Ibid., 4.

<sup>74</sup>US Army, 24th Cavalry Reconnaissance Squadron Mechanized, "History of 24th Cavalry Reconnaissance Squadron Mechanized from 5 June 1944 to 28 June 1944" (Headquarters, 24th Cavalry Reconnaissance Squadron, 14 October 1944), 1.

<sup>75</sup>US Army, 24th Cavalry Reconnaissance Squadron Mechanized, "History of 24th Cavalry Reconnaissance Squadron Mechanized from 5 June 1944 to 28 June 1944," 1.

<sup>76</sup>Ibid., 2.

<sup>77</sup>Ibid., 2.

<sup>78</sup>Ibid., 4.

<sup>79</sup>War Department, FM 2-15, Cavalry Field Manual, Employment of Cavalry, 5.

<sup>80</sup>US Army, 6th Cavalry Group, "Actions Against the Enemy, Report After, 1-30 August 1944" (Headquarters, 6th Cavalry Group, 1 September 1944), 1.

<sup>81</sup>Polk, 51.

<sup>82</sup>Ibid., 51.

<sup>83</sup>US Army, 113th Cavalry Group, "Action Against the Enemy, Report After, 1-31 December 1944" (Headquarters, 113th Cavalry Group, 5 January 1945), 17.

<sup>84</sup>US Army, 101st Cavalry Group, Wingfoot, Rhineland and Central Europe Campaigns: Official History, 101st Cavalry Group (Mechanized) (Weinheim: H. Diesbach, 1945), 25.

<sup>85</sup>US Army, 4th Cavalry Group, "Actions Against the Enemy, Report After" (Headquarters, 4th Cavalry Group, 9 November, 1944), 6.

<sup>86</sup>US Army Armor School, "Research Report: Operation of Cav Rcn Sq Integral to the Armd Div," 138.

<sup>87</sup>The General Board, 7.

<sup>88</sup>The General Board, app. 2., 7.

<sup>89</sup>US Army, Army Ground Forces, "Report, Subject: Army Ground Forces Board, Comments and Observations by 125th Cav. Rcn Sq. Mecz." (Washington D. C.: Headquarters, Army Ground Forces, Army War College, 7 Oct 1944), 3.

<sup>90</sup>US Army, Army Ground Forces, "Subject: Report by Lt Col Michael Popowski" (Washington D. C.: Headquarters, Army Ground Forces, Army War College, 28 Oct 44), 2.

<sup>91</sup>The General Board, 18.

<sup>92</sup>Ibid., 20.

<sup>93</sup>Ibid., 20.

<sup>94</sup>Ibid., 17.

## CHAPTER FIVE

### THE LEGACY OF THE MECHANIZED CAVALRY

Moving steadily with three armored cavalry squadrons on line, the 2d Armored Cavalry Regiment led the US VII Corps on its deep envelopment of the Iraqi Army in Kuwait on February 25, 1991. At 1555 hours the 2d Squadron of the regiment made contact with an Iraqi forward security outpost manned by a reinforced T72 tank battalion of the Republican Guard Tawakanlana Division. In less than 30 minutes the 37 tanks of the battalion, as well as the supporting BMP infantry fighting vehicles, were reduced to smoking ruins. All along the regimental front, similar actions were occurring as the regiment's squadron advanced through the enemy security forces. By darkness the cavalry had succeeded in its mission as the corps covering force: it had located the main body of the enemy, and successfully penetrated the enemy security zone.<sup>1</sup>

The success of the 2d Armored Cavalry Regiment, as well as the 3d Armored Cavalry Regiment, and the seven divisional cavalry squadrons employed during Operation Desert Storm, is directly attributable to the principles of cavalry doctrine, organization and equipment established by the mechanized cavalry experience of World War II. Not only did these experiences shape the doctrine and organization of the cavalry force of the cold war, they also form a blueprint for future Force XXI design into the twenty-first century.

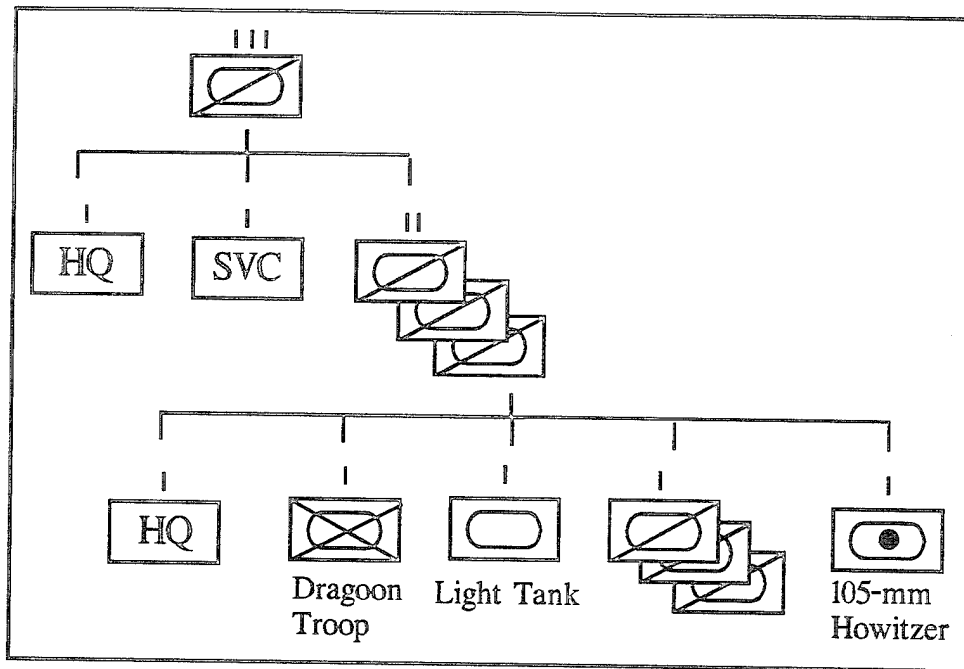

Figure 38. The General Board Recommended Cavalry Regiment.<sup>2</sup>

The doctrine and supporting organization and equipment of the US Army cavalry elements in the 1990s are directly attributable to the cavalry experience in World War II. As mentioned previously the General Board completed a very comprehensive study of the cavalry experience in the war. From this study emerged numerous recommendations. Key recommendations included the adoption of a three squadron regimental organization; the incorporation of all traditional cavalry missions into revised doctrine; and the inclusion of a significant amount of mechanized infantry in the organization. The board included its recommendations in a recommended regimental structure (see figure 38). Although the Army did not implement all of the recommendations of the board, they were the basis of the cavalry structure that emerged following the war.

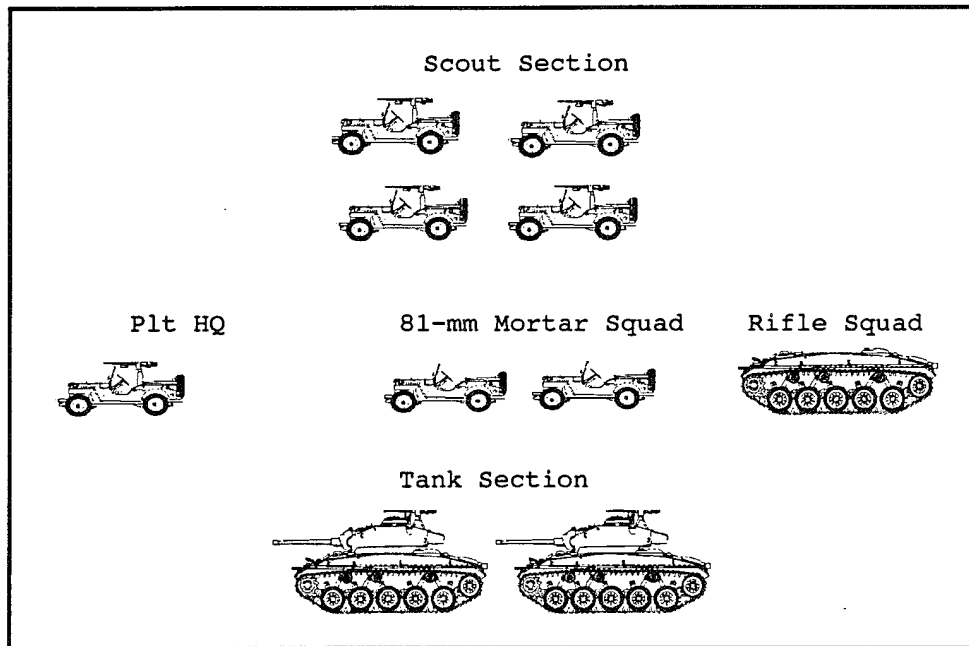

Figure 39. Reconnaissance Platoon, 1950.<sup>3</sup>

The history of cavalry after World War II is the story of a slow but steady increase in its organizational capabilities and the refinement of its doctrine. In 1948 the Army organized its first post war cavalry unit, the 3d Cavalry based in Fort Bliss, Texas. Based on a new table of organization and equipment, TOE 17-51, Cavalry Regiment (Light), the organization showed the definite influence of the General Board's recommendations. It included three reconnaissance battalions, a 105-mm self propelled assault gun troop in each battalion, and a reconnaissance company and platoon structure that included light tanks in the company, as well as infantry squads (see figure 39). The battalion also included a medium tank company at battalion level (see figure 40). The obvious intent of the organization was to eliminate the two major short-comings in the 1943 squadron structure: lack of anti-

tank capability, and inadequate dismounted infantry. The organization of this regiment permitted it to successfully accomplish the traditional missions of cavalry with its organic assets.

FM 17-95, The Armored Cavalry Regiment and the Armored Cavalry Reconnaissance Battalion, and FM 17-35, Reconnaissance Battalion, Armored Division, reflected updated doctrine for the new organization. The new doctrine stated that the mission of the reconnaissance battalion was "to engage in offensive or defensive combat, either mounted, dismounted, or a combination of both, primarily in execution of security and reconnaissance missions."<sup>4</sup> FM 17-22, Reconnaissance Platoon and Reconnaissance Company, indicated that the "reconnaissance platoon and company provide security and perform reconnaissance or light combat for units to which they are assigned or attached. For successful accomplishment of these missions, both the reconnaissance platoon and reconnaissance company are organized, equipped, and trained to attack, defend, or to delay."<sup>5</sup> The Army wrote these manuals specifically to replace their World War II counterparts, FM 2-15, FM 2-30, and FM 2-20, respectively. They make it very clear that combat missions, attack, defend, and delay, are the techniques utilized to accomplish the mission purposes of reconnaissance, and security.

In the 1950s, manuals did not capture the role of cavalry as an economy of force asset. The 1960 version of FM 17-35, now titled Armored Cavalry Platoon, Troop and Squadron, remedied this shortfall. The 1960 manual stated very clearly the missions of cavalry: "The armored cavalry squadron performs three types of missions: reconnaissance, security, and economy of force."<sup>6</sup> These same missions

applied at the troop level.<sup>7</sup> The specific missions the manual listed for the squadron included deep and wide ranging reconnaissance; covering and screening force; rear area security; offensive and defensive combat; liaison; and communications.<sup>8</sup> This list is virtually identical to the list of missions assigned to horse cavalry in FM 2-15 written in 1941.

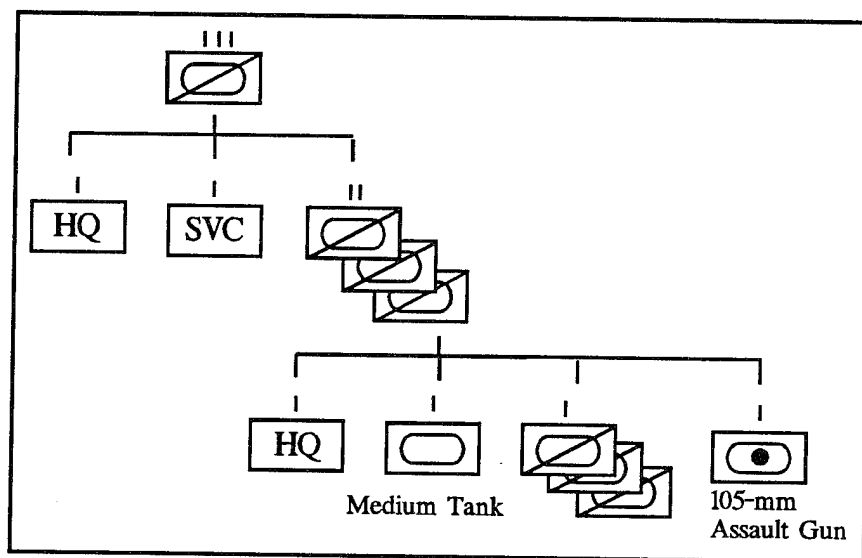

Figure 40. Armored Cavalry Regiment (light) and Reconnaissance Battalion, 1948.<sup>9</sup>

The 1950 and 1960 cavalry manuals together demonstrate that the Army completely internalized the major lessons regarding the cavalry experience in World War II. The manuals reflected the requirement for combat to achieve successful reconnaissance. They discussed the wide ranging missions expected of cavalry. These missions included all of the traditional missions of horse cavalry. Finally, the 1960 manual accurately defines the cavalry's role as a unit specifically designed to undertake missions for the purpose of economy of force.



The doctrine of cavalry remained constant throughout the cold war years, 1950 to 1991. The current cavalry doctrine reflected in the 1991 manual FM 17-95, Cavalry Operations, still remains consistent to the roles and missions defined in the 1950s and early 1960s. FM 17-95 states:

The fundamental roles of cavalry are to perform reconnaissance and provide security in close operations. Doing so, cavalry facilitates the corps or division commander's ability to maneuver divisions, brigades and battalions; concentrate superior combat power; and apply it against the enemy at a decisive time and place. Cavalry clarifies, in part, the friction of battle. Cavalry is, by its role, an economy of force. The flexible capabilities of cavalry allow the commander to conserve the combat power of division or brigades for engagement where he desires. The combat power of armored cavalry units, in particular, makes them ideal for offensive and defensive missions as an economy of force.<sup>10</sup>

Thus, the current manual clearly assigns to modern armored cavalry the same roles and missions recommended by the General Board at the conclusion of World War II.

Cavalry organizations also remained relatively consistent throughout the Cold War. The mixed cavalry platoon that originated in World War II remained the standard, notwithstanding changes in equipment types, through the mid 1980s (see figure 41). The Army eliminated the mixed platoon in the 1980s in favor of pure platoons, although the combined arms structure of the troop and squadron remained unchanged. The current regimental, squadron and troop organizations all reflect the combined arms philosophy practiced and validated in World War II, including the lesson of the requirement for organic combat power to accomplish the cavalry mission (see figure 42).

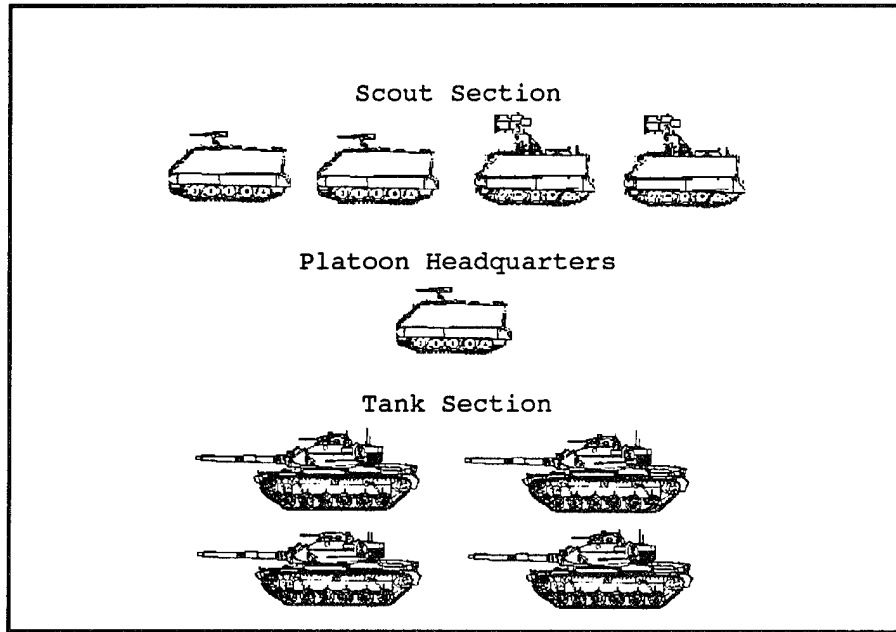

Figure 41. H-Series Cavalry Platoon, 1981.

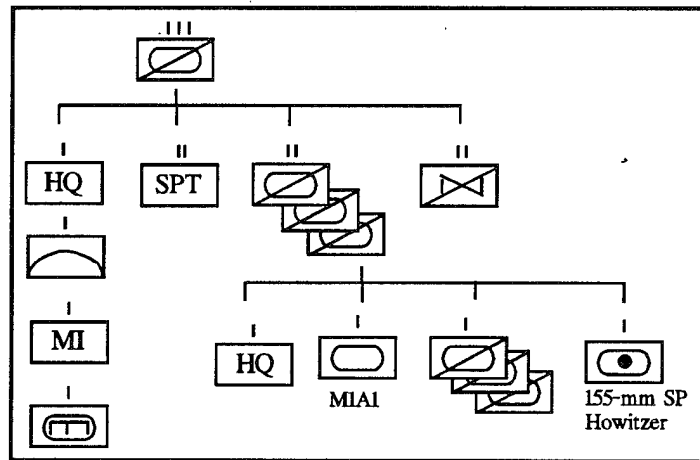

Figure 42. Current Armored Cavalry Regiment.

Operational experiences since the Second World War have reinforced the validity of the post war design of cavalry doctrine and organizations. Cavalry units were key players in the Vietnam Conflict,

cold war operations and plans in Europe, and most recently Operation Desert Storm. Cavalry's absence from the Korean War is noteworthy in that at least one distinguished military professional, General James M. Gavin, blames the absence of cavalry for the defeats the US Army suffered in the first year of the war. The inability of US forces to stop or even delay significantly the attack of the North Koreans south to Pusan is attributed by Gavin to the lack of cavalry. He maintains that a cavalry task force should have been given the delay mission that ultimately fell to the unfortunate Task Force Smith and later the 24th Infantry Division.<sup>11</sup> He also maintains that the surprise and success of the Chinese counterattack against the X Corps in the winter of 1950 were due to the failure to deploy and employ cavalry. Cavalry regiments and squadrons would have provided security forward and to the flanks of the American main body, and delayed the Chinese once the attack was discovered.<sup>12</sup> The failures that befell the Army when it operated without cavalry in Korea demonstrate the impact of cavalry on operations.

Cavalry units deployed to Vietnam despite the objections of some senior leaders. The cavalry force in Vietnam eventually totaled a half dozen divisional squadrons and the entire 11th Armored Cavalry Regiment. The cavalry's effectiveness, attributed to mobility, command and control, and fire power, surprised many senior officers. General William C. Westmoreland, initially opposed to the use of armor in Vietnam, changed his mind after viewing armored cavalry squadrons in action:

The ability of mechanized cavalry [his use of the WW2 terminology is interesting] to operate effectively in the Vietnamese countryside convinced me that I was mistaken in a

belief that modern armor had only a limited role in the fighting in Vietnam...their firepower and psychological impact elsewhere would be reason enough to employ them.<sup>13</sup>

The same characteristics that had made cavalry an effective force on the World War II battlefield proved invaluable in the totally different conditions of Vietnam.

Desert Storm, as indicated earlier, was the ultimate achievement of the cavalry force since World War II. In Desert Storm the cavalry units, particularly the regiments, performed superbly, executing all the traditional missions of cavalry passed down through the mechanized cavalry. Desert Storm demonstrated, to a degree well beyond Korea and Vietnam, that the doctrine, organization, and equipment of the Army's current armored cavalry forces is effective and correct.

#### Comments on Current Cavalry

Despite the success of the current cavalry force in Operation Desert Storm, the World War II experiences and lessons learned point out some aspects of the force structure and doctrine worth examining.

Today the US Army has two types of cavalry regiments: a light force design represented by the 2d Cavalry Regiment; and a heavy force structure in the 3d Armored Cavalry Regiment. Having two cavalry forces is inefficient and a luxury a small Army cannot afford. The 3d Armored Cavalry Regiment, equipped with tanks and cavalry fighting vehicles, emphasizes the cavalry characteristic of fire power. The 2d Cavalry Regiment, equipped with a combination of TOW and .50 caliber equipped High Mobility Multipurpose Wheeled Vehicles (HMMWV) emphasizes the cavalry characteristic of mobility. Both regiments retain the three ground squadron organization. The basic premise of the two regimental

designs is that the characteristics of fire power and mobility are mutually exclusive. The truth of this premise will change with the arrival of the Armored Gun System (AGS) in the near future.

Current force structure plans will field the AGS only to the 2d Cavalry Regiment. This ignores the lesson of World War II that emphasized the critical importance of both fire power and mobility. The major advantage of the M1 tank is its fire power. The protection of the tank is of secondary importance in cavalry operations, and certainly is much lower in priority than mobility. Not a single cavalry leader in World War II expressed dissatisfaction with the armor protection of the light tank, even though every anti-armor weapon in the enemy arsenal could penetrate its front armor. They were unanimous in their avocation of mobility. The Army should give serious consideration to fielding only a single regimental cavalry structure, one based solely on an AGS and scout combination that is truly mobile in both the tactical and strategic sense, and can fight effectively against armor. Main battle tanks, consolidated in the squadron tank company as was done in the 1948 organization, allows them to still provide vital support while distracting less from the unit's mobility. This organization would be very capable of performing all the traditional missions of cavalry. Such a course would give the Army two effective cavalry regiments which is absolutely essential when conducting multiple corps operations or dealing with two simultaneous regional contingencies. They would both be lethal combat organizations. Most importantly, they would both be strategically and tactically mobile.

Another debate that has arisen since Operation Desert Storm is the importance of brigade level reconnaissance. Operations during Desert Storm indicated to many brigade and division commanders that a brigade level reconnaissance element is an absolute necessity. The after action report of the 1st Armored Division stated, "had the division been employed in a more spread out configuration, brigade scouts would have been employed."<sup>14</sup> US Army Armor School observers and most of the other divisions that took part in the operation echoed this view.

World War II experience recognized the same need as Desert Storm identified. The 4th Armored Division's organization of cavalry in its attack to Bastogne in December 1944 demonstrated this point. Doctrine and organization in World War II, however, anticipated the requirement for brigade level reconnaissance and provided a fourth cavalry troop (Troop.D) in the squadron organization, for that purpose. In protracted combat it is likely that modern divisions will follow the lead of the World War II divisions and the views of Desert Storm leaders, and attach the divisional cavalry troops to the division's brigades as a normal practice. This will greatly reduce the usefulness of the division squadron to the division commander, as it did in World War II. Recognition of this likely reality should be a part of the debate regarding the requirement for brigade scouts, and argues for the increasing the number of troops in the division cavalry squadron to four.

Since the adoption of the "J Series" and Army of Excellence (AOE) tables of organization and equipment in the mid 1980s the cavalry

platoons of the divisions and the regiment have "pure" organizations. Pure tank platoons consist of four tanks, and pure scout platoons, consisting of six cavalry fighting vehicles. This breaks sharply with the traditions of the mixed cavalry platoon established with the armored car and motorcycle mix in 1940. The primary justification for the pure platoon configuration is to ease of command and control burden on the junior leader, the platoon leader, and centralize the responsibility for combined arms synchronization in the most experienced leader, the troop commander. Also contributing to the decision was the unavailability of modern supporting equipment when M1 tank and M3 cavalry vehicle were fielded in the early 1980s.<sup>15</sup> This however ignores the operational reality of how the troops fight, and the vehicle systems now available to the Army.

The World War II experience indicates that the cavalry regiment and squadron cover large areas of terrain. In addition, divisional squadrons will often have to give up elements attached to brigades. Both of these operational missions call for platoons to operate beyond mutually supporting distance from each other. Since the advent of the pure platoon, the reality of mission requirements in the 11th ACR in Germany, the 1st Squadron, 4th Cavalry (1st Infantry Division) during Desert Storm,<sup>16</sup> and most recently, the 3d ACR at the National Training Center (NTC), have all caused units to return to the mixed platoon in one form or the other. The bottom line should be that operational requirements, not the experience level of the platoon leader, should drive the organization and configuration of the platoon. The experience of World War II indicates that cavalry platoons will operate

independently and only concentrate for decisive combat. Vietnam, Desert Storm, and peace time operations in Germany and the NTC confirm this view. The platoon should be organized in accordance with how it will fight, not what is easiest for the peace-time Army to train to. This mandates a return to the mixed cavalry platoon.

#### Force XXI

As the Army downsizes and moves toward the twenty-first century, the Army's leadership is looking at radically different force designs and doctrinal concepts that will optimize emerging information technology. Force XXI represents these organizational concepts. The modern Armored Cavalry Regiment with its air component, and inherent combined arms, embodies all the characteristics demonstrated by cavalry on the World War II battlefield. These characteristics -- flexibility, command and control, mobility, and fire power -- make the cavalry force structure the perfect vehicle to harness and exploit information technology.

World War II demonstrated the flexibility of the cavalry organization to meet the wide variety of missions thrust upon it. Brigadier General Morris J. Boyd, Deputy Chief of Staff for Doctrine at the Army's Training and Doctrine Command (TRADOC), referring to the requirements of Force XXI units wrote, "the Army's unique mission capabilities will bring units to the future battlefield capable of conducting multiple missions."<sup>17</sup> Commanders in World War II used cavalry to conduct an army-wide information service; attacked dismounted to seize built up areas and forests; defended a corps size



sector; led corps and armies in pursuit; fought head to head with panzers; and managed refugees; all without ever significantly changing its basic organization. This record demonstrates a unique flexibility not found in any other organizational structure. Force XXI units will require this type of flexibility to operate in the widest variety of operational environments and simultaneously execute numerous missions. The combined arms cavalry force structure has that flexibility.

Force XXI units will be built around the ability to manage information. The design of World War II cavalry units optimized the advanced information system of that era: the radio. No other organization relied upon the radio to the extent that cavalry did. It made possible the type of independent company and platoon operations demonstrated in the 82d Reconnaissance Battalion's dash across France and Belgium in August 1944. Current cavalry organizations equally stress the importance of command and control, and situational awareness, and push the capabilities of radio communications to the limit in that respect. The current cavalry organization emphasizes information management as a key component. The existence of the Troop level Tactical Operations Center (TOC) is specifically for this purpose. The Army, as it fields sophisticated information systems, should consider the cavalry organizational model for incorporating them.

Mobility, both tactical and strategic, will be key in Force XXI organizations because of the likelihood that the unit will be strategically projected into theater and then move itself tactically with organic assets. World War II cavalry units were the most tactically mobile forces in the Army due to the range and speed of their

wheeled reconnaissance vehicles. Current cavalry units achieve tactical mobility through the application of their air cavalry components and through the responsiveness of their command and control system. Tactical mobility permits a small force to control large expanses of terrain; disperse for protection and auxiliary missions; concentrate rapidly for combat; and avoid decisive engagement under unfavorable conditions. These are all characteristics that cavalry demonstrated in combat in World War II, and which Force XXI units require in the twenty-first century.

Strategic mobility is another matter. Strategic mobility was not a major issue in World War II, but is to the contingency based Army of the future. The current heavy cavalry structure is not strategically mobile, although the light cavalry regiment is. Restructuring the cavalry regiment as discussed previously to achieve an optimum balance of strategic mobility and fire power, based on the AGS, is the solution to this problem. The successful cavalry experience of World War II supports the viability of an AGS equipped force to perform in any operational environment, including high intensity combat.

Force XXI should also heed the doctrinal lesson learned by cavalry in World War II regarding stealth versus combat. Many adherents of Force XXI predict an informational battlefield where technique and technology will suffice to inform the commander about the enemy. World War II proved that a smart enemy will actively deny information sought through passive measures. The US Army must be prepared to fight for information. This will require specially trained and equipped cavalry. The Army must take care to recognize that the inadequacies and inability

of the Iraqi Army to successfully deny intelligence to passive sensors does not set a precedent for the future. An enemy as unprepared for modern war as the Iraqi will be rare. Force XXI will need a reconnaissance element that is especially trained for close reconnaissance, and prepared to fight for information if necessary.

The World War II cavalry and its modern descendants have demonstrated themselves to be particularly effective tools for operational economy of force. The reason for this effectiveness has been the tactical characteristics of mechanized cavalry: flexible and versatile command and control; mobility; combined arms; and fire power. Force XXI will also be an economy of force tool, but will fulfill that role at both the operational and strategic level. Force XXI units must be able to fight independently against superior enemies to permit the US Army the time and space to project its combat power into a contingency theater. Because of their shared economy of force roles, Force XXI must embody similar characteristics, and organization as mechanized cavalry.

Fire power and lethality will be hallmarks of Force XXI. The World War II mechanized cavalry had a combat capability out of proportion to its actual size. Current cavalry force structures retain that characteristic. This is a result of a mixture of weapons systems capabilities, a high system to personnel ratio, and integration of systems at the lowest level. The combined arms structure of cavalry can give a similar lethality to Force XXI.

As the Army wrestles with the issue of designing itself for the twenty-first century one of the issues it will confront is the paradigm of the combat arms branch structure. Twentieth century military

doctrine has recognized the ascendancy of combined arms operations. The reality of this ascendancy is that combined arms forces are inherently superior to any single branch structure. The only US Army unit which has practiced this truth consistently for the last fifty years is the mechanized and armored cavalry. It is one reason why mechanized cavalry was successful on the World War II battlefield in spite of inadequate doctrine and equipment. What the Army must recognize in Force XXI is that the characteristics of combined arms incorporated and validated by cavalry can no longer be the sole prerogative of cavalry organizations. The combined arms cavalry structure developed in World War II and refined since then should become the basis for the Army's future standard fighting unit: Force XXI.

#### Conclusions

The World War II mechanized cavalry experience is remarkable for its variety and scope, and for the extent to which it has been ignored by both popular and academic history. World War II cavalry units participated in virtually every major campaign and battle in the European theater. They were remarkably effective in every task assigned, and they literally conducted every conceivable mission type the Army could have required of a combat unit with the exception of an airborne assault. Amazingly, World War II cavalry's accomplishments came with a written doctrine that had virtually no relationship to the reality of the battlefield, and with an organization and equipment designed to accomplish only one narrow aspect of the actual operational missions assigned.

The World War II cavalry doctrine proved to be woefully inadequate to the experience of the mechanized cavalry in combat. However, that experience provided the foundation of the armored cavalry doctrine and organizations that followed and which served the Army with particular effectiveness in Vietnam and Desert Storm. The sound principles of mobility, command and control, fire power, and combined arms were the basis for its success. These principles, embodied in the past and current cavalry structure, should not be ignored when looking forward to future Force XXI unit design. Ultimately the mechanized cavalry experience in World War II validated the original concept envisioned by General Daniel Van Vooris in the 1930s of a cavalry force that performed all of the traditional missions of cavalry, but substituted motor power for the horse.

### Endnotes

<sup>1</sup>Robert H. Scales, Certain Victory, The US Army in the Gulf War (Washington D.C.: Office of the Chief of Staff, US Army, 1993), 261-262.

<sup>2</sup>US Army, The General Board, "Tactics, Employment, Technique, Organization and Equipment of Mechanized Cavalry Units" (United States Forces European Theater, 1945), app. 13, 2.

<sup>3</sup>US Army, FM 17-22, Reconnaissance Platoon and Reconnaissance Company (Washington D.C.: Government Printing Office, 1950), 4.

<sup>4</sup>US Army, FM 17-35, Reconnaissance Battalion, Armored Division (Washington D.C.: Government Printing Office, 1951), 3.

<sup>5</sup>US Army, FM 17-22, Reconnaissance Platoon and Reconnaissance Company, 3.

<sup>6</sup>US Army, FM 17-35, Armored Cavalry Platoon, Troop, and Squadron (Washington D.C.: Government Printing Office, 1960), 159.

<sup>7</sup>Ibid., 88.

<sup>8</sup>ibid., 160.

<sup>9</sup>US Army, TO&E 17-51, Armored Cavalry Regiment (light) (Washington D.C.: Department of the Army, 1948), 3.

<sup>10</sup>US Army, FM 17-95, Cavalry Operations (Washington D.C.: Government Printing Office, 1991), 1-1 to 1-2.

<sup>11</sup>James M. Gavin, "Cavalry and I Don't Mean Horses, Armor (May-June, 1954): 18.

<sup>12</sup>Ibid., 19.

<sup>13</sup>William C. Westmoreland, A Soldier Reports (New York: Doubleday & Company, Inc., 1976), 216-217.

<sup>14</sup>US Army, 1st Armored Division, "Preliminary Lessons Learned During Operation Desert Storm" (Headquarters, 1st Armored Division, 19 March 1991), 1.

<sup>15</sup>Jim Pigg, "Why Cav Changed in the Seventies," Armor (January - February, 1995): 3.

<sup>16</sup>Robert Wilson, Letter to the Deputy Commander, US Army Armor Center, undated.

<sup>17</sup>Morris J. Boyd, "Information Operations," Military Review (November 1994): 22.

## BIBLIOGRAPHY

### Books

- Baily, Charles, M. Faint Praise, American Tanks and Tank Destroyers during World War II. Hamden: Archon Book, 1983.
- Blumenson, Martin. The Patton Papers, 1885-1940. Boston: Houghton Mifflin Company, 1972.
- \_\_\_\_\_. The Patton Papers, 1940-1945. Boston: Houghton Mifflin Company, 1972.
- Boniface, J. M. US Army Vehicles of World War Two. Somerset: Haynes Publishing Co., 1991.
- Cole, Hugh M. US Army in World War II, The Ardennes: Battle of the Bulge. Washington D.C.: Center for Military History, 1965.
- \_\_\_\_\_. US Army in World War II, The Lorraine Campaign. Washington D.C.: Center for Military History, 1950.
- Collins, J. Lawton. Lightning Joe. Baton Rouge, Louisiana: Louisiana State University Press, 1979.
- Dyer, George. XII Corps, Spearhead of Patton's Third Army. XII Corps Historical Association, 1947.
- Frankel, Nat and Larry Smith. Patton's Best. New York: Harthorn Books, Inc., 1978.
- Gabel, Christopher R. The US Army GHQ Maneuvers of 1941. Washington D.C.: Center of Military History, United States Army, 1991.
- Gillie, Mildred Hanson. Forging the Thunderbolt. Harrisburg, PA: Military Service Publishing, 1947.
- Greenfield, Kent Roberts. US Army in World War II, The Organization of the Ground Combat Troops. Washington D.C.: Office of the Chief of Military History, Department of the Army, 1947.
- Greenfield, Kent Roberts, editor. US Army in World War II, Pictorial Record: The War Against Germany: Europe and Adjacent Areas. Washington D.C.: Center for Military History, 1951.

- \_\_\_\_\_. US Army in World War II, Pictorial Record: The War Against Germany and Italy: Mediteranean and Adjacent Areas. Washington D.C.: Center for Military History, 1951.
- Herr, John K. and Edward S. Wallace. The Story of the US Cavalry, 1775 to 1942. New York: Bonanza Books, 1953.
- Houston, Donald E. Hell On Wheels. Novato, CA: Presido Press, 1977.
- Howe, George F. US Army in World War II, Northwest Africa: Seizing the Initiative in the West. Washington D.C.: Center for Military History. 1957.
- \_\_\_\_\_. The Battle History of the 1st Armored Division, "Old Ironsides." Washington: Combat Forces Press, 1954.
- MacDonald, Charles B. US Army in World War II, The Last Offensive. Washington D.C.: Center for Military History, 1973.
- \_\_\_\_\_. US Army in World War II, The Siegfried Line Campaign. Washington D.C.: Center for Military History, 1963.
- \_\_\_\_\_. A Time for Trumpets. New York: William Morrow and Co., Inc., 1985.
- Ogorkiewicz, R. M. Armoured Forces. New York: Arco Publishing Company, Inc, 1960.
- Palmer, R. R. US Army in World War II, The Procurement and Training of Ground Combat Troops. Washington D.C.: Historical Division, Department of the Army, 1948.
- Patton, George S. War As I Knew It. New York: Pyramid Books, Inc., 1966.
- Perret, Geoffrey. There's a War To Be Won. New York: Random House, 1991.
- Perrett, Bryan. German Armored Cars and Reconnaissance Half-tacks, 1939-45. London: Osprey Publishing Ltd., 1982.
- \_\_\_\_\_. The Stuart Light Tank Series. London: Osprey Publishing Ltd., 1980.
- Sawicki, James A. Cavalry Regiments of the US Army. Virginia: Wyvern Publications, 1985.
- Scales, Robert H. Certain Victory, The US Army in the Gulf War. Washington D.C.: Office of the Chief of Staff, US Army, 1993.
- Sorely, Lewis. Thunderbolt. New York: Simon and Schuster, 1992.



Stubbs, Mary Lee and Connor, Stanely R. Army Lineage Series: Armor-Cavalry Part I: Regular Army and Army Reserve. Washington D.C.: Center of Military Hisrory, 1969.

The Cavalry Journal. Modern Reconnaissance. Harrisburg: The Military Service Publishing Company, 1944.

Todd, Keith. 11th US Cavalry: Blackhorse. Paducah, KY: Turner, 1990.

Truscott, Lt. Gen. L. K. Jr. Command Missions. E.P. Dutton and Co., 1954.

\_\_\_\_\_. The Twilight of the US Cavalry. Lawrence, Kansas: University Press of Kansas, 1989.

Weigley, Russel F. History of the United States Army. New York: MacMillian Publishing Company, Inc., 1967.

Westmoreland, William C. A Soldier Reports. New York: Doubleday & Company, Inc., 1976.

White, B. T. Tanks and Other Fighting Vehicles, 1942-45. Dorset, England: Blandford Press, 1975.

Zaloga, Steven. Stuart, U.S. Light Tanks in Action. Carrollton, TX: Squadron/Signal Publications, Inc., 1979.

#### Periodicals and Articles

Bixel, C. P. "Cavalry Motorcycle Troop." The Cavalry Journal (January-February, 1941): 52-55.

Boyd, Morris J. "Information Operations." Military Review (November 1994): 22.

"C.O.'s of Cavalry Units." The Cavalry Journal (July/August, 1941): 110.

Gavin, James M. "Cavalry, and I Don't Mean Horses." Armor (May-June, 1954): 18-22.

Grow, Robert W. "The Ten Lean Years, Part 1." Armor (January-February, 1987):22-30.

\_\_\_\_\_. "The Ten Lean Years, Part 2." Armor (March-April, 1987): 25-33.

\_\_\_\_\_. "The Ten Lean Years, Part 3." Armor (May-June, 1987):21-28.

\_\_\_\_\_. "The Ten Lean Years, Part 4." Armor (July-August, 1987): 34-42.

- Hawkins, Hamilton S. "Cavalry and Mechanized Force." The Cavalry Journal (September-October, 1931): 19-25.
- Hoy, Charles J. "Mechanics of Battlefield Reconnaissance." The Cavalry Journal (May-June, 1944): 24-29.
- Jacobs, Bruce. "In the Dash to Paris." National Guard (September, 1994): 72-76.
- Judge, D. J. "Cavalry in the Gap." Military Review (May, 1993): 53-67.
- "Mechanized Force Recommended." The Cavalry Journal (March/April, 1931): 112-113.
- "Mechanized Force Becomes Cavalry." The Cavalry Journal (May/June, 1931): 4-6.
- "Mechanized Cavalry." The Cavalry Journal (November/December, 1931): 53-54.
- Palmer, Bruce. "Mechanized Cavalry in the Second Army Maneuvers." The Cavalry Journal (November-December, 1936): 460-478.
- Parker, James. "The Mechanized Cavalry." The Cavalry Journal (September-October, 1931): 55.
- Patton, George S. Jr. "Mechanization and Cavalry." The Cavalry Journal (April, 1930): 234-240.
- Pigg, Jim. "Why Cav Changed in the Seventies," Armor (January - February, 1995): 3.
- Richardson, Robert R. "The Wider Role of Cavalry." The Cavalry Journal (January-February, 1941): 2-8.
- Sherburne, Thomas L.. "A Tribute To The Mechanized From An Old-Timer." The Cavalry Journal (November-December, 1936): 479-480.
- White, I.D. "Reconnaissance Battalion, Armored Division." The Cavalry Journal (May-June, 1941): 48-52.
- Wilson, Arthur. "The Mechanized Force, Its Organization and Present Equipment." The Cavalry Journal (May-June, 1931): 7-10.

Government Documents and Publications

- Gabel, Christopher R. Seek, Strike, and Destroy: US Army Tank Destroyer Doctrine in World War II. Fort Leavenworth, KS: Combat Studies Institute, US Army Command and General Staff College. 1986.

- . The Forth Armored Division in the Encirclement of Nancy.  
Fort Leavenworth, KS: Combat Studies Institute, US Army Command and General Staff College, 1986.
- . The Lorraine Campaign: An Overview, September-December 1944.  
Fort Leavenworth, KS: Combat Studies Institute, US Army Command and General Staff College, 1985.
- The General Board. "Mechanized Cavalry Units." United States Forces, European Theater, 17 June 1945.
- US Army, 1st Armored Division. "Preliminary Lessons Learned During Operation Desert Storm." Headquarters, 1st Armored Division, 19 March 1991.
- US Army, 2d Cavalry Group (Mecz). "Report of Combat Operations 1 August - 5 November 1944." Headquarters, 2d Cavalry Group, 5 November 1945.
- US Army, 3d Cavalry Group (Mecz). "After Action Report, 1-30 Sept 44, incl." Headquarters, 3d Cavalry Group, 4 October, 1944.
- US Army, 4th Armored Division. "Notes on Recent Operations." Headquarters, Combat Command A, 7 October, 1944.
- US Army, 4th Cavalry Group. "Actions Against the Enemy, Report After, 1-31 August." Headquarters, 4th Cavalry Group, 3 September 1944.
- US Army, 6th Armored Division. Combat Record of the Sixth Armored Division in the European Theater of Operations, 18 July 1944-8 May 1945. Aschaffenburg, Germany: G-3, US Army 6th Armored Division, 1945.
- US Army, 6th Cavalry Group. "Actions Against the Enemy, Report After, 1-31 August." Headquarters, 6th Cavalry Group, 1 September 1944.
- US Army, 6th Cavalry Group. "Actions Against the Enemy, Report After, 1-31 January 1945." Headquarters, 6th Cavalry Group, 2 February 1945.
- US Army, 14th Cavalry Group. "Action Against the Enemy, Report After, 1-31 December 1944." Headquarters, 14th Cavalry Group, 3 January 1945.
- US Army, 24th Cavalry Reconnaissance Squadron Mechanized. "History of 24th Cavalry Reconnaissance Squadron Mechanized from 5 June 1944 to 28 June 1944." Headquarters, 24th Cavalry Reconnaissance Squadron, 14 October 1944.
- US Army, 82d Reconnaissance Battalion. "After Action Report 82nd Amd Recon Bn 2nd Armored Division, June 44 thru May 45." Undated.

US Army, 101st Cavalry Group. Wingfoot, Rhineland and Central Europe Campaigns: Official History, 101st Cavalry Group (Mechanized). Weinheim: H. Diesbach, 1945.

US Army, 113th Cavalry Group. "Action Against the Enemy, Report After, 1-31 December 1944." Headquarters, 113th Cavalry Group, 5 January 1945.

US Army. FM 17-22, Reconnaissance Platoon and Reconnaissance Company. Washington D.C.: Government Printing Office. 1950.

\_\_\_\_\_. FM 17-35, Reconnaissance Battalion, Armored Division. Washington D.C.: Government Printing Office, 1951.

\_\_\_\_\_. FM 17-35, Armored Cavalry Platoon, Troop, and Squadron. Washington D.C.: Government Printing Office, 1960.

\_\_\_\_\_. FM 17-95. Cavalry Operations. Washington D.C.: Government Printing Office, 1991.

\_\_\_\_\_. TO&E 17-51, Armored Cavalry Regiment (light). Washington D.C.: Department of the Army, 1948.

US Army Armor School. "Research Report: Operation of Cav Rcn Sq Integral to the Armd Div." Fort Knox, KY: US Army Armor School, 1950.

US Army, Army Ground Forces. "Report, Subject: Extract from Overseas Reports. Immediate Report No. 55." Washington D. C.: Headquarters, Army Ground Forces, Army War College, 11 Oct 44.

\_\_\_\_\_. "Report, Subject: Army Ground Forces Board, Comments and Observations by 125th Cav. Rcn Sq. Mecz." Washington D. C.: Headquarters, Army Ground Forces, Army War College. 7 Oct 1944.

\_\_\_\_\_. "Subject: Report by Lt Col Micheal Popowski." Washington D.C.: Headquarters, Army Ground Forces, Army War College, 28 October, 1944.

\_\_\_\_\_. TC 107, "Mechanized Cavalry." Headquarters, Army Ground Forces, Army War College, 1943.

\_\_\_\_\_. Equipment Review Board, Part I: Board Study and Annexes. Washington D.C.: Headquarters Army Ground Forces, 1945.

US Army Cavalry School. Cavalry Combat. Fort Riley Kansas: The Cavalry School, 1937.

\_\_\_\_\_. Mechanized Cavalry, 1932-1933. Fort Riley Kansas: The Cavalry School, 1937.

- . FM 2-10, Cavalry Field Manual: Vol II, Mechanized Cavalry.  
Fort Riley KS: US Army Cavalry School, 1938.
  - . FM 2-10, Cavalry Field Manual: Mechanized Elements. Fort  
Riley, KS: US Army Cavalry School, 1941.
  - . FM 2-20, Cavalry Reconnaissance Troop, Mechanized. Fort Riley  
KS: US Army Cavalry School, 1944.
  - . FM 2-30, Cavalry Field Manual, Cavalry Mechanized  
Reconnaissance Squadron. Fort Riley KS: US Army Cavalry  
School, 1943.
  - . FM 2-7, Cavalry Drill Regulations, Mechanized. Fort Riley  
KS: US Army Cavalry School, 1944.
  - . Cavalry Reconnaissance, Number One: Operations of the 81st  
Armored Reconnaissance Battalion in Tunisia. Fort Riley KS: US  
Army Cavalry School, 1944.
  - . Cavalry Reconnaissance, Number Two: Operations of the 81st  
Armored Reconnaissance Battalion in Tunisia (Part III). Fort  
Riley KS: US Army Cavalry School, 1944.
  - . Cavalry Reconnaissance, Number Three: Operations of the 91st  
Cavalry Reconnaissance Squadron, Mechanized, From El Abiod to  
Mateur. Fort Riley KS: US Army Cavalry School, 1944.
  - . Cavalry Reconnaissance, Number Four: Operations of the 91st  
Cavalry Reconnaissance Squadron, Mechanized, From Mateur to  
Bizerte. Fort Riley KS: US Army Cavalry School, 1944.
  - . Cavalry Reconnaissance, Number Five: Operations of the 3d  
Cavalry Reconnaissance Troop, Mechanized (Part I- Sicily). Fort  
Riley KS: US Army Cavalry School, 1944.
  - . Cavalry Reconnaissance, Number Seven: Operations of a  
Reconnaissance Company in Tunisia. Fort Riley KS: US Army  
Cavalry School, 1944.
- War Department. "Mechanized Force Becomes Cavalry. May 18, 1931."  
The Cavalry Journal (May-June 1931): 5-6.
- . FM 2-15. Cavalry Field Manual, Employment of Cavalry.  
Washington D.C.: US Government Printing Office, 1941.
  - . FM 100-5. Field Service Regulations. Washington D.C.: US  
Government Printing Office, 1941.
  - . FM 100-5. Field Service Regulations. Washington D.C.: US  
Government Printing Office, 1944.

- FM 100-17. Field Service Regulations For Larger Units.  
Washington D.C.: US Government Printing Office, 1941.
- T/O 2-25, Cavalry Squadron, Reconnaissance, Mechanized, Cavalry Division, Horse. Washington D.C.: US Government Printing Office, 1940.
- T/O&E 2-25, Cavalry Reconnaissance Squadron, Mechanized.  
Washington D.C.: US Government Printing Office, 1943.
- T/O 2-27, Cavalry Troop, Reconnaissance, Mechanized, Cavalry Division Horse, and Cavalry Troop, Reconnaissance, Mechanized, Regiment, Horse and Mechanized. Washington D.C.: US Government Printing Office, 1940.
- T/O&E 2-27, Reconnaissance Troop. Washington D.C.: US Government Printing Office, 1943.
- T/O&E 2-28, Assault Gun Troop. Washington D.C.: US Government Printing Office, 1943.
- T/O 2-51, Cavalry Regiment, Horse and Mechanized.  
Washington D.C.: US Government Printing Office, 1940.
- T/O 2-65, Cavalry Squadron, Mechanized, Regiment, Horse and Mechanized. Washington D.C.: US Government Printing Office, 1940.
- T/O 17-35, Armored Reconnaissance Battalion. Washington D.C.: US Government Printing Office, 1940.
- T/O 17-35, Armored Reconnaissance Battalion. Washington D.C.: US Government Printing Office, 1942.
- T/O 17-37, Reconnaissance Company, Armored Regiment or Armored Reconnaissance Battalion. Washington D.C.: US Government Printing Office, 1942.

Unpublished Materials

- Polk, James H. "Letters and Notes of James H. Polk 1944-1945".
- Wilson, Robert. Letter to the Deputy Commander, US Army Armor Center. Undated.

INITIAL DISTRIBUTION LIST

1. Armor School Library  
US Army Armor Center  
Fort Knox, KY 40121
2. Cavalry Branch  
3/16 Cavalry  
US Army Armor School  
Fort Knox, KY 40121
3. Combined Arms Research Library  
U.S. Army Command and General Staff College  
Fort Leavenworth, KS 66027-6900
4. Lieutenant Colonel Dwain Crowson  
Reserve Component Director  
USACGSC  
Fort Leavenworth, KS 66027
5. Colonel (Retired) Thomas Dials  
12500 Knollwood Dr  
Leavenworth, KS 66048
6. Defense Technical Information Center  
Cameron Station  
Alexandria, VA 22314
7. Doctor Christopher R. Gabel  
Combat Studies Institute  
USACGSC  
Fort Leavenworth, KS 66027
8. Colonel Kain  
Combined Arms Tactics Center  
USACGSC  
Fort Leavenworth, KS 66027
9. Lieutenant Colonel Pablo Guevara  
Chilean Liaison Officer  
USACGSC  
Fort Leavenworth, KS 66027

10. Colonel Peter Wells  
5550 Renoir Lane  
Burke, VA 22015
  
11. Lieutenant Colonel (Retired) Ralph Shaw  
Headquarters, III Corps and Fort Hood  
Fort Hood, Texas 76542