

THIS FILE IS MADE AVAILABLE THROUGH THE DECLASSIFICATION EFFORTS AND RESEARCH OF:

# THE BLACK VAULT

THE BLACK VAULT IS THE LARGEST ONLINE FREEDOM OF INFORMATION ACT / GOVERNMENT RECORD CLEARING HOUSE IN THE WORLD. THE RESEARCH EFFORTS HERE ARE RESPONSIBLE FOR THE DECLASSIFICATION OF THOUSANDS OF DOCUMENTS THROUGHOUT THE U.S. GOVERNMENT, AND ALL CAN BE DOWNLOADED BY VISITING:

[HTTP://WWW.BLACKVAULT.COM](http://www.blackvault.com)

YOU ARE ENCOURAGED TO FORWARD THIS DOCUMENT TO YOUR FRIENDS, BUT PLEASE KEEP THIS IDENTIFYING IMAGE AT THE TOP OF THE .PDF SO OTHERS CAN DOWNLOAD MORE!

# Military Review

The Professional Journal of the United States Army

SEPTEMBER 1994

AD-A286 330

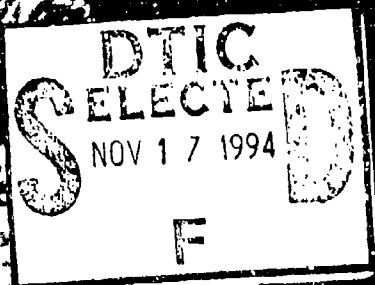

928



94-35498

This document has been approved  
for public release and sale; its  
distribution is unlimited.

US Atlantic Command and Somalia



# Military Review

Prepared by  
US ARMY COMMAND AND GENERAL STAFF COLLEGE  
VOLUME LXXIV - September 1994 - NO 9  
Professional Bulletin 100-54-9

**Lieutenant General**  
**John E. Miller**  
Commandant, USAAGSC

**Brigadier General**  
**Randall L. Rigby**  
Deputy Commandant, USAAGSC

**Military Review Staff**  
Colonel John W. Reitz  
Editor in Chief

Major Michael I. Riddin  
Managing Editor

Lieutenant Colonel George L. Humphries  
Editor, Latin American Edition

Philip R. Davis  
Production Editor

D. M. Gangreco  
Design Editor

Patricia L. Duen  
Books & Features Editor

Charles A. Martinson III  
Art and Design

Brenda C. Taylor  
Manuscript Editor

Billy L. Hammond  
Manuscript/Editorial Assistant

Patricia L. Wilson  
Secretary

Amos W. Galtbrink  
Editor Emeritus

Consulting Editors  
Colonel Angelo de Souza Pinheiro  
Brazilian Army, Greater Brazil

Lieutenant Colonel Pedro Pablo Galvan  
Chilean Army, Greater American Editor

By Order of the Secretary of the Army  
**ANDREW R. SULLIVAN**  
General, United States Army

*Milton H. Hamilton*  
MILTON H. HAMILTON  
Administrative Assistant to the  
Secretary of the Army

The Mission of Military Review is to provide a forum for the free exchange of ideas and information to be used in strategic planning and execution of the battle and training tasks of war, and to support the education, training, doctrine development and integration programs of the Commandant General and the Command and General Staff College.

Professional Bulletin 100-54-9 (Military Review) is published monthly, in English. The publication is published by the Commandant, USAAGSC, and the staff of the Command and General Staff College. The journal is published by the Commandant, USAAGSC, and the staff of the Command and General Staff College. The journal is published by the Commandant, USAAGSC, and the staff of the Command and General Staff College.

USAGSC is published monthly by the Commandant, USAAGSC, and the staff of the Command and General Staff College. The journal is published by the Commandant, USAAGSC, and the staff of the Command and General Staff College.

## CONTENTS

- 2 Letters
- 4 *US Atlantic Command and Somalia: A New Mission Focus*
- 5 *US Atlantic Command: Focusing on the Future*
- 12 *A Changing World, A Changing UN*
- 19 *A New Face in NATO*
- 26 *Rules of Engagement: Lessons from Restore Hope*
- 35 *Task Force 2-87: Lessons from Restore Hope*
- 42 *US Security Interests in the Pacific Rim*
- 51 *A Southeast Asia Scenario*
- 61 *Strategy for a Second Career*
- 68 *World War II Almanac: A Corridor to Nowhere*
- 74 *Insights: The FAO Soldier-Diplomat for the New World Order*
- 77 *Review Essay: Army, From Bruchmiller to the Great Divide*
- 79 *Book Reviews*

## *From the Editor*

In its 72-year history, the *Military Review* has reflected the Army's change in intellectual outlook and needs, and, in this next year, *MR* must also visibly share in the reduction of resources. In January 1995, *MR* will stop its monthly production for the first time since April 1943 and produce only six issues a year. After a consistent reduction in the size of the professional staff over the past five years, *MR* could not cut the production staff further and still provide a quality product. This choice obviously reduces the number of articles presented to our readers each year, but it will not change the quality or mission of the magazine. From an average of 95 articles a year with 12 issues, *MR* will eventually publish about 66 articles per year with six issues, thereby increasing the number of pages in each issue from 80 to 128. Our subscribers will receive information on how we will prorate their current subscriptions and the new rate schedule.

On a much grander scale, the new missions and structures of national and international military commands also reflect adaptation to the new environment. The range of operations and command structures deployed in Somalia, Rwanda, Haiti and the former states of Yugoslavia continually remind us that future operations will be complex and will be conducted by joint, combined and interagency teams. We are pleased to present as our lead article, "US Atlantic Command: Focusing on the Future," by Admiral Paul David Miller. He describes his concepts of force packaging and joint training that will "improve efficiency, reduce cost, increase the overall readiness of our forces and foster greater service interoperability" across the full range of military operations. Our theme of organizational response to new strategic postures and regional challenges continues in the other two articles of this section. Jan Goldman foresees new opportunities for relevance and an increased importance of UN military operations in "A Changing World, A Changing UN." "A New Face in NATO" by the commander of a combined Belgian, British, Dutch and German division, Major General Pieter Huysman, offers an informative discussion on how the Multinational Division (Central) organizes, trains and operates to project an effective force to share national responsibility at the tactical level. This month's second theme is captured in two excellent articles that examine lessons learned in Somalia during Operation *Restore Hope* and thereby offers a retrospective to US, UN and NATO forces to meet future challenges successfully.

In a departure from past practice of announcing a writing contest at the start of the calendar year, we want to launch the writing contest at the start of the academic year. *Joint Forces Quarterly* and *Parameters* have recently published some thoughtful articles on the revolution in military affairs, and *JFQ* is conducting a writing contest on the same topic. To complement their dialogue, *MR* will offer "*Defining Knowledge-Based Warfare in Theory or Application*" as its writing contest topic. This topic should allow contributors to tackle digitization, information operations at the tactical level, battle command, commander's intent and a host of other issues as the practice of warfighting changes with new technologies and concepts at the tactical and operational levels of war. Cash prizes of \$500 for first place, \$250 for second and \$100 for third will be awarded. See our October 1994 issue for more details.

**JWR**

NOTED QUALITY INSPECTED 5

# MR Letters

## A New Perspective on Digitization

The US Army is a highly effective organization, as exemplified by its performance during Operation *Desert Storm*. Digitization and increased weapons lethality will allow us to increase our efficiency. New technologies require a new way of commanding and operating on the battlefield. We can use lessons of the past to analyze the effect of assimilating new technology on the battlefield:

- Increased weapons lethality forces greater dispersion on the battlefield.
- New countermeasures, tactics and organizations develop in response to new weapons.
- Close terrain can neutralize technology.
- Larger organizations are more robust than smaller ones.
- Too much information can paralyze decision making.
- Communications advances increase the span of control.

The development of tactical nuclear weapons is one example of the above. We disperse to avoid the effects of nuclear blast, yet a method to avoid attack by nuclear weapons or air strikes is to "hug" the enemy force. Terrain limited the damage and casualties from nuclear blast at Nagasaki.

We also know a larger organization can withstand greater losses than a smaller organization. This is the reason assault battalions in World Wars I and II were as much as 25-percent overstrength.

Improved communications can provide increased organizational efficiency yet undermine the chain of command and paralyze decision making. The development

of the radio allowed the modern armored division to evolve. An example of "overcontrol" of an on-the-scene commander by one far away would be that of the Iranian hostage rescue mission or the spectacle of C<sup>2</sup> helicopters stacking up over a platoon fire fight in Vietnam.

Advanced weaponry, such as the fiber-optic guided missile with its 15-kilometer range, will allow us to rapidly concentrate weapons effects from an extremely dispersed force. Digitization may be the only way to provide effective control of such a force and offer nearly instantaneous communication of reports and orders, allowing everyone to see the same map simultaneously.

Digitized command links will make the loss of a headquarters less catastrophic. Digital links could be programmed to automatically seek out alternate headquarters in the event the primary command post is destroyed. Also, this technology offers the ability to increase the span of control, lessen the work load of commanders and staffs and possibly remove an echelon of command.

Obviously, these technologies will drive organizational change. We are correct in initially fielding this equipment on top of existing organizations, then making appropriate organizational changes after a period of examination. Advanced technologies have driven the change in the size of tank crews from five to three since the end of World War II. Another example is the reduction of the number of tanks in a platoon from five to four to take advantage of increasing weapons lethality.

If our new digitized command systems and weapons lethality offer a 40-percent increase in efficiency, then we have several options. We can reduce the number of units in current organizations and maintain the same lethality. Instead of a four-company, 58-tank battalion, field a three-company, 32-tank battalion. However, this arrangement does not take full advantage of the system since many manpower requirements would remain nearly the same for combat support and combat service support (CSS) personnel.

Instead, let us eliminate echelons of command and allow digitization to increase the span of control. We could eliminate battalions and have brigades control companies. Digitized command links should allow a single commander to control at least nine maneuver companies, a cavalry troop, a mortar battery, three artillery batteries and the necessary CSS functions. The brigade staff would increase, but we could eliminate three to five battalion staffs. This may bring back memories of the 1950s. The battle group was a battalion-size task force commanded by a colonel.

Another option is to eliminate brigades and control battalions directly from division level. This is a very attractive possibility. Brigade staffs are very small and have little CSS responsibility. Maneuver battalions coordinate directly with support battalions for most actions. Division commanders already monitor the fight at battalion, so this change would cause minimal organizational disruption. The Army could maintain the number of battalions in a division at nine

and make each one smaller, or keep each battalion the current size and reduce the number of battalions to six. Unit lethality should remain at current levels.

Finally, the Army could eliminate divisions and control independent brigades from corps. Each brigade would be the same size it is now, but increases in lethality would allow fewer brigades per corps than current levels. Since digitization will automate much of the CSS load, this option may have some merit.

This approach has some pitfalls, particularly as we look at reducing the number of soldiers in a battalion. Some activities remain manpower intensive. Putting tracks back on a tank is extremely difficult with only two people. The advent of the Bradley Fighting Vehicle, with its reduced dismount strength, prompted serious concerns about the strength of infantry squads. Other tasks such as clearing trench lines or built up areas require large numbers of men. Ammunition handling can be automated up to a point, but sooner or later, people will have to break the ammunition from shipping containers into a tank, howitzer or rear vehicle.

Our digitized force could run circles around a less advanced enemy. Battles, campaigns and wars could all be won with much less cost in lives and equipment. However, all advantages on the battlefield are fleeting. Other nations soon follow with the same or similar capabilities and countermeasures. A fight between two digitized forces is expected to be very lethal. Nations such as Saudi Arabia, Japan and most of Western Europe have the money and the technology to field such systems. Who among our future enemies will be the first to field advanced digitization on the battlefield of the future?

Increased lethality and digitization offer us immense opportunities. However, we need a lively

debate about exactly which, if any, organizational concepts we wish to adopt in the years ahead.

**MAJ Michael K. Robel, USAR,**  
*Hoover, Alabama*

## Is There Hope for MCS?

The US Army fielded the Maneuver Control System (MCS) in the mid-1980s, with the current MCS software—Version (V.)10, 03.1G1—fielded in 1991. There has been little improvement since, even though MCS has proved cumbersome and difficult to use. The MCS software is truly a training challenge for soldiers: it does not offer the commander and his staff the flexibility to obtain, manipulate and transmit all the critical combat information (common picture) they need around the battlefield, and its data base is somewhat limited in scope and size. In addition, the MCS non-developmental item (NDI) hardware is very bulky, weighing 800 pounds.

The bottom line is that MCS is not a user-friendly system. While some units employ MCS for its intended purpose—as a tool for maneuver command and control (C<sup>2</sup>)—other units use MCS as a glorified electronic mail system or even bypass the system with off-the-shelf commercial software such as the Command Tactical Information System.

In 1992, the Army Communications Electronics Command Software Engineering Directorate (CECOM SED), Fort Monmouth, New Jersey, assumed responsibility for MCS post-deployment software support. Since then, the only significant upgrade to the system has been the addition of the mobile subscriber equipment (MSE) packet upgrade which allowed MCS to become part of the Army's C<sup>2</sup> network within MSE. The MCS V11 software, which was to be fielded by fiscal year (FY) 1993, failed to meet

technical and operational requirements, and the Army terminated its development. This left MCS V.10.03.1G1 still in the field.

In FY 1993, the Combined Arms Center—Combat Developments, Fort Leavenworth, Kansas, requested CECOM SED to investigate and apply specific software enhancements to the MCS V.10, 03.1G1 system while simultaneous efforts to develop MCS V.12 were under way. CECOM SED, in partnership with the Army Experimentation Site, Fort Lewis, Washington, is in the process of fielding a number of enhancements to the MCS V.10.03.1G1 software system, titled MCS V.10, 1.X Windows.

The MCS V.10, 1.X Windows software enhances the operator interface to make MCS more user-friendly. Soldiers will be able to move through the software and access a number of system applications and functions while staying in their current application. Under MCS V.10.03.1G1, a soldier has to exit MCS to access another application. While out of MCS, new messages sent to the station are not received. The V.10 1.X Windows software allows soldiers to execute these functions from their current application.

Other advantages of the MCS V.10 1.X Windows software include the capability to support additional C<sup>2</sup> functions (such as the terrain evaluation module, OPORD (operation order) and B-C<sup>2</sup> (battalion and below C<sup>2</sup>) software applications, an MSE packet switch capability providing increased Army Tactical Command and Control System (ATCCS) interoperability, the capability to operate on all current common hardware software 1 and NDI hardware, and a minimum training impact to learn the MCS V.10 1.X Windows software (estimated at only 4 to 8 hours for an operator already trained on MCS V.10.03.1G1).

*continued on page 74*

US Atlantic Command and Somalia:

# A New Mission Focus

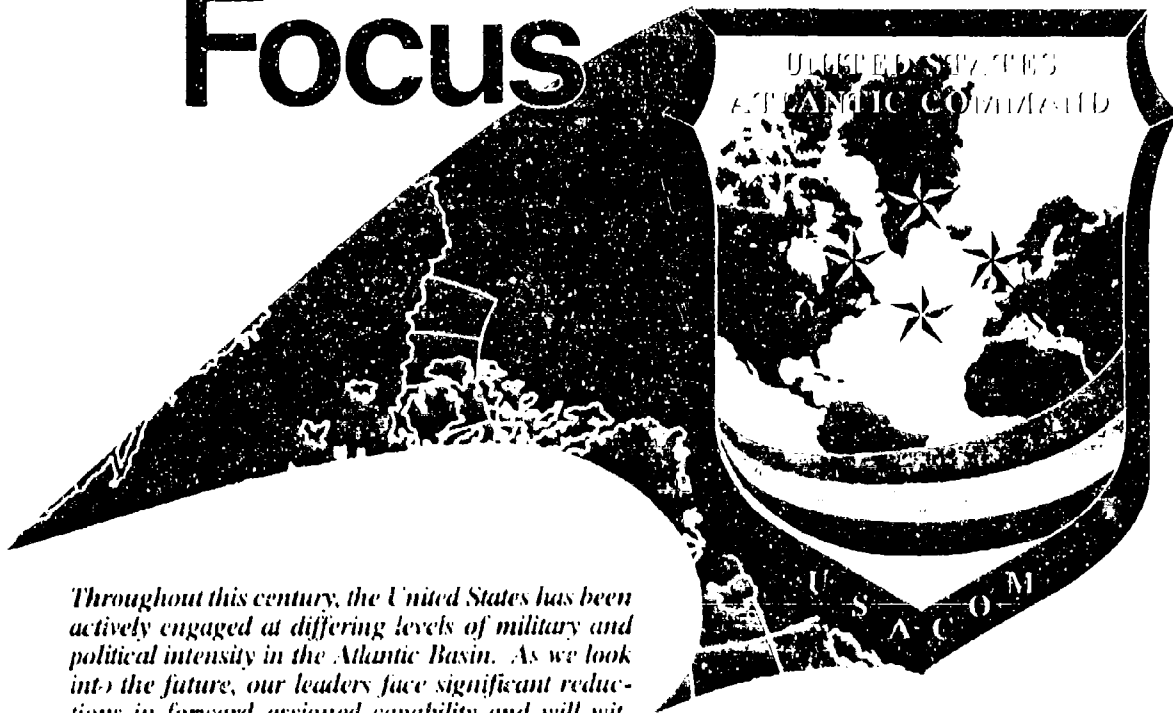

*Throughout this century, the United States has been actively engaged at differing levels of military and political intensity in the Atlantic Basin. As we look into the future, our leaders face significant reductions in forward-assigned capability and will witness continuing shifts in mission focus as regional orientation accounts for a much broader range of conflicts and crises in this vital area of concern. The Military Review proudly shares the strategic and operational vision of Admiral Paul David Miller, commander in chief of the US Atlantic Command, as he describes USACOM's orientation for the future and how it will support US combatant commanders throughout the region. This issue also addresses the changing world situation and how the UN has established itself as the international forum for resolving conflict through consensus. Since 1988, the UN's 30 peacekeeping operations have employed over 60,000 soldiers under its direct command throughout the world. With peacekeeping missions on the rise, Operation Restore Hope in Somalia presented significant operational and humanitarian lessons for UN peacekeepers. In closing out this month's regional focus, two articles address the "business" side of the Somalian humanitarian support operation, discussing rules of engagement, use of nonlethal force and other valuable lessons learned from actual ground operations in the beleaguered South African nation.*



# US Atlantic Command: Focusing on the FUTURE

Admiral Paul David Miller, US Navy

**M**OST READERS have followed and will draw their own conclusions about the collapse of global order that emerged from the destruction wrought by World War II. Rather than an easily identified, singular threat, we now find a dispersal of dangers that require wider, varying coalitions to deter aggression and resolve conflict. Likewise, the halcyon days of expanding defense budgets and steady force levels have been replaced by an uncertain era of budget cuts and force reductions. Our military posture of the past, consisting of a substantial and permanent forward presence, significant in theater capability and massive reinforcement flow from the Continental United States (CONUS), focused on a singular threat, is over.

In the next decade, combatant commanders will face reductions in forward assigned capability and witness a continuing shift in mission focus to regional orientation and a much broader range of conflicts and crises. For example, US European Command (USEUCOM) has been deactivating or returning to CONUS an Army corps and several Air Force wings while still conducting operations in northern Iraq, Bosnia and Macedonia. The strategic landscape has irreversibly and dramatically changed.

Against this backdrop, how do we in the military adjust and respond to dramatic changes in the national security environment? Clearly, we must define our goals and establish just what it is we want to accomplish within the limits of the

---

*Adaptive joint force packaging will improve the efficiency and timeliness of support to combatant commanders by tailoring forces to meet specific mission requirements, thereby reducing duplication of capability and deployment of unneeded forces. By concentrating on capabilities rather than traditional relationships with specific units, the same units and forces will not be identified for all contingencies.*

---

resources available. With the Cold War relegated to the history books, our national military strategy is being directed toward regional issues and peace operations. While these may be unilateral, multilateral or coalition operations, there is one common element—all future US military operations will be multi-service efforts.

As we reshape and downsize our military for the future, we have a central goal of continuing to support our commanders in the field—and our men and women in uniform—with the full range of capabilities necessary to do their jobs in peace, crisis or, if necessary, war. The reference to *capabilities*—not numbers of ships, squadrons or battalions—becomes a crucial change not only as lexicon, but more important, as a new way of thinking. Over the years Americans have not bought and paid for a force designed



solely to defeat the Soviet Union . . . let alone Iraq. Instead, they have purchased definable capabilities that span the entire spectrum of conflict with tools to accomplish the mission—wherever, whenever and however they are needed. The American people have bought and

---

*The halcyon days of expanding defense budgets and steady force levels have been replaced by an uncertain era of budget cuts and force reductions. . . . In the next decade, combatant commanders will face reductions in forward-assigned capability and witness a continuing shift in mission focus to regional orientation and a much broader range of conflicts and crises.*

---

paid for the finest Armed Forces this nation has ever had—the finest in the world today. We must maintain the broad defense capability needed for major regional contingencies, but maintaining that capability while deploying effective force packages for peacetime presence and contingency response in regional operations are two separate and distinct issues.

As we plot our changed course, we are proceeding with caution, determining where our interests lie, assessing commitments and defining our goals within the limits of the resources available to us. We are formulating a coherent military strategy that is based on new security requirements. These requirements are changing the standard deployment cycles and force arrangements of the past 40 years because we now seek to reduce insecurity springing from regional threats by providing a stabilizing influence in these regions.

In accommodating these changes, our readiness is likely to be measured by our ability to package and employ needed capabilities across the full range of defined operations wherever and whenever they are required. Indicators of joint readiness may include the speed with which we deploy and employ our forces, their

mobility once employed, the flexibility and adaptability of the force to changing situations, and our ability to synchronize joint operations across a full range of possible operations in war or operations other than war.

## Origins

President Bill Clinton signed a new Unified Command Plan on 24 September 1993, as recommended by General Colin L. Powell, former chairman of the Joint Chiefs of Staff (CJCS), in the February 1993 "Report on the Roles, Missions and Functions of the Armed Forces of the United States." This plan included one of the most significant changes to the operational support structure of the US military in the last 45 years. It established a single unified command responsible for the joint integration, training and readiness of a majority of the combat forces based in CONUS and assigned this responsibility to the commander in chief, US Atlantic Command (CINCUSACOM). To accomplish this mission, the plan assigned combatant command of the Air Combat Command, Army Forces Command, Marine Corps Forces Atlantic and Navy Atlantic Fleet to USACOM.

## Mission

On 1 October 1993, the CINCUSACOM assumed a new mission while retaining combatant commander responsibilities within his assigned area of responsibility (AOR) and simultaneously serving as Supreme Allied Commander Atlantic. The new USACOM mission:

"Provide military forces where needed throughout the world, and ensure those forces are trained as joint units capable of carrying out their assigned tasks."

This new mission requires:

- Developing, training and facilitating deployment of force packages in support of peacetime presence, contingency response, peacekeeping or humanitarian assistance operations.
- Developing a joint training program for and providing military support to civilian authorities and military assistance for civil disturbances within the 48 contiguous states, the District of Columbia and the geographic AOR.

### Capabilities Cube

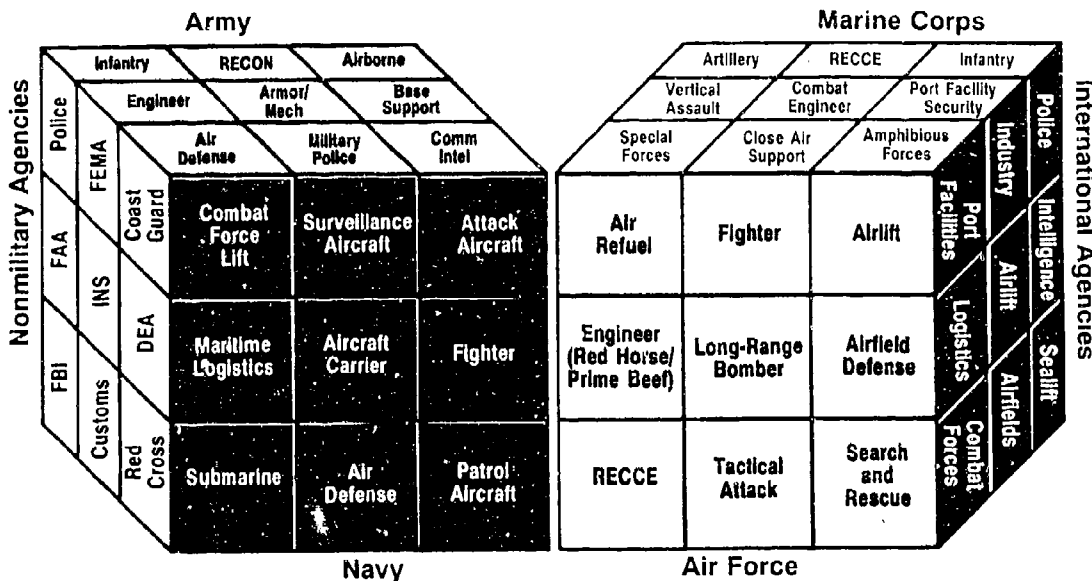

Figure 1

- Planning for the land defense of CONUS and combined Canada–United States defense of Canada.
- Providing forces for worldwide strategic and theater reconnaissance.
- Planning for and conducting counterdrug operations in support of US law enforcement agencies.
- Assuming increased responsibilities in the development of joint doctrine.

#### Packaging

We at USACOM have embraced a meaningful phrase, Adaptive Joint Force Package (AJFP), which we define as: *a capabilities centered grouping of forces and headquarters organized and trained to meet specific peacetime, crisis or wartime requirements of the supported combatant commander.*

One of the new responsibilities requiring the most energy and clarity is joint force packaging and providing those packages to the other combatant CINCs throughout the world. AJFP is one of the mechanisms by which USACOM will provide capabilities-based forces to the unified commanders.

*We hope to establish a joint training simulation center that will allow us to train senior staffs and leverage advanced technology to conduct realistic joint exercises to better define the makeup of the military after next.*

When discussing AJFP, it is useful to illustrate the concept. A Rubik's cube–like square serves as the perfect conceptual model. The cube is a brain teaser testing one's ability to correctly align the six colors of the cube. However, it can also be arranged into many different patterns. In joint force packaging, the six sides of the cube are modified to represent a range of capabilities that exist in the Air Force, Army, Marine Corps, Navy and nonmilitary and international agencies. In this manner, a capability cube is created (see fig. 1).

By rotating the sides of a capability cube, USACOM and its components can assemble a joint force package from a wide variety of assigned forces and capabilities, thereby tailoring the package to respond to the supported

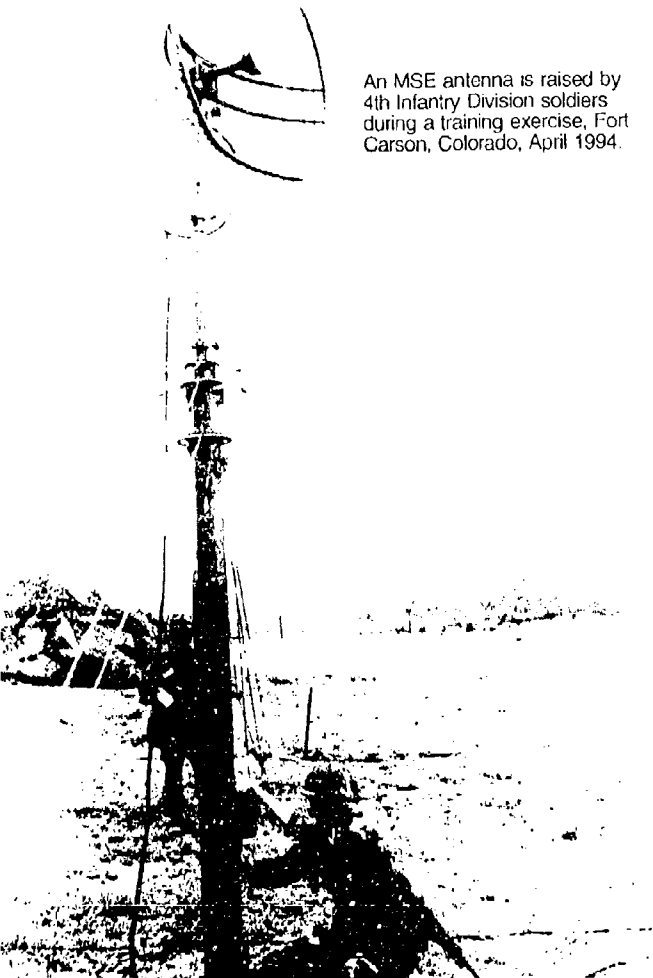

An MSE antenna is raised by 4th Infantry Division soldiers during a training exercise, Fort Carson, Colorado, April 1994.

***Over the years Americans have not bought and paid for a force designed solely to defeat the Soviet Union . . . let alone Iraq. Instead, they have purchased definable capabilities that span the entire spectrum of conflict with tools to accomplish the mission—wherever, whenever and however they are needed.***

CINC's specific mission requirements. The rules for the capability cube allow for different force package alignments. A *correct* answer for a capability cube—unlike its Rubik counterpart—is aligning a pattern whose combined and integrated capabilities can successfully accomplish an assigned mission. There is no single correct configuration because real world dynamics preclude a fixed prescription.

The concept of mixing force capabilities is not new. US Armed Forces routinely use the concept behind adaptive joint force packaging when organizing for combat within each service.

For example, Army commanders task-organize combat arms, combat support and combat service support resources to conduct a specific mission and then change this task organization to accomplish subsequent missions within the same operations plan. Their ultimate objective is to achieve greater collective capability than the individual pieces can accomplish on their own. AJFP modifies this concept to the joint environment (see fig. 2).

For instance, a joint deployment package designed to support a *forward-presence* mission could call for a specific mix of Army capabilities. These capabilities may include noncombatant evacuation capabilities found in aviation units and special operations forces or "show of force" capabilities inherent to maneuver battalions or brigades. A *combined forward-presence* mission would include not only US military capabilities, but allied forces as well. When *peace operations* are the mission, the mix of capabilities could be quite different. Army capabilities could include training of national police forces and providing interim security. The Army's logistics capabilities may be required to rebuild or develop infrastructure, as was the case in Kuwait and Somalia. Some of these capabilities may require employment of National Guard or Reserve forces. In a *theater contingency* package, the combat capabilities of an Army division could complement the war-fighting capabilities of the Air Force, Marine Corps and Navy.

Crucial to building an effective AJFP is the supported CINC's identification of mission requirements. In this manner, force packages are designed to meet the missions of the unified command based on detailed mission analysis and the planning process. They are not a collection of force modules that can be plugged into any contingency operation or crisis.

## Process

The joint force package development process (see fig. 3) starts with the supported CINC. He writes the prescription, articulates the requirement, specifies the need and lays out the sequencing in which he will use those capabilities to conduct specific missions. He forwards his

### Force Package Options

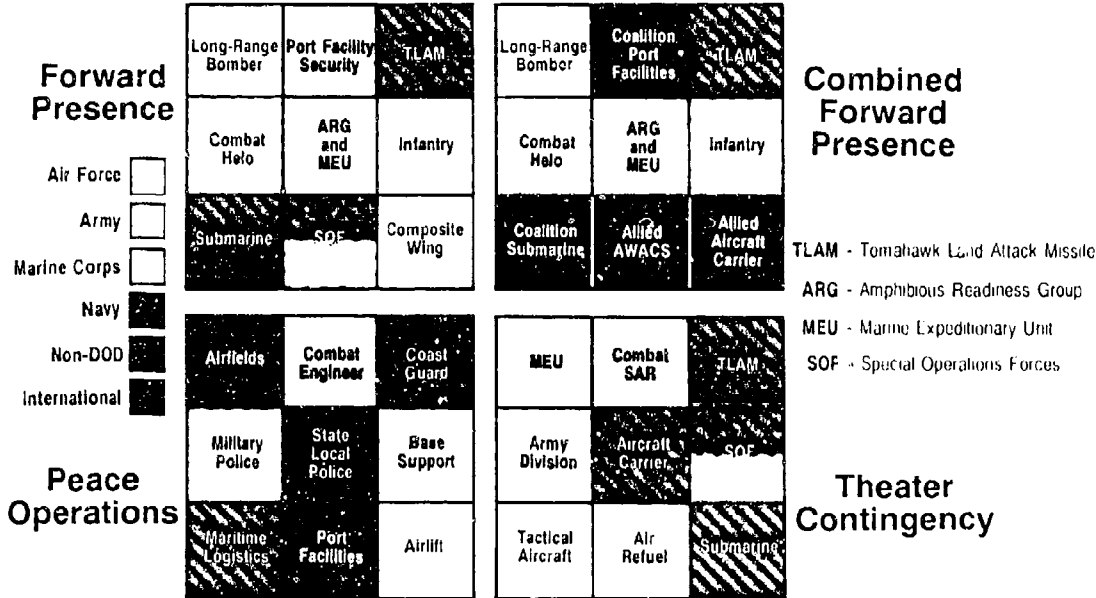

Figure 2

requirements to the secretary of defense (SECDEF) through the CJCS and, often concurrently, to USACOM. The SECDEF, through the CJCS, validates the requirement and directs USACOM to develop a joint force package. After tasking component commands to nominate appropriate forces to support the requirement, the CINC-USACOM assembles a force package from the most capable and ready forces nominated. The resulting package could be one of two types—a preplanned package based on a menu of capabilities designed cooperatively with all warfighting CINCs to respond to the most likely operational scenarios; or a crisis response package built from scratch. In either case, the CINCUSACOM proposes an AJFP to the supported CINC. The two staffs cooperatively refine the package until it satisfies mission requirements. After approval by the supported CINC and the CINCUSACOM, the final package is submitted to the SECDEF through the CJCS for validation. The National Command Authorities direct deployment of the AJFP through the CJCS.

The relationship between the supported CINC and the supporting CINC has not changed; *it's*

*just as it has always been.* What has changed is the supporting CINC now controls a larger array of forces and a much broader spectrum of capabilities to provide the supported CINC the forces he needs to satisfy mission requirements. The supporting CINC has the added responsibility of ensuring that those forces are trained as joint units capable of working together upon arrival in theater.

### Joint Training

Although the National Security Act of 1947 and subsequent legislation codified the "jointness" of our Armed Forces, execution has fallen

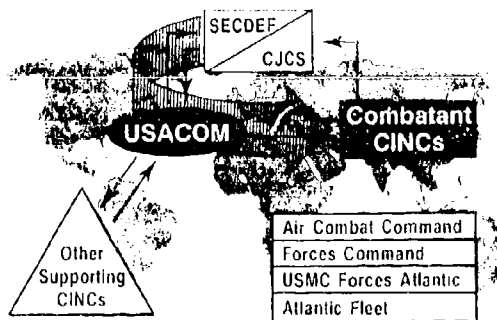

Figure 3. Joint Force Packaging Process

***The concept of mixing force capabilities is not new. US Armed Forces routinely use the concept behind adaptive joint force packaging when organizing for combat within each service. . . . Their ultimate objective is to achieve greater collective capability than the individual pieces can accomplish on their own. AJFP modifies this concept to the joint environment.***

short of extracting optimal use of our joint capabilities. Even Operation *Desert Storm*, a very successful operation and a hallmark of joint and coalition warfare, was fought with control measures separating air and ground operations along service boundaries. Some component commanders met their counterparts for the first time when they arrived in theater. Nor were the capabilities that each service brings to the table thoroughly understood by all decision makers. USACOM will take us another step in the evolutionary journey toward utilizing the nation's complete kit of capabilities by getting us into the joint mode on a daily basis. USACOM can package forces and train them jointly while providing them to the combatant commander in the manner in which they will be employed. Through standardization of training and common understanding of doctrine, we can find "commonality" in an array of different procedures. By resolving differences and developing common solutions to deficiencies from the lowest to the highest echelons, we can establish a common experience base. By accomplishing this in training, we avoid sorting it out once we deploy.

To accomplish this objective, the USACOM joint training concept consists of three tiers (see fig. 4). Tier one is service basic training—those things that soldiers, sailors, airmen and Marines must do to attain their basic core competencies. It involves conducting battalion- and brigade-level operations, performing shipboard and battle group operations and conducting squadron operations. This tier of training includes the Army's basic and advanced individual training,

the noncommissioned officer education system and officer basic and advanced courses. Field training and combat training center rotations will hone the warfighting skills of Army units. The Army and the other services do a tremendous job in this training. It is at the second level of training that we see an opportunity to pull together the training of the Air Force, Army, Marine Corps and Navy.

Tier two is joint and field training. This is where we see an opportunity to bring the services together—in the field—to practice the skills they must perform jointly on the ground, in the air or at sea. We must take every opportunity to train jointly on mission-essential tasks—those tasks or capabilities which the geographic CINC's have determined to be mission essential for their AORs. This means that Army units can request USACOM's assistance in providing training opportunities for performing mission-essential tasks in a joint environment. Training events can be selected by individual units and could include joint enhancements to a battle command training program rotation. Prior to training, we can place a spotlight on exactly what each unit needs to accomplish during a forthcoming exercise or training event.

Tier three training is aimed exclusively at commanders and staffs. It will be conducted in a computer-driven, simulated wargame environment. We hope to create the conditions that will allow us to link field training exercises with simulations. We also hope to train joint staffs less expensively, more responsively and more accurately to meet the requirements of a particular CINC. The ultimate goal is to train the XVIII

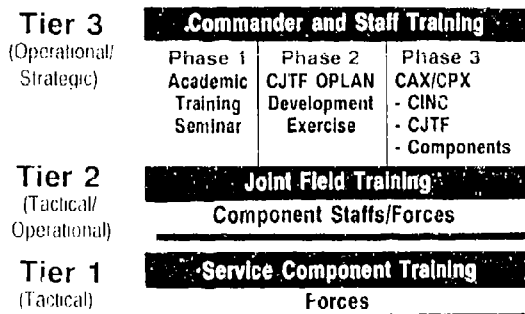

Figure 4. Joint Training Program

Airborne Corps, III Corps, 2d Marine Expeditionary Force and 2d Fleet as a joint task force headquarters. Training will consist of an academic phase to teach joint issues, a joint planning phase and an execution phase.

We are just beginning to scratch the surface in the simulated joint training arena. By the year 2000, we will distribute wargaming and virtual simulation capability to our forces all over the world. We hope to establish a joint training simulation center that will allow us to train senior staffs and leverage advanced technology to conduct realistic joint exercises to better define the makeup of the military after next.

If we can generate a spirit of jointness, a willingness to work together, a comfort of association, a reciprocal value for the goodness of one another's capabilities and services in peacetime, we will not have to do that once deployed.

### The Way Ahead

What we did on 1 October 1993 was install a rheostat, so that over the next months and years, we will be able to turn up to "full bright" the joint training and the joint employment of this nation's military capability.

We believe this new approach is best to ensure that our CONUS-based combat forces are trained and ready to support the broad range of conflicts and crises facing our unified commanders and to meet the challenges of our new regional military strategy. Adaptive joint force packaging will improve the efficiency and timeliness of support to combatant commanders by tailoring forces to meet specific mission requirements, thereby reducing duplication of capability and deployment of unneeded forces. By concentrating capabilities rather than traditional relationships with specific units, the same units and

***USACOM [is] getting us into the joint mode on a daily basis. USACOM can package forces and train them jointly while providing them to the combatant commander in the manner in which they will be employed. Through standardization of training and common understanding of doctrine, we can find "commonality" in an array of different procedures.***

forces will not be identified for all contingencies.

Our approach concentrates on establishing common joint training and standards to improve the responsiveness of our crisis response forces and the overall effectiveness and efficiency of forces in joint operations worldwide. This joint training program, combined with a coordinated exercise scheduling system, will improve efficiency, reduce cost, increase the overall readiness of US forces and foster greater service interoperability. We want to add as much value as we possibly can at the joint level to allow us to bring the forces together, train them jointly and provide them to the supported CINCs at the best possible state of preparedness.

USACOM's goal is to realize the full potential of America's Armed Forces in a resource-efficient and operationally effective manner, because we know well that in the future America will have less military, but we won't need our military any less.

What do soldiers, sailors, airmen and Marines need to know about USACOM? Each must know about its responsibilities and its missions as it impacts the future. They need to have an appreciation for its origin. That is what USACOM is all about, the future. **MR**

*Admiral Paul David Miller, US Navy, is the supreme allied commander-Atlantic and commander in chief, US Atlantic Command, Norfolk, Virginia. An Officer Candidate School graduate, he received a B.S. from Florida State University and an M.A. from the University of Georgia. He is a graduate of the Naval War College and Harvard Business School Executive Management Program. He has served in a variety of command and staff positions in joint and allied assignments in the Continental United States, the Atlantic and Pacific fleets, including executive assistant to the commander in chief, Pacific-Hawaii; executive assistant to the Secretary of the Navy, Washington, D.C.; commander of the US Seventh Fleet-Japan; deputy chief of Naval Operations (Naval Warfare), Washington, D.C.; and commander in chief, US Atlantic Fleet, Norfolk, Virginia.*

# A Changing World, A Changing UN

Jan Goldman

**E**ARLIER THIS DECADE East and West Germany united to form one country, while Yugoslavia and the Soviet Union fragmented into more than a dozen sovereign nations. Meanwhile, the UN, a product of the post-World War II era, struggles in search of an identity and role during uneasy times. As the world rapidly approaches the 21st century, the effects of World War II, which ended almost 50 years ago, are finally being played out.

The UN charter was founded and designed largely as a mechanism for dealing with conflict between states. Increasingly, the prevailing view today is that the UN is seen as a world policeman. The ideals of the UN and the subject of an international military force are again resurfacing as an issue in the post-Cold War years.

Long the scene of bitter exchanges between the United States and the Soviet Union, and often the focus of heated criticism for its inefficiency and waste, the 180-member body is enjoying a quiet revival.

"The Cold War was probably the major impediment to a realization of the UN as people thought about it in 1944-1945," says Donald E. McHenry, US ambassador to the UN during the Carter administration. When the organization was founded, he says, people believed that countries would cooperate in peace as they had cooperated in war. "Of course, they did not. They immediately started fighting. Now, with the Cold War practically over and countries having exhausted themselves in regional conflicts, there is once again a useful role for the UN to get people out of the problems they are in."<sup>1</sup>

But before the UN can even think of using military force, it must have a clear mandate among its members that military force is a viable and attainable option.

## International Forces of the Past

International forces have been defined in several ways. However, the world community has had little experience sustaining such forces. Multinational forces, integrated to the squad of foot soldiers or the crew of sailors, have sometimes given effective performances as military units. "Englishmen will not forget that Admiral [Horatio] Nelson's own flagship at the Battle of Trafalgar was crewed by Englishmen, Scotsmen, Irishmen, Welshmen and various islanders, and the 22 Americans, seven Dutchmen, six Swedes, three Frenchmen, two Danes, three Norwegians, one Russian, three Germans, four Italians, two Indians, one African, nine West Indians and four Maltese."<sup>2</sup>

Some would see the collective use of national power to suppress threats to the status quo of 1815 as an analogy to the world today. The six-nation international force that went to Peking for the Boxer Rebellion on 14 August 1900 included several non-Western participants as well as Japanese.

In modern times the first hint of an international force in this country came in 1910 when the US Congress suggested creating a commission to study "constituting the combined navies of the world into an international force for the preservation of universal peace" in connection with arms limitation.<sup>3</sup>

President Theodore Roosevelt told Congress, "Chronic wrongdoing, or an impotence which results in a general lessening of the ties of civilized society, may in America, as elsewhere ultimately require intervention by some civilized nation and in the Western Hemisphere the adherence of the United States, however reluctantly, in flagrant cases of such wrongdoing or impotence, to the exercise of an international police power."<sup>4</sup>

The closest thing to a genuine international force before the UN era was the 3,300 man, four-nation force set up by the League of Nations to supervise the 1934 Saar Plebiscite.<sup>5</sup> Previous UN forces were usually recruited from smaller, weaker nations due to the competitive and paranoid nature of the two superpowers. During the Cold War, these troops were not only the best obtainable under the circumstances, but a potentially indispensable addition to the peacekeeping function. As of 1993, 72 countries were contributing soldiers to more than a dozen UN peacekeeping missions around the globe.

Examples include the 150-member UN truce team that observed the Palestine War armistice. Twenty-nine countries offered troops to the UN forces in the Congo. At a peak strength of 19,000 or more in early 1963, these forces contained elements from 10 countries plus supporting personnel from 10 others. The UN Security Force in West New Guinea in 1962 consisted of 1,500 Pakistani ground forces and a small US and Canadian air and sea support component. Additionally, 200 observers served in Yemen in 1963. "The United Nations can do great things, a vital forum where the nations of the world seek to replace conflict with consensus," said President George Bush in an address before the UN General Assembly.<sup>6</sup>

In the early 1950s, the organization's image and credibility suffered from McCarthyism when it became the focus of US congressional scrutiny as a potential hotbed of communism. At the same time, American attitudes toward the UN were adversely affected by the organization's inability to prevent or stop the Korean War on 25 June 1950.

### New Style for a New Environment

The nonconfrontational style of the UN peacekeepers was arguably appropriate to the Cold War environment, especially since UN troops—better known as "blue helmets" or "blue berets"—won the Nobel Peace Prize in 1988. Their work followed a pattern during these years

---

*"With the Cold War practically over and countries having exhausted themselves in regional conflicts, there is once again a useful role for the UN to get people out of the problems they are in." But before the UN can even think of using military force, it must have a clear mandate among its members that military force is a viable and attainable option.*

---

that consisted of peacekeepers who patrolled cease-fire lines after a truce pending the signing of peace treaties. However, it seemed these treaties never got signed, making the assignments endless. For example, Cyprus, where UN troops stood between the Turks and Greeks, and the Golan Heights, where the UN stood between the Israelis and the Syrians, may be considered paragons of perpetual UN peacekeeping roles. These types of UN missions could take place only when the United States and the Soviet Union agreed to let them work. No peacekeepers were ever dispatched to Vietnam or Afghanistan.

Past UN operations worked best when their troops, armed only for self-defense, served as impartial referees between the belligerents. The blue helmets actually used force to end the Katanga secession in the Congo in the early 1960s, but only by changing their tactics from defensive to offensive. The offensive mounted assaults on Elisabethville, including aerial bombing. However, this provoked so much anger in Europe and in conservative circles within the United States that it was never tried again and is barely mentioned in UN rhetoric.



---

*In modern times the first hint of an international force in this country came in 1910 when the US Congress suggested creating a commission to study "constituting the combined navies of the world into an international force for the preservation of universal peace" in connection with arms limitation.*

---

Katanga aside, UN officials usually insist that peacekeeping troops never be used as an offensive force.

### Changing Times

Following the end of the Cold War, the demands for peacekeepers accelerated. By 1988, in its first 43 years, the UN had mounted 13 peacekeeping operations. Between 1988 and 1993, the UN authorized another 15 peacekeeping operations. By 1993, sources estimated there were over 60,000 soldiers under direct UN command throughout the world.<sup>7</sup>

For the most part, the UN has found itself with a new role in an era when the good relations between the United States and the republics of the former Soviet Union have allowed many insurrections and firestorms to simmer down. Instead of patrolling cease-fire lines, UN troops are now more likely to find themselves supervising the steps toward normality and elections in a ravaged country after, rather than before, the signing of a peace treaty by the belligerents in a civil war. For example, in Cambodia, the UN is serving as a quasi-colonial power. As Prince Norodom Sihanouk explained when he addressed several American visitors in a northern Cambodian village, "Before, we were a protectorate of France, but we had only one master. Now, we are again a protectorate. The difference is that we now have many patrons, many masters."<sup>8</sup> The 22,000 troops belonging to the UN Transitional Authority in Cambodia built a facility unique to their mission—a new \$87,000 prison.

New operations are often highly charged politically, which raises questions of whether UN officials, inexperienced in wielding political

power and UN troops unaccustomed to using force are right for the job. According to press reports, some observers believe that Yasushi Akashi of Japan, the veteran UN bureaucrat who heads the peacekeeping operations in Cambodia, gives in too easily to the machinations of Sihanouk. When asked whether he had the power to prevent Sihanouk's plan to win election as president even before a constituent assembly meets to write a constitution, Akashi replied, "I don't know. But assuming I have that power, I don't believe I would be politically able to prevent it."<sup>9</sup>

In Angola, a UN peacekeeping force of 900 soldiers and civilians was simply too weak to prevent Jonas Savimbi's troops from taking up arms again after his party lost elections. Human rights groups insist that the UN mission in El Salvador has tried so hard to avoid offending President Alfredo Cristiani that it has failed to adequately publicize the incessant violation of the rights of civilians there.

Inspired initially by its charter "to save succeeding generations from the scourge of war which twice in our lifetime has brought untold sorrow to mankind," the UN now has a mandate that extends beyond security. It still will need to deal with regional conflicts, even if the threat of another world war lessens as the Cold War menace dissipates.

Of course there are numerous other challenging problems that await the kind of international solutions only a multilateral organization such as the UN can produce. Environmental pollution, terrorism, drug trafficking and widespread epidemics such as AIDS are examples of problems that no government or regional body of governments can be expected to handle on its own.

### Intention Versus Reality

UN forces have been described as a form of third-party intervention involving "any action taken by an actor that is not a direct party to the crisis, that is designed to reduce or remove one or more of the problems of the bargaining relationship and therefore, to facilitate the termination of the crisis itself."<sup>10</sup>



A UN observer from Uruguay records a complaint from an Indian officer during the Kashmir dispute, 1955. The modest UN-led deployments to Palestine and Kashmir during the organization's first decade have recently been dwarfed by 22,000- and 38,000-man operations in Cambodia and the former Yugoslavia. The UN force of roughly 45,000 US and multinational troops in Somalia was US-led during the period that American troops were on hand.

*By 1988, in its first 43 years, the UN had mounted 13 peacekeeping operations. Between 1988 and 1993, the UN authorized another 15 peacekeeping operations. By 1993, sources estimated there were over 60,000 soldiers under direct UN command throughout the world.*

The institutional sources of third-party intervention, on which the UN bases its justification in international relations, are varied from the international community at one end of the spectrum to less-developed world powers at the other end. Similarly, the nature of third-party involvement ranges from continuing peace talks to field operations. The use of emergency military forces to interpose or monitor compliance with an agreement is considered by some diplomats as the highest form of field operations for a multinational force.

In some cases though, third-party intervention may involve the use or threat of military force to go beyond facilitating the ending of a crisis and actually attempt the enforcement of an externally determined solution. This form of UN intervention was carried out multilaterally in Kuwait, Korea and the Congo; by the United

States and some Caribbean states in Grenada; and in altogether different circumstances by the former Soviet Union and East European states in Czechoslovakia and Hungary.

In attempting to systematically approach the problem of international forces, one faces an extraordinarily varied range of greater-than-national forces and their possible missions. If, for the sake of analysis, one accepts the concept of a continuum, without necessarily believing that one level will automatically lead to the next, the scale includes significant intermediate levels of possible missions. These actions may include peacekeeping operations that entail watching for border violations between two countries or peace enforcement operations which could result in physical coercion.

Peacekeeping can best be described as a mission assigned to a military force that is not in the

business of threatening or using weapons except for self-defense. The nonthreatening nature of peacekeepers is closely connected with their value of impartiality. Given that they are neither

---

*New operations are often highly charged politically, which raises questions of whether UN officials inexperienced in wielding political power and UN troops unaccustomed to using force are right for the job. . . . When asked whether he had the power to prevent Sihanouk's plan to win election as president even before a constituent assembly meets to write a constitution, Akashi [who headed UN peacekeeping operations in Cambodia] replied, "I don't know. But assuming I have that power, I don't believe I would be politically able to prevent it."*

---

empowered nor equipped to enforce a solution, they are trusted by both sides and therefore can only behave with complete impartiality. The UN Emergency Force officially brought the term *peacekeeping* into being to differentiate between previous UN enforcement of collective measures.

However, if at any time a peacekeeping force abandons its nonthreatening posture, it will become a more significant party to the dispute in question and likely fall into a peace enforcement role. Thus, a peacekeeping force is responsible for maintaining law and order and not influencing the balance of domestic controversy. Peacekeeping proved to be the most direct contribution to the maintenance of peace, which, as previously noted, won the UN the 1988 Nobel Peace Prize. Indeed, peacekeeping can be seen as little more than a modern application of an ancient arrangement—that of the use of impartial and nonthreatening go-betweens. Perhaps, given the political noncompetitive world climate today, the enlistment of additional peacekeeping forces will be encouraged.

The UN charter came into force on 24 October 1945. Today, after subsequent amendments, the

charter includes 19 chapters and 111 articles. Nevertheless, it is Chapter VII, "Action with Respect to Threats to the Peace, Breaches of the Peace, and Acts of Aggression" that spells out UN rights for establishing a military force.

Chapter VII provides a framework for action and details how the organization's founders intended a multinational force to operate as the world policeman, given specific parameters established during the Cold War era. In the sections surrounding Chapter VII, the founders go to great lengths to outline the "pacific settlement of disputes" and the possible "regional arrangements" appropriate to the Security Council before a military unit can be used to settle a dispute.

According to Chapter VIII, "Nothing in the present Charter precludes the existence of regional arrangements or agencies for dealing with such matters relating to the maintenance of international peace and security as are appropriate for regional action . . ."<sup>11</sup>

Additionally, UN intentions to use military forces expediently in the past have been bogged down by the bureaucratic diffusion of power over its troops in the form of the UN Military Staff Committee. This committee was established under Article 47(1) of the charter "to advise and assist the Security Council on all questions relating to the Security Council's military requirements for the maintenance of international peace and security, the employment and command of forces placed at its disposal . . ." Article 47(2) stipulates that the staff committee "shall consist of the Chiefs of Staff of the permanent members of the Security Council or their representative." Further provision is made of the co-optation of any member of the UN "when the efficient discharge of the committee's responsibilities requires the participation of that member in its work."

As a consequence of the Cold War, the committee has been, for all practical purposes, considered inactive, meeting monthly in New York. With the recent transformation in superpower relations insofar as they have ended the "reciprocal veto" behavior of the United States and the former Soviet Union, the opportunity exists to

German naval and ground forces at the port area of Mogadishu, Somalia, 1993.

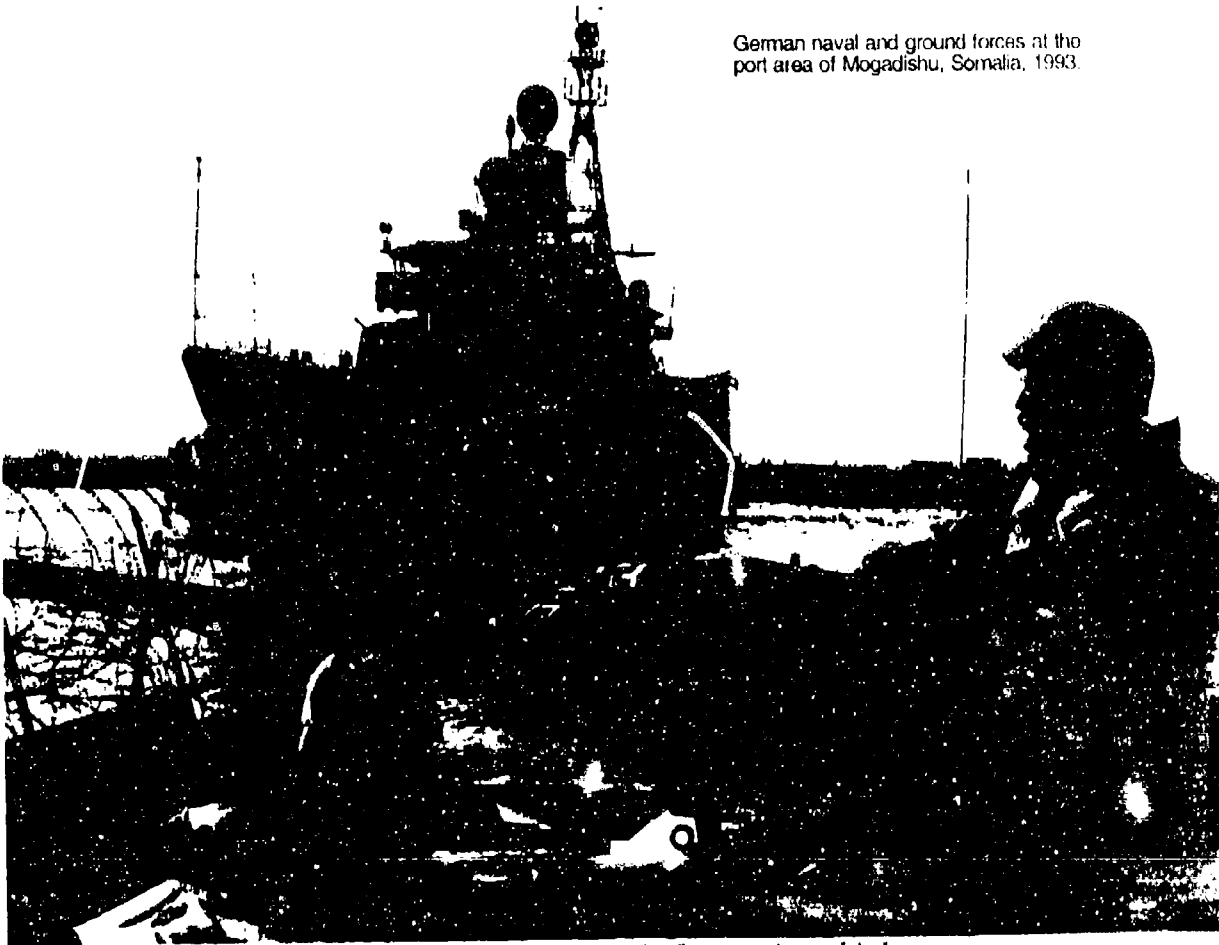

*Without a doubt, the UN faces an uncertain future. As a third party to the superpower rivalry for almost 50 years, the organization will increasingly be called upon for moral leadership and authority. In the past, Cold War paralysis prevented the UN from creating any force other than peacekeeping; however . . . [the Somalia] mission, considered both peacekeeping and peace enforcement, exemplified the growing aspirations of the organization.*

replace or instill a substantive military staff committee. All of these chapters have allowed members of the Security Council, such as the United States and the former Soviet Union, to seek settlement of disputes within their sphere of influence without fear of UN interference. Previously both countries cited regional interests within Latin America and Eastern Europe, respectively. However, it is clear during the past five years—as the Cold War fades into obscurity, that Chapter VII should become the Security Council's overriding concern instead of provisional interests.

On the other hand, facilitated by the virtual unanimity of the Security Council votes on the

Gulf Crisis in August 1990—votes which certainly legitimized the use of force after 15 January 1991—new pathways have opened up. The aim of the Security Council should be to move down these pathways. The Gulf War, which started in August 1990 has, for the first time since the UN charter was adopted in 1945, called attention to many questions pertaining to the rights of a multinational force. However, it is the articles within the charter that offer a framework within which the necessary answers can be constructed. Ultimately, it is the articles that should give the UN a full sweep of power—judicial, moral, economic and military—which was the intent in 1945.

*As a consequence of the Cold War, the [UN Military Staff Committee] has been, for all practical purposes, considered inactive. . . . With the recent transformation in superpower relations insofar as they have ended the "reciprocal veto" behavior of the United States and the former Soviet Union, the opportunity exists to replace or instill a substantive military staff committee.*

## Uncertain Future

Without a doubt, the UN faces an uncertain future. As a third party to the superpower rivalry for almost 50 years, the organization will increasingly be called upon for moral leadership and authority.

In the past, Cold War paralysis prevented the UN from creating any force other than peace-keeping; however, all that is changing. During January and February of 1993, UN troops were used for the first time in Somalia to ensure the security of humanitarian relief personnel and supplies. This mission, considered both peace-keeping and peace enforcement, exemplified the growing aspirations of the organization.

Hence, by its piecemeal approach, the UN mission had elements of both roles as its troops entered the country to assume some of the civic responsibilities of the government. While peace-keeping and peace enforcement operations had

all been previously approved by the Security Council, the Somalia mission was the first non-controversial humanitarian UN troop movement in the post-Cold War era. However, since the mission was first authorized, UN troops in Somalia have been the target of criticism. Government officials have publicly asserted that UN troops are ill equipped and often untrained. Additionally, the mission had expanded from feeding starving people to disarming warring factions. In the past, UN troops commonly performed their duties in a nonconfrontational manner, which received overwhelming support from many smaller nations. In past UN peacekeeping operations, any military unit that included US troops was commanded and staffed by American military officers. Further, in past UN peacekeeping operations in the Persian Gulf and Korea, over 90 percent of all troops were American. However, the United States realizes it cannot assume world leadership alone, and the UN must have the chance to mature and gain the responsibility and respect it deserves.

Article 43 of the UN charter authorizes a standing military force. But to be an effective force, the UN must also take the lead morally. As the former Soviet Union fades militarily from superpower status, the United States can make greater use of multinational forces to support US national interests and fulfill UN objectives. The organization can now truly claim that it acts by consensus and not be a battleground between competing superpowers. **MR**

## NOTES

1. Anthony Greenham, *A Future UN Role* (Bedford Press, 16 January 1992).
2. Lincoln Bloomfield, *International Military Forces* (Boston: Little, Brown, 1984), 4-5.
3. Arthur Larson, *When Nations Disagree: A Handbook on Peace Through Law* (Cornell State University Press, 1961), 290.
4. Bloomfield, 5.
5. *Ibid.*, 6.
6. President George Bush addressed the 44th session of the General Assembly on 25 September 1989.
7. *United Nations: Peacekeeping Operations* (Washington, DC: US Government Printing Office, March 1992).

8. Edward C. Luck, *Making Peace*, *Foreign Policy*, Vol. 89 (Winter 1992-1993), 9-10.
9. *Ibid.*
10. J. Wikenfort and Michael Hirscher, *International Cases 1945-75: The UN Dimension*, *International Studies Quarterly*, Vol. 28, (3 March 1984), 46.
11. The full text of Chapter VIII, Article 52 states: "Nothing in the present Charter precludes the existence of regional arrangements or agencies for dealing with such matters relating to the maintenance of international peace and security as are appropriate for regional action, provided that such arrangements or agencies and their activities are consistent with the Purposes and Principles of the United Nations."

*Jan Goldman is a faculty member at the Joint Military Intelligence College in Washington, D.C. He has also served as an intelligence analyst with the Defense Intelligence Agency at the National Military Joint Intelligence Center (J2), The Pentagon, Washington, D.C.; with 1st Special Operations Command, Fort Bragg, North Carolina; with US Army South Panama; and with Naval Space Surveillance Command at Dahlgren, Virginia.*

# A New Face in NATO

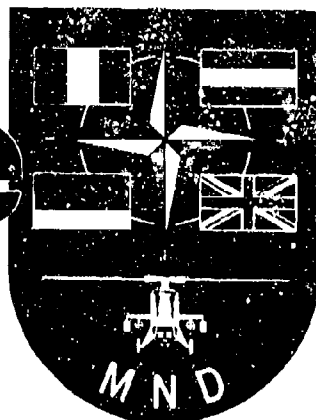

Major General Pieter Huysman, Royal Dutch Army

**T**HE MULTINATIONAL Division (Central) MND(C) is a brand new NATO formation whose headquarters became operational 1 April 1994 at the Rheindahlen Military Complex. Until 1993, this was the headquarters for both the Northern Army Group (NORTHAG) and 2 Allied Tactical Air Force (2ATAF).

Under NATO's new command structure, the MND(C) belongs to the Alliance's Rapid Reaction Forces (RRF) and the Allied Command Europe Rapid Reaction Corps (ARRC), to which the MND(C) answers in peacetime and also in principle in periods of crisis. The ARRC headquarters has been transferred from Bielefeld to Rheindahlen, resulting in the collocation of significant elements of the RRF, which has obvious operational advantages.

This article aims to portray this "new face in NATO" by describing the background and concepts of multinationality and airmobility of the MND(C). Furthermore, it will consider aspects of airmechanization, command and control and leadership.

In the 1980s, while the General Defense Plan was still current, the need was readily apparent that a rapidly and easily deployable airmobile formation must be created. Feasibility studies for such a concept were carried out by the Allied Forces Central Europe (AFCENT) headquarters. These studies were overtaken by political and military developments in 1989; the earlier threat fell away, and NATO initiated the radical reorganization that is still under way.

However, the concept in question was not put on ice. On the contrary, it ideally suited NATO's

changing philosophy, which was being directed more and more at crisis management. To keep the momentum in decision making, one of

---

*NATO's Defense Planning Committee decided in January 1992 to form a standing MNAD consisting of troops from Belgium, Germany, the Netherlands and the United Kingdom, alongside other rapid reaction forces. Its foundation was established by an important political rationale: NATO should have at its disposal an organic multinational formation of relatively small size.*

---

NORTHAG's last exercises, *CERTAIN SHIELD*, was staged in September 1991, using an ad hoc multinational airmobile division (MNAD).

At ministerial level, NATO's Defense Planning Committee decided in January 1992 to form a standing MNAD consisting of troops from Belgium, Germany, the Netherlands and the United Kingdom, alongside other rapid reaction forces.

Its foundation was established by an important political rationale: NATO should have at its disposal an organic multinational formation of relatively small size (20,000 troops). The multinational concept within the division automatically means sharing the political responsibility, if committed to action. Furthermore, this political responsibility may be demonstrated at a relatively low level within NATO. In view of this, an MND(C) activation staff was formed on 1 April

*Multinationality also means that major combat elements, the brigades, have differing structures, armament and logistics. Logistics are a particularly problematic area deserving continued study and resolution. . . . It became apparent that a certain degree of diversity can confer advantages in operational terms. Depending on the mission to be carried out, it may be possible to take advantage of particular national skills and equipment.*

1992 in Brunssum and tasked with bringing this about under the supervision of AFCENT headquarters. This initial staff was restructured and became the MND(C) headquarters.

### Multinationality

Multinationality is nothing new in NATO, whose existence rests on a crucial pillar called the *Alliance*. Thus, all headquarters above army corps level were already multinational in composition, and exercises of the national army corps were conducted among allies and involved the cross posting of units. This might lead to the conclusion that this familiar formula could be applied when forming a multinational division. We maintain, however, that the old circumstances demanded different emphasis on the requirements of the MND to operate

smoothly as a fighting formation.

NATO cannot allow itself to bring into being a merely "political" division. In view of this new politico-military situation in Europe, it is quite clear that this kind of formation may be used as a crisis management tool both within the framework of the ARRC and outside of it. However, we should not be frightened by this challenge. As longstanding military partners, we can and must translate this political will into fact. We have already noticed the spirit and sense of purpose at the MND(C) headquarters and divisional units; they are encouraging. We shall return to this theme when discussing leadership.

To begin with, multinationality has been given form in the MND(C) by means of the division's organization. As for the headquarters element, each participating country supplies 25 percent of the total personnel strength. There are four rotating appointments: the commander (presently Dutch), his deputy (British), the chief of staff (German) and the G3 (Belgian).

The same balanced representation is reflected in the divisional organization. Each country provides one brigade: the Belgian Para-Commando Brigade, the German 31 Luftlandebrigade, the British 24 Armobile Brigade and the Netherlands 11 Airmobile Brigade (see figure). This multinationality also means that major combat elements, the brigades, have differing structures, armament and logistics. Logistics are a particularly problematic area deserving continued study and resolution. During initial map exercises and

### Multinational Division (Central) Organization

- BE - Belgium
- GE - Germany
- NL - Netherlands
- UK - United Kingdom
- NSG - National Support Group
- CSSG - Combat Service Support Group

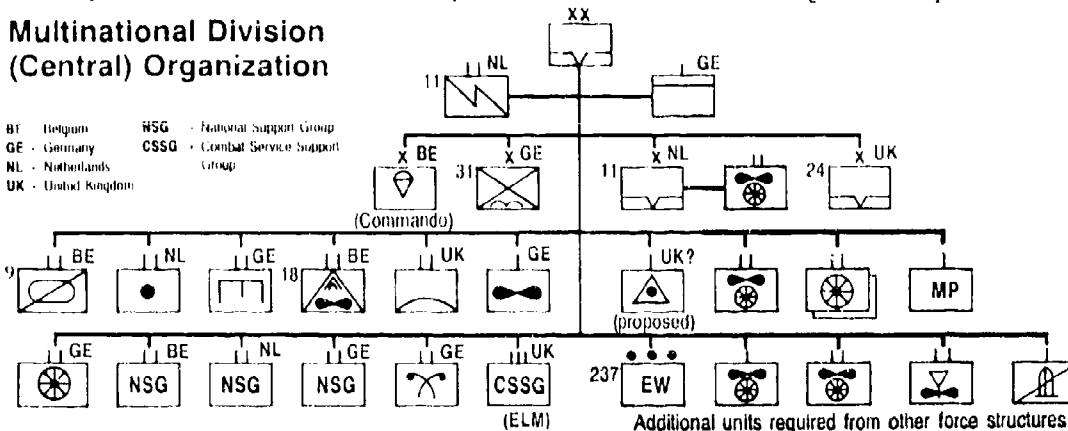

A British Lynx-3 battlefield helicopter armed with the NATO version of the TOW antitank missile.



Ministère de la Défense France

*The strength of the division lies in combining its light infantry with airmobility through the use of transport helicopters to allow fast and flexible intervention for all kinds of missions. The firepower and mobility of today's armed helicopters and future attack helicopters make them the most important warfighting element in combat operations.*

study periods with subordinate commanders, it became apparent that a certain degree of diversity can confer advantages in operational terms. Depending on the mission to be carried out, it may be possible to take advantage of particular national skills and equipment. For example, the Belgian and German brigades have an airlanding capability. Additionally, the German brigade possesses the Wiesel, a light armored vehicle mounting a tube-launched, optically tracked, wire-guided missile or rapid-fire cannon. In the British and Dutch brigades, combat helicopters are a fully integrated element of the organization. In total, the division consists of 11 infantry battalions with significant combat capability.

### Concept

The establishment, training and the eventual missions of a brand-new NATO formation such as the MND(C) requires a clear vision, laid

down in concept and advocated by the contributing countries and NATO. After all, the commander of this formation must know his responsibilities and the operational limits within which he must operate. This concept has been developed by the MND(C) activation staff. It was no simple matter to get the authorities into alignment on all points. Nonetheless, overwhelming agreement and moral support were voiced, laying a good basis for further cooperation.

The concept establishes the roles the MND(C) must fulfill. In order of increasing intensity, it may be called on for disaster relief, humanitarian aid, showing the flag, peacekeeping, embargo enforcement, peace enforcement and actual combat operations. Diverse tasks may arise within these roles, which will require a high degree of flexibility and proficiency among the division's headquarters and assigned forces. Aspects such





Soldat und Technik

missions may be characterized by unpredictability and confusion concerning enemy forces, local cultures or terrain features, a fast and accurate intelligence system is essential. The MND(C) needs the support of higher echelons such as the ARRC.

The strategic deployment of MND(C) units to an area of operations far away from home is a major logistic exercise that requires embarkation, transit, disembarkation, unit assembly at points of debarkation (PODs) and movement control between PODs and the divisional staging area. All of these are national responsibilities, and the transfer of authority takes place only after units have been brought to readiness in the staging area. Nevertheless, the MND(C) headquarters, as the coordinating authority, determines which units should arrive at a given location and in what sequence.

The logistic support of brigade and division troops remains a national responsibility from the moment these troops leave their homeland until their arrival at the front line. Besides the normal organic brigade logistic units, so-called national support groups (NSGs) are set up to provide second- and third-line logistic support. This will remain the same in the interim; in the long run we hope to achieve a certain degree of "role specialization" so that one country takes over one specific logistic area. For example, Country ABC would be responsible for the supply function, while Country XYZ assumes a medical support role. This is certainly more economical and easier to oversee from a command and control standpoint. However, participating nations are not yet at this point. Role specialization concerning materiel maintenance is harder to achieve because of the diversity of helicopter, vehicle and weapon types within the division. For this reason, we envisage a structure involving a "lead nation" at command level and subordinate national logistic detachments servicing their own country's equipment.

### Airmobility

The MND(C) concept foresees the development of an airmobile division whose foremost characteristics are flexibility in deployment options, independence from terrain and obstructions, enough speed to maneuver infantry over

*The reaction times of an airmobile division cannot be expressed with any precision since many variables, such as weather, terrain and distance, need to be taken into account. Without refueling, the helicopters currently available are able to cover round-trip distances of 120 km in a relatively short time. The aim is to extend the airmobile radius to 300 km to enable MND(C) forces to maximize real tactical or operational benefits.*

as intelligence, logistics and command and control will be prerequisites since the location of the area of operations is unknown and it may be necessary to cover large distances in a short time.

Units and means capable of gathering intelligence will need to be dispatched to the area of operations as a matter of priority. Without going into too much detail, intelligence is the processing of information provided by aggressively deployable long-range reconnaissance patrols, conventional reconnaissance units, satellites, drones and electronic warfare units. Since the



Combined units like the one above are representative of the direction that European force structures are likely to take in the future.

*It is of particular importance for the commander to pay attention to the integration of four different military cultures, not just among his staff, but also at unit level in the field. Unencumbered by any traditional ways of thinking, a new and distinctive multinational culture can evolve at MND(C) headquarters and radiate to the division's units.*

long distances and the ability to engage opponents from the air. Moreover, MND(C) ground units are light infantry equipped with a considerable quantity of antitank weapons, light artillery and heavy mortars. With the exception of the Wiesel's weapons carrier, the infantry has no armor and has restricted mobility on the ground.

The strength of the division lies in combining its light infantry with airmobility through the use of transport helicopters to allow fast and flexible intervention for all kinds of missions. The firepower and mobility of today's armed helicopters and future attack helicopters make them the most important warfighting element in combat operations. By taking advantage of the third dimension—the air—it is possible to rapidly create a local and temporary concentration of force. Furthermore, the use of helicopters makes it possible to relieve friendly forces under threat by intervening with a surprise concentration of force from any direction. A current restriction is that not all helicopters have an all-weather capability yet.

Other important roles for armed helicopters are reconnaissance, direction of close air support or

indirect fire and airmobile deployment escorts.

Between now and the year 2000, the available helicopter strength may rise from 147 to 205, which includes transport aircraft, antitank, attack, scout and liaison helicopters. Of course, for peacekeeping and other low-intensity operations, helicopters will mainly be used by the countries providing them for their own forces. However, in the event of combat operations, it may become necessary to create a local main thrust by flying a significant part of a brigade's forces into an area of the combat zone. With this projected helicopter fleet, it will be possible to drop 2,100 combat-ready soldiers at a stroke. Obviously, the number of troops will be less if heavy equipment is also required. The optimum mix will be entirely dictated by the mission. In principle, it should be possible to simultaneously deploy one battalion-size unit per brigade using national airmobile assets.

The reaction times of an airmobile division cannot be expressed with any precision since many variables, such as weather, terrain and distance, need to be taken into account. Without refueling, the helicopters currently available are

able to cover round-trip distances of 120 kilometers (km) in a relatively short time. The aim is to extend the airmobile radius to 300 km to enable MND(C) forces to maximize real tactical or operational benefits. Under new crisis management strategy, such distances can become particularly important in using our forces to deliver a warning without appearing provocative. In other words, the force is kept back at a significant physical distance, but can be moved into position fast if the need arises. In the case of impassable areas or a devastated infrastructure, airmobility is absolutely indispensable, even over short distances.

### **Airmechanization**

Every combat unit should have both an offensive and a defensive capability. Also, this is true of the MND(C), lest its operational value be restricted. The "strike power" of an airmobile division is expressed by the combat effectiveness of its helicopters against ground targets and in air-to-air combat under all weather conditions. This offensive potential is needed to win terrain and to enable progress by ground forces.

A difference should be drawn between the armed helicopter and the attack helicopter. The distinction may be made simply by pointing out that the armed helicopter is a weapon platform, whereas the attack helicopter is a weapon system in its own right, able to absorb greater punishment and possesses both gun and rocket systems with advanced fire control. The attack helicopter is able to undertake so-called air-mechanized operations, in which air-mechanization is described as "the ability to maneuver in, and to fight mainly from, the air against enemy ground forces and helicopters."

Considering the armed helicopters currently available, the stopping power accessible in the future to the MND(C) will consist of the Belgian Agusta A-109, the German Bo-105, the British Lynx and the addition of an aggressive capability provided by British and Dutch attack helicopters yet to be decided. This combination, in close conjunction with the ground units described above, means that the MND(C) may eventually evolve into an air-mechanized division.

### **Command, Control and Communication**

In order for operational planning, deployment and command to be conducted in an integrated and multinational manner, an appropriate command and control cycle has been developed by the MND(C). To assist decision making and the exercise of command, it has formulated a standard command post (CP).

In the deployment phase and during the course of the occupation of the staging area, the division commander will exercise command from a combined CP in that area. Once mission orders are received and are ready to be executed, the CP will be split into three elements. For emergency action, a forward CP will be moved by air to the area of the mission to be carried out, the committal area. If necessary, local and temporary command can be exercised from a command helicopter; the airborne CP.

To keep the airmobile forward CP small and light, it can be provided with a few personnel and only the most vital communications assets. It is assumed that this CP will be able to function independently for 36 hours, during which time the main CP can be redeployed on the ground. Once it is in place, the commander and his staff can conduct current operations and draw up future plans from here. Meanwhile, the rear CP manages the logistic support function including (air) movement within the staging area.

From a technical point of view, the communications capabilities of the four brigades and the divisional troops are neither fully interchangeable nor always compatible. Because of this, the communications setup between the division, its subordinate units and among the units themselves needs to be standardized. Therefore, a Dutch signal battalion has been added to the MND(C) structure and is presently being reconfigured to meet our requirements. So the division can operate independently of external support communications and continue to operate at long range, the signal battalion will need to be well equipped with radios, transmitters and satellite communications. Within the division, satellite equipment will be necessary to link the committal and staging areas and provide necessary

external communication capabilities. Besides being capable of transmitting over major distances, communication assets must also be easily transportable (airmobile) and not hindered by mountain ranges or other built-up area obstacles.

### Leadership

Setting up and running the MND(C) is a complex task that is being accomplished by our dedicated staffs, assigned units and the military centers of the countries involved. Concerning leadership, it is of particular importance for the commander to pay attention to the integration of four different military cultures, not just among his staff, but also at unit level in the field. Unencumbered by any traditional ways of thinking, a new and distinctive multinational culture can evolve at MND(C) headquarters and radiate to the division's units. This command is something altogether new, although it draws upon the experience of the Allied Command Europe Mobile Force (Land). The MND(C) culture must carefully foster a reputation for the division within the Alliance and beyond, so that this in itself becomes an aid to crisis management. We are realistic enough to recognize that much work still lies ahead of us. Nevertheless, we have started well because the countries involved have contributed outstanding officers and soldiers who look on the MND(C) as a new challenge.

Two important basic principles of war are already fundamental in time of peace to the leadership of this multinational division: simplicity and human factors. The quality of the final product—a combat-ready and deployable formation—will ultimately be dictated by how it is perceived by the outside world. In other words—its image. This is not just a matter of attributes, such as helicopters, weaponry, logistic resources or training. Above all, it is about human factors which find expression in combat readiness, multinational spirit and discipline. Communication is vital, both inside and outside

***The quality of the final product—  
a combat-ready and deployable formation  
—will ultimately be dictated by how it is  
perceived by the outside world.***

***In other words—its image. This is not just  
a matter of attributes, such as helicopters,  
weaponry, logistic resources or training.  
Above all, it is about human factors which  
find expression in combat readiness,  
multinational spirit and discipline.***

the division. This means keeping one another abreast of developments, speaking a common military language and being open to the ideas of others. Finally, symbolism plays an important role in how soldiers perceive and respond to assignments in the new NATO formation. To date, the response has been extremely positive as soldiers and leaders identify with the project and proudly display the MND(C) badge. As we continue to execute operations under a common MND(C), how well we communicate our intent to commanders at the unit level will determine our long-term success. Whether we can maintain and build upon our initial momentum is a leadership challenge for us all.

Since April, the MND(C) has formally established and commenced its training program. Each year, the MND(C) will map out the tasks that we must be capable of performing based upon our level of training, materiel resources and emerging operational procedures. A process has thus been set into motion whereby using highly qualified national military elements, a cohesive multinational RRF can be built up; one ultimately capable of taking on a wide range of tasks within the NATO area or beyond, if needed.

We are confident that the MND(C) shall succeed, and we consider it a challenge and a privilege to take the lead in this process. **MR**

*Major General Pieter Huysman, Royal Dutch Army, is the commander, Multinational Division Central (Airmobile). He has served in a variety of command and staff positions in the UN and allied assignments throughout the Netherlands and Europe, including deputy chief of the army staff for Operations; commander of Dutch Forces in Germany; and commander of the Dutch 41 Armored Brigade. General Huysman is a popular lecturer on modern warfare and leadership both inside and outside of the military establishment.*

# Rules of Engagement

## Lessons from *Restore Hope*

Jonathan T. Dworken

*UN forces deployed to Somalia for a humanitarian relief mission faced a unique situation. Operations involved not only humanitarian efforts but also required dealing with security, forced entry, crowd control and the threat posed by rival Somali factions—all within the framework of doctrinal rules of engagement. The following articles highlight the experiences of US forces in this complex environment.*

**WHEN TO SHOOT?** Among the many difficult decisions that soldiers face during operations, none is as challenging, frustrating, critical and closely examined as “when to shoot?” Just ask Gunnery Sergeant Harry Conde, a Marine who participated in Operation *Restore Hope*. When his convoy slowed at an intersection in Mogadishu, a Somali reached in to steal his sunglasses. Conde, who later argued that he thought he was being attacked, fired his weapon as the convoy was pulling away. The result: two Somalis were wounded, and Conde was convicted of aggravated assault for using excessive force. The military jury in Mogadishu ruled that Conde was not acting in self-defense, so the shooting was not within the rules of engagement (ROE) regulating the use of force during the operation.

Whatever one makes of the Conde case, the incident is indicative of the ROE problems during *Restore Hope*. When taken in the context of the whole operation, however, these problems were minor. After every shooting, the military command reviewed the situation and, if necessary, conducted an official investigation to determine if excessive force was used. These inquiries led to four Article 32 cases (the military equivalent of grand jury hearings) and two courts-martial.<sup>1</sup>

Considering the number of soldiers involved in the operation and its duration, as well as the

difficult and ambiguous situations soldiers faced daily, it is amazing that there were so few cases. In fact, most observers view ROE as a contributor to the success of the *Restore Hope* mission (later problems in Somalia notwithstanding).

It is clear that ROE lessons learned over the last decade were used during *Restore Hope*. But *Restore Hope* witnessed a series of minor ROE problems, and several new and completely unexpected issues arose. The military is now encountering some of the complexities of implementing ROE in different types of situations.

Because the military may face operations similar to *Restore Hope* in the future, examining how Unified Task Force (UNITAF)—the US-led coalition—handled ROE issues, or in some cases did not, may be instructive. This article examines the issues surrounding ROE for ground forces in *Restore Hope* from the start of the operation in December 1992 to the UN command transition in May 1993. Its purpose is to identify potential ROE problems that commanders in future operations may face and draw lessons learned from *Restore Hope* for dealing with these problems.

### Situation in Somalia

After the 1991 ouster of Somalia's leader Siad Barre, the country split into various factions, mostly along clan lines. Fighting between these groups ravaged the country's capital and much of southern Somalia and led to further breakup

of the country, banditry and starvation. Continued violence prevented humanitarian relief agencies from providing enough assistance to the Somali people. The UN deployed a force to the region to monitor a cease-fire between the rival factions. But the factions were uncooperative and the UN force was too small (limited by mandate) to enforce peace.

As starvation became more widespread, the UN authorized a US-led military intervention in December 1992. The US Central Command (USCENTCOM) established Joint Task Force (JTF) *Somalia* to perform *Restore Hope*. The staff of the First Marine Expeditionary Force (I MEF) formed the nucleus of the JTF staff. The objective of *Restore Hope* was to provide a secure environment to ensure the delivery of relief supplies.

Two aspects of the threat environment faced by US troops in Somalia were relevant to the ROE situation and show the complex environment in which these troops had to make decisions about the use of force. First, Somali factions, and most of the population, were well-armed. Guns were an ever-present aspect of Somali life, and carrying them in the open was very common before UN intervention. Soldiers had difficulty distinguishing between a Somali with a gun who might threaten them and one carrying a gun merely for self-protection. Second, the lack of schools, massive unemployment and poverty led young Somali males to form roving gangs and turn to thievery. Most military and relief vehicles that stopped in towns due to traffic faced swarms of children trying to steal anything they could.

### US Military ROE

The purpose of US military ROE is to influence the employment of armed force. The rules cover when, where, against whom and how force can be used. As one expert noted, "The essence of any rules of engagement is the decision to shoot or not to shoot."<sup>2</sup> Joint doctrine defines ROE as rules "which delineate the circumstances and limitations under which United States forces will initiate and/or continue combat engagement with other forces encountered."<sup>3</sup>

For political decision makers and commanders, ROE is a means to control the use of force;

for soldiers, ROE is the framework that guides them in the use of force. The key question ROE addresses—when can force be used—centers on three distinct concepts focusing on hostile act,

---

*[USCENTCOM's ROE was] based on [its] standing peacetime ROE. . . . When US forces are attacked by unarmed hostile elements, mobs or rioters, they should use the minimum force necessary under the circumstances and proportionate to the threat. Restore Hope ROE directed soldiers to use a graduated response to such threats. . . . [but] stressed the right of self-defense, stating that "Nothing in these rules of engagement limits your right to take appropriate action to defend yourself and your unit."*

---

intent and force. As Captain J. Ashley Roach, US Navy, pointed out in his article, ROE centers on the inherent right of self-defense.<sup>4</sup>

The use of deadly force against a hostile act is straightforward—if being attacked, soldiers can use deadly force to protect themselves. The use of force against hostile intent, which is called anticipatory self-defense, is more complex. A soldier does not have to be fired upon before he can use force; that is, he does not have to "take the first hit." Instead, he can use force when he expects he will be attacked. But several conditions are attached to anticipatory self-defense: the threat of attack must be imminent, and the use of force must be immediate, proportionate and necessary.<sup>5</sup>

Under wartime ROE, a commander in chief (CINC) may define an opposing force as hostile. If so, soldiers are allowed to use deadly force against the hostile force regardless of whether the opposing force is engaging in a hostile act or showing hostile intent. Although these phrases were not used during World War II, Japanese and German soldiers were defined as hostile forces.

It is sometimes useful to distinguish between the high-level ROE that the CINC gives the



Somalis detained by 10th Mountain Division soldiers in Kismayu, February 1993.

*Guns were an ever-present aspect of Somali life, and carrying them in the open was very common before UN intervention. Soldiers had difficulty distinguishing between a Somali with a gun who might threaten them and one carrying a gun merely for self-protection.*

commander of a joint task force (CJTF) and the more specific operating rules based on the ROE that the CJTF gives to the forces assigned to him. A CJTF may tailor the operating rules to specific situations and make them more restrictive than the ROE, but he may not make them more permissive.

### ***Restore Hope ROE***

USCENTCOM developed a rather straightforward ROE for *Restore Hope* based on USCENTCOM's standing peacetime ROE. The ROE did not designate a hostile force, owing to the unclear nature of the threat and the humanitarian nature of the mission. The ROE did authorize soldiers to use force against a hostile act or hostile intent and allowed the use of deadly force against a hostile act.<sup>6</sup> However, the ROE called for as restrained a response as possible.

When US forces are attacked by unarmed hostile elements, mobs or rioters, they should use the minimum force necessary under the circumstances and proportionate to the threat.<sup>7</sup> *Restore Hope* ROE directed soldiers to use a

graduated response to such threats, including issuing verbal warnings and showing force.

Finally, the ROE defined armed Somalis, who were neither attacking nor threatening soldiers, as "threats." Within those areas under the control of US forces, armed individuals may be considered a threat to US forces and the relief effort whether or not the individual demonstrated hostile intent. Commanders were authorized to use all necessary force to disarm groups or individuals and demilitarize those areas under their control.<sup>8</sup>

What this meant was that soldiers could challenge and use force to disarm Somalis. One can think of a "threat" as a potentially hostile force (that is, between friendly and hostile). *Restore Hope* may in fact be the first operation in which a command defined potential threats in this manner in the actual ROE and linked them to disarmament. Unfortunately, defining threats and saying they could be challenged—but not necessarily that they should be—caused soldiers to confuse ROE with weapons confiscation policy to be discussed below.

USCENTCOM issued the ROE to CJTF *Somalia*, who in turn issued operating rules based on the ROE to his forces. These rules, which USCENTCOM called "implementing/operating guidance," were contained in unclassified cards given to all soldiers. The ROE and operating rules were very similar. Therefore, the term ROE is used to describe both ROE and operating rules throughout this article.

There are several noteworthy ways in which the CJTF turned the ROE into operating rules. First, the CJTF did not make the operating rules more restrictive than the ROE, as he was allowed to do. Second, the ROE card mentioned some things that were not in the ROE but were important in helping soldiers understand the mission, commander's intent and background of the ROE (such as, "the United States is not at war"). This information helped soldiers make appropriate decisions on the use of force. Third, the card stressed the right of self-defense, stating that "Nothing in these rules of engagement limits your right to take appropriate action to defend yourself and your unit." Finally, the card reiter-

ated the traditional notions that soldiers should use the minimum force necessary and proportionate to the threat.

### Ten Restore Hope ROE Issues

What is a ROE issue? Narrowly defined, such issues might only center on the writing and following of the ROE. This article takes a broader view: any issue that deals with the use of force during the operation is a ROE issue. After all, the use of force is what the ROE is supposed to guide.

**ROE for Humanitarian Operations.** When USCENTCOM was developing the *Restore Hope* ROE for the humanitarian operation in Somalia, there was tension between competing objectives. If the ROE was too restrictive, it would not allow soldiers to protect themselves and could hamper operational effectiveness. It was necessary to allow sufficient force to be used to deter warlords or bandits and demonstrate US resolve in delivering relief supplies. If the ROE was too permissive, US forces might have been perceived as using excessive force. If that happened, the mission might no longer have appeared humanitarian in nature, and the military could have lost support at home and abroad and faced conflict escalation on the ground.

USCENTCOM balanced these competing objectives by basing the *Restore Hope* ROE on the standing USCENTCOM peacetime ROE and then making adjustments for the special situation in Somalia. A great deal of effort had been put into writing the peacetime ROE, and it was well-known and understood. For the most part, USCENTCOM simply applied the baseline rules on hostile acts, intent and force to the operation.

**ROE Dissemination.** The JTF disseminated the ROE and operating rules via operation plans (OPLANS), 35,000 unclassified cards given to soldiers, briefings, command information channels and training scenarios for soldiers. The cards were probably the most effective tool because they were clear and concise, ensuring maximum understanding and dissemination. The I MEF printed and issued them before troop deployment to ensure that troops had them when they entered the country.



A Marine prepares to search a building in Mogadishu.

*"The essence of any rules of engagement is the decision to shoot or not to shoot." Joint doctrine defines ROE as rules "which delineate the circumstances and limitations under which United States forces will initiate and/or continue combat engagement with other forces encountered."*

**Article 32 Cases.** There were several high-visibility Article 32 cases in February and March 1993, in which soldiers were accused of inappropriate use of force. The Conde case was one such incident. In another case, Sergeant Walter Johnson shot a Somali running toward his vehicle because he believed the Somali was carrying a hand grenade. Johnson was later cleared of any wrongdoing because he had acted in self-defense. The command in Somalia was very hesitant to issue any clarifications to soldiers about the cases because military commands are restricted in the information they can release by Staff Judge Advocate (SJA) General regulations, legal ethics and concern that it might influence decisions in the cases. But many soldiers naturally assumed the worst—that the soldiers accused were being "strung-up" to appease Somalis, politicians and the press.

**ROE Explanations and Clarifications.** Several units asked for tailored ROE explanations and clarifications. Tailored explanations focused on particular instances that specific units might



find themselves in. For example, the JTF SJA wrote a convoy commander's briefing that was never disseminated. Clarifications focused on ROE questions, such as whether soldiers could use deadly force to protect weapons.

Differences of opinion concerning tailored explanations and clarifications reflected differing service cultures. Many Army officers and

---

*If the ROE was too restrictive, it would not allow soldiers to protect themselves and could hamper operational effectiveness. . . .*

*If the ROE was too permissive, US forces might have been perceived as using excessive force . . . the mission might no longer have appeared humanitarian in nature, and the military could have lost support at home and abroad and faced conflict escalation on the ground.*

---

staff lawyers usually favored clarifications. On the other hand, many Marines—including some of those on the JTF staff—usually felt that it was better to let the soldiers rely on their good judgment and not confuse them with more rules. An example of the Army's approach to more specific ROE can be seen in the Army's *Restore Hope* OPLAN, which did not just reiterate the JTF ROE on hostile intent but listed several ways in which soldiers could tell if they faced hostile intent.<sup>9</sup>

Some officers thought that in the *Restore Hope* case—in which a Marine JTF had control over Army units that expected more detailed ROE explanations—it might be better to err on the side of issuing the guidance that subordinate commands may expect.

**ROE Precedence.** Soldiers in Somalia sometimes confused ROE with other rules governing the use of force. For example, Marine Corps guard rules allow the use of deadly force in several circumstances which include apprehending or preventing the escape of an individual and protecting weapons or other property.<sup>10</sup> The crux of

the problem in Somalia was confusion over which rules took precedence in that area of operations: the unclassified cards given to soldiers or the actual ROE.

**Proportionate Force.** One of the most challenging ROE problems in Somalia concerned the use of proportionate force against low-level threats. Due to the uncertain nature of such threats, the command had given only limited thought to this problem before the operation. Although the ROE directed an incremental, graduated response, effective methods of defense short of deadly force were practically nonexistent. Somalis learned quickly that despite verbal warnings and shows of force, US soldiers would not shoot at children throwing rocks or swarming vehicles to steal things. There was little that could be done at first. The results were injuries to soldiers (some serious wounds from thrown rocks), frustration and inappropriate actions (such as throwing rocks back).

Soldiers eventually discovered more appropriate solutions to the problem.<sup>11</sup> One solution was to avoid these low-level threats by taking alternate driving routes, not driving during rush hour and putting barbed wire around vehicles to prevent Somalis from jumping onto them. Another solution was to develop means to counter these threats—means short of deadly force—including carrying tent pegs, batons and sticks to repel Somalis.

**Cayenne Pepper Spray.** When lesser measures of nondeadly force failed and verbal warnings went unheeded, cayenne pepper was an effective means of proportionate force against low-level threats. The spray helped soldiers avoid the dilemma of using other nondeadly means of force, many of which proved to be ineffective, and using deadly force which was usually not appropriate. The spray was so effective that merely waving any aerosol can in the air was said to ward off Somalis by the end of the operation.<sup>12</sup> It was an effective deterrent because soldiers used it and Somalis learned they would.

There were, however, two unexpected problems with the use of cayenne pepper spray.

Manne Corps Gazette



A Marine mans Checkpoint 77 astride the Green Line separating rival clans in Mogadishu, March 1993.

*Differences of opinion concerning tailored explanations and clarifications reflected differing service cultures. Many Army officers and staff lawyers usually favored clarifications. On the other hand, many Marines—including some of those on the JTF staff—usually felt that it was better to let the soldiers rely on their good judgment and not confuse them with more rules.*

First, fear of inappropriate use led to a delay in requesting to obtain and use it, as well as a lengthy approval process. Second, some soldiers were already hesitant to use deadly force, even when appropriate, due to pending Article 32 cases. They became more hesitant because cayenne pepper spray could be used as a substitute for deadly force. In one instance, a Somali attacked a soldier with a knife. Instead of shooting the Somali, other soldiers nearby used the spray. Although the spray worked and the Marine escaped unharmed, the Somali had attempted to stab one Marine four times before he was subdued with the spray. In this case, deadly force may have been called for, but the Marines saw cayenne pepper spray as a substitute for deadly force, instead of as a complement.

**Weapons Protection.** A significant point of disagreement and confusion was whether the ROE allowed the use of deadly force to protect weapons. At one point, the Army inserted a statement in its fragmentary order stating: "Use of deadly force is authorized to prevent theft of weapons or NVGs (night vision goggles)."<sup>13</sup> After some discussion, the CJTF decided that deadly force could be used to protect only weapons, but the decision was not disseminated.

This decision caused several dilemmas. First, it did not distinguish between two cases. In one instance, a Somali stealing a weapon and then threatening a soldier with it on the spot, clearly called for the use of force under "hostile intent." In another case, a Somali stealing an unloaded gun and running away with it slung over his back, may not present an immediate threat to the



*The weapons confiscation policy changed throughout the operation; ROE did not. The weapons confiscation policy was designed to reduce the capability of factions and bandits to conduct attacks and thereby lower the level of violence in the country.*

soldier. However, the soldier might want to shoot the Somali to prevent the gun from falling into the wrong hands and being used against the US military in the future.

Because there were so many guns in Somalia, it is not clear why using deadly force to stop a Somali from stealing a pistol was appropriate but using deadly force to stop him from stealing NVGs was not. After all, the NVGs could have given a potential attacker a greater tactical advantage than a pistol. Finally, it is not clear why,

if it was acceptable for a soldier to use deadly force to protect a weapon, the decision was not widely disseminated.

**Weapons Confiscation Policy.** There was confusion between the weapons confiscation policy and ROE. The weapons confiscation policy changed throughout the operation; ROE did not. The weapons confiscation policy was designed to reduce the capability of factions and bandits to conduct attacks and thereby lower the level of violence in the country. This policy dictated when a soldier could challenge and disarm a Somali. The command promulgated changes in weapons confiscation rules in a series of commander's policy guidance, which might be thought of as operating rules.

The confusion between ROE and the weapons confiscation policy had its roots in the ROE section that defined armed individuals as threats and stated that they "could" be challenged. This section did not say whether such individuals "should" be challenged though. That decision was left to policy guidance. In this case, ROE was permissive; policy guidance was directive.

**Multinational Operations.** UNITAF wanted to release US ROE to coalition forces to coordinate ROE issues with them. USCENTCOM developed a releasable version that was given to coalition allies. USCENTCOM and UNITAF strongly urged foreign commanders to adopt US ROE.

Most coalition members appeared to adopt it, though some made changes. They probably agreed to use US ROE for several reasons:

- US and coalition commanders had similar strategies to counter current threats.
- Failure of the first UN mission in Somalia was partially attributable to restrictive ROE.
- More permissive ROE was not conducive to the humanitarian nature of the mission.
- Coalition forces faced few national political constraints due to relatively few casualties sustained during the mission.
- Most foreign military forces do not place as much emphasis or thought on ROE as does the United States.

This review of ROE in Operation *Restore*

A crowd of demonstrators supporting General Mohammed Farrah Aideed moves menacingly toward allied forces.

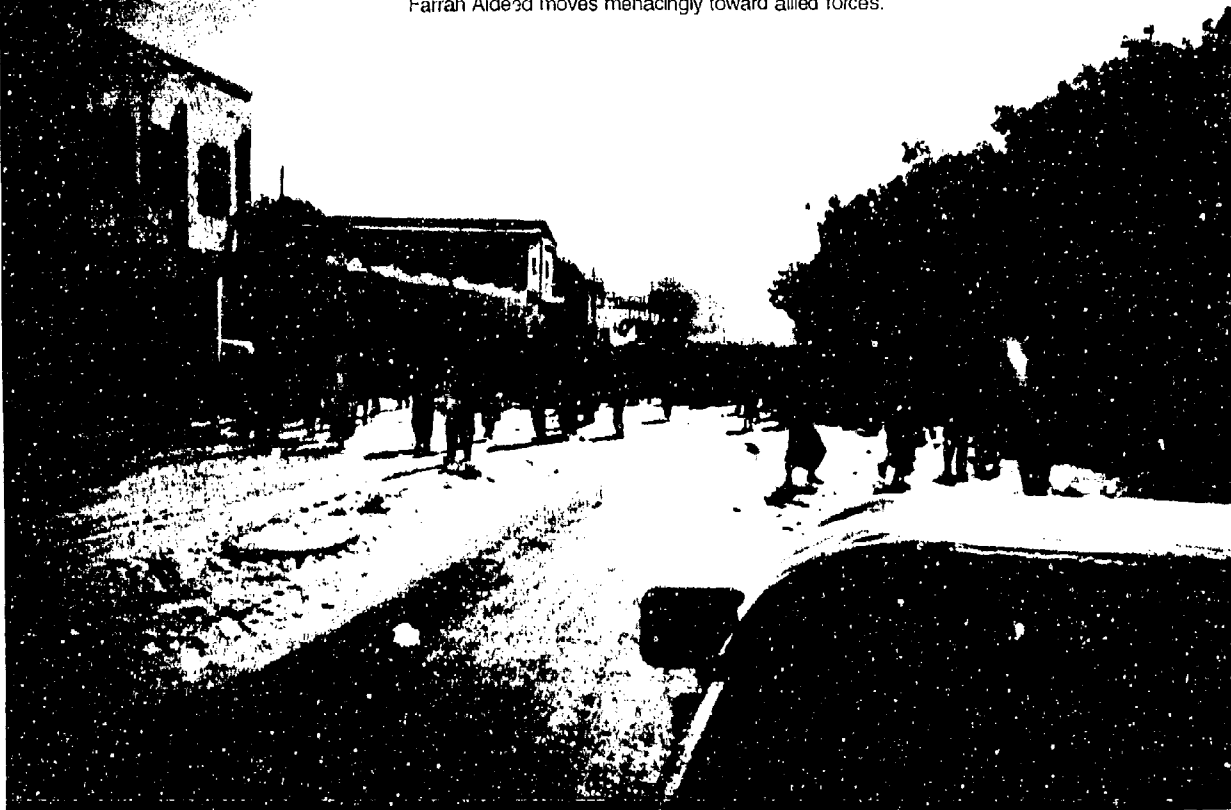

*[At first] effective methods of defense short of deadly force were practically nonexistent. Somalis learned quickly that despite verbal warnings and shows of force, soldiers would not shoot at children throwing rocks or swarming vehicles to steal things. . . . The results were injuries to soldiers, frustration and inappropriate actions (such as throwing rocks back).*

Hope leads to several lessons for future leaders:

- Commanders should develop ROE appropriate for the situation to ensure that a proper balance is struck for humanitarian operations and other similar relief missions.
- ROE should be based on standing peacetime ROE and written in a clear and easily understood manner that is neither too restrictive nor too permissive.
- Leaders must make important decisions before the operation begins. It is extremely important to determine whether deadly force can be used to protect weapons and equipment and to consider what nondeadly means of force may be appropriate for the situation.
- Gain the necessary approval from higher headquarters before an operation begins to ensure the CJTF has the authority to use riot control

agents and distribute cayenne pepper spray to his troops.

- Write operating rules based on the ROE in a clear and concise manner.
- Distribute the completed ROE cards before troop deployment.
- Develop training or exercise aids to ensure that soldiers understand the ROE and are not just memorizing them.
- Consider carefully tailored ROE explanations, especially for units from services that expect them.

A serious leadership challenge is ensuring that soldiers do not confuse ROE with other guidelines. Soldiers must understand that ROE takes precedence over all other rules governing the use of force, and they must know the difference between ROE and the weapons

***Cayenne pepper was an effective means of proportionate force against low-level threats. The spray helped soldiers avoid the dilemma of using other nondeadly means of force, many of which proved to be ineffective, and using deadly force which was usually not appropriate. The spray was so effective that merely waving any aerosol can in the air was said to ward off Somalis by the end of the operation.***

confiscation policy.

Commanders should disseminate appropriate information on the use of force during the operation. Commanders should clarify any incidents of inappropriate use of force so soldiers are not hesitant to use force when necessary, which nondeadly means of force are appropriate and which are not, and that cayenne pepper spray is not a substitute for appropriate use of deadly force.

At the same time, leaders should be wary of an important lesson learned from *Restore Hope*: ROE will continue to present major problems in future operations. ROE problems were minor in Somalia for two reasons. First, the potential costs of soldiers overreacting (such as, shooting

when they should not) were small due to the small chance of conflict escalation. The potential costs of soldiers underreacting (not shooting when they should) were also limited because there were relatively few threats to soldiers.

Second, except for a few specific instances, multinational operations were coordinated, not combined. That is, the troops operated in different sectors so any difference in "national" ROE was unlikely to spill over. If operations had been closer, as they were in the city of Mogadishu, small ROE differences could have been much greater.

ROE has been highlighted as a major success story from *Restore Hope*. The USCENTCOM staff wrote an appropriate ROE, and officers in Somalia at all levels of command, from the JTF to service components, to unit leaders, ensured that ROE was well implemented. Despite a few incidents, soldiers on the ground made good decisions on the use of force in difficult situations time and again.

But some minor problems and new and unexpected issues arose. When they did, it took time for officers to recognize the problems, develop means to deal with them and gain approval from higher headquarters. We must continue to address these issues so commanders can prepare to deal with them in future operations. **MR**

#### NOTES

1. G. E. Lorenz, "Law and Anarchy in Somalia," *Parameters* (Winter 1993-1994):33.

2. Norman Friedman, "The Rules of Engagement Issue," E. F. Guentz, Norman Friedman, Clarence Robinson and William R. Van Cleave, *NATO's Maritime Strategy, Issues and Developments* (Washington, DC: Pergamon-Brassley's, 1987), 37.

3. Joint Pub 1-02, *Department of Defense Dictionary of Military and Associated Terms* (Washington, DC: US Government Printing Office, 1 December 1989), 317.

4. Captain J. Ashley Roach, "Hubs of Engagement," *Naval War College Review* (January-February 1983):49-50.

5. The RAND Corporation, RAND Note N-2963-CC, *Naval Rules of Engagement, Management Tools for Cases*, Brad C. Huyos (July 1989), 16-21, and Department of the Navy, Office of the Judge Advocate General, *The Commander's Handbook on the Law of Naval Operations* (Washington, DC: US Government Printing Office, 1987), 4-9 to 4-13.

6. All information on the *Restore Hope* ROE is from UMF-1, *JTF Somalia OPLAN*, Appendix B, Tab A, Annex C (Rules of Engagement) C-B-A-1 to C-B-A-2 (6 December 1992) and *JTF for Somalia Relief Operation Ground Force Rules of Engagement* card (2 December 1992).

7. *JTF Somalia OPLAN*.

8. *Ibid.*

9. US Army, 10th Mountain Division, *Annex N (Rules of Engagement) to II Mountain OPLAN 93-2 (Operation Restore Hope)*, 1-2.

10. NAVMC 2691A, *US Marine Corps Interior Guard Manual*, 21-13 to 21-15.

11. JTF Somalia, Staff Judge Advocate, *Operation Restore Hope After Action Report/Lessons Learned* (March 1992), 21. This is an excellent, complete and valuable source of lessons learned and information from *Restore Hope*.

12. Lorenz, 34.

13. AFHQ, *FRAGO 11 (Marka Operation) to OPCODE 93-2 (Operation Restore Hope)*.

*Jonathan T. Dworkin is an analyst in the Strike and Amphibious Warfare Department, Center for Naval Analysis (CNA), Alexandria, Virginia. He served as a CNA field representative with Joint Task Force Somalia during Operation Restore Hope and is currently serving as a CNA field representative with the Third Marine Expeditionary Force in Okinawa, Japan. He received a B.S. from Georgetown University and an M.A. from Johns Hopkins University.*

# Task Force 2-87

## Lessons from *Restore Hope*

Major Martin N. Stanton, US Army

**D**URING February 1993, there was considerable unrest and factional fighting between two major warlord forces in the southern Somali town of Kismayu. On 22 February, Task Force (TF) 2-87 was alerted by Joint Task Force *Somalia* headquarters to displace the majority of its combat power and command and control (C<sup>2</sup>) elements from Humanitarian Relief Sector (HRS) Marka to reinforce TF 3-14 and the 1st Belgian Parachute Battalion at Kismayu. TF 2-87 was instructed to assume risk and leave a substantially reduced force in HRS Marka to continue security and humanitarian relief operations there. From 23 February to 3 March, TF 2-87(-) conducted operations in HRS Kismayu while TF 3-14 (which was scheduled to depart the theater but had been delayed for over a week due to unstable conditions) conducted security operations north of Kismayu in the Jubba River valley near Jilib.

TF 2-87 operations began with a 400-kilometer road march within 24 hours of notification to move. Within 36 hours of arrival, the TF conducted a combined house-to-house sweep of the city of Kismayu in conjunction with Belgian forces. This sweep took three days and resulted in several fire fights with elements belonging to General Morgan and Colonel Jess, rival Somali warlords. On the third day, rioting and street fighting erupted throughout Kismayu, and TF 2-87 deployed security forces to track down gunmen and terrorists who were randomly spraying civilians with small-arms fire and grenades. During this operational phase, TF 2-87 elements killed five gunmen, wounded or captured five others and apprehended 12 bandits with no friendly losses. TF 2-87 was instrumental in assisting the 1st Belgians separate rioting

---

*Intelligence gathering . . . was based almost exclusively on human intelligence; information provided voluntarily by Somalis or through interrogation of captured bandits or gunmen by CI personnel. CI and special forces units were the most accurate source of information. Direct contact with local informers proved to be the least accurate. Local informers were usually trying to gain advantage over the people they were informing on.*

---

factions. TF 2-87 medics treated more than 70 Somalis, many of whom had been gruesomely tortured by rival factions.

On 2 March, TF 2-87 redeployed Alpha 2-87, which conducted "anti-bandit" operations at Barrawe en route back to HRS Marka. This resulted in the capture of one "technical" vehicle (a special modified truck that carries a machinegun or other crew-served weapon) and four bandits with small-arms weapons. The remainder of the battalion (minus Bravo 2-87, which was attached to the Belgian unit to replace departing TF 3-14 elements) redeployed on 3 March, and all task force assets were in the assembly area in HRS Marka later that evening. No major mechanical breakdowns occurred on either movement, and the task force completed both road marches on schedule with all vehicles. The following battlefield operating systems lessons learned summary details actions taken at Kismayu.

### Command and Control

The use of an airborne observation or command post (CP) greatly enhanced sweep and search operations. During search operations

conducted 25 to 27 February, TF 2-87 and the 1st Belgians made use of an airborne liaison and C<sup>2</sup> team in an Allouette observation helicopter. The team consisted of both battalions' operations officers with a radio configuration that allowed simultaneous communication on command networks. The ability to quickly fly from one side of town to the other, orbit trouble spots and coordinate the actions of the two battalions from the air were key factors in ensuring there were no friendly fire incidents. The helicopter orbited the city daily for three days during the sweep-and-search operation.

---

*During search operations conducted 25 to 27 February, TF 2-87 and the 1st Belgians made use of an airborne liaison and C<sup>2</sup> team in an Allouette observation helicopter. . . . The ability to quickly fly from one side of town to the other, orbit trouble spots and coordinate the actions of the two battalions from the air were key factors in ensuring there were no friendly fire incidents.*

---

Some considerations for using airborne C<sup>2</sup> platforms for this type of operation include:

- Effective in a low or no air defense artillery threat environment.
- Friendly troops and vehicles should have visible markings.
- Helicopter must have room for map boards and jacks for battalion radio nets or ability to use PRC-77 radios.
- Communications capability with ground forces is essential to direct helicopter over any part of overall operation.
- Capability of marking buildings to be searched with smoke grenades or paint bombs.
- Bullhorn or public address system can be used in psychological operations and civil affairs functions.

Exchange of liaison officers (LNOs) with other coalition assets is essential. LNOs were exchanged between the Belgians and TF 2-87

down to company level. Belgian LNOs came with their own Mercedes jeeps and a complete complement of radios that allowed them to operate on both US and Belgian frequencies. The exchange of LNOs at company level was another coordination measure taken to ensure safety throughout operational execution. Although it was impractical to collocate main CPs, LNOs were exchanged between main CPs. This exchange of fully briefed liaison personnel, who were cognizant of both battalions' plans, played a critical role in ensuring that the two battalions worked together without incident in a complicated military operations on urbanized terrain (MOUT) environment.

Based upon this highly successful experience, I strongly recommend the following liaison exchanges: Collocate CPs or LNOs within the respective CPs, in forward CPs, in airborne CPs and down to company level if possible.

Reading grids on a city map can be slow and awkward when a situation dictates rapid response. Use graphics to divide the city into numbered blocks that can be quickly accessed. For example, the southern part of sector B2 allows for immediate reference and identification. It also helps the reaction force quickly apportion responsibility for sectors to subordinate units.

Put up actual signs or paint the sides of the building with phase lines or graphics control measure names. However, this is only effective if you have a secure net and there is no significant electronic warfare (EW) threat. If there is an EW threat, other procedures may have to be implemented.

Dissemination of graphics control measures between task force elements is critical. The Belgians used an alphanumeric system for naming phase lines. US Forces used a proper name system. Control measures should be sorted out in advance to avoid confusion. LNOs should also be placed at contact points if possible to ensure the alignment of forces.

In addition to the airborne CP, we placed a relay point on high ground outside the city to minimize radio dead space. In general, strive to have as many redundant communications links

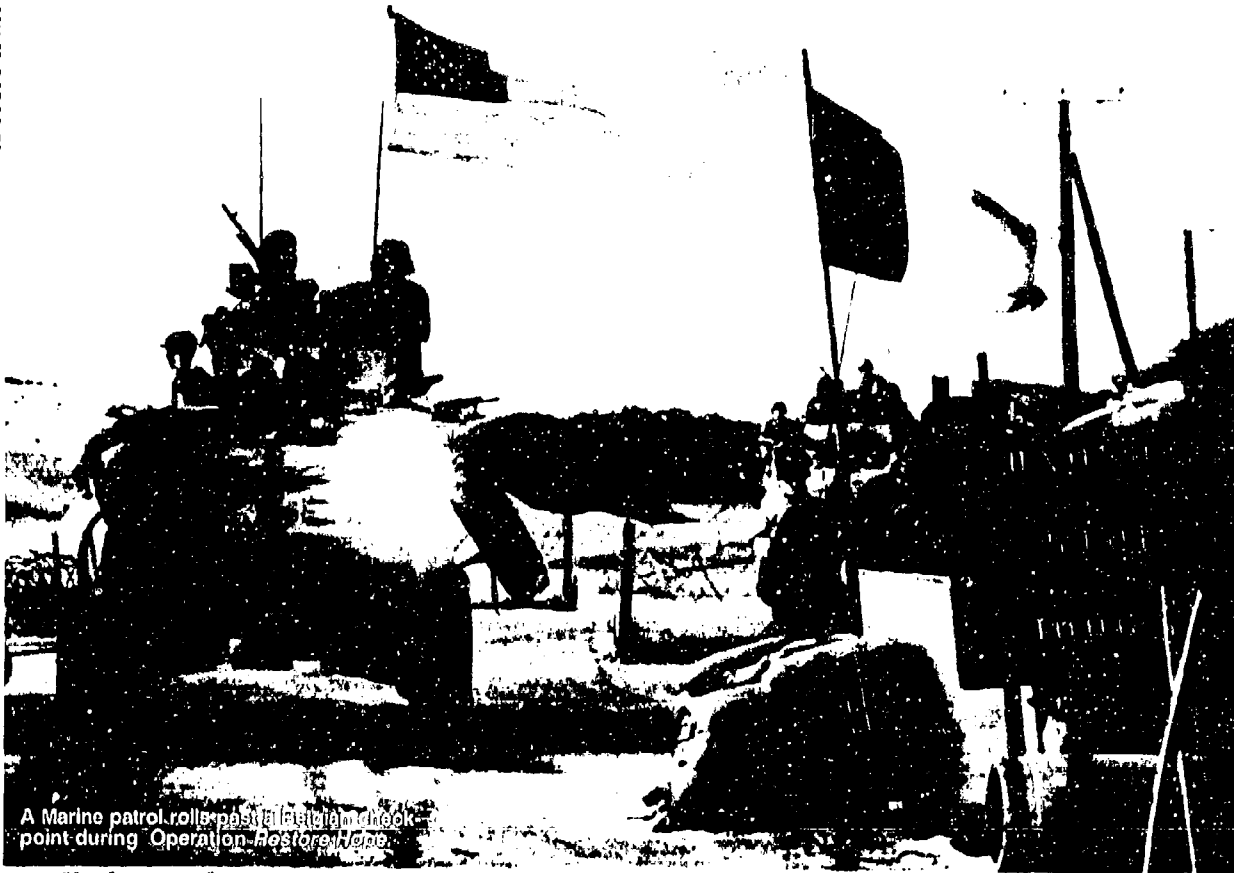

A Marine patrol rolls past a Belgian checkpoint during Operation Restore Hope.

*Exchange of LNOs with other coalition assets is essential. LNOs were exchanged between the Belgians and TF 2-87 down to company level . . . to ensure safety throughout operational execution. . . . This exchange of fully briefed liaison personnel, who were cognizant of both battalions' plans, played a critical role in ensuring that the two battalions worked together without incident in a complicated MOU environment.*

as possible. The TF signal officer should do a communications profile of the city and have subordinate units report any radio dead space encountered.

### Maneuver

MOU was conducted in accordance with prevailing Army doctrine. However, there were several unique characteristics of the Somali operational environment that required certain tactical control measures. Building search teams were squad size because platoon size elements proved too large and fire teams were too small to provide essential security.

Frontage was determined by building type, size and spacing. Squad frontage could be as little as 10 to 25 meters (one building). Another

way of controlling squad sectors was to assign specific buildings to each squad. Once squads completed their searches, they waited until all squads completed their respective buildings before moving to the next set of designated buildings. This ensured control of squad searches and prevented teams from getting ahead of the rest.

To be effective, visible flank coordination must be continuous. Any loss of visual contact with flank forces must be reported immediately.

When encountering small arms fire, the first impulse was to head directly for it. This normally resulted in the gunman getting away because gunmen seldom stay in one place after firing. The correct thing to do is watch the crowd. It will invariably recoil from the direction of fire. Gunmen will not chase their targets. Their





*When encountering small-arms fire, the first impulse was to head directly for it. This normally resulted in the gunman getting away because gunmen seldom stay in one place after firing. The correct thing to do is watch the crowd. It will invariably recoil from the direction of fire. Gunmen will not chase their targets. Their object is a quick flurry of fire and then escape.*

object is a quick flurry of fire and then escape. They will usually flee in a direction opposite the direction the crowd is running.

Based on the direction the crowd is running, try to flank the gunman and anticipate his route of escape by sending troops down side streets. By doing this, you can place yourself on the gunman's route of escape if you are quick enough. Often, running into soldiers unexpectedly will cause the gunman to panic and open fire in an attempt to break contact.

Most engagements took place under 25 meters, some as close as 10 meters. Most, but not all, were at night. Practice firing with NODs (PVS 4s and PVS 7s), point firing techniques and the old Vietnam quick-kill range. Contacts were quick, close and over in a matter of seconds. Troops must be trained to shoot their individual and crew-served weapons while wearing flak vests and helmets. Train your soldiers to run a 100-yard dash in full load-bearing equipment, helmet and flak jacket. They must be able to stop, aim and hit a moving or stationary target in 3 seconds or less. This is normally all the time they will have before the "target" disappears.

Night identification devices such as bud lights and glint tape are lifesavers. Each soldier needs one or the other. Also useful are infrared flashlights and spotlights.

Units need to have sufficient forced entry aids, such as sledgehammers, axes and bolt cutters to properly outfit line squads so that time is not lost getting these items to the forward teams. A good technique is to assign one truck to each platoon and carry all special equipment (mine detectors, entrenching tools and flex cutters) on it.

Mine detectors are essential in searching for buried weapons either in yards or under floors. Watch for freshly turned earth, and sweep all freshly dug graves. Very rarely do Somalis bury metal objects with people. Weapons were found in fresh graves by Bravo 2-87 during Kismayu operations.

Tube-launched, optically tracked, wire-guided (TOW) vehicles were useful in the cordon areas outside of population centers where inter-visibility distances were greater. They used their thermal sights to pick up movement and had the mobility to check out any suspicious activity.

TOW and military police vehicles with spotlights were useful for armed presence or show-

of-force patrols. They were also used to deceive gunmen into believing that UN forces were only patrolling by vehicle at night and could be easily avoided. While this obvious show of force was going on, squad-size dismounted patrols infiltrated into areas that gunmen used to avoid mounted patrols.

Troops learned how and where to look for concealed weapons. Likely places were on roofs and under floors. Often, weapons were broken down and hidden in pieces in wells or water cisterns or wrapped in plastic bags and placed in latrines.

Soldiers should wear minimum equipment due to the extreme heat, physical exertion and the need to move quickly through crowded and restrictive areas. At the same time, soldiers must continue to wear their body armor and helmets. TF 2-87 developed a "stalking uniform" that included helmet, flak vest, weapon, five magazines (four in flak vest pocket, one in weapon), a 2-quart canteen on a strap and a first-aid pouch attached to the flak vest. Each leader carried a PRC-1126 radio in the flak vest pocket. Squad automatic weapon gunners would carry 400 rounds of ammunition. No grenades were carried as this was a violation of the rules of engagement (ROE). An exception was the M203 gunners, who carried six round bandoliers. This light load could be justified because dedicated support vehicles with supplies (water, ammunition and first-aid kits) were always extremely close at hand. The lighter load also gave our soldiers a better chance of dealing with the fleet Somali gunmen.

The Somali people knew the ROE and would push them to the limit. In future operations of this nature, expect insurgents to push the limit and be prepared to deal with this condition quickly and effectively.

### Nuclear, Biological, Chemical

A primary lesson learned during this operation was that riot agents do not respect unit boundaries. If you are going to employ riot control agents, ensure thorough coordination with adjacent units.

Engineer Magazine

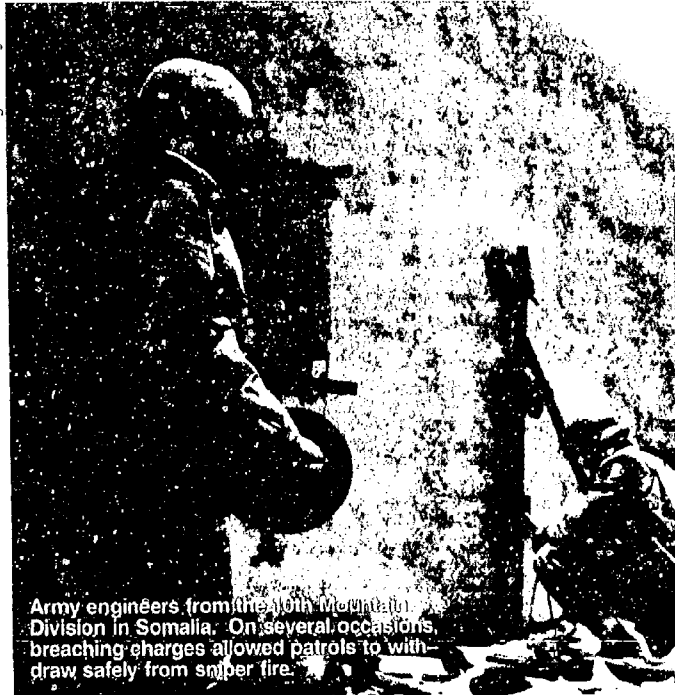

Army engineers from the 10th Mountain Division in Somalia. On several occasions, breaching charges allowed patrols to withdraw safely from sniper fire.

*Sappers performed mobility tasks and emplaced obstacles around base camps throughout Somalia. The Kismayu operation, in particular, presented some unique uses for sappers in low-intensity conflict environments.*

*Concertina wire . . . greatly inhibited the ability of people to flee the cordon area. . . . The obstacle it offered to an aggressor's mobility made a big difference in our ability to grab a trapped gunman before he could escape.*

### Fire Support

Illumination missions proved useful for both screening and city based sweep and search operations. Mortar platoons should increase the amount of illumination munitions they carry. Eliminate white phosphorous and carry only a fraction of the high explosive basic load.

Canister fall is an important consideration. Mortar missions with canister impact in adjacent sectors must be thoroughly coordinated

---

*Troops learned how and where to look for concealed weapons. Likely places were on roofs and under floors. Often, weapons were broken down and hidden in pieces in wells or water cisterns or wrapped in plastic bags and placed in latrines.*

---

*The Somali people knew the ROE and would push them to the limit. In future operations of this nature, expect insurgents to push the limit and be prepared to deal with this condition quickly and effectively.*

---

with the unit in the adjacent sector. Extreme care must be exercised to ensure canisters do not fall in populated areas. Further, illumination missions that are near sector or patrol boundaries must be coordinated with adjacent units to prevent unwanted illumination of their position.

### **Mobility, Countermobility, Survivability**

Sappers performed mobility tasks and emplaced obstacles around base camps throughout Somalia. The Kismayu operation, in particular, presented some unique uses for sappers in low-intensity conflict environments.

Concertina wire was effective in cordoning off portions of the city that were to be searched. Engineers linked the concertina wire together to speed offloading and emplacement from trucks. Rolls were linked together as they stood in the truck bed with one end staked down. As the truck rolled along, the wire was dispensed from the bed. Once the wire had been laid, pickets were pounded into the ground, increasing the resistance of the wire. Ideally, two single strands should be laid side by side. Wire could be laid over several city blocks in a matter of minutes.

The wire fence greatly inhibited the ability of people to flee the cordon area. Like any tactical wire emplacement, it must be monitored by friendly forces. The obstacle it offered to an

aggressor's mobility made a big difference in our ability to grab a trapped gunman before he could escape. Wire was most effective when it had a surprise effect, such as emplacing it at 0430 for a dawn cordon or search. A word of caution though; engineers should be prepared to cut people and animals out of the barbed wire should they become entrapped.

Engineers will be called upon to blow up munitions caches and ammunition captured from bandits. They must have sufficient explosives on hand and be trained in safe, field-expedient demolition of captured munitions.

Sappers should carry pioneer tool kits in their trucks. The same forced entry tools used by infantry units should be readily available for sappers. Additionally, the sapper platoon can be used for a more thorough search of buildings because they have the equipment to rip up floors and excavate wells or shafts. Sappers should also bring mine detectors to search for buried weapons as previously described.

### **Combat Service Support**

Kismayu operational support was made easier by the proximity of a C-5 capable airfield and a fully functioning support base in the port of Kismayu. The following logistics observations were drawn from this exercise.

Units operating from a central base can draw their logistics support there. The proximity to the airfield in Kismayu made deploying a "full up" combat train unnecessary.

A treatment team with the battalion's physician assistant was deployed each day to a forward assembly area where the task force reserve was held. This treatment team was called forward several times to treat Somali mass casualties. A forward deployed treatment team was essential because of the time it took to drive through Kismayu's narrow, winding city streets. Additionally, each company had an ambulance with a senior medic assigned to it. If possible, casualty collection points should be located at prominent, easily accessible intersections, and rooftops can be used as possible helicopter landing zones.

Companies should ensure that resupply trucks with all classes of supply are kept nearby so platoons can be quickly resupplied. Keeping a plentiful supply of water close at hand is critical. The extreme heat and physical exertion make water a potential "war stopper." For planning purposes, 2-quart canteens should be replenished every 2 hours as a minimum.

### Intelligence

Since Kismayu was not TF 2-87's normal area of operation, there was little opportunity to build an intelligence base. The task force relied instead on intelligence provided by TF 3-14, the TF *Kismayu* headquarters and the 1st Belgian paratroopers. Intelligence gathering in Somalia was based almost exclusively on human intelligence: information provided voluntarily by Somalis or through interrogation of captured bandits or gunmen by counterintelligence (CI) personnel.

CI and special forces units were the most accurate source of information. Direct contact with local informers proved to be the least accurate. Local informers were usually trying to gain advantage over the people they were informing on by using US forces to disarm or subdue them. Remember, very few people will volunteer information out of the goodness of their hearts. Most have an ulterior motive. Be suspicious of information that is not checked and evaluated by CI teams.

Because of the nature of the operation, there was very little "top-down" intelligence. TF *Kismayu* only gave vague locations and estimates as to numbers of insurgents or weapons. Nor was there a clear picture of the various factions' intent. The only useful intelligence we received was the "intel" that we developed ourselves or received from other allied operants in sector.

Interpreters are a tremendous source of "real

time" intelligence, but they can also have tribal or factional loyalties. It is normally best to have two interpreters to cross-check each other's translation. The few American citizens of Somali extraction and US soldiers who spoke Somali were our most reliable interpreters and were used for the most important translation duties.

The 1:12,000 resolution maps used in Somalia worked great. To gain the greatest utility in

---

*Interpreters are a tremendous source of "real time" intelligence, but they can also have tribal or factional loyalties. It is normally best to have two interpreters to cross-check each other's translation. The few American citizens of Somali extraction and US soldiers who spoke Somali were our most reliable interpreters and were used for the most important translation duties.*

---

future operations, maps and aerial photos need to be distributed down to the squad level.

Somalis may point out a fleeing bandit as he runs past. However, if they stop pointing, it means the bandit is very near. Be alert! The battalion intelligence officer must maintain templates with the location and time of all contacts. These must be periodically superimposed on map overlays and studied to see if any patterns develop.

During its operations in Somalia, TF 2-87 encountered a wide variety of threats, many of which required innovative approaches. The lessons that this article highlights should provide insights into the often-clouded arena of operations other than war so prevalent today. **MR**

*Major Martin N. Stanton is the assistant J5 for Policy at US Central Command, MacDill Air Force Base, Florida. He received a B.A. from Florida Technological University and an M.A. from the US Naval War College. He was the senior brigade adviser, 2d Saudi National Guard Mechanized Brigade during the Gulf War and was the operations officer, Task Force 2-87 during Operation Restore Hope in Somalia.*

# US Security Interests in the Pacific Rim

Colonel Russell D. Howard, US Army and  
Major Kelly J. Hicks, US Army

*The authors argue that the perception of a secure and stable Asia-Pacific region is premature given current political-military developments. They further point out that increased tension and conflict in the region is a result of the demise of Soviet influence, an enhanced industrial base and proliferation of arms in the Pacific rim.*

AFTER THE fall of the Berlin Wall and the dissolution of the Warsaw Pact, a decade of peace was one of the great prospects of the 1990s.<sup>1</sup> Indeed, once the wary opponents from NATO and the Warsaw Pact joined with neutral countries in Paris to end the Cold War in Europe, there was hope that a similar "architecture" could be applied to the Asia-Pacific region as a means of reducing both superpower confrontation and wasteful arms races among several regional players.<sup>2</sup> Unfortunately, just as the new spirit of cooperation between the former Soviet Union and the United States could not prevent the massive 1990-1991 confrontation in the Middle East, several regional "hot spots" in the Pacific rim also remain unaffected by East-West rapprochement.

In fact, recent events such as the tenuous Middle East peace and the situation in Bosnia-Herzegovina have dominated the news to such an extent that Asia-Pacific security matters have received little attention. Notwithstanding the Gulf War, the dissolution of the Soviet Empire led to a misperception that "security," in a US context, now envelops all regional areas, to include the Asia-Pacific region. Some even argue that a continued military presence in the region is outdated, unnecessary and possibly counterproductive with regard to greater US security interests.<sup>3</sup>

This article argues that the perception of a secure and stable Asia-Pacific region is prema-

ture. It will further argue that increased tension and conflict in the region are a result of the manner in which the absence of the old US-Soviet confrontation has complicated the Asia-Pacific security structure.

Obviously, it is difficult to predict the security outlook for Asia and the Pacific. For the past 45 years, regional security interests were viewed through the lens of the greater East-West confrontation, where regional interests were but a subset of former Soviet Union expansion and US containment policies. Now in the wake of a disintegrated Soviet Union and the prospect of diluted US influence in the region, the lens is clouded and difficult to focus. What then is the significance of the Asia-Pacific region? Is it important? What are the possible near- and long-term threats? Are they significant? In accord with the US military drawdown in Europe and the United States, is the same methodology appropriate for Asia and the Pacific? This article will address these questions.

## Regional Stability

Stability in the Asia-Pacific region is important to US commercial and economic interests, as evidenced by the following statement:

"East Asia, with almost half of the world's population, is the most rapidly growing region in the world. By the end of the century . . . accord-

ing to the IMF [International Monetary Fund], it will account for 30 percent of world GNP [Gross National Product] while the United States will represent only between 18 and 19 percent."<sup>4</sup>

Clearly, disruptions to US trading interests (for economic, political or military reasons) could adversely affect the struggling American economy. . . . President Bill Clinton has articulated his concerns during recent visits to both Korea and Japan.<sup>5</sup>

Politically, the Asia-Pacific region is somewhat of a paradox. Dramatic economic growth, coupled with emerging democratic institutions in Taiwan, South Korea, Singapore and Malaysia have made these countries the envy of the struggling Third World. Paradoxically, North Korea, Vietnam and the People's Republic of China (PRC) still cling to a Marxist ethic that the rest of the world (except Cuba) has discarded. All of these states are potentially destabilizing factors for external adventurism as a means of quelling fermenting internal dissent. While Vietnam seems to be traveling down the road toward economic reform and openness to the West, vis-a-vis the recent warming of relations with the United States, North Korea is becoming more of a threat to regional stability through its irrational nuclear behavior.<sup>6</sup>

Militarily, seven of the world's largest armed forces, to include 10 million ground force soldiers, operate in the region.<sup>7</sup> Evolving strategic realities, especially in view of less influential superpowers, have reaffirmed the importance of sea power to the extent that China, India and more tentatively, Japan, have been acquiring the necessary shipping, including aircraft carriers and nuclear submarines, to pursue extended blue-water ambitions.<sup>8</sup> While regional stability is the current norm, there is the possibility of military confrontation arising out of competition for the region's strategic and nodal crossroads, such as the Straits of Malacca, the Sunda Straits, the Lombok Straits and the South China Sea, which constitute major arteries for regional and extraregional commercial and military traffic.<sup>9</sup>

Generalities are important but what of specifics? Consider the following views:

Militarily, seven of the world's largest armed forces, to include 10 million ground force soldiers, operate in the region. Evolving strategic realities, especially in view of less influential superpowers, have reaffirmed the importance of sea power. . . . While regional stability is the current norm, there is the possibility of military confrontation arising out of competition for the region's strategic and nodal crossroads.

"Asia, is potentially a Middle-East-in-the-making. On the Korean [P]eninsula, close to 2 million armed men, backed by a formidable array of firepower, including probable North Korean nuclear weapons, confront each other across the demilitarized zone. . . . In the South China Sea six countries—Brunei, China, Malaysia, the Philippines, Taiwan and Vietnam—vie, and sometimes fight, over the possibly oil-rich Spratly Islands, which like the disputed Parcels farther north, straddle sea lanes vital to others, including the [United States] and Japan."<sup>10</sup>

"Civil unrest—notably in the Philippines, Papua New Guinea, Cambodia and Myanmar (Burma)—undermines stability in these nations. The February (1991) military coup in Thailand and the continuing insurgency in the Philippines provide graphic evidence of the region's volatility. Student unrest in South Korea inhibits that country's political, economic and social advancement.

Factor in Indian border disputes with China and Pakistan and all its implied nuclear ramifications, and the Asia-Pacific landscape takes on a potentially explosive facade.

In the near term, existing tensions such as those between Pakistan and India and North and South Korea continue to fester and have increased international implications because of the likelihood that some or all of the parties may possess nuclear weapons. While they do not directly affect US security interests, the continuing civil wars in Cambodia and Myanmar and the border dispute in Papua New Guinea

**While energy is not the issue for the United States, confrontation of any kind along a principal sea-lane of communication is unsettling, especially in the absence of the US naval facility at Subic Bay. Other specific long-term threats to stability are difficult to define . . . [and include] the possibility of heightened tension as a result of the withdrawal of US security forces.**

have the potential for regional instability.

Over the long term, claims to the Spratlys by several states may prove contentious as these states look for local sources of energy to hedge against uncertainty in the Middle East. While energy is not the issue for the United States, confrontation of any kind along a principal sea-lane of communication is unsettling, especially in the absence of the US naval facility at Subic Bay. Other specific long-term threats to stability are difficult to define. Included should be the actions of illegal drug barons in Asia, who ship at least 500 tons of illegal drugs across the Pacific by sea or air every year, much of it headed toward US markets.<sup>12</sup> Even harder to define is the possibility of heightened tension as a result of the withdrawal of US security forces. The anticipated withdrawal, many argue, is expected to pave the way for new players like Japan, India and China to project themselves as the region's dominant powers.<sup>13</sup> "The potential for conflict in the region comes from regional powers with hegemonistic ambitions" is a view shared by many Asian leaders, according to former Indonesian Foreign Minister Mochtar Kusumaatmadja.<sup>14</sup> Clinton, significantly, seems to recognize that there is no longer "one threat" in Asia and that it is in the United States' best interest to remain engaged in the region both militarily and diplomatically.<sup>15</sup>

### **The Near-Term Threat**

Because of the potential for nuclear exchange on the Asian subcontinent and the Korean Peninsula, the United States' and, indeed, the world's security interests are very much at risk.

**North and South Korea.** Unfortunately, German reunification, which accelerated the dissolution of the Warsaw Pact, did not prompt a similar occurrence on the Korean Peninsula:

"Despite the talk of reunification and reconciliation bolstered recently by limited instances of inter-Korean cooperation, the two Koreas remain in a state of cold war. Nearly 1.5 million soldiers face each other across a 155-mile-long border, three-fourths as many as are stationed along the entire 4,600-mile-long Sino-Soviet boundary."<sup>16</sup>

In 1991, however, the United States seemed intent on withdrawing substantial numbers of US forces over a five-year period with the realization that a strong South Korea could handle its own defense needs. Also, given the choice of increasing its \$300 million burden-sharing commitment or losing American troops and air bases, former South Korean President Roh Tae-Woo opted for the latter.<sup>17</sup> Little has changed in terms of the strong US and Korean security commitment despite the substantial differences in political views of both Roh's successor, Kim Young Sam, and President Bill Clinton. The United States' and Korea's actions in support of a strong US presence seem prudent when considering the relative strength of the two Koreas. The South has twice the population of the North, four times the GNP and an economy that is growing as fast as that of any other country in the world. For its part, North Korea has defaulted on \$770 million of foreign debt and has an economy that is nearly in complete collapse.<sup>18</sup> It is only in the military arena that North Korea leads:

"Like most communist countries, North Korea over the years has invested disproportionately in the military. It fields more active duty troops, aircraft, naval combat vessels, tanks, artillery and other heavy equipment than South Korea."<sup>19</sup>

However, numbers are not everything. Given South Korea's qualitative edge in both equipment and training, it initially seemed feasible to all parties for a substantial US withdrawal. However, concerns over North Korea's nuclear uncooperativeness led to a withdrawal delay.<sup>20</sup>

Once a signatory to the nuclear Non-proliferation Treaty (NPT), North Korea rejected the terms of the treaty in March 1993, refusing to open its nuclear facilities to international inspection, further fueling speculation that it has developed the capability to manufacture weapons-grade nuclear bombs.<sup>21</sup> North Korea's production of the "No-Dong 1" missile, with a range of 600 miles, now allows it to target South Korea, Japan and China as well.<sup>22</sup> Unilateral measures taken by any of those nations to counter North Korea's nuclear threat (such as Japan building its own bomb) would bring tremendous instability to the region. Despite US and South Korean efforts (such as the cancellation of Exercise *TEAM SPIRIT 94*) to persuade North Korea to comply with the International Atomic Energy Agency and the NPT, there is no sign of headway.

Perhaps North Korea's recalcitrance can be attributed to the loss of Soviet influence. As a superpower, the former Soviet Union had great leverage over North Korean actions. Now, in the absence of Soviet support and guidance, Kim Il Sung's successor, his son Kim Jong Il, could very well make one last attempt at North-South reunification, with the threat or use of nuclear weapons being his only chance for success.

**India-Pakistan.** Increased religious consciousness in both India and Pakistan is exacerbating an already explosive situation in divided Kashmir. Recently there have been particularly bloody periods of civil unrest in Kashmir, and the threat of an all-out war on the India-Pakistan border still remains constant.<sup>23</sup>

The growing belief that Pakistan possesses a nuclear capability and that India is just a spanner's turn away from fielding its own give cause for concern. This is especially true now that both are close to perfecting delivery

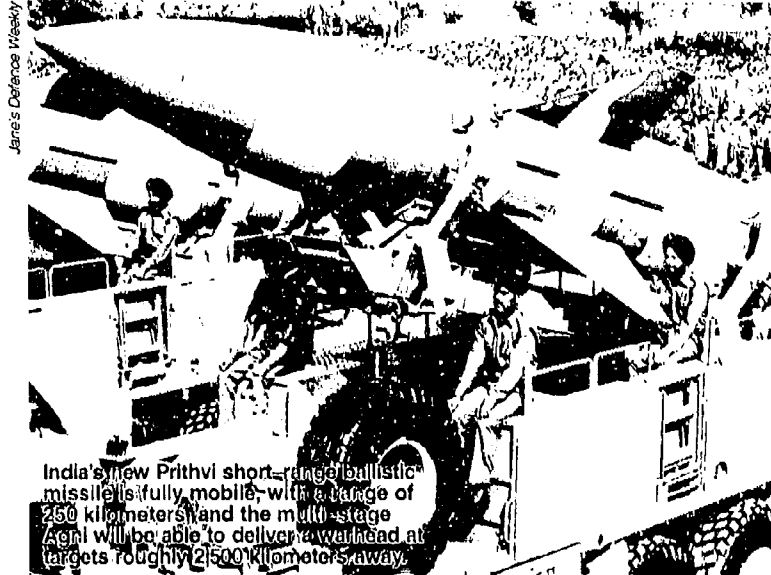

Jane's Defence Weekly

India's new Prithvi short-range ballistic missile is fully mobile, with a range of 250 kilometers, and the multi-stage Agni will be able to deliver a warhead at targets roughly 2,500 kilometers away.

Recently there have been particularly bloody periods of civil unrest in Kashmir, and the threat of an all-out war on the India-Pakistan border still remains constant. The growing belief that Pakistan possesses a nuclear capability and that India is just a spanner's turn away from fielding its own give cause for concern. This is especially true now that both are close to perfecting delivery systems capable of targeting each other.

systems capable of targeting each other.<sup>24</sup>

Most concerned might be the Chinese, who now have to contend with a robust Indian military-industrial complex.<sup>25</sup> This infrastructure supports an expanding sphere of regional influence stretching from the Persian Gulf to Southeast Asia and includes neighboring Nepal, Bhutan, and Bangladesh.<sup>26</sup> This buildup itself may not be a major concern, but India's intent is. While the Indians may not have a clearly defined game plan for their increased capabilities, their past actions give reason for caution.

"Most disturbing is a growing willingness among (Indian) political leaders to make use of the military to pursue foreign policy goals. New Delhi dispatched a peacekeeping force to Sri Lanka in 1987—the troops are still



North Korea's production of the "No-Dong 1" missile, with a range of 600 miles, now allows it to target South Korea, Japan and China as well. Unilateral measures taken by any of those nations to counter North Korea's nuclear threat would bring tremendous instability to the region. Despite US and South Korean efforts to persuade North Korea to comply with the International Atomic Energy Agency and the NPT, there is no sign of headway.

there and sent commandos to foil a coup in neighboring Maldives (in 1988).<sup>27</sup>

Clearly, military action against Pakistan would be a far riskier undertaking than sending forces to Sri Lanka and the Maldives. However, Indian and Pakistani military exercises conducted over the past five years are indicative of planning undertaken by both nations for war; a conflict which could involve the United States because of treaty obligations.<sup>28</sup> Interestingly, the absence of Soviet influence actually increases the prospect for conflict in this instance. As a superpower, the former Soviet Union could both temper the more hawkish Indian tendencies and also dissuade China from intervening. Now, in the absence of a viable Soviet pressure, India has no benefactor to monitor its behavior, and the PRC has less incentive to act responsibly. The most important consequence is that the potential for a nuclear exchange and the possibility of PRC and US involvement could make an Indian-Pakistani confrontation one of the most fatal in history.

### The Long-Term Threat

Predicting long-term threats to stability for any region is difficult. However, remembering that three out of four of America's last major military confrontations started in the Asia-Pacific theater, one can predict with some certainty that the opportunity for conflict, possibly in unusual forms, will occur in the region again in the future. The following

examines three possible scenarios.

**Spratly Islands.** Contested for years by several Asian states, the Spratly Islands have taken on new significance since the Gulf War. "Located astride the major sea lanes between the Persian Gulf and Northeast Asia and over rich fishing and mineral-laden seabeds, ownership of the Spratly Islands is both a strategic and economic prize."<sup>29</sup> Mineral-laden seabeds, in this instance, refer to oil, the supply of which is of great concern to most states in the region, especially Japan.

The 33-island archipelago, which covers over 70,000 square miles in the middle of the South China Sea, is claimed by four Asian states. China and Vietnam claim all 33 of the Spratlys. Malaysia occupies eight of the islands and the Philippines occupy three. China had actually incorporated the entire archipelago into Hainan province and fought a naval engagement with Vietnam two years ago to protect its turf.<sup>30</sup>

The major fear is that the Chinese will become more bellicose in the absence of any Soviet countermeasure. China's regional claims are extensive and Peking has made it known that it does not recognize any other claims to the Spratlys.<sup>31</sup> Complicating the issue is the fact that more than 70 percent of Japan's imported oil is carried on shipping that traverses the archipelago's area. One can easily imagine that the Japanese will not sit idly by if the sea-lanes are threatened as a result of a conflict over the area.<sup>32</sup> Also, given the expected potential from oil, gas and mineral deposits in the area, the Japanese might have territorial interests themselves.

With the demise of Soviet leverage, the United States is the only regional player powerful enough to influence all of the other players simultaneously. However, without a viable 7th Fleet, the United States might be powerless to influence the outcome of a Spratly confrontation.

**Drugs.** Recent data indicate that government interdiction has been successful in limiting cocaine use here in the United States. Higher prices and lower purity on the street are success indicators, as are fewer admissions to emergency rooms for cocaine abuse.<sup>33</sup> Unfortunately, the

indicators are not the same for heroin use. "US drug experts and law enforcement officials, whose prime concern during the 1980's was the spread of crack and cocaine, see ominous signs of a heroin comeback."<sup>34</sup> But this heroin is different from that of the past. Known as China White, it comes from Southeast Asia's "Golden Triangle," where warlords with private armies fight for control of lucrative drug routes leading to the world's drug markets.<sup>35</sup>

"Secretive Asian gangs control import into the United States, one of the drug's principal destinations. China White is not the second rate, heavily diluted heroin familiar . . . a decade ago . . . it [is] a fluffy, potent, smokeable powder. In China White, Asian heroin syndicates believe they have found their answer to cocaine: a drug they can sell to the middle class."<sup>36</sup>

Grown and processed in the "Golden Triangle" countries of Myanmar, Laos and Thailand, China White is transhipped via Thailand, India, China and Hong Kong. Because of the number of states involved in the trade and the nature of their borders, interdiction has been difficult. In some cases, especially in China, law enforcement officials have almost no experience, and local corruption is rampant.<sup>37</sup>

With the China White market come all of the same security and foreign policy problems faced in the Andean cocaine experience. A versatile security assistance program, complete with US military participation, has done much to stem the tide of cocaine traffic. The same commitment to curb the heroin trade might be impossible if a substantial military drawdown occurs in the Asia-Pacific region.

**A Power Vacuum.** Over the past four decades, US naval presence has been a central

Japan's Maritime Self-Defense Force during a recent fleet review.



China's regional claims are extensive and Peking has made it known that it does not recognize any other claims to the Spratlys. Complicating the issue is the fact that more than 70 percent of Japan's imported oil is carried on shipping that traverses the archipelago's area. One can easily imagine that the Japanese will not sit idly by if the sea-lanes are threatened as a result of a conflict over the area.

pillar of Asia's strategic balance. The primary concerns of many strategists are that any US pullout would lead to a power vacuum which Japan, China and India could be expected to fill.<sup>38</sup>

"Virtually every country in the region wants the United States to remain engaged because they regard the United States as a relatively benign power that can check more troubling neighbors."<sup>39</sup>

At times, US influence can appear to backfire, such as US efforts to induce Japan to participate in the military confrontation against Iraq. Because of preoccupation with the Gulf crisis

**With the China White [heroin] market come all of the same security and foreign policy problems faced in the Andean cocaine experience. A versatile security assistance program, complete with US military participation, has done much to stem the tide of cocaine traffic. The same commitment to curb the heroin trade might be impossible if a substantial military drawdown occurs in the Asia-Pacific region.**

and the question of whether Japan should pull its fair share, there was concern, particularly in China, that the US Congress did not grasp the serious implications for Asia of "either a US strategic withdrawal from the region or an enhanced Japanese international military role."<sup>39</sup> As one Chinese strategist explains:

"What we fear is an expansion of Japan's naval power in conjunction with its [present] financial and economic strength. All Asian nations are highly dependent on trade. What would we do if there were a serious clash over some islands? We have the [atomic] bomb, but cannot use it. Once there are more destroyers from the Japanese navy in Asian waters than from the US 7th Fleet, that will be seen as a threat. Japan's naval expansion will accelerate the regional arms race."<sup>40</sup>

For its part, China has recently embarked on a military modernization program that has heightened regional concerns. "The People's Liberation Army (PLA) today is a much revitalized army from the flabby, ill-prepared outfit that fought with dubious distinction against Vietnam in their 1979 border war."<sup>41</sup> Now the PLA is a slimmer, more organized and professional force that is better able to conduct modern warfare. It is a force that supports the new PLA doctrine, which no longer focuses on a defensive war against the former Soviet Union, but extends beyond national boundaries, primarily against Vietnam, India and to the Spratly Islands.<sup>42</sup> Given the enormous size of

China's military establishment (3 million troops), its expanding blue-water capability and the absence of a Soviet threat, a robust American military presence is all the more important to keep the Chinese in check.

The expanding Indian military and naval presence was discussed in general terms earlier. However, specifics are necessary to portray the magnitude:

"India's defense budgets have more than tripled since 1981 and spending has been devoted to procuring an impressive arsenal of state-of-the-art weapons. For the army, with 1.2 million soldiers, this includes nearly 2,000 Soviet T72 tanks. The air force, with some 725 combat aircraft, is being equipped with the latest Western and Soviet models. The navy has leased a Soviet nuclear-powered submarine and has two aircraft carriers and 29 other major warships."<sup>43</sup>

This arms buildup, in conjunction with a robust military industrial complex equal to China's, has given Indian military leadership the confidence to begin generating an offensive military posture focusing on forward defense.<sup>44</sup> How far forward is the matter of concern for all regional players and especially for the Japanese, who depend on free access to the Indian Ocean for most all of their energy supplies. Without Soviet influence, the only counterbalance to possible Indian adventurism is a US naval presence sustained out of Diego Garcia.

However the strategic realities of Japan, China and India evolve, one thing is certain: expanding spheres of interest will not remain mutually exclusive. Eventually, areas of interest will overlap, providing an increased opportunity for conflict and instability. Barring the revival of an authoritarian, expansionist Russia, the only remaining "honest broker" with the military clout to deter aggression is the United States. Losing the leverage provided by US security forces would dilute the brokering mechanism's ability to function.

Just as the "peace dividend" has been an elusive variable of East-West détente, the end of the Cold War did not result in increased security for the Asia-Pacific region. As in other parts of

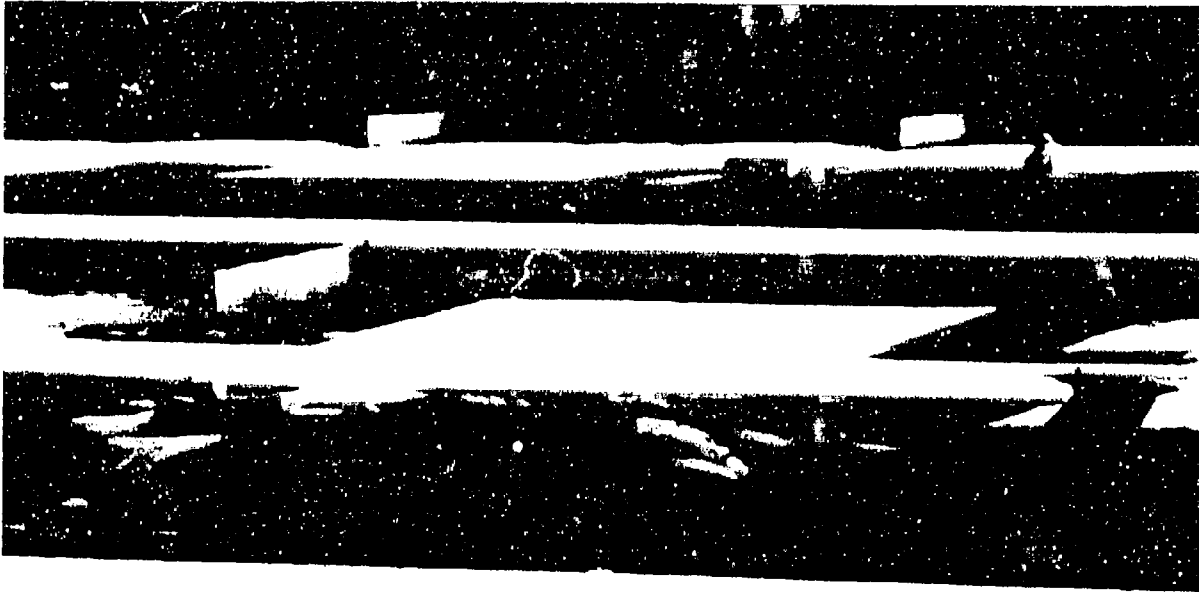

A C-141 transport lifts off from Andersen Air Force Base, Guam. The ability to immediately deploy substantial US ground forces to the Pacific rim greatly enhances the region's stability.

However the strategic realities of Japan, China and India evolve, one thing is certain: expanding spheres of interest will not remain mutually exclusive. Eventually, areas of interest will overlap, providing an increased opportunity for conflict and instability. Barring the revival of an authoritarian, expansionist Russia, the only remaining "honest broker" with the military clout to deter aggression is the United States. Losing the leverage provided by US security forces would dilute the brokering mechanism's ability to function.

the world, with the easing of Cold War tensions and the absence of a bipolar confrontation, many traditional rivalries and unresolved territorial issues are resurfacing in the Pacific rim. Unfortunately, these old rivalries and issues carry with them some very destabilizing baggage. At one extreme is the possibility of nuclear confrontation between the Koreans or between India and Pakistan. At the other extreme is the possibility of Andean style instability brought on by heroin drug trafficking. In between are opportunities for conflict across the entire operational continuum between and among several states, including regional powers such as India, Japan and China.

Unfortunately, regional diversity and historical rivalries make it virtually impossible for any Asia Pacific nation to assume the regional leadership role.<sup>45</sup> Only the United States can play the role of regional leader. Clearly, it is in the national interest to play that role, if for nothing else than to protect American interests in an interdependent world. Moreover, most nations in the region want a strong US presence that includes representative military force.

It is worth noting that while current US military policy for operations other than war places US Armed Forces in the region to conduct peripheral missions such as disaster relief, humanitarian assistance and peacekeeping, the threats

[The PLA's doctrine] no longer focuses on a defensive war against the former Soviet Union, but extends beyond national boundaries, primarily against Vietnam, India and to the Spratly Islands. Given the enormous size of China's military establishment, its expanding blue-water capability and the absence of a Soviet threat, a robust American military presence is all the more important to keep the Chinese in check.

discussed in this article are of a nature which calls for well-trained, forward-based forces.

To be sure, budget constraints, misperceptions about the end of the Cold War and a resurgent isolationist sentiment in this nation will

challenge our leaders' ability to maintain a strong presence in Asia and the Pacific. The United States must meet that challenge because the alternative might be highly detrimental to national interest. *MR*

#### NOTES

1. Paul Beaver, "Conflicts Threaten Decade of Peace," *Fayetteville Observer-Times* (10 January 1991): 2D.
2. Tai Ming Cheung, "The New Disorder," *Far Eastern Economic Review* (13 December 1990): 25.
3. See Selig S. Harrison and Clyde V. Prestowitz Jr., "Pacific Agenda: Defense or Economics?" *Foreign Policy* (Summer 1990): 56-77. Both argue that resources used to maintain military forces in the Asia-Pacific region could be better used to enhance US economic competitiveness. Lack of competitiveness, according to the authors, is the real security threat.
4. Donald S. Zagora, "Clinton's Asia Policy," *Current History* (December 1993): 402.
5. *Ibid.*, 403.
6. *Ibid.*
7. LTG Johnnie C. Coles, "The Army in the Pacific Helps Protect Vital Economic and Political Interests," 1991 *Green Book*, edited by L. James Binder (Arling ton, VA: AUSA, 1991), 160.
8. Tai Ming Cheung, "Command of the Seas—Asian Naval Expansion Contains Potential for Conflict," *Far Eastern Economic Review* (27 July 1989): 16.
9. Jaya Mohideen, "Security Policy in Southeast Asia—a Singapore View," *NATO Review* (October 1990): 27-28.
10. "The Other Ring of Fire," *The Economist* (6 July 1991), 93.
11. Coles, 160.
12. *Ibid.*
13. Michael Vukobrat, "Yankee Please Stay," *Far Eastern Economic Review* (13 December 1990): 30.
14. *Ibid.*, 30-31.
15. Zagora, 403.
16. Doug Bandow, "Leaving Korea," *Foreign Policy* (Winter 1989-1990): 91.
17. "Don't Worry for Now," *The Economist* (3 February 1990), 33.
18. Bandow, 92.
19. *Ibid.*
20. "US to Delay Withdrawals of Troops from South Korea," *Fayetteville Observer-Times* (29 November 1991): 1B.
21. *Ibid.*
22. "North Korea Proposes Nuclear Inspection Deal," *Fayetteville Observer-Times* (November 1991): 13A. Also see Beaver, endnote 1.
23. Tai Ming Cheung, "Build-up Backlash," *Far Eastern Economic Review* (27 July 1989): 18.
24. *Ibid.*
25. Tai Ming Cheung, "Command of the Seas," 17.
26. Tai Ming Cheung, "Build-up Backlash," 19.
27. Salamat Ali, "The Counter-punch," *Far Eastern Economic Review* (26 October 1989): 25.
28. Zagora, 404.
29. Sheldon W. Simon, "The Philippines in a Changing Southeast Asia," *Asian Security in the 1990's*, edited by Steven Durr. Defense Academic Research Support Program 1989, 77.
30. *Ibid.*, 78.
31. Vukobrat, "Maritime Hegemony," *Far Eastern Economic Review* (10 January 1991): 11.
32. "A Hesitant Patroler of the Pacific," *The Economist* (27 July 1991): 29.
33. "Fighting the Pugs Trade—Prospects for Cooperation Between Europe and the Americas," *Wilton Park Conference* (Winston House, Sussex, United Kingdom, 4 June 1991).
34. Moinda Liu, "The Curse of China White," *Newsweek* (14 October 1991): 11-12.
35. *Ibid.*, 10.
36. *Ibid.*
37. Frank Gibney, "Death is the Best Detour," *Newsweek* (14 October 1991): 12-13.
38. Vukobrat, "Yankee Please Stay," 30.
39. *Ibid.*
40. Robert Delfis, "A Two-Front Threat," *Far Eastern Economic Review* (13 December 1990): 30.
41. *Ibid.*
42. Tai Ming Cheung, "Force Projection—China Looks Well Beyond Coastal Waters," *Far Eastern Economic Review* (27 July 1989): 19.
43. *Ibid.*
44. *Ibid.*
45. Martin Lassiter, "Beyond Containment in Asia: An American Strategy for the 1990's," (1990): 5. (I do not remember when I received this paper from Dr. Lassiter. More than likely, it was during the West Point Student Conference on United States Affairs in November 1990 where we were both round table co-chairs.

Colonel Russell D. Howard is the commander, 1st Special Forces Group, Fort Lewis, Washington. His advanced degrees include an M.A. from the Monterey Institute of International Studies and an M.P.A. from Harvard University. He is a graduate of the Armed Forces Staff College and the Fletcher School of Law and Diplomacy, Tufts University. He has served in a variety of command and staff positions in the Continental United States, Japan and Korea including commander, 3d Battalion, 1st Special Warfare Training Group (Airborne), Fort Bragg, North Carolina; deputy chief of staff, 1 Corps, Fort Lewis, Washington; special staff assistant to the Secretary General during UN Operation Somalia II; and deputy commander for the Combined Joint Task Force Haiti Advisory Group.

Major Kelly J. Hicks is the S3 for 1st Special Forces Group, Fort Lewis, Washington. He received a B.A. from Wright State University and an M.A. from Harvard University. He is a graduate of the US Army Command and General Staff College and the Defense Language Institute. He has served in a variety of command and staff positions in the Continental United States, Japan and Korea including detachment command with 7th Special Forces Group, Fort Bragg, North Carolina, and with 1st Special Forces Group, Okinawa, Japan; and commanded the Foreign Language Training Company, JFK Special Warfare Center, Fort Bragg, North Carolina.

# A Southeast Asia Scenario

Major Dana R. Dillon, US Army



*The history, geography and ethnic composition of Singapore and Malaysia have had a profound impact on their national security perceptions, the form and function of their militaries and the corresponding strategies each nation has developed to support its national objectives. The author discusses these policies and how they are further complicated by economic turmoil, political bias and cultural sensitivities due to both nations' multiethnic populations.*

"SINGAPORE is a small Chinese island in a large Malay sea," according to an oft-cited metaphor describing Singapore's military position in relation to its neighbors. Because of the growth of and development of Singapore's military, this metaphor is no longer appropriate. Through the use of a plausible scenario for war between Malaysia and Singapore, this article will demonstrate the inaptness of the metaphor.

Malaysia and Singapore are both made up of three major ethnic groups: Malays, Chinese and Indians. The 1980 census shows that Malays make up 56 percent of peninsular Malaysia's population. The Chinese compose 33 percent and Indians 10 percent.<sup>1</sup> To contrast, in Singapore, the Chinese and Indians constitute 76.1 and 6.9 percent respectively, while Malays make up only 15.1 percent of the population.<sup>2</sup>

After World War II, the British began establishing an independent Federation of Malaysia. Throughout the negotiation process, ethnic sensitivities were paramount considerations. Since 1945, race riots and ethnically based insurrections had been frequent occurrences.

In 1949, the Malays appeared to reach an agreement with the non-Malays to share political power with them in exchange for their assistance in improving the economic position of the Malays. However, when independence was declared in 1957, the new constitution guaranteed the prominence of the Malay language, religion and a Malay head of state.<sup>3</sup>

Singapore joined the Federation in 1963. Bitter debate took place between Singapore and Kuala Lumpur concerning the national identity of the Federation. The dominant Malaysian political party, the Alliance, was nominally a multiracial party. It did include a Chinese component, the Malayan Chinese Association (MCA). However, to Singapore, the MCA appeared overly tolerant of the special status of the Malays. From Singapore, Lee Kuan Yew, the leader of the opposition People's Action Party (PAP), wanted the Malaysian government to represent all Malaysians, not just the Malays. Lee championed a "Malaysian" Malaysia as opposed to a "Malay" Malaysia. Lee and the PAP perceived that the frequent racial disturbances of that time

stemmed from tensions caused by the special position of the Malays over the non Malays. Lee also felt that the racial disturbances provided the Alliance with an excuse to take action

---

*After World War II, the British began establishing an independent Federation of Malaysia. Throughout the negotiation process, ethnic sensibilities were paramount considerations.*

*Since 1945, race riots and ethnically based insurrections had been frequent occurrences. . . . However, when independence was declared in 1957, the new constitution guaranteed the prominence of the Malay language, religion and a Malay head of state.*

---

against the PAP, the Alliance's political rival. From Kuala Lumpur's point of view, Lee and the PAP were political agitators who threatened the established rights and privileges of the Malays and, consequently, the intercommunal peace in Malaysia. The parties were unable to resolve their differences, and Malaysia's Prime Minister Tunku Abdul Rahman forced Singapore from the Federation. The prime minister threatened repressive action against the PAP in August 1965 if its members did not go voluntarily and backed up the threat by placing the military in Johore on alert.<sup>4</sup>

Singapore's expulsion from Malaysia did not resolve the issue of the national character of Malaysia. In Malaysia, elections were held in May of 1969 after an acrimonious campaign, in which the rights of non Malays were a major contention. It appeared that the Chinese and Indians had won a minor parliamentary victory. Riots broke out in Kuala Lumpur and spread to other communities. The riots lasted two weeks, and the ethnically Malay police and army were called in to restore order. Numerous reports indicated partisanship on the part of security forces, resulting in the deaths and injury of hundreds of Chinese and Indians from gunshot wounds.<sup>5</sup> Overlooking the rights of non-Malays, the government sided with the Malay

rioters. The government amended the Sedition Act of 1948, and later the constitution, prohibiting public questioning of the special status of Malays, the power of the Malay rulers, the status of Malay as the national language and the citizenship laws pertaining to non-Malays.

Aggravating an already tense situation, Malaysian politicians accused Singapore of interfering in the elections.<sup>6</sup> Although this charge was officially denied by Singapore, its possible repercussions were taken seriously.<sup>7</sup> On the Singapore side of the causeway, an officer in the Singapore reserves described to me how and when the riot began, the reserves were immediately called up and the entire Singapore military establishment was put on 2-hour alert. The alert stayed in effect throughout the rioting. In Singapore, the May 1969 riot confirmed strong suspicions about the intentions of the Malay majority in Malaysia and encouraged the deepening of defense policies already initiated.

**The Five Power Defense Agreement.** In July 1967, after the split between Malaysia and Singapore, the United Kingdom announced its intent to withdraw from Singapore-Malaysia.<sup>8</sup> Under the provisions of the Anglo-Malaysian Defense Agreement (AMDA), the British had assisted Malaysia with its struggle against Indonesia's *Konfrontasi* and in combating a Chinese-based communist insurgency, the *Emergency*. Although both conflicts had been reduced to manageable size, Malaysia was not fully prepared to go it alone.

For Singapore, the news of the British withdrawal was disastrous. Singapore perceived that the Malaysian attitude toward Singapore's sovereignty was vague at best and hindering at worst. Additionally, Indonesia's *Konfrontasi* had extended to Singapore as well. Singapore's defense capability at this time was negligible, lacking even a rudimentary air force. Lee pleaded to the British and other external partners that Singapore did not have the military capability to oppose a "rapacious piratical attack" by Russian-made Indonesian gunboats or a ground attack from the north.<sup>9</sup> Singapore did succeed in delaying the British withdrawal until 1971. The delay allowed Singapore time to bolster its defense establishment.

The Five Power Defense Agreement (FPDA) was negotiated as a replacement to the AMDA. For both Singapore and Malaysia, the most attractive feature of an extraregional defense arrangement was the protection it afforded them from external security threats. The FPDA is frequently cited as an example of military cooperation inside the Southeast Asia region. To the contrary, the FPDA is an example of Southeast Asian cooperation with countries outside the region.

Malaysia and Singapore negotiated independently with the British and rarely met outside the bilateral negotiations.<sup>10</sup> Unlike the AMDA, the FPDA does not include security guarantees. The FPDA merely calls for "consultations" among the members if a member country is attacked.<sup>11</sup> In part this is a reflection of the distrust between Malaysia and Singapore.

The United Kingdom, New Zealand and Australia did eventually agree to station small numbers of troops in Malaysia and Singapore inside the FPDA framework. This was sufficient for Malaysia's and Singapore's immediate external security needs. Although military forces from all three other powers are welcome in Malaysia and Singapore, Malaysian and Singaporean forces were not welcome in each other's countries.<sup>12</sup> Singapore's and Malaysia's recent revival of the FPDA and inability to initiate a regional defense organization despite their defense interdependence further highlights the continuing mistrust between the two nations.

### National Security Policies

National security policy is a strategy developed by a government to support national objectives. Security policies include military considerations, as well as economic, geographic and social considerations. The military is organized, manned, trained and equipped in such a way as to support the national security policies. The history and ethnic compositions of Singapore and Malaysia have had a profound impact on their national security perceptions and, consequently, have had a concomitant impact on the form and function of their respective militaries.

**Malaysia.** The Malaysian government identifies itself with the Malay community. The Chinese and Indian communities are viewed as alien elements in society. The Chinese and

Indian minorities have not taken the alien status sitting down. As previously noted, riots and insurrections have been their response. Thus

---

*For Singapore, the news of the British withdrawal was disastrous. Singapore perceived that the Malaysian attitude toward Singapore's sovereignty was vague at best and hindering at worst. . . . Singapore's defense capability at this time was negligible, lacking even a rudimentary air force. . . . Singapore did succeed in delaying the British withdrawal until 1971. The delay allowed Singapore time to bolster its defense.*

---

Malaysia's defense policies have concentrated on the internal threat as the greatest danger to Malaysia's security.

Malaysia has responded to the internal threat in three ways. First, in the diplomatic field, Malaysia has sought to reduce any external threats through agreements such as the FPDA. This was done so that Malaysia's limited resources can be concentrated on combating the internal threat. Second, Malaysia has identified the economic and social disadvantages of the Malay population as a principal source of intercommunal friction. The government developed policies such as the New Economic Policy (NEP) to improve the Malay economic position relative to that of the non-Malay population. The third response has been the organization, manning, equipping and training of the Malaysian Armed Forces (MAF) and the Royal Malaysian Police (RMP).

The national policy goal of protecting the rights of the Malays requires the MAF to man and organize its units with an eye on ethnicity. Because police and army units are the most useful in combating internal threats, they are the largest MAF elements. In 1984, the MAF stood at 100,000 personnel, not including the 35,000 reserves or the police. Of that number, 80,000 were in the army.<sup>13</sup> More important is the ethnic composition of the army. Most MAF members are Malay. In 1981, 75 percent of all officers and 85 percent of all enlisted were Malay.<sup>14</sup>





Joint FPDA exercises promote interaction between military powers in the region, but Singapore's and Malaysia's inability to build a regional defense organization highlights the continuing mistrust between the two nations.

*The United Kingdom, New Zealand and Australia did eventually agree to station small numbers of troops in Malaysia and Singapore inside the FPDA framework. This was sufficient for Malaysia's and Singapore's immediate external security needs. Although military forces from all three other powers are welcome in Malaysia and Singapore, Malaysian and Singaporean forces were not welcome in each other's countries.*

Recruitment patterns maintain that ethnic composition. In 1981, over 90 percent of recruits were Malay. Additionally, the Chinese and Indians who join the MAF are generally concentrated in technical army, navy and air force services, away from possible involvement in civil disturbance operations.<sup>15</sup>

The army is organized conventionally. A single corps headquarters controls four divisions of three brigades each. Divided among the 12 brigades are 37 infantry battalions, the most important combat element, particularly in counterinsurgency and civil disturbance operations.<sup>16</sup> The army has chosen to further skew the concentration of Malays in the vital infantry units. This is accomplished through the Royal Malay Regiment.<sup>17</sup> This 100-percent Malay formation comprises 26 of the 37 infantry battalions.

The RMP shares internal security responsibilities with the MAF. With 60,000 personnel, the RMP is almost as large as the army. Like the MAF, the RMP is theoretically open to all races, but in practice Malays form the bulk of the personnel.<sup>18</sup> As a result of the 1969 riot, officials realized that police forces were insufficient to contain civil disturbances. A number of po-

lice units were expanded or their missions were focused on the potential security threat of interethnic rivalries. Two units affected were the Special Branch and Police Field Force (PFF), which is specially trained and equipped to conduct riot control and antiinsurgent operations. The PFF consists of 19,000

personnel in 21 battalions. The Special Branch is the country's principal security intelligence agency. Consequently, little is published about its organization or mission, but it is believed to concentrate on the internal security threat, particularly interethnic relations.<sup>19</sup>

Since the Vietnamese invasion of Cambodia in 1978, Malaysia has concentrated more of its time and resources into forming a credible external military capability. The transition to a more externally oriented defense posture includes the purchase of modern aircraft and naval vessels.<sup>20</sup> The new policy nuance was best expressed by Malaysia's defense minister, Datuk Sri Hj Mohd Najib Bin Tun Abdul Razak:

"As we all know since 1948, with the declaration of the Emergency, Malaysia has been fighting a CIW [counterinsurgency warfare] against the communists. It was very recently, in December 1989, that we could proudly say that we have finally won this long struggle against an alien ideology. As a result of the long years of involvement in internal war, the MAF had quite rightly, not concentrated on conventional warfare. Malaysia could not afford to have a two-structured military force. Today, with the com-

munist threat being put on hold indefinitely, we could fully concentrate on developing a conventional force without at the same time, forgetting nor neglecting our expertise in counterinsurgency operations. Our current defense modernization is based on this premise."<sup>21</sup>

With the internal protection of its citizens in mind, the Malaysian military began preparing for conventional war. Although the growth of Malaysia's conventional capability originated from concern over Vietnam, it reflects a growing anxiety about Singapore's large and capable military.

**Singapore.** During the transitions of the 1950s and 1960s, Singapore also experienced a few racial disturbances. Like Malaysia, Singapore joined the FPDA to benefit from the external protection the agreement provided. Unlike Malaysia, Singapore did not attempt to resolve its internal ethnic problems by force under the shield of the FPDA. To the contrary, Singapore sought to co-opt all of its citizens into the country's defense. Singapore decided that the most economical way for a small country to build an effective military and conduct "nation building" at the same time was through universal national service applied to all citizens, regardless of race.<sup>22</sup>

Consequently, Singaporeans do not have a professional volunteer force modeled after the British. Singapore's army consists of a small number of professional cadre. Its units are manned by national servicemen and reserves through a system of universal conscription of all Singaporean males. This system is similar to that of the Israeli army, upon which it is modeled.

Today, Singapore's security policy is built on a concept known as "total defense." Total defense has five aspects, only one of which is military. The other four dimensions are psychological, social, economic and civil defense. This article discusses only the social and military aspects of Singapore's defense concept.

Social defense addresses the ethnic division in Singapore. In the words of the Ministry of Defense Public Affairs Department:

"Singapore is a multi-racial, multi-cultural, and multi-religious society. The aggressor can exploit social differences to fuel ethnic unrest and incite religious intolerance. As such, Singaporeans must be determined to stay as one

people through thick and thin. There must be unity despite the diversity."<sup>23</sup>

This statement can easily be overlooked as propaganda, but its significance lies in the fact that race is in fact addressed, although in an inclusive manner. This is in contrast to Malaysia, which makes no such statement in its defense policies.

The decision to use the military and national service as a tool to involve all young men in the development of the country has several benefits. First, it permits the mobilization of all eligible young men. In a small country every soldier is

---

*The Malaysian government identifies itself with the Malay community. The Chinese and Indian communities are viewed as alien elements in society. The Chinese and Indian minorities have not taken the alien status sitting down. . . . Riots and insurrections have been their response. Thus Malaysia's defense policies have concentrated on the internal threat as the greatest danger to Malaysia's security.*

---

needed. National service also contributes to Singapore's goal of creating a Singaporean identity as opposed to a Chinese, Indian or Malay identity, thus easing intercommunal tensions. Reduced racial tensions allowed Singapore to concentrate on creating a credible external defense.

The indivisibility of Malaysia's and Singapore's defenses, formalized in the separation agreement in 1965 and in the FPDA, has a meaning for Singapore not necessarily intended by the other signatory powers.<sup>24</sup> History has taught Singapore the lesson of geographic vulnerability, especially from the north. Singapore's tiny size—only 230 square miles—makes it extremely vulnerable to a land attack. Its seaward defenses are, of course, extremely important, especially for a trading country, but navies are vulnerable to land-based antiship systems such as air-raft, rockets and artillery. The Japanese realized this and, in 1942, chose to

---

*Like Malaysia, Singapore joined the FPDA to benefit from the external protection the agreement provided. Unlike Malaysia . . . Singapore sought to co-opt all of its citizens into the country's defense. Singapore decided that the most economical way for a small country to build an effective military and conduct "nation building" at the same time was through universal national service applied to all citizens, regardless of race.*

---

take Singapore from the landward side.

The distance across the Johore Strait is only a mile. A potential aggressor could shoot artillery from across the Johore Strait and hit a target almost anywhere in Singapore.<sup>25</sup> For Singapore this means that any potential hostile power, Malaysian or others, in control of the Malay Peninsula could militarily influence Singapore.

In its early history, Singapore experienced significant security threats from Malaysian instability in the north and from Indonesia's *Konfrontasi* in the south. During the 1970s, through the Association of Southeast Asian Nations (ASEAN) and the FPDA, Singapore and Malaysia managed to develop a limited dialogue, although Singapore's threat from the north did not diminish. During this time, the Vietnam War escalated, and as a result of political decision following the 1968 Tet offensive, the United States eventually withdrew from Vietnam. By 1975, communist North Vietnam had taken over Vietnam. In December 1978, the Vietnamese invaded Cambodia, and for the countries of ASEAN, the worst predictions of the "Domino Theory" seemed to be coming true.

Malaysia and Indonesia now appeared weak to Singapore in comparison to the Vietnamese juggernaut. Singapore envisioned a scenario in which the Vietnamese occupied the Malay Peninsula and could reach Singapore by land.<sup>26</sup>

In the 1981 Singapore Ministry of Defense publication *The Singapore Armed Forces*, Robert Chew discussed ASEAN's options in light of Vietnam's usurpation of the role of regional power. Indonesia had been posed as a possible

ASEAN rival to Vietnam. Chew dismissed this saying, "It [Indonesia] lacks the kind of internal political discipline that would support a re-allocation of scarce resources away from economic development towards regional domination."<sup>27</sup> Singapore realized from the US withdrawal from Vietnam that it could not depend on any one power and had to be able to present a sufficient defense that compels an aggressor to take sizable risk in attacking.<sup>28</sup>

In August 1992, the Singapore Ministry of Defence Public Affairs Department published *Defence of Singapore, 1992-1993*. The preface begins with a statement concerning Iraq's invasion of Kuwait: "Therein lies an important lesson for Singapore. It reinforces our belief that a credible defence is the bedrock of a credible deterrence."<sup>29</sup> Thus for Singapore, the lesson from Iraq's invasion of Kuwait was not that Iraq was severely punished for its adventurism, nor that the United States and the UN would go to great lengths to protect the sovereignty of even the smallest countries. The lesson learned was that small countries must maintain a defense strong enough to deter or even destroy potential aggressors. Later in the volume, the mission of the Singapore Armed Forces (SAF) is declared, "If deterrence fails, the SAF is to secure a swift and decisive victory over the aggressor."<sup>30</sup>

Since its humble beginnings in 1965, Singapore has developed one of the most sophisticated and powerful militaries in Southeast Asia. An important aspect of Singapore's military is its aim. Important clues to its aim can be found in the organization, equipment and training of its military. Singapore's military is prepared to conduct extensive operations on the Malay Peninsula with or without the permission of the Malaysian government.

Singapore's main fighting force is its reserves, who number 250,000. This is in addition to the 50,000 regulars and national servicemen.<sup>31</sup> Among the three services, the army is the largest with 45,000 active duty and 170,000 reservists. The army is organized into five divisions, three of which Singapore calls "combined arms divisions."<sup>32</sup> The other units and the People's Defense Force are equipped at lower levels and are presumably to be positioned in less threat-

ened areas, thus allowing the army to concentrate its best units at critical areas of defense or maneuver in the attack.<sup>33</sup>

The combined arms divisions consist of four brigades, two of which have three infantry battalions each. One brigade is airmobile with three infantry battalions each. The fourth brigade is armored, consisting of two armored infantry battalions and a tank battalion. The divisions are also generously equipped with combat support and service support units such as artillery, engineers and supply.<sup>34</sup>

The significance of these units is their size and sophistication in comparison to Malaysia's army. In pure numbers, Singapore's army alone can muster 215,000 soldiers, almost twice that of Malaysia's possible 115,000. Also of note is Singapore's sophistication in comparison to Malaysia. Looking at only one type of equipment tanks—Singapore has 350 AMX 13 tanks, the largest fleet of that model in the world, and an estimated 63 Centurion Main Battle Tanks.<sup>35</sup> Malaysia possesses no tanks—only armored cars and armored personnel carriers.<sup>36</sup> This disparity in conventional warfare capability can be found in many other types of equipment as well.

Simply having a larger and better equipped army is not an indicator of intent. An overlooked facet of military equipment purchases is logistic equipment. Singapore's military has purchased or produced significant numbers of amphibious vehicles and a broad range of bridging equipment. Singapore's equipment purchases include amphibious cargo carriers, bridging boats, line of communications bridges, mechanized bridges, tactical floating bridges and ferries.<sup>37</sup> Additionally, much of its combat equipment is amphibious.<sup>38</sup> This type of equipment would be very useful in forcing a crossing of the Johore Strait and maneuvering units on the Malay Peninsula.

Another indicator of intent is training. A commander's goal is to train his unit under conditions as close to those expected in combat as possible. If the military is expected to fight in Singapore, then urban warfare would appear to be the most important training priority. However, Singapore provides substantial training for its military outside of Singapore in conditions quite different than urban terrain. This includes

armor crew training and maneuvers on a base in southern Taiwan and at a jungle warfare training center in Brunei. Both of these sites are permanent facilities. Other nonpermanent but regular training exercises are conducted in the Philippines, Thailand, Australia and New Zealand.<sup>39</sup>

---

*In August 1992, the Singapore Ministry of Defence Public Affairs Department published Defence of Singapore, 1992–1993. The preface begins with a statement concerning Iraq's invasion of Kuwait: "Therein lies an important lesson for Singapore. It reinforces our belief that a credible defen[s]e is the bedrock of a credible deterrence." Thus for Singapore, the lesson . . . learned was that small countries must maintain a defense strong enough to deter or even destroy potential aggressors.*

---

These efforts suggest that Singapore intends to fight outside its borders in areas with sufficient space for maneuvering tanks and with extensive jungles, such as the Malay Peninsula.

The Republic of Singapore Navy (RSN) plays a vital role in any defense concept. The importance of open sea lanes to Singapore is obvious. RSN's missile corvettes and fast attack craft stand as an effective deterrent and would be a valuable asset to regional or extraregional efforts to maintain the sea lines of communication in the South China Sea and through the Straits of Malacca.<sup>40</sup>

More interesting to this study is the RSN's considerable amphibious capability. *Jane's Weapons Systems 1988–1989* shows seven different types of amphibious craft.<sup>41</sup> One vessel, the landing craft vehicle, personnel, or LCVP, can carry approximately 20 to 30 people. The RSN possesses more than 100 of these vessels which are backed up by hundreds of other vessels. Four types can carry tanks and other vehicles. No other ASEAN navy possesses an equal amphibious capability. This extraordinary amphibious capability, coupled with the extensive over-water logistic and fighting capability

of the army, would greatly facilitate a forced crossing of the Johore Strait and extended operations on peninsular Malaysia.

The Republic of Singapore Air Force (RSAF) has not been neglected in Singapore's defense development either. The RSAF is the best equipped and trained air force in ASEAN.<sup>42</sup> *Jane's* provides a concise narrative on Singapore's capability:

"The island is protected by three layers of surface-to-air missile air defense, consisting of Bloodhound 2, Rapier, Improved Hawk and RBS-70 systems. In line with Singapore's doctrine of the deterrence of threats through the

---

*The Singapore government protests the violence and demands protection for lives and property of the Malaysian minorities. The Malaysian government, seeking to distract the attention the world has now focused on its country, accuses Singapore of interfering in Malaysia's internal affairs and claims Singapore is aggravating the situation.*

---

maintenance of a pre-emptive strike capability, the country has a strong air force equipped with F-5E fighter and A-4 attack aircraft. The latter force is being reengined and equipped with Maverick air-to-surface missiles, with its range considerably extended by the conversion of four C-130s to in-flight refueling tankers."<sup>43</sup>

Since 1989, Singapore has purchased American F-16s and continues to upgrade its ability to conduct pre-emptive strikes. The importance here is that the country which possesses this capability also gets to define "pre-emptive."

As with the RSN, the RSAF possesses considerable transport capability for army support beyond Singapore's borders. This includes, Skyvan C-130 transports transports and numerous helicopters to support the army's airmobile, parachute and commando forces. Additionally, the air force operates four E-2C airborne early warning aircraft.<sup>44</sup> These aircraft extend Singapore's electronic eyes far beyond its land-based radar systems. This is an invaluable asset for the air force

and the navy and increases Singapore's capability to conduct pre-emptive strikes. The SAI has comprehensively integrated the capabilities of all its services to accomplish even the most ambitious military operations on the Malay Peninsula.

## A Scenario for War

Two examples of ethnic clashes—those in Armenia and the former Yugoslavia—can aid in understanding the potential conflict between Singapore and Malaysia. In both Armenia and Yugoslavia, strong states came to the "rescue" of persecuted ethnic kin in neighboring states. In their volume, *Ethnic Conflict in International Relations*, Surhke and Noble wrote, "An ethnically pure strategy would be followed only when kin elsewhere control significant resources."<sup>45</sup>

Since 1970 Malaysia's ethnic groups have lived in remarkable harmony. Rapid economic growth and policies, such as the NEP, have temporarily tamed the ethnic passions. But that does not mean racial tension has disappeared. Donald Horowitz said "In severely divided societies—the Lebanese, Malaysias, and Nigerias of the world— it is not possible to obliterate those tensions —that is fanciful — and it is even more fanciful to pretend they are not there."<sup>46</sup>

The riot in Malaysia on 13 May 1969 did not result in an ethnic war like the Armenian and Yugoslavian conflicts for two reasons. First, the Malays were in firm control of the levers of power in the government and military, preventing non-Malays from gathering sufficient strength to escalate the riot into a civil war. Second, the non-Malays lacked a strong ethnic patron in a neighboring state to come to their rescue.

Since 1969, the situation concerning the special status of Malays and the second class citizenship of the non-Malays has not significantly changed in Malaysia. The NEP benefited only a few privileged Malays and failed to improve the economic well being of the vast majority of Malays.<sup>47</sup> In his article, Horowitz writes, "The symbolic side of the conflict is prevalent, and it is not amenable to the manipulation of material benefits that so often constitute the stuff of modern policy making."<sup>48</sup> The only way for most Malays to leave their traditional farming existence is through jobs in civil service or the army. Consequently, their special status in relation to

those jobs is as important to the Malays now as it was in 1969, and the laws protecting them have become, if anything, more stern.

The relevance of the Armenia and Yugoslavia examples becomes clearer in the nature of the changes in Singapore since 1969. In an attempt to overcome the restraints of its small domestic market, Singapore has invested heavily in Malaysia. This investment has grown quite substantially, and 50,000 visitors and 18,000 vehicles cross the causeway linking Malaysia and Singapore every day.<sup>49</sup> Singapore now controls substantial economic, political and military power. In addition, Singapore has already identified peninsular Malaysia as a possible threat to its security and has developed its military to counter that threat.

One thing that remains constant is the family ties between Singapore and Malaysia. I traveled in Malaysia in June 1989 during the Singapore school break. The planes, trains and buses were crowded with Singaporeans on vacation. Many of them were going to Malaysia to visit relatives. Throughout Malaysia, I frequently met Malaysian Chinese who had relatives in Singapore. Consequently, Singaporeans are concerned not only with their country's economic relationship with Malaysia but also with the conditions under which their relatives live. Economic interests, ethnic identification and close family ties give Singapore considerable qualifications as an ethnic patron to Malaysia's Chinese and Indian minorities.

Currently, Malaysia enjoys a political stability owed to the multiethnic nature of the dominant Alliance party in the Malaysian government.<sup>50</sup> However, as in 1969, a shift in the vote away from the center toward the ethnic-based parties on either side could result in renewed ethnic conflict and a spiral of violence.

The scenario for war is easy enough to imagine. It may start with Islamic political parties making big gains in national elections. The prime minister would be forced to make concession to maintain his position. Already alienated non—Malays protest, sparking mass arrests under the draconian laws available to the government under the Internal Security Act. The now desperate minorities become rioters. The Malaysian army is called in to restore order, but



*[An] indicator of intent is training. A commander's goal is to train his unit under conditions as close to those expected in combat as possible. If the military is expected to fight in Singapore, then urban warfare would appear to be the most important training priority.*

because they are mostly Malay, they have very little sympathy for the protesters and the riot control measures produce heavy casualties. Across the causeway in Singapore, the friends and families of the protesters are demanding action by the government. The Singapore government protests the violence and demands protection for lives and property of the Malaysian minorities. The Malaysian government, seeking to distract the attention the world has now focused on its country, accuses Singapore of interfering in Malaysia's internal affairs and claims Singapore is aggravating the situation. Malaysia also stops vehicular traffic across the causeway and threatens to redeploy the army to the Johore Strait to stop the infiltration of Singapore fifth columnists.

The stage is now set for a decision by the Singapore government. If it waits, and the Malaysian army successfully redeploys to the Johore Strait, the Singapore military could be trapped on the island. The air force and naval bases would be exposed to artillery and rocket fire, and a forcing of the crossing would be difficult

even against a numerically weaker enemy. In a short time, Singapore's economy would begin rapidly declining, available water and food supplies would be short and Singapore would be forced to seek a settlement on Malaysia's terms.

However, if Singapore initiates the conflict without further overt actions on the part of Malaysia, the military operations have a good chance for success. Not only would the Malaysian army be deployed against rioters instead of defending the Strait, but the Malaysian military would be divided between East and West Malaysia. The SAF does not need to capture East Malaysia to conduct a successful campaign. With its superior air and naval forces, it could prevent the movement of troops across the South China Sea.

As described above, the SAF already possesses the amphibious and engineering capability required to force a crossing of the Johore Strait. Moreover, once across, the army already

possesses the tanks, artillery, equipment and training necessary to conduct a successful campaign on the peninsula. The government of Malaysia would be forced to surrender or flee within days of the crossing.

Singapore's military has created an integrated and powerful force capable of leaping the Johore Straits and defending Singapore's interests on foreign soil. The above-described Singapore defense trends do not represent an evil conspiracy to dominate its neighbors or an attempt to establish hegemony in the region. Singapore's defense policies are the result of sober and thorough consideration of its history, geography, economy and the social tensions in its society. Through ASEAN, the FPDA and other confidence-building measures, tensions in the region have been reduced considerably since 1969. Unfortunately, Singapore's strengths and Malaysia's weaknesses can still become a source of conflict. *MR*

#### NOTES

1. *Malaysia a Country Study*, edited by Fredrick M. Burgo (Washington, DC: US Government Printing Office [GPO], 1984), 69.
2. *Singapore a Country Study*, edited by Nena Vreotank, Glenn B. Dana, Geoffrey D. Hurwitz, Peter Just and H.S. Shinn (Washington, DC: US GPO, 1987), viii.
3. *Malaysia*, 53.
4. Steve Chan, *East Asian Dynamism: Growth, Order, and Security in the Pacific Region* (Boulder, CO: Westview Press Inc., 1993), 103-6.
5. Jeshun Chandran, *Malaysian Defense Policy: A Study in Parliamentary Attitudes 1963-1973* (Penarbit University Malaya, 1980), 66.
6. Kin Wah Chin, *The Defense of Malaysia and Singapore: The Transformation of a Security System 1957-1971* (Cambridge University Press, 1983), 166.
7. Leon Comber, *13 May 1969: A Historical Survey of Sino-Malay Relations* (Heinemann, Asia, 1983), 65, 70.
8. Chin, 138.
9. Chin, 141-42.
10. Chin, 144-78.
11. Chin, 193.
12. Chin, 188.
13. *Malaysia*, xxi.
14. *Malaysia*, 260.
15. *Malaysia*, 259-69.
16. *Malaysia*, 267.
17. *Chandric*, 52.
18. *Malaysia*, 281.
19. *Malaysia*, 273-81.
20. MAJ(R) R. Sachi thanathan, "The Malaysian Armed Forces - Role in National Defence," *Asian Defence Journal* (October 1990): 12-31.
21. Datuk Sri Hj Mohd Najib Bin Tun Abdul Razak, "Malaysia's Strategic Perceptions: Challenges of the Post Cold War Era," *Asian Defence Journal* (February 1993): 6-13.
22. *Singapore*, 141.
23. Ministry of Defence Public Affairs Department, "The Singapore Armed Forces" (Singapore, 1992), 13.

24. Chin, 166.
25. *Jane's Armour and Artillery, 1992-1993*, edited by Christopher F. Foss (Alexandria, VA, 1992).
26. *Ministry of Defence* (1981), 13.
27. *Ibid.*, 190.
28. *Ibid.*, 177-83.
29. *Ministry of Defence* (1992), 5.
30. *Ibid.*, 18.
31. *Ibid.*, 19.
32. *Ibid.*, 28.
33. R.S. Sassehen, "The Singapore Armed Forces: Geared for Total Defence," *Asian Defence Journal* (April 1989): 4-20.
34. Sassehen, 16.
35. *Jane's Armour and Artillery*, 177, 135.
36. *Ibid.*, 791.
37. *Jane's Military Vehicles and Logistics, 1993-1994*, edited by Christopher F. Foss and Terry J. Gander (Alexandria, VA, 1993), 117, 138, 156, 172, 534.
38. *Jane's Armour and Artillery*, 793.
39. Sassehen, 18.
40. *Ministry of Defence* (1992), 42.
41. *Jane's Fighting Ships, 1993-1994*, edited by CPT Richard Sharpe, RN (Alexandria, VA, 1993), 610-11.
42. Sassehen, 20.
43. *Jane's Weapon Systems, 1988-1989*, edited by Bernard Blake (Alexandria, VA, 1988), 30.
44. Sassehen, 14.
45. Astri Suthke and Lela Gamel Noble, *Ethnic Conflict in International Relations* (New York, NY: Praeger Publishers, 1977), 1-19.
46. Donald L. Horowitz, *Conflict and Peacemaking in Multiethnic Societies*, edited by Joseph V. Montville (Lexington Books, 1990), 115-30.
47. Chan, 99.
48. Horowitz, 115.
49. Chan, 123.
50. Horowitz, 451-76.

Major Dana R. Dillon is a project officer assigned to the Office of the Deputy Chief of Staff for Intelligence, The Pentagon, Washington, D.C. He received a B.S. from the University of Nebraska, an M.A. from the University of Wisconsin Madison and attended the National University of Singapore as a visiting fellow in the Institute of Southeast Asian Studies. He is a graduate of the US Army Combined Arms Service Staff School and the Defense Language Institute. He has served in a variety of command and staff positions in the Continental United States, Southeast Asia and Europe.



# Strategy for a Second Career

Major Mark C. Malham, US Army

*Changing careers can be an overwhelming experience. It requires patience, self-confidence and perseverance to succeed. A big challenge for military people transitioning to the private sector is explaining service experience in terms potential employers can understand. As the author suggests, the first step in planning a transition is to examine your job qualifications and educational background. Your military experience can be a big plus in the civilian world, but the key is knowing how to communicate it properly.*

**V**OLUNTARY SEPARATIONS, reduction-in-force boards and selective early retirement boards are common topics for discussion among commissioned officers today. Unfortunately, the ability to quickly transition from Army green to business grey is complicated by parallel drawdowns in the private sector. Officers who become entangled in the drawdown web must prepare themselves for the challenges of acquiring and maintaining civilian employment. So how does an officer who is contemplating either voluntary or involuntary separation compete for those diminishing jobs? While contemporary authors have published laundry lists on possible strategies, Sun Tzu, an ancient Chinese military strategist, cogently summed up the strategy when he stated, "*Know the enemy and know yourself.*"<sup>1</sup> I relate Sun Tzu's 2,300-year-old axiom to the marketability of Army officers today.

## Know the Enemy

While some may perceive *know the enemy* as adversarial, I view it as an invaluable tool for assessing the private sector's job market. *Know the enemy* relates to the hostile civilian environment awaiting the veteran officer as he searches for employment. Some of the issues that the

officer must be aware of include the economic conditions within the country and within the respective industry that he is seeking employment. For instance, an officer should consider how he can profit from the recently approved North American Free Trade Agreement. He should be aware of the industries that offer excellent job opportunities and the industries that are saturated with job applicants. An officer should also get to know the culture of the specific company he is seeking employment at, for not all companies have an "IBM culture." To better comprehend the enemy, let us take a look at current economic conditions.

Author Alvin Toffler categorized the evolution of man into three waves: the Agrarian Wave (8000 BC to 1700), the Industrial Revolution Wave (1700 to 1955) and the Information Wave (1955 to the present). Each wave resulted in economical, political and social changes. This article will focus on economic changes only. Every wave's economic changes catapulted man to a higher plateau, enabling him to become more efficient than his predecessors, thereby improving his standard of living. A byproduct is that each subsequent age resulted in structural



**According to an education survey, 95 percent of employers stated that American workers require higher education standards. Not only do employers acknowledge a lack of mathematical and communication skills in today's employees, but employers also acknowledge that their employees lack skills in such diverse areas as team building, proper grooming habits, respect for authority, discipline and an ability to learn new tasks.**

changes to the respective economy. These changes penalized those who were unable to adapt to the new age. One of the major changes that occurred was structural unemployment.

By definition, structural unemployment, which the US economy has been experiencing for the past several years, is more severe than other types of unemployment. Structural unemployment and the structural changes that are required to cure the ailment are resistant to short-term fixes. Tax cuts or heavy doses of government spending will not fix the problem; however, these remedies are often popular with politicians vying for reelection. Rather, the remedy usually involves a long-term, evolutionary approach to education. Education must target those in their formative years of schooling (grades 1 to 12) as well as those currently within the work force. Robert Hormats, former assistant secretary of state for economic and business affairs, underscored the importance of education when he wrote:

"Such success (Operation *Desert Storm*) was made possible by an underlying economy able to turn out great volumes of extremely advanced military equipment and software as well as men and women skilled in operating them. The US economy would not have been capable of doing this but for a history of high American savings and enormous investment in education, industry, science, technology and the infrastructure to link these elements together. Savings and investments of earlier years were not intended primarily to bolster America's capacity to send well-

equipped forces overseas, but they had the derivative effect of making that possible and, more generally, of strengthening the foundations of American global power—political and economic, as well as military."<sup>2</sup>

What are the sources of structural unemployment? I already mentioned one, a lack of education. The other is rapidly developing technology, often in the form of computers.

**Education.** By the year 2000, professional and managerial jobs are projected to increase by 6.7 million, while low-skill jobs are projected to increase by only 450,000. These changes emphasize the need for qualitative and quantitative improvements in education. Even though a high school diploma will remain the highest education level required for most jobs, its share of new jobs is projected to decrease by 12.5 percent (see fig. 1).<sup>3</sup> Jobs that require a college degree (16 years of schooling) or an advanced degree are projected to increase by 36.6 percent.

Our ability to compete globally dictates the need for changes in schools and work places. Measures are under way to address the needs of our children during their formative years of schooling. Then President George Bush, working with all 50 state governors, led by former Arkansas Governor Bill Clinton, approved *Goals 2000 Legislation*. This legislation, once approved by Congress, obligated almost a half-billion dollars to implement national education standards. Measures to address the needs of the work force are more elusive though; the private sector has only just begun to view employee training as an investment rather than an expense.

School Years	Current Jobs	New Jobs	Net Change
1 - 8	6%	3%	-50%
9 - 11	12%	10%	-16.67%
12	40%	35%	-12.5%
13 - 15	20%	22%	+10%
16+	22%	30%	+36.6%
Total	100%	100%	NA
Median Years	12.8	13.5	NA

Source: *Workforce 2000: Work and Workers for the Twenty-First Century*  
Figure 1. Education Levels for Occupations of the Future

According to an education survey, 95 percent of employers stated that American workers require higher education standards.<sup>4</sup> Not only do employers acknowledge a lack of mathematical and communication skills in today's employees, but employers also acknowledge that their employees lack skills in such diverse areas as team building, proper grooming habits, respect for authority, discipline and an ability to learn new tasks. The private sector realizes that it cannot rely solely on the education system to cure these deficiencies, so employers have become proactive in teaching their employees both specific skills (related to one job) and general skills (related to more than one job). This is important to note because in the past, employers focused almost exclusively on specific skills. Why the change of heart?

To explain this new philosophy, I will use a simple illustration. In the past, Company A was willing to train Employee A on tasks required to accomplish a specific job. Should Company A fire Employee A, or if Employee A quits, Company A would lose little. It would simply hire and train another employee and Employee A would have little to show when he sought other employment.

Company A can no longer afford this approach in today's highly competitive, global market place. Total quality management (TQM) is permeating the organization; management and labor understand that they are on the same team. Thus, today's workers offer more than an input to labor; they represent a pool of diverse and broadly talented assets. Now, Company A hires Employee A, trains him not only in tasks related to a specific job but also in general skills such as team building, decision making and the art of communication. Company A and Employee A realize the investment each has made in the other. Thus, Company A is less willing to release Employee A; in turn, Employee A is less willing to leave Company A.

This is not as idealistic as it may sound because Japanese companies have employed this philosophy for years. American companies such as General Motors Saturn division are just



Many ceremonies and traditions unique to the military are symbolic of the spirit, trust and confidence America places in its uniformed leaders and represent the nation's highest ideals, beliefs and traditions.

*As we evaluate ourselves, we initially perceive that employers value common traits we share collectively as officers: mission accomplishment with little or no guidance, discipline and integrity. Upon closer evaluation though, we realize that we are not all equal: education level, primary and alternate specialties and years of service influence an employer's perception.*

beginning to catch on having successfully instituted TQM.

**Technology.** Another cause of structural unemployment is rapidly evolving technology. As technology permeates our everyday lives at an exponential rate, it has a negative impact on employment. Tasks that used to require many workers can now be accomplished with fewer people. Consider the following comparisons of past and current outcomes in similar situations.

- Years ago if a company laid off large numbers of its employees, the company's stock price would normally decrease, for the layoff was an indication of hard times. Today, companies lay off large numbers of employees

---

**P**roductivity is important to an economy because it is the catalyst for increasing a country's standard of living. Thus, employers hope to achieve an average gain of 10 percent in productivity in good and bad economic times. While improving management operations and extending the work week are part of the answer to increased productivity, the biggest factor is rapidly evolving technology.

---

and their respective stock prices usually increase; Wall Street's reward for becoming more efficient!

- Years ago if a large number of workers lost their jobs, the result would be negative productivity. In 1993, 600,000 workers lost their jobs, yet productivity actually grew 1.6 percent.<sup>5</sup>

The reason these anomalies of yesteryear are becoming routine today is that there is no longer a positive correlation between the number of workers employed and productivity. Productivity is important to an economy because it is the catalyst for increasing a country's standard of living. Thus, employers hope to achieve an average gain of 10 percent in productivity in good and bad economic times.<sup>6</sup> While improving management operations and extending the work week are part of the answer to increased productivity, the biggest factor is rapidly evolving technology. Cutting-edge technology is replacing old forms of labor that required many employees to complete one task. Diverse, yet equally successful, examples of what some American companies are doing to improve productivity include the following:

- Expert systems, computer based software programs that mimic human reasoning, are employed in government and private sectors to accomplish a myriad of tasks ranging from launching the space shuttle to routing airlines to conducting vehicle maintenance.

- Executives draft their own documents using notebook computers instead of waiting hours for the typing pool. Additionally, on-line electronic

systems allow executives to query data bases that provide instantaneous access to information within the privacy of their offices.

- A major telephone company uses a computer system that monitors its fiber-optic cables around the clock. In the event of a disaster, the computer system automatically switches to a serviceable line.

- Apparel companies, often stereotyped as "sweatshops," now employ high-tech lasers and robots to cut and sew fabrics.

These sophisticated information systems are the foundation for diversified companies, providing corporate leaders instantaneous accesses to information they need to make quick and accurate sound decisions. As a result, the organization's hierarchy becomes flatter and more streamlined.

While technology often shares an inverse relationship with employment, it has not affected all workers evenly. In the past, blue collar workers were the casualties in corporate downsizing. If the manufacturing capacity utilization rate dropped, blue-collar workers were laid off until the rate increased. Currently, their unemployment rate is 9.1 percent, which is more than twice the rate for white collar workers.<sup>7</sup> Today white collar workers are the casualties, although this is debated by some.<sup>8</sup>

The reason for this change is that unlike blue collar workers, who are laid off during recessions and rehired during recoveries, white collar workers who are laid off usually never get their jobs back. As a result, permanent separations accounted for 85 percent of job losses in the last recession, compared with 56 percent in four previous recessions. Second, blue collar workers today are a minority in the American labor force. The white collar work force dominates the labor market, representing more than 6 of 10 workers.<sup>9</sup>

**Know Yourself.** We now come to the second half of Sun Tzu's axiom, *know yourself*. With a clearer understanding of what awaits us, we can better examine ourselves—our respective strengths and weaknesses, to help prepare for transition to the private sector.

As we evaluate ourselves, we initially perceive that employers value common traits we share collectively as officers: mission accomplishment with little or no guidance, discipline and integrity. Upon closer evaluation though, we realize that we are not all equal: education level, primary and alternate specialties and years of service influence an employer's perception. So who are potential winners and losers?

**Education Level.** With the US Military Academy (USMA) and Reserve Officers' Training Corps (ROTC) commissioning nearly 94 percent of all second lieutenants, and Officer Candidate School (OCS) commissioning the remaining 6 percent, OCS officers are at a disadvantage if they do not obtain their baccalaureate by the time they depart the service.<sup>10</sup> I state this for two reasons. First, unlike USMA and ROTC, OCS does not require a baccalaureate prior to commissioning, although the OCS officer is expected to obtain his degree as soon as possible. Second, the previously listed data reveal the importance of a college or advanced degree.

Another factor is that lieutenants and captains collectively have less than 15 percent of all commissioned officers' advanced degrees.<sup>11</sup> Granted, many prefer to concentrate their efforts on their platoons or companies and hope for the opportunity to obtain an advanced degree through the fully funded program at a later date. However, the drawdown has affected captains, and as the cuts become deeper and deeper, captains will continue to be placed at risk. Thus, it is imperative to maximize one's education prior to seeking employment in the private sector.

**Specialties.** Combat support (CS) and combat service support (CSS) officers usually fare better than those in combat arms because they offer employers general as well as specific skills.<sup>12</sup> Combat arms officers, on the other hand, only offer employers general skills gained from their military experience focused on warfighting skills, which have no parallel in the private sector. As mentioned earlier, employers usually value general skills over specific skills. Thus, depending upon the industry in which an officer is seeking employment, this may or may

Surviving the frenetic pace of tactical operations is one thing—explaining that experience in terms potential employers can understand is another.

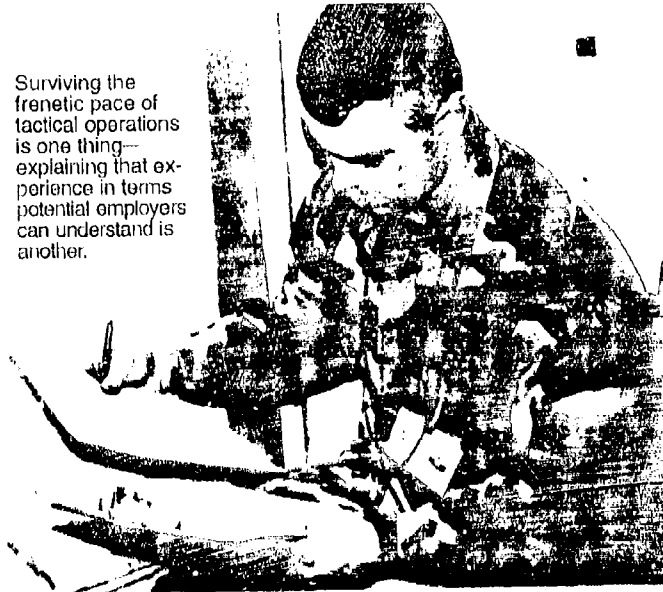

**CS and CSS officers** usually fare better than those in combat arms because they offer employers general as well as specific skills. Combat arms officers, on the other hand, only offer employers general skills gained from their military experience focused on warfighting skills, which have no parallel in the private sector. . . . Employers usually value general skills over specific skills.

not be relevant. For instance, a finance officer may have an advantage over an armor officer if both were applying to be a manager in an accounting firm. However, if these two officers were applying to be retail (or sales) managers, neither may have an advantage.

**Years of Service.** Through an informal survey of 22 employers in key gross national product (manufacturing, communications, retail, finance and other services) industries, the optimal number years of service for an officer to have prior to seeking employment in the private sector (using a weighted average method) is 3.61 years (see fig. 2). Note that employers responses ranged from 1 to 3 years to 8 to 11 years; however, not one employer responded

In the past, blue-collar workers were the casualties in corporate downsizing. If the manufacturing capacity utilization rate dropped, blue-collar workers were laid off until the rate increased. . . . Today white-collar workers are the casualties . . . unlike blue-collar workers, who are laid off during recessions and rehired during recoveries, white-collar workers who are laid off usually never get their jobs back.

that more than 12 years is optimal.<sup>13</sup> While this was an informal survey and the sample size was small, it correlates with the various "headhunters" philosophies that primarily target junior officers (lieutenants and captains) as potential employees.

The rationale is that employers appreciate the Army's approach to character building for its officers. This negates employer expenses to train basic skills. However, according to several independent studies, most officers become a liability to employers after eight years of military service. The reason is that the Army's socialization process, which established a solid foundation of general training skills within the first few years of service, becomes rigidly ingrained in an officer in subsequent years. Thus, a firm may have difficulty acclimating a veteran officer to its culture after more than eight years of military service.

What does this mean to the officer facing separation? We must ensure that we have a firm

Scale	Respondents	Weighted Average
1 - 3	13	26
4 - 7	8	44
8 - 11	1	9.5
12 - 15	0	0
16 - 19	0	0
20+	0	0
Total	22	79.5
Average	NA	3.61

Figure 2. Optimal Years of Service

mental grasp of *know the enemy and know yourself*. If education is going to dominate the 21st century and we lack a college or advanced degree, acquiring the degree should be a top priority for us. Remember, education is an asset, not a liability. Officers should check with their post Education Center to learn about educational opportunities within their immediate geographical area. Education counselors can help officers identify their goals, programs available and funding options.

If technology is going to dominate the 21st century, we need to market ourselves as prospective employees who are adaptable to the changing world. Keep in mind that while decision support systems are replacing mid-level managers, there will always be a need for managers who can interpret the data and then make the correct decision based upon the information at hand. To determine which employers you can best serve with your skills, contact the Army Career and Alumni Program (ACAP). ACAP has many tools to assist the transitioning officer through its unique data base, the Army Employer Network (AEN). AEN is a tool for matching the demands of employers with the supply of Army alumni and is a dynamic data base composed of both local and national employers.

As we closely evaluate our respective strengths and weaknesses, our education level and adaptability can be readily weighed. However, our specialty selection and years of service are harder to weigh because the vast majority of officers are committed to the profession of arms. While some believe that CS and CSS officers have an advantage over combat arms officers, I believe that it is an insignificant advantage. Officers are usually hired for their managerial and leadership (general) skills, not their technical (specific) skills. I do not think the evidence supports the notion that cadets should avoid warfighting branches, or that combat arms officers should request branch transfers.

So, we now are faced with the hardest decision: if and when to separate from the service. If it is involuntary separation, the decision is made for us. If, on the other hand, it is voluntary

separation, the decision is harder to make. We may want to postpone the decision indefinitely, however; separation pay, based on involuntary separation, is significantly less than the Voluntary Incentive Separation Program (VIS/SSB) that one receives if eligible to volunteer for separation. Family considerations play a major role in deciding what to do. Thus, bringing our spouses into the decision-making cycle is important. Second, review your officer efficiency reports. Be candid with yourself. Then seek out your senior rater's advice based upon your current performance and career potential. Also, take advantage of your branch manager's expertise. He has access to many of your peers' profiles and can advise you accordingly. Keep in mind that if you want to separate from the service, the 3- to 6-year mark is the optimal time to separate. Beyond that, the theory of diminishing returns lessens your chance of being hired by a civilian employer.

Regardless of whether we serve for three years or 30, officers should take counsel that as professionals, we have great pride in ourselves, our country and the men and women we lead. No one can grasp the depth of our conviction unless he or she has served in the military. However, one researcher has come close to accurately expressing what so many of us feel in our hearts:

"The character of military leaders which transcends economic, political and sociological pressures is expressed in dedicated service to the

**A**s we closely evaluate our respective strengths and weaknesses, our education level and adaptability can be readily weighed. . . . While some believe that CS and CSS officers have an advantage over combat arms officers, I believe that it is an insignificant advantage. Officers are usually hired for their managerial and leadership (general) skills, not their technical (specific) skills.

country based on the principles of duty, honor, country. I submit that few men, not early inculcated with these ideals and who have not lived their whole productive life in their expression, can learn, completely understand, or even comprehend this ideology which is the source of strength for the military leader in formulating his convictions and making his decisions. The military commander, who by this inner strength stands with clear conscience before his Maker and makes the decision to take away the most precious element in all the world—life—from his fellow man, can with understanding and unadulterated determination make the critical decisions on national security policy on which his nation's life depends. *The greatest captain of industry can be but a comparative novice in this soul-searching undertaking.*<sup>14</sup> MR

NOTES

1. Sun Tzu, *The Art of War* (London: Oxford University Press, 1963), 84.  
 2. R.D. Hormats, "The Roots of American Power," *Foreign Affairs*, 70(3)1991:132.  
 3. W.B. Johnston and A.E. Packer, *Workforce 2000: Work and Workers for the Twenty-first Century* (Indianapolis, IN: Hudson Institute, 1987).  
 4. L. Harris and R.F. Wagner, *An Assessment of American Education: The View of Employers, Higher Educators, The Public, Recent Students, and Their Parents* (New York: Louis Harris & Associates, 1991).  
 5. G. Lewthwaite, "Making More with Less," *The Baltimore Sun*, 13 February 1994:D1.  
 6. L. Grant, "New Jewel in the Crown," *U.S. News & World Report*, 116(8) 1994:55.  
 7. D. Hage, L. Grant and J. Impoco, "White-Collar Wasteland," *U.S. News & World Report*, 114(25)1993:44.

8. For further discussion, see Robert Z. Lawrence's essay, "Rude Awakening: The End of the American Dream," *International Economic Insight* (January/February 1994).  
 9. Hage, Grant and Impoco, 44.  
 10. Department of Defense, *Defense 93* (Alexandria, VA: American Forces Information Services, 1993), 2.  
 11. Department of the Army Officer Personnel Management Directorate provided these statistics telephonically, 1992.  
 12. G. Calofio, "The Military Profession: Theories of Change," *Armed Forces and Society*, 15(1)1988:58.  
 13. For further discussion, see CPT Malham's report *The Marketability of Army Officers*, University of Texas at El Paso, 1992.  
 14. M. Janowitz, *The Professional Soldier: A Social and Political Portrait* (New York: Free Press, 1971), 231.

Major Mark C. Malham is a project officer assigned to the Directorate of Combat Developments, US Army Armor Center and School. He received a B.S. from the University of Illinois and an M.B.A. from the University of Texas - El Paso. He is a graduate of the US Army Command and General Staff College. He has served in a variety of command and staff positions in the Continental United States and Europe.

## A Corridor to Nowhere

Lawrence Massengill

In the final autumn of World War II, as the battle for Europe approached its crescendo, Allied airborne and armored forces launched one of the most daring and spectacular assaults of the entire conflict. Code-named Operation *Market Garden*, it was British Field Marshal Sir Bernard L. Montgomery's bold plan to seize a series of vital Rhine River bridges and pave the way for a massive assault into northern Germany.

*Market Garden's* size and scope were without equal. An entire parachute and glider-borne army would be dropped into Holland, opening a route for an armored dash to the Rhine. The plan's audacity and the courage of US, British and Polish soldiers who battled for *Market Garden's* prizes—the key bridges and highways—produced a unique and enduring chapter in the history of warfare.

Perhaps the most fascinating and baffling aspect of the operation is that Montgomery, who had consistently advocated cautious and conservative strategies, devised a plan that was neither cautious nor conservative in any sense. What drove this complex leader to abandon his careful, career-long style in favor of such a daring stroke remains an elusive puzzle, even with the passage of time.

*Market Garden* stemmed from the Allies' frustration with the stalemate that was developing on the battlefield. As the summer of 1944 drew to a close, the advancing armies of Supreme Commander General Dwight D. Eisenhower had ground to a reluctant halt. After finally breaking out of their Normandy Beachheads, Allied forces had smashed the German resistance, inflicted more than 400,000 enemy casualties and overrun most of France and Belgium. Yet, as they neared the Dutch and German borders, logistic problems became acute. The vast quantities of ammunition, gasoline and other war materiel strained the limited facilities of channel ports, overwhelmed the road and rail network and eventually stopped the rapid advance.

Montgomery's 21st Army Group finally halted near the Belgian-Dutch border. Although the supply system was clearly inadequate for the combined needs of Montgomery's forces and those of Lieutenant General Omar N. Bradley's 12th Army Group, Montgomery contended there was ample capacity to sus-

tain his own forces for a drive into northern Germany.

But Eisenhower, favoring a broad advance along a front stretching from Switzerland to the North Sea, vetoed Montgomery's plan. He believed Montgomery would be forced to steadily deplete his attacking force to protect its own flanks, inviting the thrust to be overwhelmed. Yet, Montgomery insisted his armies could outflank the Siegfried Line, smash through Germany's vital Ruhr Valley and dash into Berlin. Reflecting his admiration of Sir B. H. Liddell Hart, Montgomery's plan shared the British military theorist's advocacy of unlimited objectives and psychological damage to the enemy from deep penetration by armored forces.

But repeated attempts to convince Eisenhower failed, and the single-thrust versus broad-front controversy became an acrimonious issue that threatened the unity of the Allied command. Finally, the two leaders reached a compromise, and Montgomery proposed a far more limited plan. *Market Garden* was the result.

The large-scale airborne and armored assault would secure a corridor through Holland and position the 21st Army Group for a massive push across the Rhine. But it seemed certain that the canny Montgomery had not abandoned his ambitious aims but had only substituted a more modest set of initial objectives that Eisenhower would accept. After *Market Garden*, he would force through his original plan for a full-scale offensive.

Eisenhower, who had already placed Lieutenant General Lewis H. Brereton's First Allied Airborne Army under Montgomery's command, quickly approved *Market Garden's* "limited" goals. Some 35,000 men of the crack 82d and 101st Airborne divisions, the British 1st Airborne Division and the Polish 1st Parachute Brigade would be used in one of the boldest—some say reckless—operations of the war.

*Market Garden's* objectives included a surprise assault by a massive parachute and glider-borne force and the seizure of a series of key bridges and the major highway artery that ran northward from Belgium through Eindhoven and Nijmegen to Arnhem on the Dutch-German border. With the route secured, British Lieutenant General Brian G. Horrocks's XXX Armored Corps would dash across



Holland, outflank the Siegfried Line and open the door to northern Germany. *Market Garden* would also neutralize the V-2 rocket sites in western Holland and trap the Fifteenth German Army, which had withdrawn from Belgium.

Uncharacteristic of Montgomery, the plan was extremely complex and left little margin for mishap. Its success hinged on the assumption that German resistance would be weak and the premise that all bridges could be taken intact. If even a single bridge was lost, the entire operation would fail.

Success also demanded split-second timing, accurate emplacement of all airborne forces and faultless battlefield coordination. Finally, *Market Garden* would depend on the speed with which the armored columns could traverse the 64-mile highway corridor and reach the last bridge at Arnhem. Airborne forces, even if they succeeded in seizing the vital span, could not resist a determined counterattack for more than a few days. Relief would be critical.

*Market Garden*, launched 17 September 1944, began to unravel almost immediately. Enemy action and accidents destroyed many transport aircraft en route, and a large number of troops were landed in the wrong zones—some virtually on top of the 9th and 10th SS divisions. Forces became isolated, and

radio failures caused a near-total breakdown in communications. Finally, a turn of bad weather halted the flow of badly needed reinforcements and supplies and deprived the embattled Allied forces of effective air cover.

Contrary to the overly optimistic initial intelligence estimates, both the quantity and quality of German defenders were quite high. The battle-hardened II SS *Panzer* Corps, heavily invested with armor and artillery, quickly confronted the attackers. British armored columns made agonizingly slow progress as they battled for every precious yard along the single, narrow highway toward Arnhem. Their anticipated dash became a crawl.

Finally, though most of *Market Garden's* initial objectives had been gained, a battalion of the fragmented British 1st Airborne Division was forced to yield the bridge at Arnhem. Overcoming stubborn resistance by the vastly outnumbered "Red Devils," SS units succeeded in regaining the span after nine days of intense fighting that some German survivors, veterans of the Eastern Front, called the most vicious of the war.

Without the Arnhem bridge, *Market Garden* could not succeed. Despite heroic performances by the Americans at Son and Nijmegen, the British and



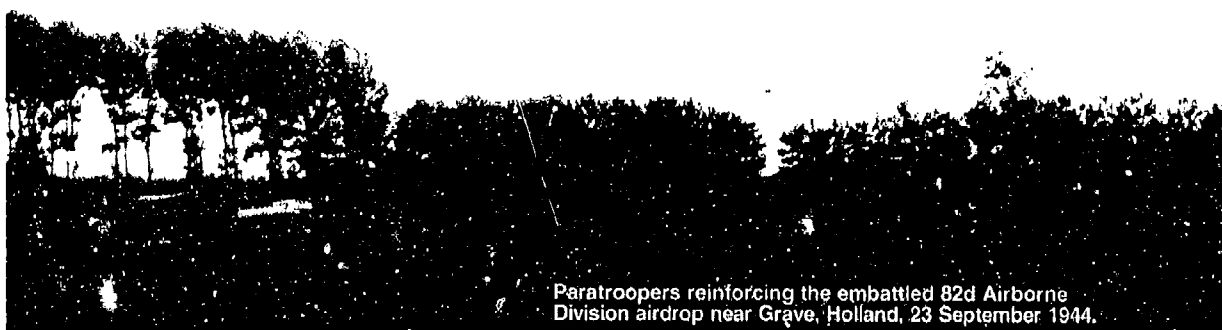

Paratroopers reinforcing the embattled 82d Airborne Division airdrop near Grave, Holland, 23 September 1944.

the Poles at Arnhem and the tankers who had battled their way along the besieged corridor, *Market Garden* had become a frustrating and expensive failure. Eisenhower, writing later in his book *Crusade in Europe*, termed it a "partial success," but nothing could obscure the fact that there were 17,000 Allied casualties, greater than the losses on D-day. *Market Garden* had gained nothing more than a "50-mile salient leading nowhere," as John C. Warren says in *Airborne Operations in World War II: European Theater*.

There remains, to this day, much disagreement over the soundness of Montgomery's *Market Garden* plan. Citing its tragic failure, most historians hold the view that it was faulty in concept, as well as in execution. Among Montgomery's harshest critics was Bradley. In his book *A General's Life*, written with Clay Blair, the former commander of the US 12th Army Group contends *Market Garden* was "dangerously foolhardy—the wrong plan at the wrong time and in the wrong place."

Yet, to say that *Market Garden's* concept was inherently flawed is to ignore a substantial body of contrary opinion. Interrogated after the war, Major General Günther Blumentritt, former German chief of staff, West, endorsed Montgomery's basic strategy for an attack on the Ruhr. Blumentritt said, "He who holds Northern Germany holds Germany. Such a breakthrough, coupled with air domination, would have torn in pieces the weak German front and ended the war." Blumentritt's assessment of German weakness was shared by the Combined Allied Intelligence Committee in London, which also believed the

enemy to be incapable of serious resistance.

Given the severe logistic problems confronting the Allied armies in the late summer of 1944 and the still formidable defenses of the Siegfried Line, it can be argued that *Market Garden*, despite its enormous complexity and risk, may have represented the best opportunity to smash into the German heartland and end the war before winter.

If Montgomery's decision is to be judged fairly, nearly 50 years later, it is necessary to assess its possible impact on the course of the war had the assault succeeded. Had *Market Garden* accomplished its operational objectives, a major thrust across the Rhine by Montgomery's entire 21st Army Group could have followed. Despite Eisenhower's misgivings about the risk of such an attack, Blumentritt was far less sanguine about the ability of German forces to withstand an assault.

There is room to argue that a powerful thrust into northern Germany in the fall of 1944 could have overrun the Ruhr Valley, driven into Berlin and forced a Nazi surrender by the end of the year. Had this occurred, it is unlikely Germany could have mounted its powerful December offensive through the Ardennes Forest. The Battle of the Bulge would have been averted and the heavy casualties during the war's final winter greatly reduced. British and US forces could have been first to occupy the German capital, an event that might have drastically revised the postwar map of Europe and avoided decades of Cold War confrontation. Such was the potential windfall of *Market Garden*—had the ill-fated operation been successful.



But any objective assessment must recognize *Market Garden* was a failure and that it had major consequences on the remaining course of the war. The assault had the immediate effect of drawing the enemy, in full force, to Montgomery's front, and the Germans continued to offer powerful resistance in that critical northern sector during the remainder of 1944.

From a logistic point of view, *Market Garden*'s massive buildup only worsened the already serious supply problem along the Allied front. Bradley's powerful 12th Army Group was deprived of critical support that could have enabled the Americans to maintain pressure on the Siegfried Line and the Saar and strengthen their position from which to mount the final assault. Additionally, *Market Garden* further delayed clearing German forces from the Schelde Estuary and postponed until November opening the critically needed port of Antwerp through which supplies for the final drive into Germany would flow.

In the end, *Market Garden* proved to be a wasteful use of scarce resources that seriously impeded Eisenhower's broad-front strategy. Its failure detracted from the overall conduct of the war and ended any hope of defeating Germany in 1944.

Analyzing the circumstances and events that culminated in *Market Garden*, Montgomery's uncommon boldness may be the most difficult of all to understand. At El Alamein in 1941, where he vastly outnumbered Field Marshal Erwin Rommel's nearly exhausted *Afrika Korps*, he displayed a slavish adherence to careful, conservative battlefield man-

agement. The same style also characterized his later campaigns in Sicily, Italy and Normandy. Yet, in *Market Garden*, his audacity astonished friend and foe alike. According to Cornelius Ryan's *A Bridge Too Far*, Field Marshal Gerd von Rundstedt, German commander in chief, West, had characterized Montgomery as "overly cautious, habit-ridden and systematic." He was incredulous that Montgomery was responsible for the spectacular assault. Writing after the war, Bradley said, "It seemed wholly improbable that [*Market Garden*] had sprung from Montgomery's ultraconservative mind."

Montgomery, 56 years old at the time of *Market Garden*, was at the pinnacle of his career. He had chafed under the command of Eisenhower, whose grasp of the battlefield he often belittled. He resented Eisenhower's assuming direct command of Allied ground forces and continually objected to the broad-front strategy. With the war's end nearly in sight, Montgomery seems to have been consumed by the need to wage one last ground campaign, vindicate his military judgment and secure his place in history. His giant ego and natural competitiveness made the distinction of being the first to reach Berlin a near obsession.

That Montgomery was a brilliant leader and battlefield commander can hardly be disputed, and it is nearly inconceivable that he failed to recognize the risks inherent in *Market Garden*. Clearly, he understood the complexities of airborne operations, for he had written on the subject as early as 1941. Yet, it seems his swift advance through France and Belgium, combined with highly optimistic initial



Paratroopers from the 101st Airborne Division under fire from the 363d Volksgrenadier Division in the Nijmegen bridgehead, Holland, 9 October 1944.

intelligence estimates of German strength and intentions, conspired to dull his normally cautious nature and raise his tolerance for the odds confronting him. One of Montgomery's biographers, Nigel Hamilton notes in *Monty: The Making of a General, 1898-1942*, that the "only flagrant risk [Montgomery] allowed his forces to take in the course of World War II—the parachute assault on Arnhem—proved to be an expensive failure."

Ironically, some within Montgomery's command harbored serious misgivings about the likelihood of *Market Garden's* success. But Montgomery's autocratic and imperious style of leadership did little to encourage discussion or candor, and his overpowering personality apparently suppressed any real debate. In the final hours before the assault, new intelligence reports placed two *SS Panzer* divisions in the Arnhem area—yet Montgomery rashly ignored the ominous news. *Market Garden* would "go" as planned.

In fairness to Montgomery, critics must remember Eisenhower, even after developing last-minute reservations about *Market Garden*, also declined to intervene. From a viewpoint of command authority, Eisenhower's decision was probably correct and

completely consistent with his penchant for giving his commanders wide discretion. However, as Supreme Commander, he shared responsibility for the unsuccessful operation.

Another factor that may have influenced and emboldened Montgomery was that Eisenhower and General George C. Marshall, the Army's chief of staff, were eager and impatient to use Breton's newly formed 1st Airborne Army. For that force to be sitting idle in England was "a great waste of a valuable resource," said Bradley after the war. Both Eisenhower and Montgomery saw *Market Garden* as an ideal airborne mission.

Characteristically, Montgomery never acknowledged the plan for *Market Garden* had been flawed. In his memoirs, he continued to insist that had he been properly backed from the inception of the operation and given the aircraft, ground forces and administrative resources for the job, the operation would have succeeded despite his mistakes, the adverse weather or the presence of the II *SS Panzer* Corps in the Arnhem area. To the end, he remained *Market Garden's* unrepentant advocate.

Although *Market Garden* failed to fulfill Montgomery's expectations, it was, nevertheless, a watershed event in the evolution of airborne doctrine. Heavy German losses in the attack on Crete in 1941 had first cast doubt on the use of airborne forces in assaulting strongly held enemy positions. Two years later, unfavorable US and British experiences

*Lawrence Massengill is a military historian and free lance writer living in Dexter, Oregon. He has had a lengthy career as an aerospace industry executive, seminar leader and management consultant. He served in the US Air Force.*

in Sicily raised still more questions about the limitations of lightly armed parachute and glider-borne forces. But it was the disaster that befell the courageous troopers of *Market Garden* that was to spell

an end to such tactics. Never again in the course of World War II, or later conflicts, would large airborne formations be deployed as they had been that fateful September. *MR*

## September 1944 Combat Studies Institute, USACGSC

**Friday 1**—In Italy, the British Eighth Army succeeds in penetrating the Gothic Line. The US Fifth Army crosses the Arno River.

In southern France, the First French Army captures Nice, while in northern France, Canadian troops liberate Dieppe.

**Saturday 2**—General Dwight D. Eisenhower directs US First and Third armies to halt because of the inability to bring supplies forward from the Normandy beaches.

The Finnish government agrees to Russian peace terms, leaves the Axis and orders all German troops out of Finland.

**Sunday 3**—The British Guards Armored Division of the British 21st Army Group liberates Brussels, Belgium.

**Monday 4**—The British 11th Armored Division liberates Antwerp, Belgium.

Adolf Hitler reinstates Field Marshal Gerd von Rundstedt as overall commander in chief, West.

**Tuesday 5**—The Soviet Union declares war against Bulgaria, which surrenders 20 hours later.

**Wednesday 6**—Sixteen US Navy aircraft carriers begin a series of air strikes against the Western Carolines.

The British government relaxes blackout requirements across the United Kingdom and suspends training of the Home Guard.

**Thursday 7**—Bulgaria declares war on Germany. Hungarian and Romanian forces fight each other over possession of Transylvania.

**Friday 8**—The first German V-2 rockets hit England, landing in west London.

**Saturday 9**—With the creation of a pro-communist government in Bulgaria, the Red Army halts operations in that country.

**Sunday 10**—The II French Corps, advancing up the Rhone River, seizes Dijon and links up with elements of the 12th Army Group.

The *Waffen SS* attack on the Polish Resistance continues in Warsaw, Poland. The mayor of Warsaw makes an appeal for Allied help.

**Monday 11**—Elements of the US First Army cross into Germany, near Stalzenburg. They also liberate Luxembourg.

**Tuesday 12**—The German garrison of Le Havre surrenders to the British I Corps.

Romania agrees to Allied peace terms, which include going to war against the Axis.

**Wednesday 13**—Soviet aircraft begin dropping supplies to the Polish Resistance forces in Warsaw.

**Thursday 14**—Units of the First White Russian *Front* enter Praga, a suburb of Warsaw.

**Friday 15**—Against stiff Japanese resistance, the US 1st Marine Division invades Peleliu Island.

**Saturday 16**—On the Eastern Front, Red Army units enter Sofia, Bulgaria's capital.

On Peleliu, the US Marines consolidate their beachhead and capture the airfield.

**Sunday 17**—Field Marshal Sir Bernard L. Montgomery's 21st Army Group launches Operation *Market Garden*, an ambitious plan to drop 20,000 paratroopers to seize bridges leading up to the Rhine River.

In China, the US Fourteenth Air Force is forced to evacuate its Kweilin air base.

**Tuesday 19**—In the Netherlands, British XXX Corps advances to link up with the US 82d Airborne Division at Grave. The Germans begin to isolate and attack the British 1st Parachute Division at Arnhem.

The German garrison of Brest, after a prolonged siege, surrenders to the US VIII Corps.

**Wednesday 20**—In the Carolines on Peleliu, strong Japanese resistance continues. The US 8th Division secures Angaur Island there.

**Thursday 21**—In the Philippines, 12 US aircraft carriers launch air strikes against Luzon.

German attacks force the encircled 1st British Airborne Division out of Arnhem. The Allies airdrop a Polish parachute brigade near Arnhem.

**Friday 22**—The German garrison of Boulogne surrenders to the 3d Canadian Division.

Forces of the Leningrad *Front* capture Tallinn, the capital of Estonia.

Eisenhower orders General George S. Patton Jr. to halt his US Third Army offensive from the Moselle because of supply shortages.

**Sunday 24**—Red Army units advance from Poland, some 20 miles into Czechoslovakia.

**Monday 25**—The Nazi government establishes the *Volkssturm*, a militia run by the Nazi party to

draft men up to age 65 for combat.

**Wednesday 27**—In northern France, Canadian troops enter Calais. The US Third Army launches an offensive against Metz.

**Friday 29**—On Palau in the Carolines, US forces continue to reduce isolated pockets of Japanese troops.

**Saturday 30**—The Third Ukrainian *Front* advances from Romania into Yugoslavia toward Belgrade.

The German garrison of Calais surrenders to the 3d Canadian Division.

## Letters continued from page 3

The MCS V.10.1.X-Windows software received final evaluation this past summer during the ATCCS III Test at Fort Hood, Texas. CECOM SIED anticipates worldwide fielding beginning in FY 1995.

CECOM is also working on an NDI hardware

upgrade that will support both MCS V.10.1.X-Windows and the V.12 software system into the next century. This hardware upgrade is expected to be relatively low in cost, smaller and lighter than the current system and provide a significant increase in processing speed and software storage capacity. The hardware upgrade is essential since the V.10.1.X-Windows software is expected to consume maximum current NDI capacity. The V.12 prototype software already surpasses it.

My message is that there is still hope for the current MCS system. V.10.1.X-Windows is just the first step in providing commanders, staff officers and their soldiers a more user-friendly system for conducting maneuver C<sup>2</sup> and establishing a software environment for future enhancements.

MAJ Clyde J. Sincere, USA, Army  
Experimentation Site, Fort Lewis, Washington

# MR Insights

## The FAO: Soldier-Diplomat for the New World Order

Colonel John B. Haseman, US Army Copyright 1994

The new world order is highlighted by pockets of instability in many areas of the world as new regional powers seek equilibrium--or disequilibrium--in the Middle East, Southeast Asia, Europe and Africa. Never before have US interests required such accurate calculations in intelligence gathering, preparing crisis-reaction plans and planning and executing a variety of options along the spectrum of warfighting intensity.

**Emerging Combat Multiplier.** The role played by area specialists prior to and during the Gulf War has emphasized the increasing importance of foreign area officers (FAOs). FAOs were essential to the planning and execution of the smashing victory won by coalition forces in the Gulf War.

Highly trained, regionally skilled and language qualified, FAOs represent an emerging "combat multiplier" essential to the US Army as it enters a new era of geopolitical strategy and uncertainty. As all segments of the US Armed Forces decline in numbers and weaponry to their lowest levels since Vietnam, combat multipliers will assume an increasingly important role in the strategic and tactical arsenal. The Army must prepare for its role as a smaller and more reactive, yet still critical, instrument of US foreign policy.

The multiplier effect of strategically placed FAOs available at the Army and joint staff levels, at the

regional major commands and in various regions as military attachés and security assistance officers will often be the key to success in gaining timely information and analysis, performing sensitive diplomatic tasks, assisting in the policy decision-making process and conducting military deployments. As the Armed Forces' best-trained regional experts, experienced FAOs help plan and execute the Army's support to our nation's foreign policy.

**Intensive Training Challenge.** FAOs have been in the Army's force structure since the mid-1970s, when the Vietnam-era specialties of the Foreign Area Specialist Trainee (FAST) Program and the Military Assistance Training Adviser (MATA) Program were combined into the FAO Program, and specialty code 48 was assigned. Prior to the establishment of code 48, FAST members were mostly intelligence specialists, and the MATA Program provided advisers for the security assistance and advisory programs in Vietnam. The FAO Program combines the core skills of each former organization to produce a highly trained, highly motivated area specialist who is intimately knowledgeable of the language, culture, history and politico-military dynamics of a variety of geographic areas around the world.

The FAO Program requires a longer period of training than for most Army specialties. By the time a FAO becomes fully qualified, the Army will have

invested from three to four years and tens of thousands of dollars in his or her FAO training. Each FAO officer will be qualified as a specialist in a geographic region or specific country. Successful FAOs usually have an intense interest in foreign cultures and a keen understanding of politico-military strategy, geopolitics and military science.

These officers are also the product of an extensive training program in the art of strategy at both the US Army War College, Carlisle Barracks, Pennsylvania, and the US Army Command and General Staff College, Fort Leavenworth, Kansas. Additionally, they must remain fully qualified in their basic branch skills and succeed in branch-specific assignments appropriate to rank and experience to maintain promotion eligibility. It is a tough, but very rewarding job in terms of professional achievement and unique personal experience.

Usually, the first training requirement a FAO trainee achieves is a *master's degree* in regional studies, history or political science. FAO candidates must be accepted into a university graduate school on their own merit (in competition with other applicants), and they must complete the required degree program within the time limits imposed by both the educational institution and the Army.

*Language qualification* is also required in at least one regional language, for which training ranges from four to 24 months. Language training, either at the Defense Language Institute in Monterey, California, or the Foreign Service Institute in Arlington, Virginia, is often followed by additional extensive overseas language training for the most difficult languages, such as Chinese and Korean. Asian languages fall into the linguist category of "difficult," and courses range in length from 36 weeks (Indonesian or Malay) to two years (Chinese).

Another training component is *in-country training*. A minimum of one year, and often as much as three years, of familiarization training is required in the region of specialization. For example, many Southeast Asia FAO trainees attend a host country staff college. Attendance is combined with extensive in-country and regional study and travel.

Also, many FAO officers are graduates of a foreign army staff college or have equivalent military education. For instance, the Southeast Asia FAO trainee attends an army staff college in Thailand, Malaysia, Indonesia or the Philippines. The Indonesian FAO trainee attends an advanced-language program, armed forces orientation courses and the Indonesian Army Command and Staff School as part of a 14-month, in-country training program.

**Tactical Readiness.** With the end of the Cold War, the Army is preparing for missions that emphasize a need for rapid reaction to crises across the spectrum

of combat intensity but which are likely to concentrate at the lower end of the scale. Operations other than war (OOTW) is not a new concept, but its formal recognition in Army and joint doctrines places new emphasis on what is the most likely scenario for future Army deployments in this era of global geopolitical uncertainty.

While the role of the FAO in the Gulf War has been widely publicized, less is known about past significant FAO contributions to OOTW around the globe. The United States has committed military forces to a number of contingencies in recent years. The evacuation of US Embassy staffs, dependents and other noncombatant citizens from Burma, Liberia and Somalia; natural disasters in Bangladesh and the Philippines; momentous geopolitical changes in Eastern Europe, the Baltic States and Central Asia; and reaction to and monitoring of military coups in Thailand and Haiti—all have required commitment of US military forces during the past five years. The deployment of multiservice forces to Somalia for peacemaking, peacekeeping and humanitarian missions under UN auspices is a recent example of FAO contributions to OOTW.

**Strategic Readiness.** The importance of the FAO in today's complex world is illustrated in both Army and joint strategic planning in the Asia-Pacific region. The US Pacific Command (USPACOM) strategy of constructive engagement stresses bilateral relationships with US allies and friendly nations in the region.

The US Army, Pacific (USARPAC) stresses its Expanded Relations Program as the key to its role as the Army component of USPACOM in the joint strategic plan for the Pacific region. Using security assistance, officer and enlisted personnel exchanges, training and exercises with foreign armies throughout the region and its capability for rapid response to natural disasters in its huge geographic area of responsibility, USARPAC maintains its forward presence as a key part of the overall USPACOM mission. Staff officers managing the Expanded Relations Program at USARPAC headquarters are almost all Army FAOs. Also, the security assistance and attachés manning the far-flung host country end of the many bilateral soldier-to-soldier relationships are almost all Army FAOs.

Whether on an embassy country team, major command staff or in Washington, D.C., the FAO's responsibilities are unique and demanding. Decision makers turn to the FAO for information on current developments and trouble spots, insight and analysis of trends and events and detailed knowledge in planning contingency operations. Each contingency operation has an important impact on US national interests, foreign policy and the safety of Americans abroad. Each requires accurate and

timely reporting and analysis for national-level decision making. Also, each contingency has as an important ingredient—the presence of proactive Army FAOs, deeply involved in planning and supporting emergency actions and working at the heart of the policy-making and decision-making operational process.

During evacuation planning of the US Embassy in Rangoon in 1988, the defense attaché was designated by the US ambassador as the overall project officer for both planning and executing the evacuation. This challenge included providing for the safe evacuation of diplomats and dependents from more than a dozen other friendly countries in an extremely tense and dangerous environment. In Thailand, FAOs provided critical reporting during military coups d'état in 1981 and 1991. In the Philippines, FAOs were critically involved in emergency evacuation of dependents during the Mount Pinatubo eruption and in providing security assistance to the Philippine armed forces in their counterinsurgency efforts. During US relief operations after a devastating cyclone struck Bangladesh in 1991, the Army FAO defense attaché (a graduate of the Bangladesh Army Command and General Staff College) was the critical contact for the USPACOM task force, which was commanded by and largely composed of US Marine Corps personnel.

**Worldwide Ambassadors.** FAO officers can expect repetitive assignments to their region of specialization or to Army and joint staff assignments dealing directly with various regions of the world. But FAOs gain credibility with both foreign and US military forces only when they are good soldiers and good diplomats.

Fully qualified FAOs serve at US embassies in security assistance billets and the Defense Attaché System; in politico-military staff billets at the major unified commands; and on the Army and joint staffs in Washington, D.C. Virtually all Army billets in the Defense Attaché System require FAO officers. A significant portion of security assistance billets also require FAOs.

FAOs on embassy staffs throughout the world provide key understanding on the foreign politico-military, historical, social and religious aspects of international relations. FAOs in Middle East embassies and throughout the joint US military force in the

gulf played an absolutely critical role in establishing and maintaining the delicately balanced international coalition that was essential for success in the Gulf War. FAOs in embassies as far away as Indonesia and Malaysia focused host country attentions on the political equation making up the coalition and helped overcome the natural Islamic bias that pro-Iraqi propaganda instigated in those two Muslim countries.

Experience has also shown that even the FAO trainee at a foreign staff college is much more than just a "student." Many countries regard foreign participation in their staff college as a symbol of US foreign policy commitment, and the FAO student at their staff college is an instrument of US foreign policy.

Army FAOs are deeply appreciated where they are assigned. Host country military officers view them as military diplomats knowledgeable in the affairs of their countries and better able to advise and assist in the various components of the country-to-country and military-to-military relationships. Language qualified, knowledgeable and aware of the key politico-military nuances in their region of expertise, FAOs are key members of both the embassy and military staff organizations. One of the first questions a US ambassador is likely to ask his Army attaché or security assistance chief is "Are you a FAO?"

Whether the mission is peaceful assistance to friends in need, restoring or maintaining peace as part of a UN peacekeeping force or sustaining our own readiness through realistic training with other nations, tomorrow's challenges will be more variable and less predictable than ever before. FAOs, a politico-military combat multiplier, know the world's regions better than just about anybody else. These soldier-diplomats will continue to be a priceless asset to the US Army as it moves toward the 21st century. **MR**

*Colonel John B. Haseman is an Asian studies expert at Fort Leavenworth, Kansas. He has been a Southeast Asia foreign area officer since 1975, serving in Jakarta, Indonesia; Rangoon, Burma; Thailand; the Republic of Korea; and Vietnam, and is a linguist in the Burmese, Indonesian and Thai languages. He received a B.A. from the University of Missouri, an M.P.A. from the University of Kansas and an M.M.A.S. from the US Army Command and General Staff College. He is a graduate of the US Army War College.*

## Chemical and Biological Defense Workshop

The US Army Edgewood Research, Development and Engineering Center is sponsoring the "Third Workshop on Stand-off Detection for Chemical and Biological Defense" in cooperation with the US Navy, Air Force and Marine Corps. The workshop will be held at the Holiday Inn 1776, Williamsburg, Virginia, 17 to 21 October 1994. For additional information, contact Sonya Herrin, Science and Technology Corporation, (804) 865-7604.

precision, accuracy and devastating lethality. But the key to Bruchmüller's success was that, in addition to his tactical and technical knowledge and his strict attention to detail, he inspired tremendous confidence in the infantrymen he supported, says the author.

In covering World War II, Gudmundsson examines the efforts on both sides to improve the ability to mass fires. He cites a motto used in the *Grossdeutschland* Division—"many tubes, few rounds, suddenly on a single point"—as an example of a *Wehrmacht* massing technique. The 18th Artillery Division is another example of German innovation in rapidly concentrating massed artillery fires. The 18th Division was fully motorized and could move quickly to provide massed fires at critical places and times. It employed a central fire control battery that rapidly processed fire orders to multiple battalions of artillery. According to the author, the fire control battery used an "electronic computer linked to a series of teletype machines," and it was "aware" of firing unit locations. On the Allied side, Gudmundsson cites examples of US improvements in the area of massing the fires of many units. There is the work done at Fort Sill, Oklahoma, in the mid-1930s in developing the battalion fire direction center along with special techniques for a method of delivering massed fires—the "time-on-target."

In the postwar years, *On Artillery* shifts attention to other US developments and to Israeli artillery advances. Gudmundsson highlights the US Marine Corps' work in coordinating the fires of artillery, tactical air support and naval gunfire through the use of a fire support coordination center. This innovation ultimately led to our current Army and Marine Corps doctrine of integrating all fires through the use of fire support elements at command and control posts. One US artillery aspect ties directly to the notion of the "great divorce." The message is that, in the post-World War II era, the relative degree of separation between field artillery and the ground-gaining arms is largely based on perception. During World War II, the Korean War and especially the Vietnam War, US artillery was so responsive that the average infantryman or tankner began to think of fire support as a readily available commodity—a piped-in utility as Gudmundsson calls it. In peacetime training, however, when live fires are rarely used and when fire support planning and execution are largely simulated, artillery functions become misunderstood, and the appreciation of artillery decreases.

This brings us to the end of *On Artillery*. Up to this point, the author's presentation is coherent and well thought out. Unfortunately, his two-page conclusion does not compare favorably with the rest of the book. It appears superficial. Gudmundsson summarizes by telling us that the "story of field artil-

lery . . . is largely the tale of the great divorce." He depicts a combined arms battle divided into discrete struggles. He characterizes this schism with mortars, assault guns, antitank guns and grenade launchers filling the role of traditional field artillery. In the same vein, artillery has become more technical and less attuned to the needs of the ground-gaining arms as it concentrates on the battle at depth.

Without question, Gudmundsson's metaphor of the great divorce accurately describes a valid dilemma. By contrast, his proposed solution to the problem, the development of the Fiber-Optic Guided Missile (FOG-M), appears to miss the mark. With FOG-M, a gunner using a joystick will be able to guide a missile onto a distant target through the use of a wire-linked video image. For Gudmundsson, the simplicity of this weapon will eliminate the technical complexity of the gunnery problem, allowing artillerymen to concentrate on more important tactical considerations. He states that FOG-M could bring about a return to the relative simplicity of the 1870s battlefield.

The author clearly omits several important considerations. For example, while FOG-M may be an excellent weapon, it is not as uncomplicated as the author would have us believe. Its fire must still be planned, coordinated and delivered on an increasingly complex battlefield. Obviously, a gunner peering at a FOG-M video screen will not see anything resembling the target array at Sedan. It is ironic that Gudmundsson zeroes in on FOG-M—a future infantry weapon—while excluding the major US field artillery developments. He neglects to mention weapons such as the advanced field artillery system, the lightweight 155mm howitzer and the high-mobility rocket system. All of these share a common developmental goal of increased mobility, lethality and, above all, responsiveness.

Perhaps there is a better solution for the great divorce to be extracted from *On Artillery*. It can be found in the accomplishments of Bruchmüller. The term "combined arms" may not have existed in Bruchmüller's lexicon, but he surely understood its essence and practice. He demonstrated that through the proper exercise of leadership, a commander could harness the synergy of integrated fires and maneuver not only to defeat the enemy, but to protect the friendly force as well.

All in all, *On Artillery* is an outstanding book. It should be required reading at the staff college level.

*Lieutenant Colonel Clement W. Ritterhouse, US Army Reserve, is the chief, Concepts and Technology Branch, Directorate of Combat Developments, US Army Field Artillery School, Fort Sill, Oklahoma. He has a B.A., Pennsylvania State University, and is a graduate of the US Army Command and General Staff College.*



# Review Essay

## Artillery From Bruchmüller to the Great Divorce Lieutenant Colonel Clement W. Rittenhouse, US Army Reserve

**ON ARTILLERY** by Bruce I. Gudmundsson. 176 pages. Praeger Publishers, Westport, CT, 1993. \$35.00 clothbound, \$16.95 paperback.

Bruce I. Gudmundsson's *On Artillery* is more than a nuts-and-bolts, technical assessment of modern field artillery. It provides thought-provoking insights into the dynamics of combined arms. In it, Gudmundsson explains the evolution of artillery in terms of the changing nature of artillery tactics in support of the ground-gaining arms. In a sense, his theme hinges on the separation or physical withdrawal of artillery from the immediate front, an event brought about by the battlefield conditions of World War I. The author tells us this rift—what he calls the “great divorce” in the trenches—is a pivotal occurrence with far-reaching implications.

The main subject of *On Artillery* is the development of French and German field artillery from the time of the Franco-Prussian War to the end of World War II. At that point, the book shifts its emphasis to US and Israeli postwar developments. Gudmundsson displays an impressive knowledge of the history of artillery. His writing style is precise, detailed and unquestionably the result of extensive research.

*On Artillery* begins with the Battle of Sedan, a prime example of warfare in the latter part of the 19th century. Although this era was characterized by technological advances, battle retained a degree of relative simplicity. Generals on horseback could see the battlefield as they maneuvered troops and directed fire. Gunners and their weapons, deployed in the midst of the infantry, fired at targets they could also see. We learn of a German two-phase approach to operations. The first phase consisted of an intense artillery duel where all guns were physically grouped into a single “grand battery” for the purpose of attacking enemy guns and troops. The second phase began as forces closed with the enemy, at which point the “grand battery” would dissolve into smaller units of batteries and single pieces that would accompany the infantry as it advanced.

In discussing the years leading up to World War I, Gudmundsson addresses the advent of light, quick-firing field guns, of which the now famous “French 75” is a prime example. We learn of the Japanese practice of massing the fires of many guns to achieve decisive results during the Russo-Japanese War of

1904–1905, the German concept of the *Schwerpunkt* and its requirement for overpowering artillery fire and, finally, both the French and German approaches to counterfire. At that time, most European armies relied on light, rapid-firing, flat-trajectory weapons that usually engaged the enemy in direct fire.

Of course, as Gudmundsson tells us, all this would change with the onset of trench warfare. The use of flat-trajectory guns gave way to larger caliber, curved-trajectory howitzers that were more effective in dropping shells on troops in defilade. The intense fires of the trench lines meant artillery could no longer be employed at the front with the infantry. It had to be repositioned behind the lines for survivability. During this period, indirect fire gunnery procedures were refined and perfected. Counterbattery fires took on greater importance, giving rise to the adoption of special survivability measures. On the one hand, artillery became an increasingly complex arm capable of delivering tremendous volumes of fire power at critical places and times. On the other hand, the technical complexities of indirect fires meant a marked decrease in responsiveness to the needs of the troops in the trenches. This is the “great divorce” where gunners and infantrymen were physically separated and viewed combat from different vantage points. The infantry was concerned about an enemy that was imminently close, on the other side of no man’s land, while the gunners attacked targets they could no longer see but which were equally threatening from a greater distance. The advent of “hip-pocket artillery” such as trench mortars organic to the infantry was a byproduct of this development.

Gudmundsson describes the efforts on both sides to improve the effectiveness of artillery by increasing cooperation between it and the infantry. The French formula—“artillery conquers and infantry occupies”—summed up the use of barrages prior to the attack. Then, there is Georg Bruchmüller, the German artillery genius who was a virtual troubleshooter moving from sector to sector on both fronts, attacking with massed artillery fires in support of major operations. Bruchmüller’s barrages were thoroughly planned in terms of coordination and required effects, and more important, they were executed with

precision, accuracy and devastating lethality. But the key to Bruchmüller's success was that, in addition to his tactical and technical knowledge and his strict attention to detail, he inspired tremendous confidence in the infantrymen he supported, says the author.

In covering World War II, Gudmundsson examines the efforts on both sides to improve the ability to mass fires. He cites a motto used in the *Grossdeutschland* Division—"many tubes, few rounds, suddenly on a single point"—as an example of a *Wehrmacht* massing technique. The 18th Artillery Division is another example of German innovation in rapidly concentrating massed artillery fires. The 18th Division was fully motorized and could move quickly to provide massed fires at critical places and times. It employed a central fire control battery that rapidly processed fire orders to multiple battalions of artillery. According to the author, the fire control battery used an "electronic computer linked to a series of teletype machines," and it was "aware" of firing unit locations. On the Allied side, Gudmundsson cites examples of US improvements in the area of massing the fires of many units. There is the work done at Fort Sill, Oklahoma, in the mid-1930s in developing the battalion fire direction center along with special techniques for a method of delivering massed fires—the "time-on-target."

In the postwar years, *On Artillery* shifts attention to other US developments and to Israeli artillery advances. Gudmundsson highlights the US Marine Corps' work in coordinating the fires of artillery, tactical air support and naval gunfire through the use of a fire support coordination center. This innovation ultimately led to our current Army and Marine Corps doctrine of integrating all fires through the use of fire support elements at command and control posts. One US artillery aspect ties directly to the notion of the "great divorce." The message is that, in the post-World War II era, the relative degree of separation between field artillery and the ground-gaining arms is largely based on perception. During World War II, the Korean War and especially the Vietnam War, US artillery was so responsive that the average infantryman or tanker began to think of fire support as a readily available commodity—a piped-in utility as Gudmundsson calls it. In peacetime training, however, when live fires are rarely used and when fire support planning and execution are largely simulated, artillery functions become misunderstood, and the appreciation of artillery decreases.

This brings us to the end of *On Artillery*. Up to this point, the author's presentation is coherent and well thought out. Unfortunately, his two-page conclusion does not compare favorably with the rest of the book. It appears superficial. Gudmundsson summarizes by telling us that the "story of field artil-

lery . . . is largely the tale of the great divorce." He depicts a combined arms battle divided into discrete struggles. He characterizes this schism with mortars, assault guns, antitank guns and grenade launchers filling the role of traditional field artillery. In the same vein, artillery has become more technical and less attuned to the needs of the ground-gaining arms as it concentrates on the battle at depth.

Without question, Gudmundsson's metaphor of the great divorce accurately describes a valid dilemma. By contrast, his proposed solution to the problem, the development of the Fiber-Optic Guided Missile (FOG-M), appears to miss the mark. With FOG-M, a gunner using a joystick will be able to guide a missile onto a distant target through the use of a wire-linked video image. For Gudmundsson, the simplicity of this weapon will eliminate the technical complexity of the gunnery problem, allowing artillerymen to concentrate on more important tactical considerations. He states that FOG-M could bring about a return to the relative simplicity of the 1870s battlefield.

The author clearly omits several important considerations. For example, while FOG-M may be an excellent weapon, it is not as uncomplicated as the author would have us believe. Its fire must still be planned, coordinated and delivered on an increasingly complex battlefield. Obviously, a gunner peering at a FOG-M video screen will not see anything resembling the target array at Sedan. It is ironic that Gudmundsson zeroes in on FOG-M—a future infantry weapon—while excluding the major US field artillery developments. He neglects to mention weapons such as the advanced field artillery system, the lightweight 155mm howitzer and the high-mobility rocket system. All of these share a common developmental goal of increased mobility, lethality and, above all, responsiveness.

Perhaps there is a better solution for the great divorce to be extracted from *On Artillery*. It can be found in the accomplishments of Bruchmüller. The term "combined arms" may not have existed in Bruchmüller's lexicon, but he surely understood its essence and practice. He demonstrated that through the proper exercise of leadership, a commander could harness the synergy of integrated fires and maneuver not only to defeat the enemy, but to protect the friendly force as well.

All in all, *On Artillery* is an outstanding book. It should be required reading at the staff college level.

Lieutenant Colonel Clement W. Rittenhouse, US Army Reserve, is the chief, Concepts and Technology Branch, Directorate of Combat Developments, US Army Field Artillery School, Fort Sill, Oklahoma. He has a B.A., Pennsylvania State University, and is a graduate of the US Army Command and General Staff College.

## MR Book Reviews

**WAR AND RESPONSIBILITY: Constitutional Lessons of Vietnam and Its Aftermath** by John Hart Ely. 244 pages. Princeton University Press, Princeton, N.J. 1993. \$24.95 clothbound. \$12.95 paperback.

John Hart Ely is the Robert E. Paradise Professor at Stanford University. He was formerly the Tyler Professor of Constitutional Law at Harvard University, as well as dean of the Stanford Law School. He states the purpose of his book as follows:

"This book is about another legacy of the Cold War—unfortunately, it's about dishonesty, too,—the disappearance of the separation of powers, the system of checks and balances, as it applies to decisions to go to war. Contrary to the words and unmistakable purpose of the Constitution, contrary as well to reasonably consistent practice from the dawn of the republic to the mid twentieth century, such decisions have been made throughout the Cold War period by the Executive, without significant Congressional participation (or judicial willingness to insist on such participation). It is common to style this shift a usurpation, but that oversimplifies to the point of misstatement. It is true our Cold War presidents generally wanted it that way, but Congress (and the courts) ceded the ground without a fight. In fact, and this is much of the message of this book, the legislative surrender was a self-interested one; accountability is pretty frightening stuff."

Actually, as Ely so generously points out, the book is the result of collegial efforts by legal scholars, students and experts concerning one of the perplexing issues of our time. Chapter 1 is an excellent exposition of the constitutional framework of how we go to war. Up to the start of the Korean War in 1950, by and large, presidents and the US Congress generally followed the provisions of the Constitution (although presidents James Polk, Woodrow Wilson and Franklin Roosevelt certainly pushed the extremes of the envelope). Korea, however, was definitive as a new paradigm. To this day, there are people who insist that the Korean War was not a war, but a "police action."

The problems associated with the Vietnam War are thoroughly analyzed in Chapter 2. The explanations are lucid and the rationale compelling. Basically, hostilities in Vietnam had congressional authorization, and the Cambodian Incursion of April and May 1970 (which, the reader will recall, led to the

confrontation at Kent State University where students were killed) appears to have been constitutionally authorized by the Congress.

On 12 January 1971, Congress repealed the Tonkin Gulf Resolution, which authorized the executive branch to take appropriate action against the North Vietnamese. Many thought this congressional action should have ended the war, but Ely describes the situation as follows:

"By 1971 the situation was far from that: Congress had by then, by a number of appropriation measures, quite pointedly reiterated its authorization of the war. Moreover, and not surprisingly under the circumstances, it continued after its repeal of the Tonkin Gulf Resolution to appropriate funds for military activities in Southeast Asia, and to extend the draft."

Now then, what about the bombing of Cambodia in 1973? Basically, Ely maintains that the bombing was illegal from 1 April 1973 to 1 July 1973, but was legal from 1 July through 14 August. To have lived through this in Southeast Asia at that time was an interesting experience, as those of us who did will attest.

The chapter on the war in Laos is worth reading. It is instructive as to what may, and probably will, happen when authorization is provided, but the concomitant responsibility of the military is muddled by both the legislative and executive branches of the government. Undoubtedly there will be circumstances in the future that will be comparable to those which led us into Laos in the past. The lesson should be that "secret" wars might be compared to the asymptomatic patient who discovers one day that his single tumor has metastasized into a malignant cancer.

Well, just what does Ely recommend for the future? Better that you should read the book for all the details. Generally, Ely and his friends recommend that the act of going to war should rest in the hands of the Congress and not the president. Like all good lawyers, he recommends that any deviation, however small, should require immediate action by the courts. Hopefully, the very threat of such action is enough to terrify any citizen into walking a straight constitutional line. Whether the solution is to give the power to declare war to the judicial branch, however, is doubtful. Nothing could be more exciting than judges playing field marshal. Just imagine Oliver Wendell Holmes playing general. He would make

General William T. Sherman look like a pacifist.

Maybe it is not all bad to take the advice of the professional military. We might call Ely's attention to what he wrote early in his book.

"For the moment at least, it seems to be professional soldiers who provide the most reliable brake on the ill-conceived military schemes of amateurs, though thoroughly not so reliable that we should continue to tolerate the exclusion of Congress from the process." In fact, it has not been just for the moment—it has been ever thus if people would just care to study and listen. A study of this book will provide any professional soldier plenty of material to convince civilian leadership that frequently we do have recommendations that are not only wise, but constitutionally and politically correct.

LTG Richard G. Trefry, USA, Retired, Clifton, Virginia

---

**UNCERTAIN WARRIORS: Lyndon Johnson and His Vietnam Advisers** by David M. Barrett. 279 pages. University Press of Kansas, Lawrence, KS 1993. \$35.00.

In *Uncertain Warriors*, David M. Barrett, an assistant professor of political science at Villanova University, scrutinizes three years of the Vietnam War: 1965, with its firm US decision to send troops; 1967, the year of troop escalation, and 1968, with the Tet offensive and its aftermath.

In each of these years, he shows President Lyndon B. Johnson consulting with a diverse group of advisers before making decisions. Eventually known as the "wise men," these individuals included such people as Chairman of the Joint Chiefs of Staff and Ambassador to Vietnam General Maxwell Taylor and Undersecretary of State George Ball. While Ball's 1965 paraphrase of Sun Tzu—"great powers cannot beat guerrillas"—now appears prophetic, Johnson bought the domino theory urged by Robert S. McNamara, Dean Rusk and Dean Acheson.

In the beginning, Johnson held regular Tuesday meetings encouraging open debate on the Vietnam issues. However following the 1968 Tet offensive, these meetings were not the same. As tensions grew, Johnson began to "uninvite" those who dissented with his views. For two months, he tried to build a consensus among his advisers, but his advisory system had become competitive and chaotic. Johnson did not want to hear "bad news."

By the time George Carver of the Central Intelligence Agency briefed Johnson on 27 March 1968 that pacification in Vietnam was not working the president was not listening, constantly taking phone calls and repeatedly asking Carver if he was done, finally on 31 March, Johnson announced that he

was not going to run for another term. This was primarily due to the US involvement in Vietnam.

One also wonders what effect the polls had on Johnson's decision making during this time. In 1965, Johnson enjoyed an overwhelming 2-to-1 approval of his continued efforts in Vietnam. As more Americans were killed or wounded, sentiment changed. By July 1967, the disapproval rate had climbed to 52 percent, a trend that followed into the 1968 Tet offensive.

How did the president use his advisers, and how did he arrive at his decisions in each of the three years? Barrett's conclusions come in his last two chapters. While it was awkward having to return to some of the previous text to see if I agreed with his conclusions, I found that most of the time I did. His analysis and conclusions are well done.

This is a good book. It is concise and well documented. Almost 100 of its 279 pages contain footnotes. I recommend it to both history buffs and those whose lives Vietnam touched, who still wonder how and why decisions were made on US involvement. I especially recommend it to key decision makers who may have to commit US military forces. History shows that the military does extremely well in those missions where clear military goals and objectives are established and proper training has been accomplished. Anything else invites tragedy.

COL William C. Malkemes, USA, US Army Space and Strategic Defense Command, Huntsville, Alabama

---

**THE DOMESTIC BASES OF GRAND STRATEGY.** Edited by Richard Rosencrance and Arthur A. Stein. 230 pages. Cornell University Press, Ithaca, NY, 1993. \$21.95.

*The Domestic Bases of Grand Strategy* is a superb collection of essays that together present an exceptional picture of the importance of the domestic factor in the grand strategic decision-making process. Making skillful use of both theory and historical precedent, the collective authors of this volume show that any nation's development of a grand strategy, without full consideration of its own and others' domestic influences, is a blunder of potentially enormous proportions.

The two domestic influences most commonly discussed are economics and popular opinion. Economics, the authors all appear to agree, can be a two-edged sword that provides incentives to aggressors while simultaneously inhibiting peaceful states from acting on behalf of international victims. The greatest economic paradox occurs, however, when statesmen recognize an imperative need to involve their states in international affairs, if not conflict, but

"economics" prevents them from garnering the needed popular support to act. In these instances, states tend to either undercommit or overextend themselves. The result is that the international situation either worsens while critical states sit passively on the sideline or those states intervene with such insufficient forces or assets that they simultaneously exacerbate the situation and embroil themselves.

Arthur A. Stein says that since "overextension may reflect less a true ability to meet commitments than an unwillingness to bear their costs," the role of public support far exceeds that of pure economics in the formulation and evaluation of domestic influences on grand strategy. The authors clearly indicate that national leaders must do more than simply wait for domestic influences and opinions—the foundations of public support—to form of their own accord. As England and Prime Minister Neville Chamberlain discovered, this can lead to woeful unpreparedness when the time for action becomes the prevalent mood.

Instead, national leaders must work to formulate national opinion and lead their states in the direction policy dictates. They must evaluate how other states' leaders are formulating their domestic opinions as quite possibly the most important criterion for assessing the aggressive or peaceful nature of any given state. John Mueller provides great depth to this discussion in his contribution, "The Impact of Ideas on Grand Strategy."

Today, nationalistic statesmen are leading their economically deprived populace along aggressively one-sided paths while the United States struggles to determine the correct balance between its own means and ends. This book provides invaluable insight and guidance to those who formulate US grand strategy or who evaluate the grand strategy of other states. More important to us in the military, those same lessons say a great deal about how we determine the balance between waiting patiently for orders to execute versus endeavoring to influence our nation's grand strategy formulation through the appropriate advising of our commander in chief. *Grand Strategy* is a superb text for educating us in that regard.

LTC Ronald Bonesteel, USA, 1st Infantry Division (Mech), Fort Riley, Kansas

---

**HARVEST OF FEAR: A History of Australia's Vietnam War** by John Murphy. 335 pages. Westview Press, Boulder, CO. 1994. \$19.95

In *Harvest of Fear*, John Murphy produces an excellent and readable account of Australia's involvement in its longest and most controversial war—the Vietnam War. He begins by tracing the

colonial history of Baria Province—renamed Phuoc Tuy in 1956—under French rule. Murphy begins by identifying the local population's "sense of place," showing how the rural social order was attachment to the land and to one's native village and, by veneration, to ancestors—all of which tied family and lineage to place. This social order had great impact later on the Australian army's attempts to relocate entire villages.

The Communist Party in Baria Province began to have an influence in 1931. Identified as coming from within the population and supported by the local workers, it survived the French military repression. Through its formation of broad alliances and a mass organization, it became the driving force for the Nationalist cause.

The fall of Dien Bien Phu in 1954 was viewed with alarm in Australia. Murphy portrays this lack of understanding in Australian political circles of Vietnam's emergence from colonial rule. In a very readable account, he explains why the Ngo Dinh Diem regime failed to become a legitimate political force and to win the support of the people (crucial to success in a counter-revolutionary war). Diem played on Australia's lack of understanding of Vietnamese history. It became clear later that Diem's party had little support in the countryside. The party had built up a strong network, and Baria Party cadre were already forming the D445 battalion, which would clash repeatedly with the Australians in the 1960s.

There is a comprehensive account of conscription and the peace movement in Australia and the role played by Jim Cairns. Conscription was and will remain an emotive issue, given the Australian anathema to militarism and the great conscription campaigns in World War I. Unfortunately, the army was to bear the brunt of the protestors' anger. The legacy of conscription and the Vietnam War haunts the Australian army today. As Murphy says, perhaps "the final, and saddest, irony of the Vietnam intervention [was] that its veterans were denied even the simple dignity and solace of the returning soldier." Returning veterans were condemned outright and despised by some sections of the population.

Murphy deals brilliantly with why the government of Vietnam (GVN) and the Australian forces were doomed to strategic failure: the poor reliability of the GVN forces, the strength of the party at the local level, the support of the National Liberation Front and, at home, the impact of the moratorium movement.

Readers who wish to understand the complex situation into which the Australian army was placed need to look no further than this excellent book. By pulling together an account of the social and

political life in colonial and post-colonial Vietnam, the Australian Cold-War policies and the impact of the antiwar movement, Murphy produces a masterful account of Australia's Vietnam War. I highly recommend this book.

LTC Michael Goodyer, *Australian Army, Combined Arms Center—Training, Fort Leavenworth, Kansas*

**THE THIRD WAVE: Democratization in the Late Twentieth Century** by Samuel P. Huntington. 366 pages. University of Oklahoma Press, Norman, OK. 1991. First paperback printing, 1993. \$16.95 paperback.

The "third wave" refers to the transition to democracy of approximately 30 countries between 1974 and 1990. (The first wave was 1828 to 1926, the second, 1943 to 1962.) The importance of *The Third Wave* is reflected in the following quotation: "If one is concerned with liberty as an ultimate social value, one should also be concerned with the

fate of democracy . . . Other nations may fundamentally change their political systems and continue their existence as nations. The United States does not have that option."

Not all readers will agree with the particulars of Samuel P. Huntington's historical notes or with some of his assumptions. Still, this book is a perfect vehicle for debate. Why do democratic transitions occur? Huntington points out that no single factor is sufficient and no single factor is necessary. The explanation depends on the nature of the individual case, and Huntington provides a thorough presentation of explanatory models. One disappointment is that the book does not address technological change or democracy apart from the nation-state.

In the self-described role of a modern day Machiavelli, Huntington intersperses the text with "guidelines for democratizers." In one fascinating list, he suggests what is to be done for democrats to stay in power after the downfall of an authoritarian regime. Some of his pointers are to be careful with

## PASS IN REVIEW

**BUTLER'S BAITLIN' BLUE BASTARDS** by Thor Ronningen. 222 pages. Brunswick Publishing Corp., Lawrenceville, VA. 1993. \$19.95.

Thor Ronningen's book is a celebration of his World War II comrades-in-arms in the 3d Battalion, 395th Infantry, 99th Infantry Division. Recollections of 37 of the unit's veterans form the core of the book, personalizing the story of the battalion's trek from training at Camp Van Dorn, Mississippi, through the Battle of the Bulge, to V-E Day in Bavaria. World War II buffs will enjoy the eyewitness accounts. --MAJ Dana M. Mangham, USA, *US Military Academy, West Point, New York*

**NEW NUCLEAR NATIONS: Consequences for U.S. Policy.** Edited by Robert D. Blackwell and Albert Carnesale. 272 pages. Council on Foreign Relations Press, New York. 1993. \$17.95.

Proliferation of nuclear weapons is the most difficult threat confronting the United States since the demise of the Soviet Union. This comprehensive book lays out the US policy difficulties in a post-Cold War environment where proliferation appears to be growing rather than receding. It explores all options for US policy makers, including diplomatic, offensive and defensive military options. With contributions from two of President Bill Clinton's national security appointees, policy options recommended could become reality. --CPT Gilles Van Nederveen, USAF, *Anderson Air Force Base, Guam*

**THE D-DAY ATLAS: The Definitive Account of the Allied Invasion of Normandy** by John Man. 143 pages. Facts on File, Inc., New York. 1994. \$24.95.

This is a nice atlas to carry when visiting the Normandy battlefield. Covering the time period between 6 June and 20 August with some clarity, it provides the nonhistorian a brief overview of events leading up to the invasion, a quick review of the battlefield and some excellent personal vignettes of heroic action at the soldier level. While the maps are very informative and colorful, I recommend a good geographic study of Normandy before reading the book to enhance one's understanding of the D-Day events. --LTC C. Eric Fardelmann, USA, *Department of Joint and Combined Operations, USACGSC*

treaty making—the absence of a foreign threat may enhance military inclination to think about politics; ruthlessly punish leaders of attempted coups; and immediately purge military reformers, as well as authoritarian loyalists, as they cannot be trusted.

The book is optimistic. "From the early nineteenth century down to 1990 . . . democracies did not . . . fight other democracies . . . [T]he spread of democracy in the world means the expansion of the zone of peace in the world." Huntington also asserts, "In practice, with one exception, no Islamic country has sustained a fully democratic political system for any length of time." The reader can leave with the feeling that we will continue to be in conflict with countries whose cultural systems are not compatible with democracy.

Huntington has become somewhat of an icon due to the success of his *Political Order in Changing Societies* and more so among military readers because of the impact of his *Soldier and the State*. As such, it was preordained that *The Third Wave*

would quickly become a landmark. This book, an explanation of what Huntington describes as perhaps the most important global political development of the late 20th century, will be staple reading in many disciplines.

LTC Jeff Demarest, USA, *Foreign Military Studies Office, Fort Leavenworth, Kansas*

**WAR AND TELEVISION** by Bruce Cumings. 311 pages. Verso, New York. 1992. \$29.95.

While a majority of media analysts contend that the Vietnam War was our first television war, Bruce Cumings argues, instead, that it was the Gulf War. This war showed us the "full totalizing potential of war television: the medium as the only message." His central theme is that the horrors of war, from the gulf, Vietnam and Korea, have been kept from our television screens.

"The war we saw in the gulf was not blood and guts on the living room rug . . . [but] a radically

**IRAQ: From Sumer to Saddam** by Geoff Simons. 406 pages. St. Martin's Press, Inc., New York. 1994. \$35.00.

The first two chapters of this book contain a virulent, unbalanced and highly anti-American discussion of the events leading up to the 1991 Gulf War, the war itself and its aftermath. The middle six chapters, however, are interesting and useful. This vital world arena is examined from the beginning of civilization to the present, showing the Western influence on Iraq's people and institutions for the last 100 years and the rise and brutal dictatorship of Saddam Hussein.—COL Earl E. Perry, USA, *Retired, Jacksonville, Florida*

**WAR IN THE MEDITERRANEAN, 1940-1943**, by Bernard Ireland. 224 pages. Arms and Armour Press, London. (Distributed by Sterling Publishing Co., Inc., New York.) 1994. \$24.95.

This narrative account primarily covers the naval war in the Mediterranean from 1940 to the fall of Tunisia in May 1943. Bernard Ireland concentrates on the siege of Malta and on Axis and Allied attempts to choke off each other's logistic pipelines to North Africa. The 65 high-quality, glossy photographs add a nice touch to the text. The book contains no footnotes or endnotes. It is an easy-to-read book for the casual reader with an interest in naval affairs.—MAJ Peter Mansoor, USA, *US Military Academy, West Point, New York*

**CIVIL WAR PRISONS & ESCAPES: A Day-by-Day Chronicle** by Robert E. Denney. 399 pages. Sterling Publishing Co., Inc., New York. 1993. \$24.95.

This excellent chronicle provides insights into the experiences of the Civil War prisoners of war (POWs) of both sides, covering almost every day from 1 May 1861 to 10 November 1865. Most Civil War students are familiar with the South's infamous Andersonville and Libby prisons, but a Texas POW writes, "If there ever was a hell on earth, Elmira prison [New York] was that hell . . . often 40 degrees below zero." I highly recommend this book for one's Civil War library or to anyone who has lived in Leavenworth, Kansas—"Prison City, USA." John A. Reichley, *Directorate of Academic Operations, USACGSC*

distanced, technically controlled [and] eminently 'cool' postmodern optic." Almost all the news was good news. He is also genuinely miffed that no serious opposition sprang up against the US involvement in the Gulf War.

He submits the working press was "handled"—processed, given the military's guidelines for media and then subjugated to press pools if they wanted to cover front-line ground units, ships or Air Force elements. He states that everything the journalist did was subject to a security review. He compares the daily reporting from the Joint Information Bureau at the Dhahran International Hotel to "covering a ghetto riot in Detroit from Chicago's O'Hare Hyatt Regency."

His greatest grievance, however, seems to be that television takes an event and abstracts it from its origins, so it can function as the "original sin." Television "demonized the enemy and elided the allies." He dislikes the fact that more Arabs were not featured on American television during the Gulf War and is perturbed that while General Norman Schwarzkopf lamented US and allied casualties, he barely mentioned the "evil enemy" casualties.

Cummings' strongest point is that the Falklands, Grenada, Panama and even the Gulf War will not be remembered long. This is because the real wars were unseen, shielded by the military from the eyes of their countrymen to make them more palatable and supportable. He implies that the postwar parades and hoopla were all hyped to make the citizenry forget the reality of war—the killing, the maiming and the suffering.

Cummings does not hide that he was against both the air and ground wars in the Persian Gulf. He was also against the Vietnam War. Throughout the book, he is extremely sympathetic to the enemies of the United States. Even though this book has a radical, left-wing slant, it is nonetheless worthwhile reading for military public affairs officers and commanders. Maybe the military did too good a job controlling the media in the gulf. And maybe we do our nation a disservice when we allow war to be shown in a cool, bloodless and antiseptic fashion. One thing is sure, the debate over media access to war coverage is far from over.

LTC Ned Baxter Ennis, USA, Public Affairs Office,  
US Atlantic Command, Norfolk, Virginia

---

**CHINESE ARMS TRANSFERS: Purposes, Patterns, and Prospects in the New World Order** by R. Bates Gill. 248 pages. Praeger Publishers, Westport, CT. 1992. \$45.00.

R. Bates Gill's book on the Chinese arms transfers could not be more timely. China surged into the ranks of the top arms suppliers in the mid-1980s,

largely by satisfying the Iran-Iraq war market. Its current military modernization and weapons export drive are of considerable interest in government and academic circles. Gill places China's arms sales squarely in the context of its foreign and national security policies. Such a perspective, notably absent in previous studies, is overdue and welcome.

Recently of the Johns Hopkins University's Paul H. Nitze School of Advanced International Studies in Washington, D.C., Gill has held two year-long teaching appointments in China and has a number of publications to his credit. This volume examines the motivations for Chinese arms transfers in the 1980s and their impact on Beijing's regional and global security.

China's weapons exports, according to Gill, serve to promote a mix of broad national interests—strategic, political influence and economic gain. He develops this thesis in a three-part framework. First, he discusses Chinese arms transfers in the global context. He next provides a region-by-region analysis of China's arms transfers to the Middle East, South Asia and Southeast Asia since 1980 (particularly the top six recipients of Egypt, Iran, Iraq, Pakistan, Saudi Arabia and Thailand, which accounted for about 90 percent of the value of China's arms transfers during that period). His concluding section is on the strategic and political purposes, patterns and prospects for Chinese weapons exports in the 1990s.

Gill examines China's arms exports since 1949. Notably, China's pattern of arms transfers closely follows Beijing's foreign relations, especially relationships with the superpowers. In the 1980s, arms exports supported China's quest for independence from the Soviet Union and the United States, influence with key neighbors and Third World states, economic growth and military modernization.

*Chinese Arms Transfers* concludes by presenting an interesting evaluation of the successes and failures in Chinese arms transfer policy and the factors likely to affect it in the future. Gill also develops a "Chinese arms transfer model" based on Beijing's security relationship with clients and on the regional concentration, quantity, quality and types of weapons exported. The model reveals a pronounced focus on Asia, especially contiguous or near neighbors, and external threats to China's periphery.

Given the variety of important interests served by arms transfers, Gill argues that China will remain in the world arms market as an important exporter, using weapons sales to promote regional influence on its strategic periphery. However, Beijing will be reluctant to join or strictly observe arms control regimes and will likely expand its supplier role if



regional conflicts erupt or spread.

This is a comprehensive, systematic, thorough and thoughtful book. It has no rival and is, therefore, *the* indispensable source on the subject.

Joseph P. Smaldone, *US Arms Control and Disarmament Agency, Washington, D.C.*

---

**PEACE PROCESS: American Diplomacy and the Arab-Israeli Conflict Since 1967** by William B. Quandt. 612 pages. The Brookings Institution, Washington, DC, and University of California Press, Berkeley, CA. 1993. \$38.95 clothbound. \$15.95 paperback.

One of the longest running conflicts in recent history is that between Israel and the Arab worlds. It is a story of constant conflict and a series of wars that often seem to threaten world peace. It is also a story of extensive diplomacy aimed at defusing the conflict and securing peace.

*Military Review* readers probably focus their study of the Middle East on the conflicts there. Some time, however, should be spent on the study of diplomacy in the Middle East. The issues leading to conflict there are complex. Anyone assigned to service in the Middle East should be aware of and seek to understand these issues, which will define the nature of our future military assistance, peace-keeping and nation assistance efforts there. For future military involvement, William B. Quandt's *Peace Process* provides an aura of realism about what we may be able to accomplish.

Quandt provides a marvelous account of US diplomacy in the Middle East from the Six-Day War to the present. A member of the National Security Council under the Nixon and Carter administrations, a participant in the Middle East peacemaking process, author of several works on the Middle East and a senior fellow at the Brookings Institute, the author is eminently qualified to undertake such a work.

His readable discussion of Middle Eastern diplomacy is backed by personal experience, and his meticulous research is reflected in the copious notes of primary and secondary sources. Quandt suggests that the pattern set in the recent past can be used to set the course for a successful future. He believes the future can move toward a more secure peace, pointing to past significant US diplomacy successes as an important ingredient in that movement.

For Quandt, the necessary ingredients for future success include realism as we view this region; involvement of the president and our top leaders; development of domestic support; a feeling for substance by our leaders and an understanding of the

processes involved; an investment in quiet diplomacy rather than a focus on immediate results; a skillful exercise of pressure; and a keen feel for timing. He shows how these have been key to US success in the Middle East over the last quarter of a century.

Anyone with an interest in the Middle East and a desire to understand the peace process there will find Quandt's book a valuable source. The appendixes include many key diplomatic documents that bear on the issues, and the notes and bibliography will point the serious student to a wealth of additional information. If there is only time to read one book on policy, as opposed to policy by other means, this is the book.

Daniel E. Spector, *Command Historian, US Army Chemical School, Fort McClellan, Alabama*

---

**GLOBAL DOUBLE ZERO: The INF Treaty From Its Origins to Implementation** by George L. Rueckert. 230 pages. Greenwood Press, Westport, CT. 1993. \$49.95.

**WORLD INVENTORY OF PLUTONIUM AND HIGHLY ENRICHED URANIUM 1992** by David Albright, Frans Borkout and William Walker. 246 pages. Oxford University Press, New York. 1993. \$39.95.

On 8 December 1987, President Ronald Reagan and Secretary General Mikhail Gorbachev sat in the East Room of the White House and signed a historic document—*The treaty between the United States of America and Union of the Soviet Socialist Republics on the Elimination of their Intermediate Range and Shorter Range Missiles* (or the Intermediate Nuclear Forces [INF] Treaty). For the first time, two nations agreed to destroy two entire classes of nuclear weapons. The INF Treaty was a landmark in its intensive and comprehensive verification provisions, which have now become standard in arms control agreements.

In *Global Double Zero*, George L. Rueckert successfully guides the reader from the Soviet INF buildup of the 1950s, through the INF Treaty negotiations of the 1980s and into the implementing organizations that continue to operate today. Although INF negotiations began in 1981, the agreement turning point came at the Reykjavik Summit in 1986. For the first time, the Soviets agreed to a comprehensive verification regime that called for an exchange of data, on-site inspection of missile eliminations and on-site monitoring of INF facilities.

Eventually, to simplify the verification process, discussions progressed to a point where the Soviets were supporting a global zero outcome on shorter-range missiles and the United States was supporting a global zero outcome on the intermediate-range

missiles. The resulting agreement allowed for the global double zero outcome—total elimination of all US and Soviet land-based missiles with ranges between 500 and 5,500 kilometers.

*Global Double Zero* contains exhaustive details of the elimination process and the verification regime that developed. The On-Site Inspection Agency, created to carry out the unique inspection and escort requirements, is thoroughly analyzed. (Rueckert was the agency's first deputy director.) This book somewhat slowly pushes through the mechanics of the most stringent verification provisions ever negotiated, which were eventually used to overwatch the destruction of 2,602 missiles on both sides in less than three years. The precedents set by this treaty have impacted on subsequent arms control agreements, such as the Conventional Forces in Europe, Strategic Arms Reduction and two chemical weapons agreements in that substantial on-site inspection provisions are included to complement national technical means of verification.

While the INF Treaty eliminated an entire class of nuclear missiles, warheads were not specifically required to be destroyed. However, with the breakup of the Soviet Union and the strategic weapon reductions that have been negotiated, warheads are expected to be dismantled soon. The disposition of the large quantities of plutonium and highly enriched uranium arising from the destruction process is of great concern. Many countries are openly seeking to proliferate nuclear weapons. This is one of the reasons that the Stockholm International Peace Research Institute published the *World Inventory of Plutonium and Highly Enriched Uranium 1992*.

*World Inventory* presents an unclassified account of the whereabouts of these fissile materials from both military and civilian sources. Generally, the book stays away from policy discussions. The authors stress that "there is no necessary correlation between quantities of material and their political and strategic impact" and that the political significance of the inventories is beyond the scope of the book.

*World Inventory* is especially useful for study and retrieval of data. It examines, in detail, the quantities from both military and civil applications found in the recognized nuclear weapon sites (the United States, the former Soviet Union, Great Britain, France and China). The inventories of the so-called threshold states are tackled in three groups: first, the authors address Israel, India and Pakistan as de facto nuclear weapon states; then, Iraq, North Korea, Iran and Algeria are discussed as "countries of concern;" and last, Argentina, Brazil, South Africa and Taiwan are described as "countries backing away from nuclear weapons."

The authors leave one with two policy issues to

consider. One issue that surfaced regularly was a need for an international registry of plutonium and highly enriched uranium. The other is a need for a management plan for plutonium and highly enriched uranium surpluses. Large quantities of both will be released from weapons dismantlement and spent fuel reactors over the next two decades. A number of issues are discussed under the surplus problem. They include such concerns as physical security to prevent highly enriched uranium from being stolen or diverted, the already concluded agreement whereby the United States will purchase a majority of Russia's stocks and a plea that a substantial effort be taken to find acceptable solutions for the surplus other than storage.

*World Inventory* is a highly academic work that is well organized and rich in useful charts, graphs and tables. It is also an excellent primer on the characteristics of plutonium and highly enriched uranium and includes detailed options of the various enrichment processes. A first-class glossary and easy-to-use index support the book's utility as a reference work. *Global Double Zero*, though significantly less technical, also contains a great amount of information. While professionals would certainly find value in either book, they are also top-notch sources for anyone striving to better understand current arms control issues.

LTC Darryl W. Kilgore, USA, US Army War College,  
Carlisle Barracks, Pennsylvania

---

**STONEWALL: A Biography of General Thomas J. Jackson** by Byron Farwell. 512 pages. W. W. Norton & Co., New York. 1992. \$29.95 clothbound. \$14.95 paperback.

Most biographies of Thomas J. "Stonewall" Jackson present a flattering account of a faultless man, who by the midpoint of the four-year Civil War enjoyed more fame than any other Northern or Southern general. With *Stonewall*, we now have a balanced account of a contradictory, strong-willed and militarily brilliant man.

From the First Battle of Manassas to the Battle of Chancellorsville, Jackson excelled on the field of battle as General Robert E. Lee's most capable lieutenant. Byron Farwell now balances Jackson's story by revealing he was also an often vindictive, devoutly religious, strangely secretive and mistrusting, hypochondriacal leader whose life and military career before the Civil War were both unimpressive and unspectacular.

A US Military Academy graduate, Jackson was cited for gallantry and meritorious conduct at Contreras and at Chapultepec during the Mexican War.

He was then posted to Fort Hamilton, New York, where he developed interests in religion and his health, interests that would obsess him for the rest of his life. It was during the 1850s that a less flattering image of Jackson emerges. His pursuit of a vindictive, unfair campaign against his commanding officer while stationed at Fort Meade, Florida, almost destroyed his own career and presents him at his most petty. It is a prelude to the types of interpersonal problems he would later have with others, such as Generals A. P. Hill and Richard B. Garnett.

Resigning his commission in 1851 to accept a teaching position at the Virginia Military Institute (VMI), Jackson spent the next 10 years as a mediocre professor of philosophy, a source of ridicule among his students. When the Civil War erupted in 1861, Jackson was commissioned as a colonel and assigned to Harper's Ferry. Farwell details Jackson's many battlefield successes (and failures), his rapid rise in rank and command, culminating with his bold and daring offensive at Chancellorsville, where he was shot by Confederate troops who mistook him for a Union officer.

*Stonewall* is well researched, with interesting, informative footnotes. It provides enlightening descriptions of cadet life at West Point and of 19th-century customs and traditions. The maps are well placed and of sufficient detail to be of assistance to the reader. The author devotes a chapter to each of the major battlefield actions in which Jackson played a significant part, from Harper's Ferry in April 1861 until Chancellorsville in May 1863.

Farwell rightly concludes that Jackson had perhaps reached the height of his capabilities in command of a corps at the time of his death. While brave and willing to take risk, he was unable to avoid personality clashes with other generals, a drawback that would undoubtedly have doomed him to failure at higher levels of command.

MAJ James M. Milano, USA,  
1st Infantry Division, Fort Riley, Kansas

---

**A RISING THUNDER: From Lincoln's Election to the Battle of Bull Run: An Eyewitness History** by Richard Wheeler. 413 pages. HarperCollins Publishers, New York. 1994. \$30.00.

This is Richard Wheeler's 11th book in his eyewitness series. *A Rising Thunder* focuses on the period from November 1860 to July 1861, the prelude and beginning of the American Civil War. Wheeler's firsthand witness accounts capture the emotions of the moment, illuminating and personalizing the major events of this time.

The author tells of the ill feelings and sectional

contention which had progressed to such an extent that, once unleashed, they became uncontrollable. After Abraham Lincoln's election, secession, long a topic of discussion, was then seen as the only recourse open to the South. Lincoln's lack of a firm response allowed the South free rein in its headlong rush to become a separate country. Concurrently, efforts were being made to raise a Southern army to secure the newly gained freedom. Only after the fall of Fort Sumter, South Carolina, did Lincoln call for Northern volunteers. The last remaining states to secede now did so.

As both sides prepared for what they hoped would be a short struggle, their respective positions became more acutely polarized and exclusive. The initial moves and skirmishes are described with a sense of excitement and novelty by the participants. The initial thrill and confidence of moving against the enemy displayed by both sides only heightened their shock as they discovered the true face of war. The graphic descriptions of the wounded and the dead and the fear and the confusion of battle soon tell a story of its own.

*A Rising Thunder* is appropriately titled. The storm clouds of war were developing. A hint of the lightning, wind and rain could be seen, a warning to seek shelter. Many saw, but few heeded. Like them, I knew what was coming, yet I could hardly stop reading. I had to go on with their story. This volume is worthy of your time if your interest lies in this turbulent period.

MAJ William T. Bohne, USA, Retired,  
Leavenworth, Kansas

---

**THE PATTONS: A Personal History of an American Family** by Robert H. Patton. 352 pages. Crown Publishers, Inc., New York. 1993. \$25.00 hardcover.

The grandson of the most famous American warrior-general of World War II (General George S. Patton Jr.) writes an intimate history of the Patton family, providing an excellent insight into the personal thoughts, character and personalities of this exceptional family. Relying almost exclusively on private letters, diaries and the personal recollections of surviving family members, Robert H. Patton produces a lively, highly readable book that is as entertaining as it is illuminating. His prose is surprisingly skillful as he deftly weaves the countless family anecdotes and stories into an outstanding narrative that flows smoothly from chapter to chapter.

Although 200 pages are devoted to the life of General Patton, other family members receive their fair share. And quite an interesting lot they are.

Consider Patton ancestor Hugh Mercer, a Scottish immigrant who made a habit of rebelling against English kings (in Scotland in 1746, then in America in 1776). Mercer died a general and hero of the American Revolution, but there was some irony to his passing. As a young surgeon ministering to the rebel forces of "Bonnie Prince Charlie," he survived English bayonets and brutality in the bloody retaliation after the disastrous rebel defeat at Culloden (1746) only to succumb to a later generation of English Redcoats wielding bayonets at the Battle of Princeton 30 years later.

General Patton's grandfather, Confederate Colonel George Smith Patton, also died a hero of the unsuccessful revolution waged by the Confederacy against the Federal government. Fatally wounded in the 1864 Battle of Winchester, Colonel Patton's death and the image of gallant youth dying while valiantly defending the "Lost Cause" was frequently invoked by his widow Sue and, through her son, to young grandson George. This helped fuel the internal fires of romanticism and glorification of warriors and combat that characterized General Patton's attitudes toward warfare for the rest of his life.

Robert Patton shows that General Patton's seemingly antiquated and somewhat idiosyncratic views about the nature and conduct of war and his peculiar beliefs, such as reincarnation, did not simply emerge unplanted from his active imagination. Instead,

Robert Patton establishes a family pattern of such ideas and attitudes that characterizes the Pattons down through the generations.

And not to be overlooked are the Patton women, who proved just as important as the better-known men of the family in shaping *The Pattons* development and history. These remarkable women include Catherine DuBois, a French Huegenot; Sue Glassell Patton, Southern belle and Confederate war widow; Ruth Wilson Patton (General Patton's mother), whose much-needed stability and down-to-earth common sense counterbalanced her husband's (and spinster sister Nellie's) spoiling and hero-worship of young Georgie; and Beatrice Ayer Patton, a Boston belle who became the general's partner for life, suffering through the worst of his self-destructive behavior, surviving his untimely death by a few short years.

All in all, Robert Patton produces an excellent and well-written description of an interesting and remarkable group of men and women comprising this famous American family. Combined with Martin Blumenson's *The Patton Papers* and *Patton: The Man Behind the Legend* and Roger Nye's *The Patton Mind*, this Patton family history is an outstanding additional resource for those studying the colorful World War II general and his intriguing family.

COL. Jerry D. Morelock, USA,  
Combat Studies Institute, USACGSC

## DTIC Users Training Conference

The Defense Technical Information Center (DTIC) is holding its Annual Users Training Conference on 31 October to 3 November 1994 in Arlington, Virginia. The 1994 theme is "Today's Information Meeting Tomorrow's Challenges." For further information, contact Ms. Patti Miller at (703) 274-3848 or DSN 284-3848.

## Combat Training Centers Bulletin

The Center for Army Lessons Learned (CALL), US Army Combined Arms Center, Fort Leavenworth, Kansas, will periodically publish a new bulletin, beginning with "Combat Training Center (CTCs) Bulletin No. 94-1, Mar 94," to provide commanders with current and useful warfighting information. The bulletin will present tactics, techniques and procedures from the CTCs. Due to limited resources, the bulletin is distributed only to appropriate major organizations, agencies and individuals, not through publication channels. Contact your appropriate higher element if your unit or office is not receiving distribution. Queries may also be directed to Commander, Combined Arms Center, ATTN: ATZL-CTL, Fort Leavenworth, KS 66027-7000.

## CALL News From the Front

The *News From The Front (NFTF) Bulletin* is published by the Center for Army Lessons Learned (CALL), Fort Leavenworth, Kansas. This eight-page, monthly bulletin contains timely information and lessons on exercises and real-world events and subjects. CALL welcomes your input and will assist in the editing, with credit given to authors. Questions should be directed to Sergeant Terry Durben (for initial distribution) or to Lon R. Seglie/Jim Walley (to contribute to the bulletin) at DSN 552-2255/3935 or (913) 684-2255. Facsimile numbers are DSN 552-3959 or (913) 684-3959.

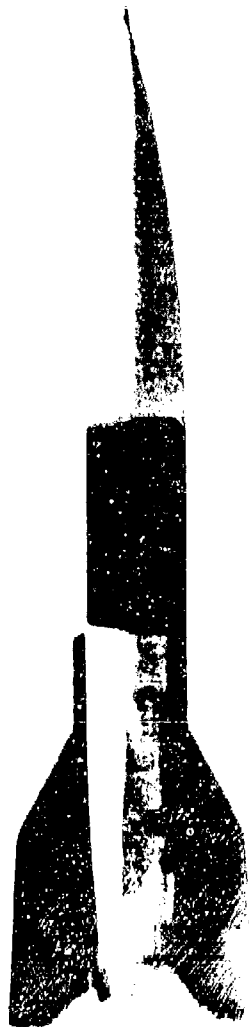

# V-2

## Nazi Terror Weapon

The V-2 rocket, *Vergeltungswaffe* or reprisal weapon, was developed from rocket experiments dating back to the early 1930s. On 6 September 1944, two missiles were fired at Paris. Two days later, England was struck by two V-2s. During the next six months, England would be struck by 1,188 more missiles.

The V-2 was used almost exclusively against civilian targets, and the "V" designation was, itself, part of Adolph Hitler's psychological warfare campaign aimed at terrorizing the British people. Nazi English-language propaganda broadcasts gleefully warned Britons of the immense destruction that would be wreaked on their cities by a never-ending rain of "vengeance" rockets.

The V-1 "buzz bomb" that preceded the V-2 could be shot down by antiaircraft guns or fighters. Once launched, the V-2 was invulnerable to interception. Upon launch, the rocket-propelled missile rose vertically to an altitude of about 6 miles, then arced upward to about 50 miles. Preset controls cut off the fuel, liquid oxygen and alcohol, to provide the desired range. Then the missile tipped over and hurtled earthward to its target, reaching a speed of nearly 4,000 mph or roughly 1 mile per second. The entire 200-mile flight from launch point to target took only 3 to 4 minutes.

During the course of the war, US and Soviet forces captured V-2s and their scientists. Sixty-nine captured V-2s were test-fired in the United States. On 6 September 1947, one was fired from the deck of the aircraft carrier USS *Midway*. The V-2s and their inventors served as the foundation for ballistic missile and space programs in both the United States and Soviet Union.



(Above left) Father of the V-2 rocket program, Dr. Wernher von Braun, with brother Magnus, after their surrender to Seventh Army troops, 3 May 1945. They fled eastern Germany with rockets, papers and other scientists before their experimental station at Peenemunde was overrun by Soviet forces. (Left) One of von Braun's V-2s at the Army Ordnance Proving Ground, White Sands, New Mexico, 10 May 1946.