

UNCLASSIFIED

AD NUMBER

AD366716

CLASSIFICATION CHANGES

TO: unclassified

FROM: confidential

LIMITATION CHANGES

TO:

Approved for public release, distribution unlimited

FROM:

Notice: Release only to U. S. Government Agencies is authorized. Other certified requesters shall obtain release approval from Director, Defense Nuclear Agency, Attn: STTI. Washington, DC 20305.

AUTHORITY

DSWA ltr., 9 Apr 97; DSWA ltr., 9 Apr 97

THIS PAGE IS UNCLASSIFIED

7 BUREAU OF SHIPS GROUP
TECHNICAL INSPECTION REPORT

CONFIDENTIAL

Classification (Cancelled) (Changed to
By Authority of Joint Chiefs of Staff (Action 75 Apr 49)
By *James R. ...* *24 Apr 51*
J. W. AF SWP

306716

6 OPERATION CROSSROADS.
U.S.S. INDEPENDENCE (CVL22)

TEST ABLE,

8

VOLUME 1 OF 4 [U].

11 1947,

12 280 P.

U. S. GOVERNMENT ... OF THIS REPORT DIRECTLY FROM DDC. OTHER ... THROUGH

14 XRD-30

~~OPERATION CROSSROADS~~

Defense Atomic Support
Washington, D. C. 203

DIRECTOR OF SHIP MATERIAL

JOINT TASK FORCE ONE

DDC
NOV 2 1985
RESOLVED

CONFIDENTIAL

TECHNICAL LIBRARY
of the
ARMED FORCES
SPECIAL WEAPONS PROJECT

Downgraded at 12 year intervals;
Not automatically declassified.

REG. NO. _____

10 386

BUREAU OF SHIPS GROUP
TECHNICAL INSPECTION REPORT

CONFIDENTIAL

Classification (~~Secret~~) (Changed to _____)
By Authority of Joint Chiefs of Staff (Action 15 Apr 49)
By *J. A. ...* Date *21 Apr 51*
124 H. A. J. ...

U. S. GOVERNMENT AGENCIES MAY OBTAIN COPIES OF THIS REPORT DIRECTLY FROM DDC. OTHER AGENCIES AND USERS SHALL REQUEST THROUGH

Director
Defense Atomic Support Agency
Washington, D. C. 20301

APPROVED:

F. X. Forest,
Captain, U.S.N.

CONFIDENTIAL

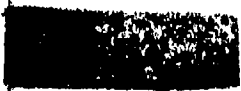

USS INDEPENDENCE (CVL22)

Page 1 of 280 Pages

GROUP 3
Downgraded at 12 year intervals
Not automatically declassified.

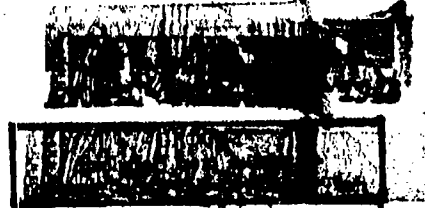

VOLUME 1

Index of Plates - - - - -	3
Ship Characteristics Sheet - - - - -	7
Midship Section - - - - -	8
Overall Summary - - - - -	9
Hull Technical Inspection Report (Section I) - - - - -	31
Machinery Technical Inspection Report (Section II) - - -	131
Electrical Technical Inspection Report (Section III) - - -	159
Ship Measurement Data and Damage Diagrams (Appendix)	198
Commanding Officer's Report (Appendix) - - - - -	252

VOLUME 2

Photographic Section - - - - -	1-250
--------------------------------	-------

VOLUME 3

Photographic Section - - - - -	251-508
--------------------------------	---------

VOLUME 4

Photographic Section - - - - -	509-766
--------------------------------	---------

SECRET

USS INDEPENDENCE (CVL22)

CONFIDENTIAL

1	Damage - Port Profile - - - - -	202
2	Damage - Starboard Profile - - - - -	203
3	Flight and Hangar Deck Deflections at Centerline -	204
4	Flight Deck Damage - - - - -	205
4A	Contour Outlines of Hangar Deck Depression - - -	206
5	Flight and Hangar Deck Deflection - Transverse Section, Frame 56 - - - - -	207
6	Flight and Hangar Deck Deflection - Transverse Section, Frame 59 - - - - -	208
7	Flight and Hangar Deck Deflection - Transverse Section, Frame 62 - - - - -	209
8	Flight and Hangar Deck Deflection - Transverse Section, Frame 65 - - - - -	210
9	Flight and Hangar Deck Deflection - Transverse Section, Frame 68 - - - - -	211
10	Flight and Hangar Deck Deflection - Transverse Section, Frame 71 - - - - -	212
11	Flight and Hangar Deck Deflection - Transverse Section, Frame 74 - - - - -	213
12	Flight and Hangar Deck Deflection - Transverse Section, Frame 77 - - - - -	214
13	Flight and Hangar Deck Deflection - Transverse Section, Frame 80 - - - - -	215

SECRET

USS INDEPENDENCE (CVL22)

26	Main and 2nd Deck Deflection - Transverse Section, Frame 53 - - - - -	228
27	Main and 2nd Deck Deflection - Transverse Section, Frame 108 - - - - -	229
28	Main and 2nd Deck Deflection - Transverse Section, Frame 122 - - - - -	230
29	Flight and Hangar Deck Deflection - Transverse Bulkhead, Frame 45 - - - - -	231
30	Main and 2nd Deck Deflection - Transverse Bulkhead, Frame 49 - - - - -	232
31	Main and 2nd Deck Deflection - Transverse Bulkhead, Frame 57 - - - - -	233
32	Main and 2nd Deck Deflection - Transverse Bulkhead, Frame 113 - - - - -	234
33	Main and 2nd Deck Deflection - Transverse Bulkhead, Frame 119 - - - - -	235
34	Flight, Hangar, Main and 2nd Deck Deflection - Transverse Bulkhead, Frame 126 - - - - -	236
35	Main and 2nd Deck Deflection - Transverse Bulkhead, Frame 132 - - - - -	237
36	Main and 2nd Deck Deflection - Transverse Bulkhead, Frame 138 - - - - -	238
37	Main and 2nd Deck Deflection - Transverse Bulkhead, Frame 144 - - - - -	239

SECRET

USS INDEPENDENCE (CVL22)

1	Damage - Port Profile - - - - -	202
2	Damage - Starboard Profile - - - - -	203
3	Flight and Hangar Deck Deflections at Centerline -	204
4	Flight Deck Damage - - - - -	205
4A	Contour Outlines of Hangar Deck Depression - - -	206
5	Flight and Hangar Deck Deflection - Transverse Section, Frame 56 - - - - -	207
6	Flight and Hangar Deck Deflection - Transverse Section, Frame 59 - - - - -	208
7	Flight and Hangar Deck Deflection - Transverse Section, Frame 62 - - - - -	209
8	Flight and Hangar Deck Deflection - Transverse Section, Frame 65 - - - - -	210
9	Flight and Hangar Deck Deflection - Transverse Section, Frame 68 - - - - -	211
10	Flight and Hangar Deck Deflection - Transverse Section, Frame 71 - - - - -	212
11	Flight and Hangar Deck Deflection - Transverse Section, Frame 74 - - - - -	213
12	Flight and Hangar Deck Deflection - Transverse Section, Frame 77 - - - - -	214
13	Flight and Hangar Deck Deflection - Transverse Section, Frame 80 - - - - -	215

SECRET

USS INDEPENDENCE (CVL22)

PLATE NO.	TITLE	PAGE NO.
14	Flight and Hangar Deck Deflection - Transverse Section, Frame 83 - - - - -	216
15	Flight and Hangar Deck Deflection - Transverse Section, Frame 86 - - - - -	217
16	Flight and Hangar Deck Deflection - Transverse Section, Frame 89 - - - - -	218
17	Flight and Hangar Deck Deflection - Transverse Section, Frame 92 - - - - -	219
18	Flight and Hangar Deck Deflection - Transverse Section, Frame 95 - - - - -	220
19	Flight and Hangar Deck Deflection - Transverse Section, Frame 98 - - - - -	221
20	Flight and Hangar Deck Deflection - Transverse Section, Frame 101 - - - - -	222
21	Flight and Hangar Deck Deflection - Transverse Section, Frame 104 - - - - -	223
22	Flight and Hangar Deck Deflection - Transverse Section, Frame 107 - - - - -	224
23	Flight and Hangar Deck Deflection - Transverse Section, Frame 110 - - - - -	225
24	Flight and Hangar Deck Deflection - Transverse Section, Frame 113 - - - - -	226
25	Flight and Hangar Deck Deflection - Transverse Section, Frame 115 - - - - -	227

SECRET

USS INDEPENDENCE (CVL22)

26	Main and 2nd Deck Deflection - Transverse Section, Frame 53 - - - - -	228
27	Main and 2nd Deck Deflection - Transverse Section, Frame 108 - - - - -	229
28	Main and 2nd Deck Deflection - Transverse Section, Frame 122 - - - - -	230
29	Flight and Hangar Deck Deflection - Transverse Bulkhead, Frame 45 - - - - -	231
30	Main and 2nd Deck Deflection - Transverse Bulkhead, Frame 49 - - - - -	232
31	Main and 2nd Deck Deflection - Transverse Bulkhead, Frame 57 - - - - -	233
32	Main and 2nd Deck Deflection - Transverse Bulkhead, Frame 113 - - - - -	234
33	Main and 2nd Deck Deflection - Transverse Bulkhead, Frame 119 - - - - -	235
34	Flight, Hangar, Main and 2nd Deck Deflection - Transverse Bulkhead, Frame 126 - - - - -	236
35	Main and 2nd Deck Deflection - Transverse Bulkhead, Frame 132 - - - - -	237
36	Main and 2nd Deck Deflection - Transverse Bulkhead, Frame 138 - - - - -	238
37	Main and 2nd Deck Deflection - Transverse Bulkhead, Frame 144 - - - - -	239

SECRET

USS INDEPENDENCE (CVL22)

PLATE NO.	TITLE	PAGE NO.
38	Main and 2nd Deck Deflection - Transverse Bulkhead, Frame 147 - - - - -	240
39	Blister Damage - Frames 71-89, Port Side - - - - -	241
40	Blister Damage - Frames 92-113, Port Side - - - - -	242
41	Deck Survey - - - - -	243
42	Deck Survey - - - - -	244
43	Deck Deflection Gages - - - - -	245
44	Deck Deflection Gages - - - - -	246
45	Plot of Main Deck Movement - Scratch Gage Data - Frame 63, Port - - - - -	247
46	Plot of Main Deck Movement - Scratch Gage Data - Frame 120, Port - - - - -	248
47	Plot of Main Deck Movement - Scratch Gage Data - Frame 120, Starboard - - - - -	249
48	Plot of Main Deck Movement - Scratch Gage Data - Frame 121, Centerline, - - - - -	250
49	Plot of Main Deck Movement - Scratch Gage Data - Frame 124, Centerline - - - - -	251

SECRET

USS INDEPENDENCE (CVL22)

Building Yard: New York Shipbuilding Corporation.

Commissioned: 14 January 1943,

HULL

Length Overall: 67 feet 6 inches.

Length on Waterline: 600 feet 0 inches.

Beam (extreme, at or below waterline): 71 feet 6 inches.

Beam (extreme, above main deck): 109 feet 2 inches.

Depth (to flight deck, Fr. 12): 67 feet 5 5/8 inches.

Depth (to flight deck, Fr. 150): 69 feet 3 1/8 inches.

Drafts at time of test: Fwd. 23 feet 0 inches.

Aft. 23 feet 9 inches.

Standard displacement: 11,000 tons.

Displacement at time of test: 13,840 tons.

MAIN PROPULSION PLANT

Main Engines: Four sets of General Electric turbines, one set per shaft.

Reduction Gears: Four sets of General Electric double reduction.

Main Condensers: Four installed in ship.

Boilers: Four Babcock and Wilcox installed in ship. 565 psi gauge, 350° F.

Propellers: Four installed in ship.

Main Shafts: Four installed in ship.

Ships Service Generators: Four installed in ship, 600 KW. each.

SECRET

USS INDEPENDENCE (CVL 22)

Page 7 of 280 Pages

OVERALL SUMMARY

I. Target Condition After Test:

(a) Drafts after test; list; general areas of flooding, sources.

The drafts of 23 feet zero inches forward, and 23 feet six inches aft are unchanged as a result of the test. There was no list before the test and it is now about 5 degrees to starboard. There are several reasons for the list, (1) removal of planes, test gear, and structure from the port side by the blast; (2) shifting of port side weights to starboard, such as catapult machinery, furniture, planes in hangar, hangar side plating, etc.; (3) flooding of starboard shaft alley; (4) movement of hangar bents and flight deck and stern structure about 1 foot toward the starboard side. The after diesel generator compartment was flooded to a height of 6 inches above the bottom of the emergency distribution switchboard. The source of flooding was due to a slow progressive leak from starboard shaft alley.

(b) Structural damage.

HULL

Superstructure: The superstructure on this ship is here considered to be the island structure, the stacks and the radio masts. All pipe frame structure and the platforms supported thereby have been blown down and off the ship by the pressure wave. The stacks have been collapsed and twisted but have remained generally in place. Radio masts have universally been twisted, bent or ripped from their locations. The island structure itself shows some minor dishing of the exposed bulkheads but is intact and usable. Doors on exposed bulkheads are severely dished and are inoperable, and the door at the hangar deck level has been torn from its hinges.

SECRET

USS INDEPENDENCE (CVL22)

the flight deck and bulkhead 45, the damage to the deck is insignificant except for the depressing of the forward edge of the elevator opening. The deck is undistorted and entirely usable. Along the port and starboard sides of the elevator opening there is no perceptible damage. Aft of the forward elevator opening the deck shows the first sign of injury, which manifests itself by a slight warping toward the port side. The starboard side remains very nearly in original alignment while the port deck edge rises rapidly, until at the expansion joint at frame 63 1/2 it is several feet above its normal position. The expansion joint has not opened perceptibly from its position before the test. The surface of the deck is in good condition materially except for two small burned areas at about frame 59 where a test airplane was located.

Beginning at the expansion joint, frame 63 1/2, the flight deck is very sharply hipped along the centerline with the wood decking broken, and several feet of the thin steel deck plating below is split. Between the expansion joints at frames 63 1/2 and 84 1/2 the deck, on the starboard side, begins to rise at the deck edge and progresses in a straight line to the hip at the centerline. On the port side between these frames there is little change from the normal position of the deck between the edge and approximately eleven feet inboard of it. From here the deck peaks sharply in a straight line to the hip at the center. In addition to the transverse deformation, the longitudinal run of the deck rises from 63 1/2 in a fair curve to about 7 feet above normal at frame 84 1/2. The sharp peaking disappears at about frame 80 where it fades into a smooth arch which continues past the expansion joint at frame 84 1/2. Except for the splintering of the wood at breaks along the centerline the surface of the deck is in materially good condition.

Between the expansion joints at frames 84 1/2 and 111 1/2, the flight deck drops in a relatively smooth curve from about 7 feet above normal to a generally normal position at 111 1/2. The ridge in this area is more pronounced because the deck maintains its normal position for about nine feet inboard of the deck edge both port and starboard, thus making a much sharper angle of rise. The wood decking here is also splintered and broken and the thin steel plating

SECRET

USS INDEPENDENCE (CVL22)

Page 10 of 280 Pages

...ately frame 63 there is a tear in the steel plate extending across most of the deck.

The after most section of the flight deck; frame 111 1/2 to the stern, is badly damaged. Between 111 1/2 and the forward edge of the after elevator opening the deck is about normal. There is a slight depressing of the deck all around the opening, and the starboard side of the deck is in fair material condition except for a slight rise towards the stern. Aft of the elevator opening and to port of the starboard side of the opening, the deck is not only not usable but is also relatively dangerous for walking. The area is badly burned and heavily distorted to port of the centerline aft of frame 132. The after edge of the deck rises at an angle of approximately 45 degrees on the port side to a point about 20 feet outboard of the centerline. At this point there is a void in the deck, which extends forward to about frame 136. This corner of the deck which has been blown away by the blast, overhurd the boundaries of the ship.

The deck is not usable as a carrier deck, and aft of frame 63 1/2 is not usable for any purposes.

Gallery Level Walkways: On the starboard side there is little discernible damage, but on the port side the walkways and overhanging tub tubs are either missing or so sharply forced upwards that the positions are useless.

Gallery and Forecastle Decks Forward of Bulkhead 45: Structural damage on these decks is limited to minor distortion of joiner bulkheads and relatively few cases of foundation displacements.

Main Deck: There is little damage to the main deck forward of bulkhead 45. From this bulkhead aft, the deck has been forced down in way of both elevators by the pressure wave which entered the hangar space, and in way of the hangar deck by the load transmitted through the transverse the longitudinal floors between the hangar and main decks. The area affected extends aft to bulkhead 126 and about 20 feet each side of the centerline. A maximum depression of 14'' in the forward elevator well occurs at

SECRET

USS INDEPENDENCE (CVL22)

Page 11 of 280 Pages

frame 122 and approximately nine feet to port. The maximum depression in way of the hangar deck is about fifteen inches, and the average depression throughout this area is about 5". Aft of bulkhead 126 the main deck is badly damaged, especially on the port side. Areas exist wherein the depression of this deck is as much as two feet, and aft of 136, port side, the deck is ripped along the shell and has been folded under itself. On the starboard side of this deck, between frames 126 and 132, fire and low order explosions torpedo air flasks occurred, which caused general havoc throughout the stern of the ship aft of bulkhead 144. This internal source of damage coupled with the direct effect of the atomic bomb burst have made the bulkheads, decks, doors, equipment, furniture, ventilation, and electrical facilities useless.

Second Deck: There is practically no damage to the second deck area from the stem to bulkhead 49. Aft of bulkhead 49 the second deck bulkheads generally buckled from the loading exerted by the main deck, but there is no discernible buckling of bulkheads below the second deck or depression of the second deck forward of bulkhead 101. The deck is depressed slightly between frames 101 and 119 aft of which very severe dishing and distortion of the deck begins, for the most part of the port side where the extreme damage to the port shell has caused long accordion pleats in the deck. Water-tightness throughout this deck aft of bulkhead 49 has been destroyed due to damage to door frames, doors, vent ducts, and cable runs.

Third Deck: There is no damage forward of bulkhead 57 which shows slight buckling. Between 57 and 91, the bulkheads show signs of elastic deflection of the second deck but have retained their tightness. The deck has not been depressed. There is some slight tripping of the port shell frames between frames 91 and 101. Aft of frame 101 the tripping and buckling of the frames becomes very pronounced. Aft of 113 the buckling is very severe and is accompanied by a definite displacement of all port side structure to starboard.

Below Third Deck: There is some slight damage to joiner bulkheads and some loss of water-tightness.

Shell - Starboard Side: The sheer strake, frames 12 to 15, shows local damage caused by the service ships when along side the INDEPENDENCE in the target area. The sheer strake and the strake next below, show a slight herringbone stress pattern at

SECRET

USS INDEPENDENCE (CVL22)

Page 12 of 280 Pages

frame 36 and 120 where a deep, wide wrinkle becomes apparent at the main deck and travels diagonally aft to frame 125 at the waterline where it merges with a series of short diagonal panel depressions, running in the same direction, which continue to the stern. The side panelling aft of bulkhead 126 and above the main deck is blown out as a result of damage in the torpedo workshop.

Shell - Port Side: There is only the faintest suggestion of panel dishing between the stem and frame 40. In the neighborhood of frame 40 there is some scorching of paint and the beginnings of discernible panel dishing which increases in severity to frame 50, where individual panel failures become apparent. At frame 70, traces of the blister longitudinals appear and continue to frame 106 with the depressions between them reaching maximums of about 18 inches at approximately frame 95. Longitudinal dishing of the blister plating is evident to frame 112. Between frames 112 and 126 the deformation of the shell is severe but varied. Aft of bulkhead 126 the wilted appearance of the port side, both above and below the main deck, bears striking witness to the tremendous force of the attacking instrument. The original character of the side plating and companion structure can be determined between frames 126 and 134 above the main deck although it is badly mauled. Between the main and third decks the shell is relatively smooth from frame 126 to 134 but shell plating and framing have been forced to starboard slightly leaving the third deck clearly defined. Below the third deck from 126 to 134 there is a deep depression giving the appearance of collision damage which is, however, due to lack of adequate framing in this area. Aft of frame 134, above the main deck, the side plating and structure is generally collapsed to frame 144. Below the main deck the sheer strake is torn as is the connection between the main deck and the sheer strake. The shell plating has been pushed to starboard and down, almost to the third deck, with deep valleys existing between the framing. The transom between the port side and centerline has collapsed and the main deck droops over the wreckage aft of 134.

Hangar Space: All but three of the light cover plates between the heavy port side columns which support the flight deck, have been blown out; some across to the starboard side of the hangar.

SECRET

USS INDEPENDENCE (CVL22)

and some overboard. The columns, with the exception of these just forward and just aft of the expansion joints, have been generally inclined slightly to starboard at the top, bent slightly forward and twisted in a counter-clockwise direction. The "wobble bent" columns, those just forward and aft of the expansion joints, have been ripped from the deck at their riveted connections to the hangar deck and definitely deformed. The light cover plates on the starboard sides are less affected by the blast, about half remaining in place. The main columns on the starboard side with one or two exceptions, show no effect of the blast. Most of the "wobble bent" columns offer only a little evidence of the tendency to lift which characterized the action of those on the port side. Both elevators have been carried over the side, bulkhead 45 is deeply dished in horizontal valleys between the forward decks, bulkhead 126 is bulged into the hangar space, and the hangar deck is deeply dished, between the longitudinal floors from frame 56 to 115. The maximum depth of this dishing occurs along the centerline at frame 89 and amounts to 15".

MACHINERY

The stacks were badly crushed and distorted at their bases and lower parts where they extend beyond the side of the ship at the hangar deck level. The upper portion of stacks #1, 3, and 4 carried away. Severe distortion of the hull near the stern is believed to have caused misalignment of the main shafting. Both airplane elevator platforms were blown overboard, pulling apart the wire rope cables. The guide rails on the port side of the after elevator were bent. The airplane crane was badly damaged structurally and is leaning outboard at an angle of about 15°. A great deal of damage was done to piping, especially in the hangar and on the flight deck, by failure or deflection of supporting structures. The port boat winch was blown overboard.

ELECTRICAL

Extensive damage to electrical equipment and wiring was a result of the damage to the superstructure and after portion of the hull by the air blast from the bomb. Deformation of bulkheads, panels, decks, and flight deck supports caused rupture of electrical boxes, panels, and appliance frames. Missiles, produced

SECRET

USS INDEPENDENCE (CVL22)

electrical equipment in their paths.

(c) Other damage.

HULL

All steam machinery below the third deck is operable if steam can be supplied. All uptakes are collapsed above the hangar deck and temporary uptakes and temporary exhaust ducts must be provided before the boilers can be lighted off. The diesel plant, consisting of two 150 KW generators, is operable. The ship control station on the bridge is operable, as in the ship control station at the forward end of the port gallery walkway. Electric lighting circuits below the main deck aft of bulkhead 45, and all circuits forward of bulkhead 45 will require only minor repairs - a few hours work by ship's force - before operation is possible. Telephones and loudspeakers are in approximately the same condition although there are some scattered phones in heavily damaged areas, which are not operable. The steering gear is operable and can be controlled from both main and secondary stations. Gyros and repeaters, in general are operable. The anchor windlass is operable. Fire control equipment is generally not operable. Below decks electronic equipment is practically all operable, while radar and other topside electronic equipment is disabled. Not all guns normally aboard the ship were in place for the test. The remaining guns on the port side are not operable; but, those on the starboard side, except the one furthest aft, and those in the forecastle are operable. Arresting gear sheaves and barrier stanchions on the flight deck appear to be intact and are generally operable, but the hydraulic gear, which is supported on the underside of the flight deck between elevators, dropped to the hangar deck because of failure of the supporting bolts when the flight deck buckled. Such hydraulic gear located aft of bulkhead 126 remained in place, but was seriously damaged from fire and distortion of the supporting structure. The elevators were blown off the ship but the elevator machinery appears to be intact except for entangled wire and a few dislocated sheaves. Upper sheaves around the elevator openings in the flight deck are warped and out of alignment. The airplane crane is not operable, being off its roller path and is cocked to starboard about 15 degrees and 10 degrees forward. The bushings, bearings, and holding down clips are marred, gouged, and somewhat mangled,

SECRET

USS INDEPENDENCE (CVL22)

and reseat the crane for use. Except for electrical connections the hoisting machinery is intact and usable. The training "A" end is intact but the "B" is shifted slightly, and is inoperable. The starboard catapult accumulator bottle has shifted about 1" to starboard and opened some of the oil line flanges. This catapult can be returned to service very quickly. The port catapult electric motor and pump have been displaced about 6" to port, oil lines are broken and gauge and control panels displaced to starboard. The catapult is inoperable and is not susceptible to quick repair. All four radio masts were in the up position for this test and were blown to starboard, generally folding over the flight deck edge. Their operating machinery, was deranged due to general buckling of all structure along the gallery walkway.

MACHINERY

No damage to the main propulsion plant or its auxiliaries was found by visual inspections and operational tests, the main engines being turned at propeller speeds of 20 RPM. However, this is not a conclusive test of the main shafting, which is believed to be out of alignment. All boilers were made inoperable by damage to stacks and uptakes, which completely sealed the gas passages. There was severe damage to piping in the hangar and on the flight deck aft of frame 50, and slight damage to piping (especially refrigeration piping) elsewhere. Wire rope cable, which broke when the elevator platforms carried away, is badly entangled in the elevator machinery. The airplane crane, in addition to being damaged structurally, sustained damage to the machinery. The rotating machinery of the crane is probably beyond repair. Ventilating fans in the hangar were demolished. The starboard boat winch, after casualty power generator diesel engine, and equipment in the carpenters', shipfitters', and torpedo workshops were burned out by the fires and explosions in the after areas of the ship and are beyond repair.

ELECTRICAL

The main electric plant, distribution switchboards and main engine and boiler auxiliaries were undamaged and operable, but due to structural damage to stacks, the boilers could not be steamed until temporary repairs were accomplished. The forward and after emergency diesel generators and associated distribution switchboards were undamaged. The after unit was not operable before the test.

SECRET

USS INDEPENDENCE (CVL22)

could be put into service.

Vital ship control telephone communications remained intact and operable. All navigation lights were completely destroyed. It would have been necessary to shift steering control to central station until emergency repairs could be completed on the bridge steering selsyn control cable.

The fire control signalling and communication systems were inoperable due to damaged wiring equipment at operating stations resulting from structural failures.

Three of the four heavy machinery guns were inoperable electrically due to rupture of power supply cables when mount foundations were deflected upward by bomb blast pressure.

II. Forces Evidenced and Effects Noted:

(a) Heat

HULL

The entire flight deck is very noticeable darkened, apparently from the heat of the blast; curved surfaces indicate a source approximately broad on the port beam and shadows support the conclusion that the relative bearing of the burst was about 225 degrees. All surfaces facing the burst are darkened and there is some scorching of paint on the inboard (port) side of the island structure. Some piping in this area shows slight blistering. There is no damage to interior paints. Paint on planes in the hangar show but slight scorching and in many cases none at all. Some manila line was scorched to approximately 1/32" depth. Cloth seam tape and the olive drap paint on an army portable radar unit are completely gone on the side exposed to the blast.

MACHINERY

Screwed union joints at gage line valves of gasoline filling stations #1, 3, and 6 pulled apart. Apparently the nuts

SECRET

USS INDEPENDENCE (CVL22)

These stations are at the outer edge of the flight deck. Other evidences of extreme heat topside are blistered paint and charred wood, canvas, leather, etc.

ELECTRICAL

Radiant heat had no appreciable effect except the blistering of exposed paint and destruction of plastic lens on indicating instruments.

(b) Fires and explosions.

HULL

There were severe fires and low order detonations but no violent explosions.

The port side aft was blown inward by the A-bomb burst, exposing about six compartments containing some bedding, and a small amount of lumber in the shipfitter and aviation metalsmith's workshops. There was, undoubtedly, some acid and paint in these shops, in the battery repair shop and in the torpedo workshop. Some of the materials in the shops, which were open to each other and to the weather - from the effect of the blast - caught fire, either from the heat of the burst or from a source which may never be determined. This fire spread through practically all compartments aft of bulkhead 126 and above the main deck, and into compartment C-204-L on the 2nd deck between bulkheads 126 and 132. About 1436 on "A" day, the fire reached the twelve torpedo warheads in compartment C-101-E on the starboard side of the main deck between frames 126 and 132. There were air flasks in the compartment and at least one Mk 24 mine. It is, of course, impossible to establish an exact order of events within the compartment, but it seems probable that the heat of the fire approaching the compartment raised the temperature sufficiently to cause exudation of the warhead filler. This filler would burn fiercely thus causing a further increase in temperature within the compartment which probably caused the torpedo air flasks to explode. Torpedo airflasks were ruptured and the propellers and tail pieces of the Mk 24 mine was found as a fragment in the compartment. The smoke and flash patterns on "A" day showed a series of bursts and flashes compatible with repetitive burning of exudate and failure of airflasks.

SECRET

USS INDEPENDENCE (CVL22)

Page 18 of 280 Pages

fire as the smoke was most intense and voluminous. This fire was extinguished on the morning of "A" plus 1 day. This flurry blew out part of bulkhead 126, ripped the starboard shell practically the full length of the compartment, blew up the overhead and ripped the main deck - thus, spreading the fire into compartment C-204-L where bedding and shoring timbers burned. The heat from this general conflagration aft of bulkhead 126 caused the smoldering and then burning of the wood covering of the flight deck. The heat was sufficiently intense to cause the waterproofing compound used with the wood decking to become generally tacky and in some spots became fine ash. Acetylene and oxygen bottles in the shipfitters shop were displaced but intact.

A fire, probably of secondary origin, occurred in the diving gear locker on the starboard side of the main deck between frames 141-144. The gasoline engine drive for the air compressor located in the compartment has been blown from its foundation and is on the deck. The fuel tanks are burst open. A possible source of this fire, which gutted this compartment and the washroom to starboard, could be the gasoline spread when the fuel lines to the tanks were ruptured. Heat from the fire aft by bulkhead 126, may have ignited this gasoline.

Burned and charred areas at approximately frame 58, port side of the flight deck were caused by the burning of an airplane stowed here. The pontoons of the plane were torn from the plane causing the second burned areas.

An army F-1 trailer has been displaced, from its position on the flight deck near the after elevator, into the elevator well, and is badly charred. The movement is probably the result of the deep starboard roll. The tires are destroyed except for a few charred fibres. Hose, lying near has burned to the canvas casing, and wooden strips are heavily charred. These strips were part of the securing equipment. The source for this fire could have been the fire in the torpedo stowage space.

Although some warheads would be in compartment C-101-E under operating conditions, the normal stowage is the magazines. Warhead and torpedoes in the maga-

SECRET

USS INDEPENDENCE (CVL22)

ready locker's has not been harmed, nor has the gasoline in the regular stowage tanks.

MACHINERY

Fires and secondary explosions occurred in the hangar, on the flight deck aft of frame 50, and in the upper decks near the stern. These burned out the diesel engine of the after casualty power generator, the starboard boat winch, and equipment in the carpenters', shipfitters', and torpedo workshops.

ELECTRICAL

A fire was started in after port quarter from an undetermined cause. All electrical equipment in the burned out areas was completely destroyed by the fire and explosions.

(c) Shock

HULL

There are many conditions of fittings and equipment on this ship which are somewhat characteristic of shock. There are some, although very few electric light bulbs broken. Machinery, such as both catapult elements and the airplane crane, has been shifted from the assigned location. A drinking fountain at frame 27 near the centerline is shifted several inches to port but no connections except the drain are broken. The relatively heavy hot water heater, located in the officers washroom, gallery level, frame 27, has also shifted several inches to port and several of the connections are broken. A large part of the furniture in the gallery and forecastle levels has broken from the footing and shifted generally, but not in all cases, to starboard. Heavier items have broken loose, while lighter units show strain and/are partial failure of securing clips. In the middle portion of the ship, crew's bunks, furniture and galley equipment has shifted to starboard or jumped out of the footings. Some of the above is very likely due to the deep starboard roll of the ship, and some to vibration or whipping but it is not very probable that shock, in the sense implied by impact, played a very distinctive part in the injury to this ship.

SECRET

USS INDEPENDENCE (CVL22)

Page 20 of 280 Pages

There was no damage to machinery that could be specifically attributed to shock.

ELECTRICAL

Some indication of shock on electrical equipment mounted on bulkheads was apparent although not enough equipment was damaged in this manner to substantiate any definite conclusions.

(d) Pressure

HULL

The great bulk of the structural and attendant incidental damage was caused by the pressure wave. The pressure front struck almost normal to the port shell from a source about 225 degrees relative bearing. There are five principal areas of damage:

1. Port side aft of bulkhead 126 above the waterline.
2. The hangar area, including that deck and the flight deck.
3. The port shell forward of bulkhead 126.
4. The port and starboard walkways and island structure including the stacks and uptakes.
5. Interior spaces.

The damage aft of bulkhead 126 and above the waterline was so universal that no critical scantlings could be determined, and it is believed not to be feasible to provide against such damage at the range involved because a ship of this size would not be able to handle the required plating or framing weights.

In the hangar space also, there was no structure which satisfactorily withstood the blast pressures sufficiently well to

SECRET

USS INDEPENDENCE (CVL22)

Page 21 of 280 Pages

Obtain a critical set of scantlings. It is true that the starboard side is usable; but the port side, which took the direct blast and has similar scantlings, is not. There it is a matter of orientation with respect to the blast. The comment that adequate plate and framing weights would probably be too heavy for the ship applies here also.

On the port shell and blister plating, between frames 126 and 50, the plating, which varied from approximately 30# to 15#, was sufficient to keep the structure tight but did not prevent dishing, in most cases, very severe dishing. There was some minor damage to the 12# to 20# plating of the shell forward of frame 50. Although the ship probably could get back to a repair base without trouble from the plating, between frames 50 and 126, there is a definite loss in strength - for which reason the critical scantlings would be somewhat over these provided. The scantlings forward of frame 50 are satisfactory and probably critical for that particular distance and orientation from the burst.

The scantlings of the walkways and island structure may be considered critical in spite of the failures in the port walkway, since the detailed structure of the walkways and gun stations generally is in usable condition. The cause of failures insufficient connection between the walkway and shell of the ship.

Scantlings of interior spaces were satisfactory for the purpose but could not be lightened.

Broadly, the failure was collapse or incipient collapse under the influence of pressures far in excess of those for which the structure was designed. Aft of bulkhead 126 the structure, acting as a series of panels was moved bodily from its assigned location and so badly damaged that collapse was accompanied by boundary failure and tears with the panels. The condition of this area was worsened by fire and low order explosions to the extent that definition of particular types of failure was lost. Forward of 126, panel failures of various degrees are clearly indicated. Columns and other structure within this general region failed, largely in connections as a result of various panel failures. Forward of bulkhead 45 panels indicated incipient failure by light dishing or slight crumpling of the bottoms of stiffeners.

SECRET

USS INDEPENDENCE (CVL22)

Page 22 of 280 Pages

MACHINERY

The blast pressure of the explosion caused the major damage to the stacks, airplane elevators, crane, and some of the damage to piping. This pressure caused failures and deflection of decks and bulkheads which in turn, caused most of the damage to piping. The pressure wave appeared to have come from the port quarter.

ELECTRICAL

Air blast pressure from about 240 degrees relative was indicated throughout the major damaged areas due to the manner in which the structural members on which electrical equipment was supported were ruptured and blown over the side.

- (e) Effects apparently peculiar to the atom bomb.

HULL

Other than the radiant heat there were no effects noticed which are peculiar to the atom bomb.

MACHINERY

The very high magnitude of blast pressure is apparently peculiar to the atom bomb.

ELECTRICAL

The blistering of paint by radiant heat and the presence of radioactive material on exposed surfaces were the effects noted peculiar to the atom bomb.

III. Effect of Damage.

- (a) Effect on machinery, electrical, and ship control.

SECRET

USS INDEPENDENCE (CVL22)

Page 23 of 280 Pages

None, except for crushing of boiler uptakes.

MACHINERY

The ship was left without steam power and hence was immobilized. Temporary repairs to enable the ship to steam at slow speed would require at least 4 days. Damage to gasoline piping would have greatly accentuated the effect of fires and explosions if the ship had been operating under war conditions. Damage to gasoline, firemain, and water curtain piping would have handicapped efforts to fight the fires. The firemain in the hangar and on and above the flight deck level aft of frame 50 was inoperable except for a few connections on the port side. The airplane elevators were left useless as their platforms were blown overboard. The crane is inoperable. The hoisting gear of the crane could have been made operable for emergency use by a tender within about 24 hours, but the rotating gear is probably beyond repair. The port boat winch is missing. The starboard boat winch, the diesel engine of the after casualty power generator, and the carpenters', shipfitters', and torpedo workshops are beyond repair. The refrigerating plant is inoperable but could be made operable by the ship's force within 2 days. The main shafts were believed to be out of alignment making high speed impossible even if boiler power for same were available.

The test had little effect on ship control from a machinery point of view, except to limit power available to that furnished by the two emergency diesel generators and the forward casualty power generator.

ELECTRICAL

No effect on electrical equipment associated with propulsion. Damage to bridge steering selsyn control cable, the loss of approximately three pounds of mercury from each of the master gyro-compasses and complete destruction of navigation lights were the most vital casualties to ship control.

(b) Effect on gunnery and fire control.

SECRET

USS INDEPENDENCE (CVL22)

Page 24 of 280 Pages

Assuming that guns were mounted in all the locations provided, approximately 75% would be inoperable; 50% of the 40MM and all centralized fire control would be lost. Ammunition supply is intact.

MACHINERY

No comment.

ELECTRICAL

Fire control systems and communications were badly damaged and in most cases inoperable due to structural failures rupturing wiring and wiring equipment. The power and control cables to three of the four (4) heavy machine guns were severed under gun mounts when foundations were deflected.

(c) Effects on watertight integrity and stability.

HULL

The hull is non-tight on the second deck aft of bulkhead 57, on the third deck aft of bulkhead 91, and on the first platform aft of bulkhead 113. This lack of watertight integrity is the result of buckling of the bulkheads under the main and second decks. The bulkheads generally buckled first through access door openings, thus leaving the closure warped and incapable of being made tight. Openings in bulkheads for large vent ducts were easily vulnerable because the vent ducts, being weaker than surrounding structure, tended to fail early and have left the bulkhead non-tight. In several instances bulkheads have been torn at hard spots formed by the intersection of structure members. The main deck has a small tear at frame 113 near the centerline, a larger one near the centerline at about frame 122 and one approximately 12 feet long on the port side just aft of frame 132. These are all transverse tears. There is a large fore and aft tear in the main deck, frames 128 to 131. In accordance with present naval practice the bulkheads throughout the mid-length of the ship are tight only to within about 15 inches of the main deck. Below the first platform the ship is tight except for an occasional compartment aft of bulkhead 126. The port shell

SECRET

USS INDEPENDENCE (CVL22)

ment hole at frame 68 has opened one of the blister compartments, B-304-V. At the hangar deck level all ventilation intakes and uptakes have been either blown away or completely ruptured and many of the closure fittings of these systems on the main deck level are distorted. Due to the list, several of the tears in the port shell are lifted out of reach by the swell in the lagoon and the ship is not taking water. At sea, however, she would be subject to progressive flooding within the limits noted which could be dangerous if the damage control crew could not keep the flooding down. Stability has changed very little.

MACHINERY

No comment.

ELECTRICAL

Electrical damage had no effect on watertight integrity.

(d) Effect on personnel and habitability.

HULL

Assuming that the ship was operating as an aircraft carrier with the crew at battle stations, it is probable that fully half her crew would be immediate casualties from the effects of heat, pressure, and radioactivity. Probably a large proportion of the remainder would be subject radiation sickness after several hours or days. Although there is considerable loss in habitability due to reduced ventilation and lighting, and the shifting of galley equipment and furniture, the ship is generally habitable forward of bulkhead 126. Some compartments aft of that bulkhead can be used after considerable cleaning up.

MACHINERY

It is estimated that there would have been no casualties to engineering personnel below decks. Casualties would have been very high among exposed personnel. Habitability was reduced by lack of steam power and general damage to the area exposed to blast pressure and fires.

SECRET

USS INDEPENDENCE (CVL22)

Page 26 of 280 Pages

Electrical damage to living spaces were minor, except to CPO quarters aft, which was completely wrecked. The galleys could be used as soon as the main turbo generators were put in service following restoration of boiler power. The fire and flushing main was operable from diesel power immediately.

(e) Total effect on fighting efficiency.

HULL

The fighting efficiency of the INDEPENDENCE as an aircraft carrier has been reduced to zero.

MACHINERY

The effectiveness of this vessel as an aircraft carrier was reduced to zero, and could not be restored without a major overhaul.

ELECTRICAL

The fighting efficiency would have been zero due to the destruction of or damage to all aircraft handling facilities. Interior communications remained reasonably operable except for the 3 MC and 5 MC systems, which were largely inoperable or demolished.

IV. General Summary of Observers' Impressions and Conclusions.

HULL

The gradation of damage on this ship illustrates the rapid deterioration of pressure as the wave moves out from the center of burst. Study of the ship suggests that had she been just a trifle closer to the burst, she would have been sunk; and, had she been just a trifle further away from the burst, she would have retained at least some, if not all, of her facilities as an aircraft carrier.

SECRET

USS INDEPENDENCE (CVL22)

Page 27 of 280 Pages

It would appear that no aircraft carrier now afloat could withstand an attack of this nature at such close range without serious reduction of her military effectiveness as a carrier. Extensive studies of design features of this type are indicated.

ELECTRICAL

This vessel was subjected to the radiant heat of the bomb followed closely by air blast pressure of considerable magnitude. Due to the proximity of this ship to the bomb burst, the damage suffered was so extensive that it was rendered inoperable as a fighting craft.

The fact that ship's generators, both main and emergency, all switchboards, lights, automatic telephones, telegraphs and the announcing systems (except 3MC and 5MC) were all working in spite of the severe punishment received, certainly shows that the electrical equipment has been well designed to withstand battle damage.

V. Preliminary General or Specific Recommendations of Inspection Group.

HULL

Future designs should eliminate structural discontinuities and provide compensation for all access openings, whether for doors, cables, vent ducts, or pipes. Frames should not be omitted in shell or blister panels. Stress concentrations, whether in corners of hatch openings, brackets, etc., should be reduced to the minimum. Circular vent ducts are preferable to rectangular sections. Door frames should be redesigned so that support will be provided by the panel stiffeners rather than the panel plating. Fifteen pound plating with adequate stiffening should be the minimum employed topside. Curved surfaces in lieu of flat should be used exclusively. Two bomb elevators should be provided in place of one. Automatic closure seals for bomb elevators, uptakes, and trunks should be studied. Overhanging structure and opportunities for the blast to "tunnel" should be eliminated. Vital services piping and cables should be kept below

SECRET

USS INDEPENDENCE (CVL22)

structure, which should be streamlined. All topside operating positions should be completely enclosed, including gun and director stations, and should be streamlined. A study should be made of better methods of securing the elevators.

MACHINERY

Recommendations based on the experience of this vessel are too numerous for all to be listed here. A few of the most important will be mentioned in a general way.

1. Redesign stacks to enable them to better withstand blast pressure, and relocate them so all will not be badly damaged by blast pressure coming from one direction.
2. Study the design and layout of piping to make it better able to withstand this type of attack. In particular, support piping from heavy frames or other structural strength members not likely to fail or be severely distorted.
3. Adopt measures to prevent elevator platforms from being blown overboard or wrecked.
4. Reduce surface area of structural members of deck equipment (such as crane) as much as possible, and round these surfaces. Install the crane machinery in a protected location instead of on the rotating platform.

ELECTRICAL

For installation of electrical equipment such as power and lighting, distribution panels, transfer switches, motor controllers, distribution connections and junction boxes, and similar equipment supported on bulkheads less than 1/2 inch in thickness, "U" bracket foundations fabricated from flat bar and angle bar similar to enclosure sketches CR-1E and CR-2E, as recommended under part C, items F, G, K, and L should be used. When decks and bulkheads are deflected or buckled, the resultant stresses generated would then not be absorbed by the enclosures of the electrical equip-

SECRET

USS INDEPENDENCE (CVL22)

Cable should not be passed through long lengths of conduit and risers through decks should not be attached directly to fixtures, as bends in the conduit and shifting of equipment cause breaks in the cable. The last cable strap supporting the cable before it enters the equipment should be made of very light steel so as to permit it to fail when cable is tensioned.

The present method used to support the sensitive element in Mark VIII, Model 3, Arma compasses definitely will not withstand the effect of shock. It is recommended that the design of the flotation bowl and float be changed to incorporate some means of retaining mercury in the bowl when subjected to shock or rapid vertical acceleration. Use of a close fitting collar with baffles to suppress wave motion in the mercury is suggested. Bowl support springs between inner gimbal ring and outer bowl should either be increased in number or in size and a better method for securing them devised. Compasses on several of the target vessels had these springs greatly elongated or detached allowing the compass unit to fall to the base of the binnacle.

SECRET

USS INDEPENDENCE (CVL22)

Page 30 of 280 Pages

SECTION I - HULL

GENERAL SUMMARY OF HULL DAMAGE

I. Target Condition After Test.

(a) Drafts after test; list; general areas of flooding, sources.

The drafts of 23 feet zero inches forward, and 23 feet six inches aft are unchanged as a result of the test. There was no list before the test and it is now about 5 degrees to starboard. There are several reasons for the list, (1) removal of planes, test gear, and structure from the port side by the blast; (2) shifting of port side weights to starboard, such as catapult machinery, furniture, planes in hangar, hangar side plating, etc.; (3) flooding of starboard shaft alley; (4) movement of hangar bents and flight deck and stern structure about 1 foot toward the starboard side.

(b) Structural damage.

Superstructure. The superstructure on this ship is here considered to be the island structure, the stacks and the radio masts. All pipe frame structure and the platforms supported thereby have been blown down and off the ship by the pressure wave. The stacks have been collapsed and twisted but have remained generally in place. Radio masts have universally been twisted, bent or ripped from their locations. The island structure itself shows some minor dishing of the exposed bulkheads but is intact and usable. Doors on exposed bulkheads are severely dished and are inoperable, and the door at the hangar deck level has been torn from its hinges.

Hull Flight deck. Between the forward edge of the flight deck and bulkhead 45 the damage to the deck is insignificant except for the depressing of the forward edge of the elevator opening. The deck is undistorted and entirely usable. Along the port and starboard sides of the elevator opening there is no perceptible damage. Aft of the forward elevator opening the deck shows the first sign of

SECRET

USS INDEPENDENCE (CVL22)

Page 31 of 260 Pages

the port deck edge rises rapidly, until at the expansion joint at frame 63 1/2 it is several feet above its normal position. The expansion joint has not opened perceptibly from its position before the test. The surface of the deck is in good condition materially except for two small burned areas at about frame 59 where a test airplane was located.

Beginning at the expansion joint, frame 63 1/2, the flight deck is very sharply hipped along the centerline with the wood decking broken, and several feet of the thin steel deck plating below is split. Between the expansion joints at frames 63 1/2 and 84 1/2 the deck, on the starboard side, begins to rise at the deck edge and progresses in a straight line to the hip at the centerline. On the port side between these frames there is little change from the normal position of the deck between the edge and approximately eleven feet inboard of it. From here the deck peaks sharply in a straight line to the hip at the center. In addition to the transverse deformation, the longitudinal run of the deck rises from 63 1/2 in a fair curve to about 7 feet above normal at frame 84 1/2. The sharp peaking disappears at about frame 80 where it fades into a smooth arch which continues past the expansion joint at frame 84 1/2. Except for the splintering of the wood at breaks along the centerline the surface of the deck is in materially good condition.

Between the expansion joints at frames 84 1/2 and 111 1/2 the flight deck drops in a relatively smooth curve from about 7 feet above normal to a generally normal position at 111 1/2. The ridge in this area is more pronounced because the deck maintains its normal position for about nine feet inboard of the deck edge both port and starboard, thus making a much sharper angle of rise. The wood decking here is also splintered and broken and the thin steel plating underneath split over a considerable portion of its length. At approximately frame 95 there is a tear in the steel plate extending across most of the deck.

The aftermost section of the flight deck, frame 111 1/2 to the stern, is badly damaged. Between 111 1/2 and the forward edge of the after elevator opening the deck is about normal. There is a slight depressing of the deck all around the opening, and

SECRET

USS INDEPENDENCE (CVL22)

Page 32 of 280 Pages

a slight rise towards the stern. Aft of the elevator opening and to port of the starboard side of the opening, the deck is not only not usable but is also relatively dangerous for walking. The area is badly burned and heavily distorted to port of the centerline aft of frame 132. The after edge of the deck rises at an angle of approximately 45 degrees on the port side to a point about 20 feet outboard of the centerline. At this point there is a void in the deck, which extends forward to about frame 136. This corner of the deck which has been blown away by the blast, overhung the boundaries of the ship.

The deck is not usable as a carrier deck, and aft of frame 63 1/2 it is not usable for any purpose.

Gallery level walkways. On the starboard side there is little discernible damage, but on the port side the walkways and overhanging gun tubs are either missing or so sharply forced upwards that the positions are useless.

Gallery and forecastle, decks forward of bulkhead 45. Structural damage on these decks is limited to minor distortion of joiner bulkheads and relatively few cases of foundation displacements.

Main deck. There is little damage to the main deck forward of bulkhead 45. From this bulkhead aft, the deck has been forced down in way of both elevators by the pressure wave which entered the hangar space, and in way of the hangar deck by the load transmitted through the transverse and longitudinal floors between the hangar and main decks. The area affected extends aft to bulkhead 126 and about 20 feet each side of the centerline. A maximum depression of 14" in the forward elevator well occurs at frame 53 on the centerline; in the after well the maximum is 15" at frame 122 and approximately nine feet to port. The maximum depression in way of the hangar deck is about fifteen inches, and the average depression throughout this area is about 5". Aft of bulkhead 126 the main deck is badly damaged, especially on the port side. Areas exist wherein the depression of this deck is as much as two feet, and aft of 136, port side, the deck is ripped along the shell and has been folded under itself. On the starboard side of this deck, between frames 126 and 132, fire and low

SECRET

USS INDEPENDENCE (CVL22)

Page 33 of 280 Pages

general havoc throughout the stern of the ship aft of bulkhead 144. This internal source of damage coupled with the direct effect of the atomic bomb burst have made the bulkheads, decks, doors, equipment, furniture, ventilation, and electrical facilities useless.

Second Deck: There is practically no damage to the second deck area from the stem to bulkhead 49. Aft of bulkhead 49, the second deck bulkheads generally buckled from the loading exerted by the main deck, but there is no discernible buckling of bulkheads below the second deck or depression of the second deck forward of bulkhead 101. The deck is depressed slightly between frames 101 and 119 aft of which very severe dishing and distortion of the deck begins, for the most part on the port side where the extreme damage to the port shell has caused long accordion pleats in the deck. Water-tightness throughout this deck aft of bulkhead 49 has been destroyed due to damage to door frames, doors, vent ducts, and cable runs.

Third Deck: There is no damage forward of bulkhead 57 which shows slight buckling. Between 57 and 91, the bulkheads show signs of elastic deflection of the second deck but have retained their tightness. The deck has not been depressed. There is some slight tripping of the port shell frames between frames 91 and 101. Aft of frame 101 the tripping and buckling of the frames becomes very pronounced. Aft of 113 the buckling is very severe and is accompanied by a definite displacement of all port side structure to starboard.

Below Third Deck: There is some slight damage to joiner bulkheads and some loss of water-tightness.

Shell - Starboard Side: The sheer strake, frames 12 to 15, shows local damage caused by service ships when alongside the INDEPENDENCE in the target area. The sheer strake and the strake next below, show a slight herringbone stress pattern at frame 20. The side panelling just above the main deck, frames 30 - 36, is dented and dished from contact with service ships, also in the target area. No other evidence of damage from the test exists between frame 36 and 120 where a deep, wide wrinkle becomes apparent at the main deck and travels diagonally aft to

SECRET

USS INDEPENDENCE (CVL22)

Page 34 of 280 Pages

diagonal panel depressions, running in the direction, which continue to the stern. The side panelling aft of bulkhead 126 and above the main deck is blown out as a result of damage in the torpedo workshop.

Shell - Port Side: There is only the faintest suggestion of panel dishing between the stem and frame 40. In the neighborhood of frame 40, there is some scorching of paint and the beginnings of discernible panel dishing which increases in severity to frame 50, where individual panel failures become apparent. At frame 70, traces of the blister longitudinals appear and continue to frame 106 with the depressions between them reaching maximums of about 18 inches at approximately frame 95. Longitudinal dishing of the blister plating is evident to frame 112. Between frames 112 and 126 the disformation of the shell is severe but varied. Aft of bulkhead 126 the wilted appearance of the port side, both above and below the main deck, bears striking witness to the tremendous force of the attacking instrument. The original character of the side plating and companion structure can be determined between frames 126 and 134 above the main deck although it is badly mauled. Between the main and third decks the shell is relatively smooth from frame 126 to 134 but shell plating and framing have been forced to starboard slightly leaving the third deck clearly defined. Below the third deck from 126 to 134 there is a deep depression giving the appearance of collision damage - which is, however, due to lack of adequate framing in this area. Aft of frame 134, above the main deck, the side plating and structure is generally collapsed to frame 144. Below the main deck the sheer strake is torn as is the connection between the main deck and the sheer strake. The shell plating has been pushed to starboard and down, almost to the third deck, with deep valleys existing between the framing. The transom between the port side and centerline has collapsed and the main deck droops over the wreckage aft of 134.

Hangar Space: All but three of the light cover plates between the heavy port side columns, which support the flight deck, have been blown out; some across to the starboard side of the hangar and some overboard. The columns, with the exception of those just forward and aft of the expansion joints, have been generally inclined slightly to starboard at the top, bent slightly

SECRET

USS INDEPENDENCE (CVL22)

Page 35 of 280 Pages

have been ripped from the deck at their riveted connections to the hangar deck and definitely deformed. The light cover plates on the starboard side are less affected by the blast, about half remaining in place. The main columns on the starboard side, with one or two exceptions, show no effect of the blast. Most of the "wobble bent" columns offer only a little evidence of the tendency to lift which characterized the action of those on the port side. Both elevators have been carried over the side, bulkhead 45 is deeply dished in horizontal valleys between the forward decks, bulkhead 126 is bulged into the hangar space, and the hangar deck is deeply dished, between the longitudinal floors from frame 56 to 115. The maximum depth of this dishing occurs along the centerline at frame 89 and amounts to 15".

(c) Other damage.

All steam machinery below the third deck is operable if steam can be supplied. All uptakes are collapsed above the hangar deck and temporary uptakes and temporary exhaust ducts must be provided before the boilers can be lighted off. The diesel plant consisting of two 150 k.w. generators is operable. The ship control station on the bridge is operable, as is the ship control station at the forward end of the port gallery walkway. Electric lighting circuits below the main deck, aft of bulkhead 45, and all circuits forward of bulkhead 45 will require only minor repairs - a few hours work by ship's force - before operation is possible. Telephones and loudspeakers are in approximately the same condition although here are some scattered phones in heavily damaged areas, which are now operable. The steering gear is operable and can be controlled from both main and secondary stations. Gyros and repeaters, in general, are operable. The anchor windlass is operable. Fire control equipment is generally not operable. Below decks electronic equipment is practically all operable, while radars and other topside electronic equipment is disabled. Not all guns normally aboard the ship were in place for the test. The remaining guns on the port side are not operable; but, those on the starboard side, except the one furthest aft, and those in the forecastle are operable. Arresting gear sheaves and barrier stanchions on the flight deck appear to be intact and are generally operable, but the

SECRET

USS INDEPENDENCE (CVL22)

Page 36 of 280 Pages

between elevators, dropped to the hangar deck because of failure of the supporting bolts when the flight deck buckled. Such hydraulic gear located aft of bulkhead 126 remained in place, but was seriously damaged from fire and distortion of the supporting structure. The elevators were blown off the ship but the elevator machinery appears to be intact except for entangled wire and a few dislocated sheaves. Upper sheaves around the elevator openings in the flight deck are warped and out of alignment. The airplane crane is not operable, being off its roller path and is cocked to starboard about 15 degrees and 10 degrees forward. The bushings, bearings, and holding down clips are marred, gouged, and somewhat mangled, but the ship's force should be able, with a few days work, to repair and reseal the crane for use. Except for electrical connections the hoisting machinery is intact and usable. The training "A" end is intact but the "B" is shifted slightly, and is inoperable. The starboard catapult accumulator bottle has shifted about 1" to starboard and opened some of the oil line flanges. This catapult can be returned to service very quickly. The port catapult electric motor and pump have been displaced about 6" to port, oil lines are broken and gauge and control panels displaced to starboard. The catapult is inoperable and is not susceptible to quick repair. All four radio masts were in the up position for this test and were blown to starboard, generally folding over the flight deck edge. Their operating machinery was deranged due to general buckling of all structure along the gallery walkway.

II. Forces Evidenced and Effects Noted.

(a) Heat.

The entire flight deck is very noticeable darkened, apparently from the heat of the blast; curved surfaces indicate a source approximately broad on the port beam and shadows support the conclusion that the relative bearing of the burst was about 225 degrees. All surfaces facing the burst are darkened and there is some scorching of paint on the inboard (port) side of the island structure. Some piping in this area shows slight blistering. There is no damage to interior paints. Paint on planes in the hangar show but slight scorching and in many cases none at all. Some manila line was scorched to approximately 1/32" depth. Cloth seam tape and the olive drab paint on an army portable radar unit are completely gone on the side exposed to the blast

SECRET

USS INDEPENDENCE (CVL22)

There were severe fires and low order detonations but no violent explosions.

The port side aft was blown inward by the A-bomb burst, exposing about six compartments containing some bedding, and a small amount of lumber in the shipfitter and aviation metalsmith's workshops. There was undoubtedly, some acid and paint in these shops, in the battery repair shop, and in the torpedo workshop. Some of the materials in the shops, which were open to each other and to the weather - from the effect of the blast - caught fire, either from the heat of the burst or from a source which may never be determined. This fire spread through practically all compartments aft of bulkhead 126 and above the main deck and into compartment C-204-L on the 2nd deck between bulkheads 126 and 132. About 1436 on "A" day, the fire reached the twelve torpedo warheads in compartment C-101-E on the starboard side of the main deck between frames 126 and 132. There were air flasks in the compartment and at least one Mk. 24 mine. It is, of course, impossible to establish an exact order of events within the compartment, but it seems probable that the heat of the fire approaching the compartment raised the temperature sufficiently to cause exudation of the warhead filler. This filler would burn fiercely, thus causing a further increase in temperature within the compartment which probably caused the torpedo air flasks to explode. Torpedo air flasks were ruptured and the propellers and tail piece of the Mk. 24 mine was found as a fragment in the compartment. The smoke and flash patterns on "A" day showed a series of burst and flashes compatible with repetitive burning of exudate and failure of air flasks. All the material in the compartment appeared to be burning about 1400 as the smoke was most intense and voluminous. This fire was extinguished on the morning of "A" plus 1 day. This flurry blew out part of bulkhead 126, ripped the starboard shell practically the full length of the compartment, blew up the overhead and ripped the main deck - thus, spreading the fire into compartment C-204-L where bedding and shoring timbers burned. The heat from this general conflagration aft of bulkhead 126 caused the smoldering and then burning of the wood covering of the flight deck. The heat was sufficiently intense to cause the water-proofing compound used with the wood decking to become generally tacky and in some spots became fine ash. Acetylene and oxygen bottles in the shipfitters shop were displaced but intact.

SECRET

USS INDEPENDENCE (CVL22)

Page 38 of 280 Pages

the diving gear locker on the starboard side of the main deck between frames 141-144. The gasoline engine drive for the air compressor located in the compartment has been blown from its foundation and is on the deck. The fuel tanks are bursted open. A possible source of this fire, which gutted this compartment and the washroom to starboard, could be the gasoline spread when the fuel lines to the tanks were ruptured. Heat from the fire aft by bulkhead 126, may have ignited this gasoline.

Burned and charred areas at approximately frame 58, port side of the flight deck were caused by the burning of an airplane stowed here. The pontoons of the plane were torn from the plane causing the second burned areas.

An army F-1 trailer has been displaced, from its position on the flight deck near the after elevator, into the elevator well, and is badly charred. The movement is probably the result of the deep starboard roll. The tires are destroyed except for a few charred fibres. Hose, lying near has burned to the canvas casing, and wooden strips are heavily charred. These strips were part of the securing equipment. The source for this fire could have been the fire in the torpedo stowage space.

Although some warheads would be in compartment C-101-E under operating conditions, the normal stowage is the magazines. Warhead and torpedoes in the magazines were not damaged nor were those on planes. Ammunition in ready lockers has not been harmed, nor has the gasoline in the regular stowage tanks.

(c) Shock.

There are many conditions of fittings and equipment on this ship which are somewhat characteristic of shock. There are some, although very few electric light bulbs broken. Machinery, such as both catapult elements and the airplane crane, has been shifted from the assigned location. A drinking fountain at frame 27 near the centerline is shifted several inches to port but no connections except the drain are broken. The relatively heavy

SECRET

USS INDEPENDENCE (CVL22)

Page 39 of 280 Pages

not water heater, located in the engine room, gallery level, frame 27, has also shifted several inches to port and several of the connections are broken. A large part of the furniture in the gallery and forecastle levels has broken from the footed and shifted generally, but not in all cases, to starboard. Heavier items have broken loose, while lighter units show strain and/or partial failure of securing clips. In the middle portion of the ship, crews bunks, furniture, and galley equipment has shifted to starboard or jumped out of the footings. Some of the above is very likely due to the deep starboard roll of the ship, and some to vibration or whipping but it is not very probable that shock, in the sense implied by the impact, played a very distinctive part in the injury to this ship.

(d) Pressure.

The great bulk of the structural and attendant incidental damage was caused by the pressure wave. The pressure front struck almost normal to the port shell from a source about 225 degrees relative bearing. There are five principal areas of damage:

1. Port side aft of bulkhead 126 above the waterline.
2. The hangar area, including that deck and the flight deck.
3. The port shell forward of bulkhead 126.
4. The port and starboard walkways and island structure including the stacks and uptakes.
5. Interior spaces.

The damage aft of bulkhead 126 and above the waterline was so universal that no critical scantlings could be determined, and it is believed not to be feasible to provide against such damage at the range involved because a ship of this size would not be able to handle the required plating or framing weights.

SECRET

USS INDEPENDENCE (CVL22)

which satisfactorily withstood the blast pressures sufficiently well to establish a critical set of scantlings. It is true that the starboard side is usable; but the port sides which took the direct blast and has similar scantlings, is not. There is a matter of orientation with respect to the blast. The comment that adequate plate and framing weights would probably be too heavy for the ship applies here also.

On the port shell and blister plating, between frames 126 and 50, the plating, which varied from approximately 30# to 15#, was sufficient to keep the structure tight but did not prevent dishing; in most cases, very severe dishing. There was some minor damage to the 12# to 20# plating of the shell forward of frame 50. Although the ship probably could get back to a repair base without trouble from the plating, between frames 50 and 126, there is a definite loss in strength - for which reason the critical scantlings would be somewhat over those provided. The scantlings forward of frame 50 are satisfactory and probably critical for that particular distance and orientation from the burst.

The scantlings of the walkways and island structure may be considered critical in spite of the failures in the port walkway, since the detailed structure of the walkways and gun stations generally is in usable condition. The cause of failures is insufficient connection between the walkway and shell of the ship.

Scantlings of interior spaces were satisfactory for the purpose but could not be lightened.

Broadly, the failure was collapse or incipient collapse under the influence of pressures far in excess of those for which the structure was designed. Aft of bulkhead 126 the structure, acting as a series of panels was moved bodily from its assigned location and so badly damaged that collapse was accompanied by boundary failure and tears within the panels. The condition of this area was worsened by fire and low order explosions to the extent that definition of particular types of failure was lost. Forward of 126, panel failures of various degrees are clearly indicated. Columns and other structure within this general region failed, largely in connections as a result of the various panel failures. Forward of bulkhead 45, panels indicated incipient failure by light

SECRET

USS INDEPENDENCE (CVL22)

Page 41 of 280 Pages

There was a minor amount of displacement of equipment and machinery.

- (e) Any effects apparently peculiar to the atom bomb.

Other than the radiant heat there were no effects noticed which are peculiar to the atom bomb.

III. Effects of Damage.

- (a) Effect on machinery, electrical and ship control.

None, except for crushing of boiler uptakes.

- (b) Effect on gunnery and fire control.

Assuming that guns were mounted in all the locations provided, approximately 75% would be inoperable; 50% of the 40MM and all centralized fire control would be lost. Ammunition supply is intact.

- (c) Effects on watertight integrity and stability.

The hull is non-tight on the second deck aft of bulkhead 57, on the third deck aft of bulkhead 91, and on the first platform aft of bulkhead 113. This lack of watertight integrity is the result of buckling of the bulkheads under the main and second decks. The bulkheads generally buckled first through access door openings, thus leaving the closure warped and incapable of being made tight. Openings in bulkheads for large vent ducts were easily vulnerable because the vent ducts, being weaker than surrounding structure tended to fail early and have left the bulkhead non-tight. In several instances bulkheads have been torn at hard spots formed by the intersection of structure members. The main deck has a small tear at frame 113 near the centerline, a large one near the centerline at about frame 122 and one approximately 12 feet long on the port side just aft of frame 132. These are all transverse tears. There is a large fore and aft tear in the main deck, frames 128 to

SECRET

USS INDEPENDENCE (CVL22)

Page 42 of 280 Pages

131. In accordance with present naval practice the bulkheads throughout the mid-length of ship are tight only to within about 15 inches of the main deck. Below the first platform the ship is tight except for an occasional compartment aft of bulkhead 126. The port shell is generally open aft of bulkhead 132 above the third deck. The fragment hole at frame 68 has opened one of the blister compartments, B-304-V. At the hangar deck level all ventilation intakes and uptakes have been either blown away or completely ruptured and many of the closure fittings of these systems on the main deck level are distorted. Due to the list, several of the tears in the port shell are lifted out of reach by the swell in the lagoon and the ship is not taking water. At sea, however, she would be subject to progressive flooding within the limits noted which could be dangerous if the damage control crew could not keep the flooding down. Stability has changed very little.

(d) Effect on personnel and habitability.

Assuming that the ship was operating as an aircraft carrier with the crew at battle stations, it is probable that fully half her crew would be immediate casualties from the effects of heat, pressure, and radioactivity. Probably a large proportion of the remainder would be subject to radiation sickness after several hours or days. Although there is considerable loss in habitability due to reduced ventilation and lighting, and the shifting of galley equipment and furniture, the ship is generally habitable forward of bulkhead 126. Some compartments aft that bulkhead can be used after considerable cleaning up.

(e) Total effect on fighting efficiency.

The fighting efficiency of the INDEPENDENCE as an aircraft carrier has been reduced to zero.

IV. General Summary of Observers' Impressions and Conclusions.

The gradation of damage on this ship illustrates the rapid deterioration of pressure as the wave moves out from the center of burst. Study of the ship suggests that had she been just a trifle closer to the burst she would have been sunk; and, had she been just a trifle further away from the burst, she would have re-

SECRET

USS INDEPENDENCE (CVL22)

Page 43 of 280 Pages

carrier.

V. Preliminary General or Specific Recommendations of the Inspecting Group.

Future designs should eliminate structural discontinuities and provide compensation for all access openings, whether for doors, cables, vent ducts, or pipes. Frames should not be omitted in shell or blister panels. Stress concentrations, whether in corners of hatch openings, brackets, etc., should be reduced to the minimum. Circular vent ducts are preferable to rectangular sections. Door frames should be redesigned so that support will be provided by the panel stiffeners rather than the panel plating. Fifteen pound plating with adequate stiffening should be the minimum employed topside. Curved surfaces in lieu of flat should be used exclusively. Two bomb elevators should be provided in place of one. Automatic closure seals for bomb elevators, uptakes, and trunks should be studied. Over-hanging structure and opportunities for the blast to "tunnel" should be eliminated. Vital services piping and cables should be kept below decks even at the expense of convenience. Where this is not possible, they should be split and each branch protected by extra heavy structure, which should be streamlined. All topside operating positions should be completely enclosed, including gun and director stations, and should be streamlined. A study should be made of better methods of securing the elevators.

VI. Instructions for Loading the Vessel Specified the Following:

ITEM

Fuel oil	33 1/3 %
Diesel oil	33 1/3
Gasoline	33 1/3
Ammunition	66 2/3
Potable and reserve feed water	95
Salt water ballast	950 tons

SECRET

USS INDEPENDENCE (CVL22)

Page 44 of 280 Pages

items aboard are included in Report # 1, Stability Inspection Report, submitted by the ship's force in accordance with "Instructions to Target Vessels for Tests and Observations by Ship's Force" issued by the Director of Ship Material. This report is available for inspection in the Bureau of Ships Crossroads Files.

SECRET

USS INDEPENDENCE (CVL22)

Page 45 of 280 Pages

A. General Description of Hull Damage.

(a) Overall condition of vessel.

The INDEPENDENCE is so heavily damaged by Test A that she should be considered a total loss, for combat purposes, until extensive repairs can be affected.

(b) General areas of hull damage.

She was approximately 600 yards, bearing 225 degrees relative, from the point of burst. The areas affected, and the disparity in degree of damage, follow naturally from her position in the array.

The shell, port side, suffered severe disruption, above and below the main deck, between the transom and frame 125. The shell between frames 125 and 115, and the blister side plating between frames 115 and 70, are deeply dished above the third deck. The dishing diminishes so rapidly forward of frame 70 that no structural impairment which can be assessed as bomb damage is apparent forward of frame 40.

The starboard sheer strake at frame 15 and the side paneling above the main deck, frames 30 - 36, show evidence of local injury from ships coming alongside, probably in the target area. There is a deep wrinkle running from about frame 120 at the main deck to the waterline at frame 127. Shear ripples are prominent along the waterline aft of frame 126.

That portion of the superstructure above the bridge level probably went over the starboard side as no sign of it was noted during any of the examinations after Test A. Ship control instruments on the bridge are operable. Only minor damage was inflicted on the gallery walkways on the starboard side, but the port side walkways aft of frame 29 are useless as a result of the severe damage sustained.

SECRET

USS INDEPENDENCE (CVL22)

Page 46 of 280 Pages

side, is on the roller path. Both forward and after elevators placed in position with the flight deck for the test were blown overboard. All test gear stowed on the flight deck, with the exception of one Army truck, has been blown overboard or into the elevator pits. Between the elevator openings, the flight deck is peaked sharply along the centerline and humped to approximately seven feet above its normal position at frame 86. At frame 95 the flight deck plating and supporting longitudinals have separated, the opening extends athwartship from port to starboard deck edge. Concomitant failure of the flight deck in the vicinity of the columns supporting the deep flight deck girders is indicated by splintering of the wood decking in lines paralleling the port and starboard edges of the flight deck. Aft of the after elevator the wood decking is widely burned, the deck is severely twisted and a large portion of the port corner is missing.

The gallery deck, just forward of bulkhead 45, is a jumble of metal joiner bulkheads and furniture. The derangement decreases rapidly forward of frame 40 and there is little disturbance of equipment along bulkhead 18. The disarray on the fore-castle deck generally resembles that on the gallery deck.

Aft of bulkhead 126, the interior gallery walkways, poop deck, and bulkheads are masses of scrap metal which are so badly mangled and interwoven that immediate recognition of significant compartment structure is impossible.

Little significant damage exists on the main deck forward of bulkhead 45. In way of the forward elevator, frames 45 to 56; the hangar deck, frames 56 to 115; and the after elevator, frames 115 to 126, the main deck is depressed in varying degree. Aft of bulkhead 126, havoc on the main deck is approximately equivalent to that existing in the region above it.

The hangar deck and hangar space, located between frames 45 and 126, exhibit by far the most significant and, from the operational effect on the ship, the most serious mutilation. Here, the hangar deck is generally dished between the deep longitudinals with hollows being especially accentuated on the port side, and generally diminishing in magnitude from aft, forward.

SECRET

USS INDEPENDENCE (CVL22)

Page 47 of 280 Pages

by the force of the blast. It is noticeably less impaired by the blast itself, than the hangar side plating, port, which has been almost completely demolished by the pressure wave. The transverse and longitudinal deep floors under the hangar deck are severely buckled and the load imparted to these floors contributed to the depressing of the main deck.

In way of the elevators, the main deck, which is the bottom of the elevator well, is noticeably depressed and locally torn. The flight deck girders are, in general, severely distorted and in many instances are broken along the centerline of the ship. The flight deck longitudinal beams are twisted and in some instances are torn from the deep transverse girders. The columns of the fixed bents are severely twisted and bowed. The wobble bent columns on the port side are, without exception, torn from the deck.

The compartments on the second deck, aft of bulkhead 45, reflect the general depression of the main deck. The main and metal joiner bulkheads are buckled, and the watertight closures are ineffective.

The second deck from bulkhead 50 is slightly depressed at the bulkheads as far aft as bulkhead 113. Aft of bulkhead 113 the depression becomes general and is augmented by severe deformation on the port side.

The compartments on the third deck, aft of bulkhead 91, was not tight, and main and metal joiner bulkheads are buckled. Compartments on the port side, aft of bulkhead 119, reflect the progressively severe punishment taken by the side of this ship.

Compartments in the first platform aft of bulkhead 113, show minor structural damage resulting from the strain transmitted from the more heavily damaged area of the port shell and third deck overhead.

(c) Apparent causes of damage in each area.

The principal cause of damage in all affected areas was

SECRET

USS INDEPENDENCE (CVL22)

Page 48 of 280 Pages

loss overside of some of the test items from the flight deck, can be attributed to the deep starboard roll recorded by the ships clinometer. Secondary damage, aft of bulkhead 126, was caused by fire of unknown origin, which spread into the torpedo workshop on the main deck between frames 126 and 132 and caused burning of the warheads and possible explosion of the torpedo air flasks.

(d) Principal areas of flooding with sources.

Flooding was negligible and occurred only in the starboard shaft alley from seepage through the stern tube. The amount of water taken aboard caused no perceptible change in the draft of 23 feet, forward; and 23 feet, 6 inches, aft; which were recorded before Test A. There was no list before, and approximately 5° to starboard after the test. The shifting of structural and equipment weights was responsible for the list.

(e) Residual strength, buoyancy and effect of general condition of hull on operability.

The ship has suffered definite and serious reduction in strength and buoyancy. The ship's girder has been weakened by depression of the hanger, main, second and third decks; by severe dishing of the port shell; by tears in port and starboard shell, and by a softening of the middle body structure through local buckling of bulkheads and stanchions.

Her ability to maintain buoyancy has deteriorated in several categories, i.e., by rupturing of the port and starboard shell above the third deck, buckling of bulkheads on the second deck, aft of bulkhead 45, and aft of bulkhead 71 on the third deck; loss of closure integrity due to injury to door frames and doors, and rupture of ventilation systems on the second and third decks.

B. Superstructure. (exclusive of gun mounts).

(a) Description of damage, giving important dimensions.

SECRET

USS INDEPENDENCE (CVL22)

fense level were blown overboard. This structure is shown on pages 3, 4, 5, and 7 which are photographs taken before the test. The condition after the test may be seen on pages 8, 10 and 162 - 166, inclusive. The structural box, comprising the balance of the "Island", is constructed of 20# plate welded to 5" I-beam stiffeners spaced 24 inches apart. The air defense level, a walkway around the "Island" fourteen feet above the flight deck and fabricated on 15# plating, is usable despite the 12" upward displacement of the Air Officers portion of the walkway which is over the flight deck. Photographs on pages 164 and 165 illustrate the condition of the outer face of the air defense level bulwark, particularly the comparatively mild deformation of the bulwark and the serrated pattern imparted to the venturi screen. Photographs 1881-1 and 2, pages 752 and 753 are views of the ship control station, which was operable. It is reasonable to assume that the local damage to the brass disc steering wheel, shown in these photographs, is the result of impact of flying debris. One pelorus stand on this level is broken near the deck. There are no apparent fractures in the "island", but the port side and after panels of the structure are generally depressed, albeit very slightly. Page 34 shows absence of damage to the starboard side of the "island" structure.

Furniture and instruments inside of the structure are deranged and all doors in the island are blown inwards. Paint on the island is generally scorched or blistered where not protected by intervening structure.

The stacks above the flight deck are crushed and blown to starboard but, except where struck by flying fragments, they remain generally in place. Photographs on pages 154 and 155 show remains of the stacks.

All radar and supporting structure along the port and starboard sides of the flight deck are bent and broken.

(b) Causes of damage in each area.

The air blast from the port quarter caused all of the above damage, being either the direct primary agent or the initiating agent for secondary damage such as flying missiles.

SECRET

USS INDEPENDENCE (CVL22)

Page 50 of 280 Pages

There was no fire in the superstructure.

(d) Estimate of relative effectiveness against heat and blast of various plate thicknesses, surfaces, shapes, and construction materials.

1. There is insufficient variety in plating weights in the superstructure to permit a reasonable estimate of a satisfactory minimum thickness. The 15# and 20# plates were satisfactory.

2. Since all surfaces are flat and all construction rectangular, no comparisons are possible here.

3. There does not appear to be any significant difference in the effectiveness of M.S. or S.T.S.

4. There are no aluminum shapes or plates on the superstructure.

(e) Constructive criticism of superstructure design or construction, including important fittings or equipment.

The performance of the superstructure precludes any justifiable suggestions for improvements on this type of ship, other than repeating the conviction that presently exposed stations should be enclosed by plating of minimum weight of 15#. Since the most important loss of equipment in the superstructure above the bridge is the radar, it is suggested that the problem of designing against such loss be studied.

C. Turrets, Guns and Directors.

(a) Protected mounts.

Not applicable.

(b) Unprotected mounts.

1. The port side 40mm and 20mm guns are not operable due, in part, to the deformation of the gun tubs and walkways. Such

SECRET

USS INDEPENDENCE (CVL22)

The after starboard gun is out of the trunnion, but the mount and tub are usable. As a matter of record it should be noted that several of the guns, both port and starboard, on the INDEPENDENCE were removed before Test A. Judging from the effect on guns which were aboard, it appears certain that, on similar vessels, all guns exposed on the side attacked by an atomic bomb would be inactive. Also it appears probable that at least half of those on the unattacked side would be inactivated.

2. The existing shelters on this ship offer inadequate protection because of the thin plating employed in construction, the distance from the gun position, and lack of closures to the shelters. No shelters could have absorbed the force of the blast received by this ship on the port quarter.

(c) Director and rangefinders.

There were four directors placed on this ship for the test. All of them are still in place but are not operable. The sights are bent and/or broken, and the glasses are broken.

(d) Constructive criticism of design or constructions of mounts, directors, foundations, and shelters.

The 20mm and 40mm guns and associated directors were located in tubs along the port and starboard walkways at the gallery deck level. Although many of these guns and directors were removed during the preparation of this ship for the test, it is possible to state that all port guns would be inoperable. It is also reasonable to assume that all stern guns and the guns and directors located in the after half of the starboard walkway would be inoperable. Gun crews at the stern and along the port side would have been directly exposed to the heat wave, shock, pressure wave and radioactivity. Those along the starboard side could have had some measure of protection from the flight deck.

SECRET

USS INDEPENDENCE (CVL22)

Page 52 of 280 Pages

must be made between the loss in fire coverage and the probability of personnel loss.

If the loss of personnel is accepted, the principal structural problem is that of adding sufficient metal to hold the geometrical position of gun tubs and walkways against direct and reflected pressure. Test A demonstrated by the severe upsetting of port side gun tubs and walkways that reflected pressure in a potent force against overhanging structures. See page 59. Consequently, such alterations of this kind as are undertaken on existing ships should fair the overhanging structure into the hull as completely as is consistent with the time and funds available.

If personnel are to be given the greatest available protection, completely enclosed gun positions must be provided and loss of fire coverage compensated for by additional positions. These positions should be streamlined and enclosed by materials capable of withstanding heat and blast pressure. Access to such completely enclosed positions should be only from inside the hull - thus eliminating the relatively fragile walkways. Such a change in concept could most readily be made in new carriers where full advantage could be taken of the opportunity to eliminate overhangs by judicious fairing of the hull from waterline shape to flight deck airstrip shape.

D. Torpedo Mounts and Depth Charge Gear.

None installed.

E. Weather Deck.

Flight deck.

(a) General condition of deck and causes of damage.

This discussion is limited to the plane of the flight deck, the deck covering, and the deck and elevator fittings. The behavior of the transverse girders and longitudinal beams supporting the flight deck is reserved for the discussion covering the hangar space, deck and fittings.

SECRET

USS INDEPENDENCE (CVL22)

Page 55 of 280 Pages

scorched and the painted frame numbers are blackened either from the heat or smoke.

The flight deck is divided into four areas by expansion joints at frames 63 1/2, 84 1/2 and 111 1/2.

Plate No. 4 is based on survey measurements of the flight deck, before and after the test, and shows that there was relatively little movement of the edges of the flight deck, particularly in the horizontal plane. The edges forward of frame 63 1/2 and aft of 111 1/2 appear to have held position very well. The starboard edges of the two middle sections are very nearly in line. The variation shown by the port edges of the two middle sections is due primarily to the deformation of the vertical columns beneath, although there is some evidence of a small clockwise twisting of the middle sections. Such evidence is; twisting in the columns of the flight deck bents, the unequal opening of the expansion joint at frame 111 1/2, and the slight starboard translation of the deck at frame 63 1/2. Plate 4 also shows the vertical displacements of the port and starboard deck edges is greatest at the expansion joints, these being in way of the wobble bent columns. It is significant that there is little vertical displacement at the starboard edge where the wobble columns generally held well but is very pronounced on the port side where the wobble columns tore loose. The slight movement starboard is attributed to the slight lifting of the pads under the starboard columns. The centerline of the flight deck is sharply peaked between the elevators from blast pressure which entered the hangar space through the port side. Detail discussion of the four areas follows:

Area 1. Forward edge of flight deck to frame 63 1/2.

This is the least affected portion of the deck, and appears to be flat and usable forward of frame 30, except for a distinct gouge in the wood decking at frame 26, about 3 feet inboard of the starboard deck edge. The decking in this area is splintered and suggests impact damage by flying debris. Photographs on pages 168 and 169 show the flight deck forward of frame 35. Between frames 30 and 43, there is a faint wave pattern running along the port side of the deck outboard of the elevator opening although the

SECRET

USS INDEPENDENCE (CVL22)

Page 54 of 280 Pages

opening on the starboard side, remains sensibly true as far aft as frame 56. The connections of the island to the flight deck are uniformly good. See photograph on page 162. Along the lower margin of this photograph to right of center, can be seen indications of a depression which extends transversely across the elevator opening between frame 40 and 45 and attains a maximum magnitude of approximately 9" on the centerline at the opening. This depression originates in the extremely deep deformation of the upper panel of bulkhead 45. See photographs on pages 265 and 266. From the after edge of the elevator to the expansion joint at frame 63 1/2, the deck has been distinctly bowed by pressure in the hangar space. The photograph on page 166 shows this condition very clearly. The photographs on pages 175 and 176 are general views of this area, looking aft, and indicate a gradual rise in the deck from starboard towards port, along the expansion joint. The condition of the port side of the deck outboard of the elevator opening can be seen in the photograph on page 175 which illustrates, also, the sharp break at the deck edge at frame 58; resulting, in a displacement of four feet from the normal position at the expansion joint. Page 178 is an excellent portrayal of the general configuration of the deck. The photograph on page 185 portrays, generally, the condition of the deck in the vicinity of the expansion joint, port side. The photograph on page 191 shows this area as seen looking forward from frame 70. Although this photograph was taken after Test B there was no apparent change as a result of that test. The photograph on page 186 details the 4 foot by 3 foot burned area at frame 58 and indicates considerable charring in this region. The airplane which had been located on this section of the deck was partially destroyed by fire and is probably the source of this damage. Pages 162 - 186 and 219 - 222 are views of this area.

Area 2.

Between the expansion joints at frames 63 1/2 and 84 1/2 the deck is sharply peaked along the centerline and the wood decking is fractured at the peak. The ridge at frame 63 1/2 is approximately 4 1/2 feet above the normal plane of the deck. From this position at frames 63 1/2 it drops slightly to approximately 3 feet, 10 inches, at frame 70 and then rises to 6 feet above normal

SECRET

USS INDEPENDENCE (CVL22)

at the deck edge as pages 224 and 225 show it does starboard, but in the vicinity of the hangar bent columns, as is indicated by splintering of the wood decking in lines which approximately parallel the deck edge. The photograph on page 195 shows two fracture lines, the inboard of which occurs approximately 11 1/2 feet inboard of the port edge and is sensibly directly over the inboard toe of the heavy brackets below. The outboard fracture is, by measurement, approximately 30' from the inboard line and agrees very well with conditions shown on page 228 which applies to the starboard side aft of frame 84 1/2. This fracture line ceases abruptly at frame 80 where a definite transverse break in the deck occurs as shown in photographs on page 192 and page 195. From the deck edge, which is about one foot above normal at the expansion joint, the deck on the port side aft of frame 80 rises to the ridge in a relatively fair curve. The joints in the end plates of the expansion joint at frame 63 1/2 and in the plates covering the deck openings are broken and separated as shown in photographs on pages 189 and 190. Pages 187 - 196 and 223 - 227 are views of this area.

Area 3.

The condition of this area is similar to, but somewhat worse than, that in Area 2. The starboard corner is down about 7 inches below normal at frame 86. Between the expansion joint and frame 88, starboard, the deck risers to the peak from the deck edge. Page 224 shows a definite change in contour at frame 88. Aft of this frame there is clear evidence on pages 153, 201, 202, 224, and 228 of a fracture pattern paralleling the deck edge, port and starboard, approximately 9 feet distant from it and similar to that occurring in Area 2, port side. The peaking is more pronounced, being 6' - 10" at frame 84 1/2, 6' - 10" at frame 90, 5' - 11" at frame 100 and decreases in a smooth curve to 2' - 6" above normal at frame 111 1/2. The wood and steel deck are broken and separated, transversely at frame 95 from 9 feet inboard of the port deck edge to 9 feet inboard of the starboard deck edge. See photographs on pages 201, 202 and 228 for views of this deck separation. Pages 198 - 207 and 228 - 229 are views of this area and the expansion joint at frame 111 1/2. A 10,000 gallon gasoline storage tank which weighed approximately three tons was installed on the

SECRET

USS INDEPENDENCE (CVL22)

Page 56 of 280 Pages

Area 4.

The photographs on pages 150 and 151 show very clearly the condition of this area. The expansion joint at frame 111 1/2, between areas 3 and 4 is open about 8'' on the starboard side and about 22'' on the port side. Due to the tipping of area 4 from the force of the blast on the port quarter, the port side deck edge is raised about 14'' and the starboard side is down approximately 1''. The force of the blast pushed area 4 about 6'' to starboard with respect to area 3. Page 151 shows that the deck between the expansion joint and the forward edge of the elevator opening is in good condition except for some irregularity of contour. This area of the deck is not peaked but showed the effect of the force from below which caused the peaking of areas 2 and 3. The starboard side of the deck, in way of the elevator opening, is in good condition. The port side of the deck in way of the elevator opening is slightly depressed, due to partial collapse of the longitudinal beam below, and there is considerable splintering and loosening of the wood deck covering. These effects may be seen on pages 207, 208 and 209. The area affected which also contains a hole in the steel deck about 1 foot wide, centers at about frame 119. Chocks for the after wheels of the water trailer, which was located here, appear to be intact and indicate that the trailer jumped out of the chocks. Aft of the elevator opening the starboard deck edge appears true although the after corner is up a little. Between the after edge of the elevator opening and frame 137 the deck is severely warped and the wood deck covering is practically burned off by the intense fires below. The port deck edge at frame 131 is up about 3 feet above normal in a peak which starts at about frame 128. The peak drops to approximately normal level at about frame 137. Between frame 137 and 138 the deck is torn from the port edge to within approximately 8 feet of the centerline.

The port after corner of the deck is missing. The boundaries of the missing corner are: the after edge of the deck, the port side of the deck, the tear between 137 and 138, and a line parallel to the centerline and approximately 18 feet from the deck edge. The transverse deck beam at frame 140 is bent up

SECRET

USS INDEPENDENCE (CVL22)

structure below and points toward the conclusion that the missing corner was ripped off by reflected blast. Pages 218 shows a section of the deck, just aft of the tear and inboard of the missing corner, bent up and standing about 10 feet above the deck.

Gallery Deck.

The starboard gallery deck walkways and gun positions were virtually untouched as far as the expansion joint aft except for an occasional bent rail stanchion. The bulwark of the gallery walkway on the port side is bent inboard slightly between frames 13 and 18. The bulwark plating is somewhat dished and the stiffeners are slightly crumpled just above the walkway due to bending of the bulwark. Between frames 18 and 24 the gallery structure is missing. The railings are bent in between frames 26 and 28 but the walkway appears otherwise sound. The director station tub, frames 26 to 29 is bent upwards at about a 45 degree angle but appears to be in good condition, the walkways between frames 29 and 39 is bent up and distorted. The gun tub frames 32 to 35 is missing. See page 230. The outboard section of the gun tub frames 39 to 42 is missing but the main portion appears to be undamaged. The gallery level structure between frames 42 to 61 is missing with the exception of two I-beams which project from the side of the gallery. The radio mast at frame 62 is bent over the flight deck and the walkway structure is bent up at angle of approximately 30° , see pages 73 - 76, 168, 170, 171, 172, 185 and 186.

The gallery level structure frames 63 1/2 to 84 1/2 is generally damaged on the port side, as follows: gun tub and walkway frames 66 - 71 is bent up at approximately a 45° angle, the outboard deck section and bulwark of the gun position of frame 71 - 74 is missing and the forward and after sections of this bulwark are blown sharply forward. See page 76. Page 77 shows that the gallery structure between frames 74 and 80 is missing and between frames 80 and 84 1/2 it is blown tight against the main structure. On the starboard side, the stacks and uptakes are generally demolished but the uptake support frames and walkways appear to be in a satisfactory condition. See pages 34, 35, 76 and 77. The gallery walkway on the starboard

SECRET

USS INDEPENDENCE (CVL22)

Page 58 of 280 Pages

port side, the walkway is folded flat against the main structure between frames 84 1/2 and 89. The 20mm gun tub at frame 90 is tilted up about 15 degrees but is in serviceable condition otherwise. The walkway aft of frame 98 is generally folded up, and the radio mast is bent across the deck in line with the blast and is about 3 feet above deck at the inboard end. The director tub at frame 98 is in good condition, and the walkway between frames 100 and 105 is usable although railings are bent and twisted. The radio mast at frame 100 is bent across the flight deck in line with blast and at an angle with the deck of 30°. The outboard deck sector and bulwark of the 40mm gun tub at frame 100 is missing and the forward and after bulwarks are laid forward slightly at the outboard edge. Aft of this tub the walkway is laid tight against the main structure to frame 111 1/2. An army gasoline truck apparently was not moved by the blast. See pages 35, 77, 78, 152 and 153 for views of these areas.

Along the starboard gallery walkway the 40mm gun in the tub between frames 115 - 118 has been misaligned by equipment sliding over the deck edge. Pages 37, 39, 151 and 152 are views of this tub after removal of the gun for inspection. Various parts of the .26 foot whaleboats from the boat stowage 10 feet below, are laying in the walkway at frame 123. Eight torpedo and bomb trucks are laying on the flight deck or walkway in the general area of frame 124. The gallery structure is in generally good condition. The walkway, port side, is laid tight against the main structure as far aft as frame 122. Aft of 122 the walkway is pushed down and the radio mast is pointing outboard at frame 125. Aft of 125 the gallery structure suffered the generally severe disruption characteristic of other structure in the port quarter. See pages 38 - 43, 81 - 86, and 231 - 237.

In the instances noted above where the outboard sector of a gun tub and its attached bulwark are missing, the failure is probably due to failure of the bolts in the connection to permanent structure.

Main Deck (stern to frame 18).

The deck is in good condition from the jack staff to frame 8.

SECRET

USS INDEPENDENCE (CVL22)

Page 59 of 280 Pages

erections are in good condition. While one of the service ships was alongside in the target area, she dished the starboard sheer strake heavily at frame 10 1/2, causing a longitudinal bulge at the deck edge between frames 12 and 13 from the shell to 6 feet inboard. The deck in this area is moderately washboarded. The port after corner of the hatch between frames 10 - 12, starboard of centerline, is ripped from the deck and lifted about 1" and the port side of the coaming is dished about 1".

Main deck (frame 144 to stern).

As shown on pages 84 - 86 and 576 - 577, the port side of the main deck, aft of bulkhead 144 and outboard of 10 feet to port of the centerline, suffered severe disruption. The deck plating tore transversely approximately 6 feet along bulkhead 144 and frame 146. Between these frames the connection between the main deck and the side plating has held and the deck edge lifted approximately 18 inches above its normal position. The rest of the deck on the port side, outboard of the bulwark of the gun sponson, has been pulled down to an angle of approximately 60° with the horizontal by the extreme dishing of the shell and transom. Panels of bulkhead 144 are severely dished. The side plating, port side is bulged and is dished on the starboard side. The deck plating on the starboard side is also locally buckled. The bulwark around the after gun sponson is severely distorted along the straight portion. One section of the port side is laid inboard approximately 75° while the starboard side bowed outboard several inches as shown on page 585. The deck of the sponson on the port side is depressed about 25° from the horizontal, outboard of a line about 3 1/2 feet from the centerline. The depression in the portside panel of the 40mm R.S. handling room, frames 148 - 150 on the centerline, shown on page 84 is approximately one foot deep. Page 582 shows the separation of the connection between this panel and the main deck for the full length of the panel. This photograph shows very clearly that the stiffeners as well as the plating pulled free. The after panel of this house is dished about 3" and is separated from the deck for approximately 18" inboard of the port corner. The starboard panel of the house is dished about 3" from reflection of the blast off the 20# shield shown on page 585.

SECRET

USS INDEPENDENCE (CVL22)

Page 60 of 280 Pages

is consistent with results on other target ships. The overhead, which forms the deck of the 40mm director station over, sagged 3'' forward of the after panel and drooped slightly aft of it. The H-beam columns at frame 148, port and starboard, which form the quarter point supports for the overhanging structure above 01 level are twisted and have pulled loose from the upper brackets. See pages 581 to 586, inclusive. Page 578 illustrates the deformation of the 01 level aft of bulkhead 144 and the distortion of the longitudinals. Pages 579, 580, and 583 - 586 show the rupturing, twisting and general misalignment of the structure aft of bulkhead 144 and above the main deck. The boat handling platform frames 123 - 129 hangar deck level, is undamaged on the starboard side but, as shown on page 83, the port platform is bent upwards at angle averaging about 30° with the horizontal. The davits and operating machinery, port side, are useless. Pages 135 - 142 depict the port platform, and adjacent structure.

(b) Usability of deck in damaged condition.

The flight deck is absolutely unusable as a carrier deck in its present condition. The forward section is repairable and is safe for all ordinary purposes. The two center sections are not repairable but are safe for walking. There is a possibility that some portions of these two sections would fall if the ship were taken to sea in heavy weather. The after section is not repairable and is not completely safe for walking.

The main deck forward of bulkhead 18 is perfectly usable, as is the starboard gallery walkway, boat handling platform and main deck aft of bulkhead 144. The port gallery walkway is usable aft of frame 18. Aft of frame 18 the gallery structure, boat handling platform and the main deck aft of bulkhead 144 are not usable or repairable.

(c) Condition of equipment and fittings.

1. The anchoring, towing and mooring fittings and equipment are intact and usable forward, and on the starboard side, only, aft.

SECRET

USS INDEPENDENCE (CVL22)

Page 61 of 280 Pages

the handling winch is jammed and broken due to deformation of the supporting platform. The port davits are twisted and bent, and the overhead structure which supports the falls is structurally weak from effects of the blast. All of the starboard boat handling gear appears to be intact although the boat was demolished. Parts of this boat are reposing on the gallery walkway over. The life rafts on the starboard side, which remain, are intact and are apparently usable. The three which remain are forward of frame 31. The four which are missing were installed at frames 36, 44, 90 and 92. Only one life raft was stowed on the port side. It remains at frame 44, hangar deck level, and appears to be unusable. It is partially free of its lashings.

3. Airplane handling gear. Both elevators were locked at the flight deck level before the test, but were blown overboard. The locks for the forward elevator are in the following condition: Forward starboard retracted, and apparently not sheared; After starboard appears to be in like condition; Forward port projects approximately 1" beyond face of lock but does not appear to be sheared or deformed; After port projects approximately 1/4" beyond face of lock and does not appear to be sheared. The port waterway around the elevator opening is torn in way of the girder rail and is folded clear. The starboard waterway is distinctly humped in way of the guide rail and both locks. The auxiliary parts of the locks, such as yokes and guide rods, show some distortion. The guide rods, center retaining rod and lock pad may have been distorted by movement of the ship under the blast load, or by the elevator in leaving the ship. The latter cause appears more probable and would also account for the purely local deformation of the waterway bar. There appears to be a distinct possibility that the elevators failed approximately along the centerline of the ship in the same fashion as Areas 2 and 3 of the flight deck and were then blown overboard. The pressure relief obtained by loss of the elevators would account, in part for the lack of flight deck peaking in Areas 1 and 4. The waterway bar around the after elevator is only slightly affected, the two port locks are projecting about 1", the after starboard locks projects approximately 2" and the pedestal of the forward starboard

SECRET

USS INDEPENDENCE (CVL22)

Page 32 of 280 Pages

cant it about 10° forward and 15° to starboard.

4. Barriers, arresting gear and catapults. The flight deck sheaves and barrier stanchions appear to be intact, but the wires are pulled because the oil shock absorbing gear, which was supported just below the flight deck, has fallen to the hangar deck. Parts of this equipment are visible on pages 255, 257, 259, 260 and 261.

The securing bolts failed due to the movement of the flight deck.

The two arresting gear units between frames 132 and 135 are in place but are scorched and somewhat warped from fire and movement of the deck. The catapult and catapult tracks forward of frame 40 appear to be in good condition but the machinery on the gallery deck is displaced, probably by shock. One of the starboard airflasks has moved about 1" to starboard due to failure of a strap. The port catapult has not been operated due to shifting of the motor by foundation spreading. The motor and tank foundation shifted about 6" to port, and there was considerable oil leakage. The gage board and control panel have also shifted to starboard.

F. Exterior Hull (Above w.l.).

(a) Condition of exterior hull plating and causes of damage.

There is little immediately apparent damage of great significance to the starboard shell between the bow and frame 120. Pages 30 to 38 and 46 to 48 cover this portion of the hull. Page 31 however, shows denting along the top of the sheer strake in the vicinity of frame 15. This area was damaged while in the target area by one of the assisting ships and so was an area at main deck level, frames 32 to 39. The ripples immediately below, which extend to the waterline at frame 14, may be due to working of the ship in service or to a slight whipping of the bow from the pressure wave. The occurrence at this location, which is one of the weaker spots in the ship's girder, suggests blast effect as the probable cause but evidence is somewhat too local to be satisfactorily conclusive. The mild, but definite, herringbone failure pattern in the

SECRET

USS INDEPENDENCE (CVL22)

Page 63 of 280 Pages

Some evidence of normal service washboarding is visible, just above the waterline in the region of frames 95 to 100, on page 36. Deformation which is attributable to the blast begins at frame 120 and continues to the stern. See pages 37 to 41, inclusive. Pages 49 and 50 show a muddled failure pattern between the main and second deck at frame 120 which develops into a clearly defined wrinkle just above the third deck at frame 124 and continues to the waterline at frame 127. Just below the third deck, a series of panel ripples begin at frame 124 and continue to frame 142. These patterns are visible on pages 36 - 44, and page 49. The above deformations are consistent results of an hypothesis that under the influence of the blast, the stern moved to starboard about a vertical axis approximately at frame 126 while tending to rotate clockwise simultaneously about a longitudinal axis. Additional evidence of this effect is furnished by diagonal wrinkling of bulkheads 119, 126 and 132 on the starboard side in the vicinity of the waterline. Page 44 supports this view by indicating faintly a reversal in direction of these waterline panel failures between frames 142 and the corner of the transom. The side plating above the main deck and aft of frame 132 is generally unfair from the fire which raged in this area. The side plating is ripped from low order detonations between 126 and 136. There is a rip at frame 144.

The port shell between the bow and frame 35 is essentially free from any effects of the burst. Page 130 shows some very light dishing of the side plating panels in the region of frame 30 and a shadow line formed by the protection, from the heat wave, furnished by part of the gallery walkway.

Between frames 30 and 40 there is no clearcut structural evidence of blast damage although there is irregular panel dishing.

The photograph on page 60, although taken from Test B which caused no discernable increase in structural damage, strikingly illustrates the progressive worsening of the hull depressions and the clear definition of the deck lines. Individual panel failures, above the third deck between frames 55 and 70, are well defined on

SECRET

USS INDEPENDENCE (CVL22)

Page 64 of 280 Pages

are shown, whereas the changing shape aft of frame 59 permits impingement by the wave. Forward of this frame, such damage as can be defined may be classed as secondary, i.e. due to movement of the ship from action of the burst, or loading of members by pressure on flight deck, but aft of frame 59 it is indisputably the result of direct pressure. The trace of blister longitudinal #7 (third deck level) appears between frames 58 and 59, and that of blister longitudinal #9 (second deck level) at frame 60. Longitudinal #7 is stove in approximately 3" between frames 59 and 61, and approximately 2" between frames 61 and 63. From an apparently normal condition at frame 59 the dishing of the side plating between these longitudinals increases to a depth of 10 inches at frame 71 between #7 and #9, and 8" between #9 and blister top (main deck). Dimensions, from normal, of these depressions are given on plate Nos. 39 and 40. Dishing of panels below the third deck becomes apparent at about frame 68. There is a fragment hole (13" x 13") in the blister plating between longitudinals #7 and #9 which opened compartment B-304-V. The fragment could not be found inside. Between the blister top and longitudinal #9 the maximum depression of 18" occurs at frame 95; between longitudinals #9 and #7, 19" at frame 89; and below the third deck, 6" between frame 89 and 100. This longitudinal three panel pattern changes abruptly at frame 106 to a four panel pattern because of a change in the location of blister longitudinals, and ceases abruptly at frame 112, where vertical panels begin. Pages 87 - 93, are elevations showing the condition of the plating; pages 98 - 104 are overhead views illustrating the run of the longitudinals and panels. On page 93, notice the shadow cast by the line at frame 104. Pages 112 and 113 show the blister side plating between frames 107 and 114. Frame 112 is just forward of the fire hose. There is a break in the welded seam of the upper blister strake. Aft of frame 112 the trace of the second deck longitudinals is discernible; pages 113 and 114 show the deep buckle in the blister plate just below this longitudinal and emphasize the hard spot at the juncture of the longitudinal and the floor at frame 116. The blister is very shallow here and little deformation occurred. The same construction was used at frame 114 but the floor, page 115, shows the end of the blister and indicates by the traces of the main, second and third decks that the shell in this area also is heavily dished.

SECRET

USS INDEPENDENCE (CVL22)

Page 65 of 200 Pages

trace of the third deck begins to rise. The depression below the third deck aft of frame 126 is about 2 feet deep and is shown more clearly on page 116 and 118. The photograph, on page 115, also shows the lift of the third deck, the fading out of the trace of the second deck, and the appearance at about frame 128 of the longitudinal below the third deck. There are several minor holes and tears in this region. A very severe tear about frame 129 below the third deck is probably the result of high local stresses at this point due to the extreme deformation of the shell. See page 118. At the same frame, there is a tear along the main deck with a small vertical tear running down from it. The second deck traces disappears due to the extraordinary deep inward bowing of the shell structure, which is out of normal by several feet. In view of the manner in which the shell below the third deck, forward of frame 126 and aft of frame 132, retained its shape, the depression between these frames is difficult to explain on any basis except the difference in stiffening. Forward of frame 126, stiffening is provided at every frame; between frames 126 and 132, 1st platform to 3rd deck, stiffeners are placed every frame and a half. There is no stiffening at frame 133. Above the third deck there is a stiffener at every frame. Below the third deck aft of frame 134 the shell is stiffened at each frame except 141 and 143. The photograph on page 96 shows this pattern very clearly. Had no stiffener been provided at frame 142, the pattern would have approximated that in evidence between frames 126 - 134.

The structural chaos from frame 130 to the stern is well illustrated on page 96. At frame 130, main deck, there is a horizontal tear, the end of which, on the frame line, appears to be the forward terminus of a sharp bend line which runs down and aft to the second deck at frame 140. The tear extends from frame 130 to bulkhead 132. Above the main deck, the blast sheared the side plating vertically along bulkhead 132 and aft along the main deck to bulkhead 138, and folded the plating inward and aft about bulkhead 138. The shell is ripped vertically between the main deck and the bend line. The main deck and shell above the bend line have been pushed down and thus overhang the shell below the bend line.

Aft of bulkhead 138 the appearance of the ship suggests that the structure above the third deck was pushed forward and to

SECRET

USS INDEPENDENCE (CVL22)

Page 66 of 280 Pages

the shell and main deck is broken and the shell is folded in, carrying the second deck with it, until it approaches within approximately 1 foot of the plane of the third deck. The main deck split transversely along bulkhead 144 and is folded down over the opening in the shell which has been formed by the violent action which took place below. The shell and third deck connection, frames 140 to 146, is torn just above the toe of the weld. The shell above the third deck, bulkhead 144 to the stern, has been heavily folded, and being still connected to the main deck, aft of bulkhead 146, has pulled it in and down in such manner that the deck overlaps the shell. The port corner of the transom is folded forward and to starboard around the hard line 10 feet to port of the centerline, produced by the longitudinal bulkhead between the second and third decks. This fold appears to extend between the main deck and bottom of the ship on the transom and is well pictured on pages 127 and 128. These photographs show, also, that the port corner of the transom is pulled up out of position. This severe pulling of the corner can be followed as far forward as frame 136. Pages 125 - 129 are detail views of this area and show the severe distortion and tearing of the shell. Pages 128 and 129 show parts of a bad tear of the transom, 3rd deck level. Part of this tear is concealed by the folding of the shell and transom. The stern gun sponson fairing plate is torn at the toe of the weld to the transom from about 2 feet to starboard of the centerline, across the centerline and well up the port side.

(b) Exterior hull fittings.

Here are but few instance of failures of exterior fittings. The vertical ladders on the port side aft of the island, made of formed sections of sheet metal, were badly mangled. These ladders are typical of those fitted elsewhere on this ship, and on others. Their failure appears to have been due to the blast, augmented perhaps by fragments or large pieces of equipment striking them. Several sets of ladder rungs, formed of solid bar, were welded to the hull before the test. Several of these rungs are missing from being knocked off by boats covering alongside, but more have been affected by the blast. Formed vertical ladders are vulnerable to such damage also

SECRET

USS INDEPENDENCE (CVL22)
Page 67 of 280 Pages

rungs be used. Screwed pipe fittings in the hangar sprinkling system pulled apart with out visibly stripping the threads. Inspection of the flanged pipe fittings show instances of separation. Failure in such systems occurred in the pipes due to failure of supporting structure. Boat booms and accomodation ladders all of which were secured as for sea, were carried away by the blast.

(c) Details of impairment of shear strake.

Such impairment consists of dents in the region of frame 15 on the starboard side, buckle at about frame 120 starboard, and tears, folds and buckles aft of frame 129 on the port side, and is more completely discussed in subhead (a) of Item F

(d) Condition of side armor externally fitted.

None.

G. Interior Compartments (above the water or armor deck, if fitted).

This item contains the discussion for the hangar space in addition to that covering the areas surrounded by waterline boundaries. Item G-1 covers interior compartments as such, and G-2 covers the hangar space.

Because of marked differences in structural features and the nature and degree of damage in compartments below the hangar space as compared with that in the areas forward and aft of this space, sub-items under G-1 are divided into three parts. The first, covers all compartments above the waterline and forward of transverse bulkhead 45; the second, compartments below the main deck between transverse bulkheads 45 and 126; and the third, those spaces aft of bulkhead 126.

G-1. Interior compartments (above waterline or armor decks).

(a) Damage to structure and causes.

SECRET

USS INDEPENDENCE (CVL22)

Page 68 of 280 Pages

not severe. As a result of the force of the blast on the port side, the outer bulkhead in the air engineers office, frames 36 to 39, is buckled inward about fifteen inches. In the air conditioning space aft of this, frames 42 to 45, the outer bulkhead is dished in about four inches and the deck bulged upward about six inches. The foundation for the air conditioning unit is distorted. The flight deck bent, frame 42, shows a bad buckle at the toe of the bracket, and the web of the transverse deck beam is wrinkled at a point about eighteen feet inboard of the port bent column. The downward component of the blast on this level accounted in major part for damage to the overhead. The scratch gauge at frame 42 on the centerline recorded $7/8$ inch relative movement between the flight and gallery decks. Transverse bulkhead 45 is bulged inward about fifteen inches as a result of the force of the blast which penetrated the hangar space and exerted force on the after face of the bulkhead. Photos pages 243 and 244 show damage to this bulkhead and to equipment mounted on the forward face of the bulkhead, in the C.I.C. room. Photos pages 265 and 268 show the deflection of the bulkhead as viewed from the hangar space.

On the forecastle deck the overhead, at bulkhead 29, appears to have approximately one inch permanent downward deflection at the centerline, and the port side of the 40 millimeter ammunition hoist at frame 29 was distorted slightly. At frame 35 the transverse bulkhead was bulged forward approximately one inch; and between frames 44 and 45 the decks showed slight wrinkling, due mainly to the forward deflection of divisional bulkhead 45 from air blast which entered the hangar space aft of the bulkhead. The bulged bulkhead is shown on photo page 245. The deck overhead is deflected downward slightly, buckling the starboard stanchion at frame 42 and slightly buckling the port stanchion at this frame. Due to the inward movement of the port shell under the impact of the blast, a bulged area approximately 3 inches deep, was observed between frames 29 and 32. Shell stringers in this panel were distorted at both ends. The deck adjacent to the bulged shell is buckled downward about $4 \frac{1}{2}$ inches. The inward bulging of the shell discussed above extends aft to frame 42. Between frames 32 and 35 the bulge was about $2 \frac{1}{2}$ inches; between frames 35 and 37, about

SECRET

USS INDEPENDENCE (CVL22)

Page 69 of 280 Pages

intersections with the shell frames.

Damage on the main deck forward of the hangar space, frame 45 to the bow, was much less severe than that on the levels above. Structure above the main deck served to shelter main deck compartments from the downward force of the blast. In the wardroom messroom between frames 29 and 32 the shell is bulged inward approximately 2 inches. The inward movement of the shell deformed longitudinalinals at the end connections, and buckled the flange of the longitudinal about one inch. The deck overhead in way of this damage is buckled downward 4 1/2" immediately inboard of the shell. The inward bulges along the port shell extend on aft as far as transverse bulkhead 45 in the following order. Between frames 32 and 35 the shell is bulged 3 inches; between frames 35 and 37, 1 1/2 inches; frame 37 to bulkhead 39, 1 inch; and between bulkheads 39 and 45 only slight bulging is indicated. Shell longitudinalinals in way of the bulged panels, in general, show distortion and strain particularly at points near the connection to the frames. Transverse bulkhead 39 shows a diagonal buckle, running from high outboard at the starboard shell to low inboard for approximately one third the breadth of the ship. The buckle was distinct but shallow as indicated by a general forward dish in the bulkhead of 1/2 inch. Apparently the downward movement of the structure above this space as a result of the force of the blast on the flight deck caused the compression buckle in the bulkhead. On the starboard side the shell panels are bulged inward to various degrees from frame 29 to transverse bulkhead 45. Between frames 29 and 32 the shell is bulged 3 inches; between 32 and 35, 6 inches; between 35 and 37, 3/4 inch; and between frames 37 and 39, 1 1/2 inches. Shell stringers in way of the bulged areas show bowing and deformation near the welded connections at the shell frames. This starboard shell damage is believed to have been inflicted by a tug or other service vessel after the test. Transverse bulkhead 45 shows a smooth bulge extending from port to starboard between the forecandle and main deck levels. The maximum bulge, about 5 inches near the centerline, is seen best from the opposite side of the bulkhead in the hangar space as shown on photos, pages 265 to 271.

Compartments on the second deck forward of the hangar space suffered relatively little damage from the downward

SECRET

USS INDEPENDENCE (CVL22)

Page 70 of 280 Pages

The starboard shell forward of bulkhead 32 is bulged inboard a maximum of 2 inches in the upper half of the panel. The shell longitudinal stringer at mid-height shows signs of strain. The two outboard main deck longitudinals overhead, exhibit cracked paint at the afterside of bulkhead 32. The paint on frame 31 is cracked at the connection to the overhead. The main deck, overhead, is buckled downward 3 inches just inboard of the port shell for a distance of 33 inches forward of bulkhead 35. The outboard deck longitudinal shows a 2 inch buckle 42 inches forward of bulkhead 35. The paint on shell frame 34 shows cracks at the main deck. There is no damage between bulkheads 35 and 39. Bulkhead 41 shows a 1/4 inch buckle 12 inches inboard of the port shell. This extends from the second deck to a 12 inch pipe passing through bulkhead 41, 12 inches below the main deck. Downward movement of the main deck is evidenced by the buckling of deck longitudinals just forward of bulkhead 45. Buckling is greatest at the centerline longitudinal, the flange of which shows a one inch offset. This is the outer fringe of the damage on the second deck in way of the forward elevator pit, the bottom of which is the main deck, which suffered severe downward deflection as a result of the blast wave which penetrated the hangar spaces. Damage to bulkhead 45 is shown graphically on plate number 29.

Forward of bulkhead 45 there is no structural damage on or below the third deck.

Below the main deck in way of the hangar, frames 45 to 126.

Interior compartment structure above the waterline in way of the hangar suffered considerably more damage than similar structures forward of the hangar. As a result of the blast action in the hangar, the hangar deck was pushed down generally between bulkheads 45 and 126 taking the main deck with it. This load was transmitted to the bulkheads and stanchions in compartments on the second deck with resultant distortion in these members, the degree of distortion depending primarily of the rigidity of the structure above and the support provided below.

SECRET

USS INDEPENDENCE (CVL22)

Page 71 of 280 Pages

wave in the hangar space caused the entire main decks in this area to be deflected downward, seriously damaging the supporting structure beneath. About one foot forward of frame 47, a welded butt, apparently at a joint in a flush patch or filler plate, failed. The failure extends from a point about 4 feet inboard of the port shell to another point 6 1/2 feet farther inboard. The 25 pound plate material, obviously had not been correctly prepared for welding, as the fracture showed no evidence of beveling of the plate edges prior to welding. The resultant incomplete penetration contributed to a major degree in the failure of the joint. This failure is best shown on photograph page 273, taken from within the hangar space. In way of this failure the outboard deck longitudinal is completely fractured at the welded butt joint. The second and third outboard longitudinals show strain at transverse beam 47. Transverse bulkhead 49 is badly buckled below the main deck longitudinals. The buckle, running parallel to and about 12 inches below the overhead is approximately 6" deep and about 12" wide. It starts at the second main deck longitudinal inboard of the port shell and extends athwartship to a 12" pipe passing through the bulkhead, 10 feet inboard of the starboard shell. There are six minor splits in bulkhead 49 in way of the buckle, ranging from 3 to 12 inches in length. The entire watertight door at the centerline and the bulkhead in way of the door were deflected forward pivoting about the bottom of the bulkhead. The door and immediately adjacent plate remained essentially straight and apparently tight. Light stiffeners on the after side of the bulkhead bent in way of the buckle, and in some cases the welds to the bulkhead failed. The second stiffener to starboard of centerline initiated a three way tear in the main deck by a punching action when the deck was depressed by the blast. The tear extends 18 inches forward. The latter is in the zone of weakness of a seam. See plate number 30 and photograph page 592. The heavy transverse beam at frame 53 is deflected smoothly beginning just inboard of the port outboard longitudinal. A 4 inch pipe stanchion to the transverse beam at frame 53, at the port quarter breadth, buckled at midheight and deflected 19 inches to port, as shown on photograph page 600. The cutout in the web of the main deck transverse beam at frame 53 on the port side contributed to the distortion of the member. Cutouts of this nature in members which were highly stressed during the tests, although restrengthened somewhat by doublers and stiffeners, have been

SECRET

USS INDEPENDENCE (CVL22)
Page 72 of 200 Pages

Plates 5 and 26, and photograph pages 596, 597 and 601 illustrate the depression of the overhead in the buckling of joiner bulkheads in the area between transverse structural bulkheads 49 and 57. Plate 31 shows a 6 inch downward deflection of the main deck, primarily along the center breadth of bulkhead 57. Between bulkheads 57 and 69 the number 1 and 2 boiler uptakes bulkheads effectively aided in the support of the main deck, with a result that only a slight amount of strain in structural members on the starboard side was observed. Since the greater part of the uptake bulkhead structure on this level is to starboard of the ship's centerline, structure on the port side showed considerable strain and deformation. An example of such damage is the main deck beam at the quarter breadth stanchion at frame 53 shown on photo page 602. Bulkhead 69 shows buckling principally on the port side where the overhead is down approximately 1 1/2 inches and the bulkhead is torn at the overhead. On the starboard side the bulkhead outboard of the door is wrinkled horizontally. In the area between bulkheads 69 and 79, the support of the longitudinal bulkheads on each side of the centerline materially contributed to the support of the main and hangar deck structure overhead, with a result that the downward deflection of the overhead on the starboard side is slight, while on the port side in way of the passage a major downward deflection of approximately 1 1/2 inches was observed. On photograph page 605 the deflection of the main deck beam at frame 72 just outboard of the port longitudinal bulkhead and the weakening effect of the cutouts in the web of the beam are clearly shown. Bulkhead 79 is buckled from port to starboard as a result of a 2 inch downward movement of the overhead at the port quarter breadth, the deflection gradually decreasing toward the centerline and starboard quarter breadth. There is a bad tear at the top of the bulkhead between the door and port shell. Boiler uptake bulkheads 3 and 4 so effectively contributed to the support of the overhead to starboard of centerline between bulkheads 79 and 91, that there is practically no damage to structure on this side of the ship. To port of centerline where there is considerably less support, the overhead is depressed approximately 2 1/2 inches at the quarter breadth point. Photograph page 607 shows a transverse beam at frame 88 on the port side, crippled just outboard of the uptake structural bulkhead. Note the weakening effect of the cutouts in the web of the beam for fore

SECRET

USS INDEPENDENCE (CVL22)

Page 73 of 280 Pages

above. This failure is due to the tremendous upward pull exerted on the stringer strake by the upward force of the blast pressure wave in the hangar against the flight deck above. This upward force was transmitted through flight deck bent 89 the footing of which is connected to the upper side of the stringer strake of which is connected to the upper side of the stringer strake, over web frame 89, by heavy welds. Photos pages 608, 609 and 610 show the failure in the web while pages 442 and 441, respectively, show the flight deck bent footing, the weld to the stringer strake and the failure of the weld joining the bent to the shear strake. The longitudinal bulkhead on the port side for a distance of one frame forward of frame bulkhead 91 was crushed downward approximately 2 inches. A view of the damage to the bulkhead from the after side is shown on photograph page 611. Bulkhead 91 is deeply wrinkled on the port side and the door is non tight. There is a horizontal wrinkle through the center portion of the bulkhead and a severe wrinkle inboard the starboard door, which remained tight. The overhead between transverse bulkheads 91 and 101 in way of the crew's galley was generally depressed, ranging from as much as 5 inches in areas near and slightly to port of centerline and midway between bulkheads 91 and 101. The fact that there is no support for the overhead, other than the shell and the deck structure itself, between 91 and 101, accounts for the deep and general depression of the overhead in this area, as illustrated by photograph pages 612 to 617, inclusive. Bulkhead 101 is buckled with maximum distortion occurring on the portside in way of the watertight door. The overhead here is depressed approximately 2 inches. See photograph pages 618 and 619. Aft of bulkhead 101, in the crew's berthing space, C-201-L, structural damage is much increased. In addition to the overhead being deflected downward, the port shell in this vicinity begins to show considerable evidence of strain and permanent deformation. Transverse bulkhead 101 is buckled forward one inch at the top, and aft one inch at the bottom, due to approximately one inch downward movement of the overhead. At frame 103 the main deck transverse beam to port of the centerline is severely buckled by the inward movement of the shell. See photo page 620. The centerline stanchion at frame 106 failed by buckling as shown on photos page 621 and 622. The transverse beam at this location is deflected downward approximately

SECRET

USS INDEPENDENCE (CVL22)

100 the centerline stanchion is severely buckled by a 9 inch downward deflection of the overhead. Quarter span stanchions, starboard and port, are buckled to a lesser degree by deflection of the overhead at these locations of 2 and 1 inches respectively. Plate 27 and photograph page 623 indicate the damage inflicted in this area. From frame 108 aft to frame 113 the downward deflection of the overhead gradually decreases until at the bulkhead 113 the deflection is 4 1/2 inches at the starboard quarter breadth, 4 inches at the centerline and approximately 3 1/2 inches at the port quarter breadth. See plate 32. The downward movement of the overhead resulting from the force of the trapped blast in the hangar space above, buckled bulkhead 113 severely at the second deck level as shown on photos page 626 and 627. Tears occur near the top just to port of center. The buckles shown are from 6 to 12 inches deep and run from low port to high starboard, probably indicating, in addition to the downward deflection of the overhead a slight starboard movement of the main deck with respect to the structure beneath. This movement becomes increasingly apparent as one progresses aft from C-201-L. Photo page 625 shows a crippled mid-height port shell longitudinal and other evidence of deformation such as cracked paint on the shell plating. The slight inward deflection of the port shell begins to be apparent in this area, and becomes more pronounced as one progresses aft. Between frames 113 and 119 the overhead is deflected downward approximately 2 1/2 to 3 inches with a maximum deflection in this space of approximately 10 inches occurring at bulkhead 119 on the port side. The inward deflection of the port shell is more apparent here than in C-201-L. Photo page 628 shows the downward deflection of the overhead at bulkhead 119 and clearly indicates the inward movement of the port shell and the starboard movement of the main decks, overhead, with respect to the structure beneath. The buckle in the photograph runs from low outboard to high inboard. Damage to the bulkhead 119 is shown schematically on plate 33. Deflection of the overhead at frame 115 in this area is shown on plate 25. Starting just forward of bulkhead 113 there is a compression wrinkle in the second deck caused by the inward movement of the shell. This wrinkle extends through compartment C-202-L and on aft of bulkhead 119. It is about four inches high at bulkhead 119. Structure on the second decks between frames 119 and 126

SECRET

USS INDEPENDENCE (CVL22)

Page 75 of 280 Pages

frame 122 of 12 inches at the starboard quarter breadth, 4 inches at the centerline, and 15 inches at the port quarter breadth. As shown on plate 28, port, starboard and centerline stanchions failed by buckling. The transverse beam at frames 122 fractured in an inferior arc weld at a butt joint in way of an intersecting deck longitudinal. See photos pages 629, 630, and 631. As a result of the further starboard displacement on the main deck with respect to the structure below, bulkhead 126 shows numerous diagonal buckles running in general from low port to high starboard. See photo pages 634. The wrinkle in the second deck on the port side continues on through this compartment, increasing perceptibly as it runs aft, as shown on photo page 633. The inward movement of the port shell in way of bulkhead 126 as indicated by the buckling of the bulkhead in way of the mid-height shell longitudinal is shown on photo page 635. Wrinkling of the bulkhead further inboard in way of the wrinkle in the second deck is shown at the lower left in the photograph.

On the third deck in way of the hangar space, between transverse bulkheads 45 and 126, the structural damage is much less severe than on the second deck. Between transverse bulkheads 45 and 49 there is no structural damage. Between bulkheads 49 and 57 the overhead has been deflected downward several inches with a result that the final permanent set after the "spring back" was approximately one inch. Photo page 655 shows the failure in a butt weld in starboard quarter span stanchion at frame 53 in compartment A-312-3L and cracked paint on the overhead indicating strain. Bulkhead 57 was slightly crushed by the permanent downward deflection of the overhead one inch on the port side and approximately 1/2 inch on the starboard side. Bulkhead 69 was very slightly crushed as indicated by slight buckling and cracked paint in areas adjacent to the shell and port and starboard doors. Between 69 and 79 structural bulkheads showed only a very slight amount of strain or buckling. Between bulkheads 79 and 91 the uptake bulkheads acted effectively in resisting the downward movement of the overhead. Some slight indications of second deck deflection are noted, however, in the form of cracked paint or faint buckles in structural bulkheads, such as shown

SECRET

USS INDEPENDENCE (CVL22)

Page 76 of 230 Pages

to a negligible degree on the starboard side. The shell frames on the port side between frames 91 and 101 appear to be slightly deformed indicating some inward movement of the shell. The overhead between frames 91 and 101 is depressed as indicated by the slight downward deflection of the overhead at bulkhead 91 and a somewhat increased amount of deflection at bulkhead 101. See photos page 657, 658 and 659. Bulkhead 101 is wrinkled vertically along the port shell, and buckled several inches deep along the bottom near the port side. Wrinkles run through the port door which is badly warped and non-tight. On the starboard side there is a wrinkle outboard the starboard door. Aft of frame 101, in compartment C-301-L, the overhead to port of centerline is deflected downward from one to two inches as indicated by the crippling of the transverse girder at frame 104. Photo page 660 shows the girder and the weakening effect of the cutouts affected to facilitate the arrangement of piping. Further evidence of second decks deflection, although only to a slight extent on the starboard side, is evidenced through the cracking of paint and slight distortion in the web of the transverse beam in way of the supporting quarter span stanchion. Port side web frames from 101 to 113 and mid-height shell longitudinalinals from 108 to 113 clearly reveal the inward deflection of the port shell resulting from the air blast. Photo page 662 shows only slight distortion in webs 104 and 106. Photos pages 663, 664, 665, and 667 show seriously buckled members. Photos pages 665 and 666 show the fracture of the welded connection between the web of frame 110 and the third deck. The maximum deflection of the shell between frame 110 and 113 is approximately 3 1/2 inches. Bulkhead 113 is buckled on the port side with the ridge of the buckle running from low starboard to high port, indicating in addition to the slight downward movement of the overhead in this area, that the second deck has moved slightly to starboard with respect to the structure below. Photos pages 668, 669, and 670, show the buckle in bulkhead 113. On the port side aft of bulkhead 113, in the fruit and vegetable locker C-307-2A, the beam at 116 has been bent downward and the shell frame bowed inboard. See photo page 671. The starboard movement of the second deck and port shell are clearly shown on photo page 672 in the buckling of the athwartship ventilation duct and transverse bulkhead 119. Compartment C-308-1A

SECRET

USS INDEPENDENCE (CVL22)

maximum of approximately 15 inches as shown on photo page 675 and 676. Note the failure of the mid-height shell longitudinal in a welded butt. Bulkhead 126 is buckled from the one inch downward deflection of the overhead and the starboard movement of the second deck as shown in photo pages 678 and 679. The port shell is severely bulged in way of the bulkhead.

Compartments aft of the hangar space (above waterline).

Aft of the hangar space, damage to structure in way of interior compartments above the waterline is devastating. The severe "punching" effect of the blast which focused on the port quarter, is plainly evident from bulkhead 126 aft. The thinner shell plating aft of 126 probably accounts to some degree for the greater apparent damage in this area, particularly that below the main deck. In addition to damage suffered from the direct effects of air blast from the explosion of the atomic bomb damage from secondary effects, such as fire and possible low order explosions of mines or warheads contributed materially in weakening and distorting structure in this part of the ship.

On the gallery level the transverse bulkheads of the portside compartments in the overhang, outside the main shell, were badly distorted by blast and ravaged by fire. See photos pages 230, 231, 232, 233 and 235. Damage in the crews shelter and athwart ship passage due to blast and fire are shown on photo page 234. The 40 millimeter ready service ammunition room C-0310-M forward of bulkhead 138 is demolished. See photograph page 237. Blast and fire badly damage bulkhead 138 on the gallery deck level. Photograph page 236 showing the portside of this bulkhead illustrates the damage to structure in this area. The flight deck survey shows the overhead on the gallery deck level to be deflected downward from 2 to 5 inches. From examination of the flight deck it appears that the overhead from frame 126 aft to the flight deck overhang is deflected downward from one to four inches. The port side of bulkhead 144 has been damaged by blast. The entire width of bulkhead 144 is damaged by fire, as are the com-

SECRET

USS INDEPENDENCE (CVL22)

Page 78 of 280 Pages

by fire, relatively little damage was sustained on this side of the ship as a result of air blast. Some slight bulging inboard was noted on the outboard bulkheads of compartments at this level.

On the poop deck structural damage resulting from the effects of fire was severe. Damage from air blast on the port side was extremely heavy. Compartments aft of bulkhead 126 and forward of bulkhead 132 are gutted by fires, which spread from the main deck compartments below. On the port side the shell in way of C-0201-EL is deflected inboard and torn. See photo page 247. The ravages of fire and blast are evident in the crews berthing space aft of bulkhead 132 as shown on photo page 246. Bulkheads in this area are badly distorted, the overhead is deflected and burned, and the port shell is torn open by the blast. Aft of bulkhead 138 in the crews berthing quarters the port side of the structure, including the port shell, has been demolished by the blast which penetrated the side of the ship at this location. Additional structural damage was done by fire which swept the area sometime after the blast wave struck. The torn shell and disrupted compartment described as shown on photo page 248. The tear in the shell is better shown in the photograph on page 249, looking out board through the side of the ship. The connection between bulkhead 138 and the deck failed in the welds, as shown on photo page 250.

Structural damage in way of main deck compartments aft of the hangar space is extremely heavy. Most of the devastation to the port side structure was the direct result of air blast. However, considerable damage to structure throughout the spaces aft of the hangar resulted from fire. Local damage to structure between frames 126 and 132 on the starboard side resulted from the low order explosion of the Mk. 24 mine or torpedo warheads which were apparently "cooked off" by the fire which is considered to have spread from the carpenter shop, on the port side. Photo page 567, 568 and 569 shows the damage to the starboard shell in the torpedo stowage space C-101-B. Note the tear in the thin shell plating at the sheer strake just above the deck, and the damage to the shell framing. Photo page 570 shows the damage to the

SECRET

USS INDEPENDENCE (CVL22)

photo page 571. The forward bulkhead which was deflected forward by the explosion is better shown in photographs taken from the hangar space, as illustrated on pages 563 to 566. In the shipfitters shop, on the port side, the bulkheads are blackened by the fire, which is believed to have originated in this compartment, and spread throughout that part of the ship aft of the hangar and above the main door. The deck is depressed in this space, particularly toward the after part of the compartment. This was caused in part by the turning down of the outboard edge of the main deck in this area as a result of the punching effect of the blast between the main and third decks. Bulkhead 132 is torn from the deck at the welded connection as shown on photo page 572. The port shell is bulged inward and torn from the force of the blast. Damage to the forward bulkhead is shown on pages 563 to 566. This compartment and the one immediately aft, C-106-E, aft have been completely gutted by fire. The latter, which is the shipfitter shop, was almost demolished by the combination of fire and blast, as shown on photo pages 573 and 574. The main deck on the port side was pulled down and at the outboard edge as in the compartment forward, but to a greater degree since it was nearer the point where the blast penetrated the shell below. The inboard bulkhead and stiffeners are deeply dished and badly burned. Photo page 574 shows air blast and fire damage to bulkhead 138 in this space. Similiar damage, but to a lesser degree, from blast and fire, is in evidence in the lighting repair shop, tool issue room and the oxygen tank stowage space between bulkheads 138 and 144. On the starboard side, aft of the torpedo stowage space, the stowage battery shop and the aviation armory are gutted by fire. The damage to blast in these spaces is small but deflection of the main deck, as a continuation of the damage done by the blast on the port side, is apparent. Aft of bulkhead 138 on the starboard side, the crews water closet, C-109-L, the decontamination space and the diving gear locker were swept by fire. Structural damage from blast was negligible, except for the continuation of damage inflicted to port side spaces through certain members such as bulkheads and decks into the starboard spaces. The welded connection joining bulkhead 144 to the main deck failed as a result of the force of the blast from aft. The overhead is blackened by fire and is slightly sagged.

SECRET

USS INDEPENDENCE (CVL22)

Page 80 of 280 Pages

stowage space, allowing embers or burning material to fall into the berthing space, igniting bedding and other flammable materials. The overhead on the port side and toward aft was deflected downward and scorched, the port shell was deflected inward, severely wrinkling the second deck, as shown on photograph page 637. The outboard edge of the main deck is turned downward as shown on the port profile, plate 1 and photos pages 85, 86 and 95. The deflection of the overhead on the port side in way of frame 129 is shown on photograph pages 638 and 639. Transverse bulkhead 132 is burned and badly buckled as shown on page 640 and on plate 35. The starboard shift of the main deck and the depression of the overhead account for the wrinkles shown in the bulkhead. The fire did not spread beyond C-204-L on this level. Aft of bulkhead 138, in compartment C-205-2L, port side damage to structure by air blast is considerably heavier than forward of 132. The port shell has been thrust violently inboard along the mid height stringer approximately 6 feet at frame 132 and 8 feet at bulkhead 138. See photos pages 641 and 636. The inward movement of the shell in this compartment wrinkled the outboard portion of the second deck badly and turned downward the outboard edge of the main deck. Bulkheads 132 and 138 have been crushed inboard on the port side and indicate from the direction of the wrinkles, which is from low port to high starboard, the lateral movement of the structure above; see plates 35 and 36. The overhead sags throughout the compartment, particularly from the centerline to port. Transverse beams overhead are badly buckled as a result of the inward movement of the shell. See page 644. The centerline longitudinal girder is crushed in way of bulkhead 138, as shown on photo page 643. Aft of 138 the blast penetrated the port side carrying away inboard the 10 and 12 pound medium steel shell plating; turned downward the outboard edge of the main deck overhead; wrinkled and depressed the second deck and buckled transverse beams and bulkheads. The above damage is shown on photos pages 646, 650, and 651. Starboard side structure is relatively undamaged as shown on photos pages 648 and 649. The port shell in this area has been deflected inboard about eleven feet or to the quarter breadth stanchion just forward of bulkhead 144, as shown on page 650. Aft of bulkhead 144 in C-207-L the port shell is badly deflected inboard and torn at the overhead

SECRET

USS INDEPENDENCE (CVL22)

Page 81 of 280 Pages

out outboard edge the main deck is torn and turned sharply downward. Bulkhead 147, similiar to 144 is buckled in such a manner to clearly indicate starboard movement of the structure above the second deck. See plates 37 and 38. In the C.P.O. wash room, water closet and showers between bulkhead 147 and the transom, considerable structural damage was sustained as a result of the lateral effect of the blast both from port and aft. The port side of the bulkhead was crushed inboard by the deflection of the port shell, and buckled downward by the depression of the overhead. The bulging of bulkhead 147 in C-208-L is shown on photo page 653. The transom plating was bulged inboard at this level.

On the third deck aft of the hangar space damage to structure on the port side, although heavy, was hardly as severe as that on the second deck. Aft of bulkhead 126 in the crews berthing space in C-309-L. The overhead to port of the centerline is deflected downward; the overhead structure is crushed inboard in deep wrinkles, as shown on photograph page 680; and the shell is bulged inboard at the overhead, crippling or breaking the frame connections to the third deck and buckling transverse beams in the overhead structure. Bulkhead 132 is crumpled in for several feet along the port side and through the port side door. A large buckle occurs inboard this door. The bulkhead on the starboard side is seriously buckled and the door is rendered non-tight. See plate 35. Aft of bulkhead 132 in compartment C-310-L damage is very similar to that in C-309-L, except somewhat heavier. The port shell is crushed in at the overhead, frames are broken at both the deck and overhead, and the second deck is down badly to port of centerline, particularly at the outboard edge. At bulkhead 138, as shown on plate 36, the overhead on the starboard side is depressed from one to four inches, while on the port side the overhead is deflected downward as much as twelve inches. The bulkhead is badly crushed and buckled as indicated. Between transverse bulkheads 138 and 144, in crews berthing space C-312-L, damage to structure was similar to, but heavier than, in C-309-L or C-310-L. The port overhead in this area suffered the maximum deflection observed for any similiar structure throughout the ship. Bulkhead 144 on the port

SECRET

USS INDEPENDENCE (CVL22)

Page 82 of 280 Pages

from the lateral force of the blast, the intercostal shell frames were broken away at the fillet welded connection to the third deck, and the 12 and 15 pound shell plating was ruptured at the deck along the fillet welded seam. Although welds connecting intercoastal shell frames to decks appeared small for the thickness of sections joined, it appears obvious from an examination of the area between frames 126 and 147 that intercostal design such as employed on the INDEPENDENCE in this area constitutes a structural weakness. In the crews library, C-313-L, and in the berthing space between bulkhead 147 and the transom, the damage although very similar to that in C-212-L, is somewhat less severe. The port side is crushed inboard several feet at the overhead, and the port shell and overhead framing are badly buckled, as in bulkhead 147; see plate 38. In this area the port after corner of the third deck is tilted up several inches as a result of the punching action of the blast on the shell plating between the main and third deck. Portside damage to bulkheads and wrinkles in the second deck overhead are shown on photo page 682.

(b) Damage to joiner bulkheads and causes.

Forward of the hangar space (bow to frame 45).

Metal joiner bulkheads were badly damaged in areas where the overhead was deflected downward by the blast or where the blast wave penetrated to the interior through doors which failed or through fractures in the shell plating.

On the gallery deck on the 03 level, blast entered the port shell through a door from the aviators ready room, just aft of bulkhead 39. See photo page 239. The blast was deflected just inboard the door by a steel partition serving as a light lock. The blast and pressure wave severely damaged the inboard metal joiner bulkhead to the C.I.C. room; the inboard joiner bulkhead of the aviators ready room at frame 42, and progressed forward down the port passageway to frame 37. Here the pressure wave wrecked the joiner inboard bulkhead in compartment 0310. Photos pages 240, 241, and 242, respectively, show this damage.

SECRET

USS INDEPENDENCE (CVL22)

Page 83 of 280 Pages

to the overhead where they were secured. On the forecastle deck blast from the port side entered the door in the shell just forward of transverse bulkhead 45. The action of the blast demolished the joiner bulkheads forward to and including bulkhead 42. See photo page 245. Forward of transverse structural bulkhead 39 there was only minor damage to joiner bulkheads. Such damage was due primarily to the slight downward deflection of the overhead.

On the main deck forward of the hangar space light joiner bulkheads from the starboard passageway were dished to starboard a maximum approximately 1 1/2 inches between frames 39 and 45.

On the second and third decks forward of the hangar space joiner bulkheads are undamaged.

Compartments below the main deck in way of the hangar space.

Damage to joiner bulkheads on the second deck in way of the hangar space is severe. Thin bulkheads just forward of bulkhead 45 along the passage way, A-211-L, were buckled slightly by the downward movement of the overhead. Aft of bulkhead 45 in way of the bad depression in the bottom of the forward elevator pit joiner bulkheads were severely damaged. Photos pages 593, 594, and 595 show damage to bulkheads of the repair party locker, frames 53 and 54. Other damaged areas in this vicinity where the deck structure overhead was down a maximum of 14 inches, are along the port and starboard passageways between bulkheads 49 and 57. Joiner bulkheads in this vicinity were seriously crushed, buckled and split. Photos pages 596, 597 and 601 illustrate the damage on the port and starboard passageways, respectively. Bulkheads on the portside of the vessel between structural bulkheads 57 and 69 showed only slight deformation from the downward deflection of the overhead. This area was protected effectively by the added support afforded the overhead by the uptake bulkheads in this part of the vessel.

SECRET

USS INDEPENDENCE (CVL22)

Page 84 of 280 Pages

that joiner bulkheads were largely protected. In B-203-L, between bulkheads 79 and 91, joiner bulkheads were only slightly distorted on the port side due to the added support afforded the overhead by the uptake bulkheads. In the crew's galley between bulkheads 91 and 101 metal joiner bulkheads were heavily damaged by the downward movement of the overhead. Inboard and outboard bulkheads along both the port and starboard passageways are crushed as shown in photo pages 612 to 616. No stanchions were provided in this area to help support the overhead structure, and as a result the deflection of the structure reached a maximum of from 5 to 6 inches. This action crushed, split and otherwise deformed joiner bulkheads until doors would not function and panels and connections were rendered practically useless. In crew's berthing space, C-201-L, joiner bulkheads bounding the crews water closet and urinals were buckled by the downward movement of the overhead and the inward deflection of the port shell. Bulkheads on the starboard side were only affected. Compartments C-202-L and C-203-L are berthing spaces extending from bulkhead 101 to bulkhead 126 and contain no joiner bulkheads.

On the third deck in way of the hangar space, damage to joiner bulkheads, as a result of deflection of the overhead, is limited to slight panel deformation in compartment A-312-1L. This compartment is in under the forward elevator pit the bottom of which was badly deflected by blast, and as a result deformed structure in the ship beneath it. Other damage to joiner bulkheads in way of the hangar space on this level between frames 45 and 126 is so slight as to be negligible. Uptake bulkheads or inboard longitudinal bulkheads so effectively aided the support of the overhead structure in the next three spaces aft of A-312-1L that the structure did not deflect sufficiently to buckle joiner bulkheads.

There are no other joiner bulkheads aft of this on the third deck except those in the refrigerator spaces between bulkheads 113 and frame 123. Although bulkheads on the port side in the fruit and vegetable locker C-307-2A and in the meat locker C-308-1A show considerable deformation from the inward movement of the port shell and downward deflection of the overhead the lining material

SECRET

USS INDEPENDENCE (CVL22)

Page 85 of 280 Pages

Joiner bulkheads extra spaces aft of the hangar space:

There are relatively few joiner bulkheads aft of the hangar space. However, most of these are either damaged by the fire which sweep all compartments above the main deck, or by the force of the blast on the port shell and hangar deck.

Bulkheads in the ready room, ready room office and in the aircraft ammunition stowage room on the gallery deck were scorched and distorted by fire. The downward movement of the flight deck overhead contributed to the deformation and buckling observed. Bulkheads in the carbon dioxide bottle stowage and in the emergency battle dressing station are burned and deformed by blast from astern and from above.

On the poop deck there are no joiner bulkheads.

On the main deck aft of the hangar space joiner bulkheads bounding the "SK" radar room are demolished by the force of the blast from the low order detonation of torpedoes in the adjoining space C-101-B.. In the aviation metal shop on the port side, joiner bulkheads were demolished by the force of the bomb blast which penetrated the port shell, and by fire which reduced everything flammable to ashes. In the shipfitter and sheet metal shop on the port side there are no joiner bulkheads, other than the centerline bulkhead. This bulkhead is demolished by the blast wave which penetrated the port shell. Bulkheads on the starboard side in the storage battery shop, the aviation armory and the garbage grinder room are either demolished or badly damaged by blast which destroyed the intervening centerline bulkhead, see photograph 574. Joiner bulkheads on the port side in the tool issue room, oxygen transfer and stowage shop and the lighting repair shop are demolished by the blast wave which pierced the port shell. The centerline bulkhead between transverse bulkheads 138 and 144 is also demolished. Bulkheads to starboard of the centerline, in the diving gear locker, crews water closet and in C-109-L are either demolished or badly damaged by the blast.

SECRET

USS INDEPENDENCE (CVL22)

Page 86 of 280 Pages

slightly damaged as a result of the downward movement of the overhead. See photograph page 642. There are no joiner bulkheads in the spaces aft of the transverse bulkheads 138.

On the third deck aft of the hangar space there are no joiner bulkheads, except those between transverse bulkheads 144 and 147. The one on the port side was severely damaged by the downward movement of the overhead and the inward deflection of the port shell.

(c) Details of damage to access closures and fittings.

Forward of the hangar:

On the gallery deck the door in the port shell between the aviators ready room and the walkway outboard was carried away inboard by the blast as shown on photograph page 239.

On the forecastle deck the door in the port shell at the athwartship passage, just forward of bulkhead 45, was blown inboard by the blast wave allowing the blast to enter the ship and demolish joiner bulkheads inside. The companionway between the gallery and forecastle deck level was distorted by the relative movement of the decks by the vertical component of the blast which acted on the flight deck and transmitted the force to lower decks through the intervening structure. The companionway between the forecastle and main deck was only slightly deformed.

Access closures and fittings on the main, second, and third decks in this area were undamaged.

Access closures and fittings below the main deck in way of the hangar:

Access closures in bulkheads below the main deck in way of the hangar suffered major damage which in many cases resulted in the loss of water tight integrity of such closures.

SECRET

USS INDEPENDENCE (CVL22)

Page 87 of 280 Pages

board doors these doors appear to both be watertight. In bulkhead 69 the port door appears to be tight and undamaged. However, the door on the starboard passageway is warped and no longer tight. All three doors in bulkhead 79 have been rendered non-tight by deformation of the bulkhead and doors as a result of the downward movement of the overhead structure. The port door in bulkhead 91 is buckled and no longer watertight. See photograph page 611. The starboard door is apparently tight and undamaged. The port door in bulkhead 101 is no longer watertight as a result of the deformation of the bulkhead and door frame, as shown on photos pages 618 and 619. Bulkhead 113 is so badly buckled in way of the port side door that it is no longer watertight. See photo page 113. Although the bulkhead shows considerably less deformation on the starboard side, the watertight integrity of the starboard door is questionable. At bulkhead 119 on the port side the door and bulkhead are badly buckled and no longer tight. The watertight integrity of the starboard door is questionable because of the buckling of the bulkhead at that location. The doors in bulkhead 126 port and starboard are no longer tight as a result of buckling of the bulkhead and doors. See photo page 634.

On the third deck in way of the hangar space damage to access closures and fittings is considerably less than on the second deck. No damage in this category was found between bulkhead 45 and frame 100, even though several bulkheads exhibited indications of slight local buckling due to the downward movement of the overhead. At frame 101 the transverse bulkhead and door on the port side are buckled and non-tight. See photos pages 657, 658, and 659. There is no access through bulkhead 113 on this level. At bulkhead 126, port and starboard, doors are buckled and non-tight as a result of buckling of the bulkhead. See photos pages 678 and 679.

Aft of the hangar space:

Access closures and fittings in this area were severely damaged.

On the gallery deck the port side door in the shell, opening into the athwartship passageway was blown inboard and demolished

SECRET

USS INDEPENDENCE (CVL22)

On the poop deck all access closures inboard were either damaged by the downward movement of the overhead or demolished by the blast which penetrated the port shell. The double doors in bulkhead 126 on the starboard side are blown inboard. The single door on the port side is intact as shown on photos pages 563, 564, 565 and 566.

(f) Damage in way of piping, cables, ventilation ducts, etc.

Forward of the hangar space the effects of piping, cable, and ventilation ducts on the performance of structure during the test are negligible.

In way of the hangar below the main deck there are numerous instances where transverse beams and frames are weakened by cutouts in the webs of such members, both for piping and ventilation ducts. Structure in way of electrical connections and cables where stuffing tubes are employed performed very satisfactorily. Typical illustration of the latter, on photos pages 586 and 611 shows the severe deformation of the bulkheads adjacent to cable stuffing tubes caused by the downward movement of the overhead. Note that the area pierced by the stuffing tubes shows less deformation than the areas adjacent to it. Ventilation ports in bulkheads in way of deck beams and longitudinals are sources of structural weakness as shown on photograph pages 588 and 592. As a result of the downward movement of the overhead under the force of the blast, the deck longitudinal crippled the ventilation port and destroyed its watertight integrity. Structural transverse bulkheads do not, as far as strength is concerned, appear to have been adversely affected by pipes which pierced them. However, the watertight integrity of such intersections, as a result of the test is questionable. See photograph pages 590 and 591. On the second deck at frame 53, on the port side, the transverse beam is deformed in way of a reinforced cutout for a ventilation duct. Although reinforced by a doubler, the cutout served to weaken the member. Heavier doublers might overcome such weaknesses. See photograph pages 598 and 599. As shown on photograph page 605 the transverse beam at frame 72 over the port passage is deflected downward just outboard of the inboard longitudinal bulkhead in way of cutouts for cables and a water pipe. These cutouts are considered to have caused the local deformation observed. At frame 88 on the port side the downward deflection of the overhead resulted in the crippling

SECRET

USS INDEPENDENCE (CVL22)

Page 89 of 280 Pages

tudinal bulkhead intersected by the beam had much to do with the failure being localized in the vicinity of the cutout, as shown on page 607. Bulkhead 91, port is buckled badly in way of a ventilation port. The port is no longer watertight and contributed to the weakness of the structure. See photograph page 612. The transverse beam on both sides of the centerline stanchion at frame 106 is badly deformed through cutouts, one of which is pierced by a small water pipe. See photograph page 622. Similar but less drastic deformation is shown at frame 108 on photograph page 623. The transverse beam at frame 122, port, failed through a cutout for the passage of electric cables, as shown on page 629. Note the extreme deflection of the flange.

On the third deck, in way of the hangar, the transverse beam at frame 104 is deflected downward with the deck structure and locally deformed in way of cutouts for steam pipes and water lines. See page 660.

Aft of the hangar space:

On the second deck, just forward of bulkhead 138, the centerline longitudinal girder is crushed in way of a cutout in the web for a transverse steam line. See photograph page 643. Above the main deck, damage to structure from the blast is so extensive that the effects of piping cables, ventilation ducts, etc. on structure could not be readily ascertained.

(g) Estimate of watertight subdivision, habitability, and utility of compartments.

The hull is no longer watertight on the second deck aft of bulkhead 57, on the third deck aft of bulkhead 91, and on the first platform aft of bulkhead 113. Lack of watertight integrity is the result of buckling of the bulkheads under the main and second decks. The bulkheads generally buckled first through access openings, leaving the enclosure warped and incapable of being made tight. Openings in bulkheads for vent ducts were easily vulnerable because of the vent ducts, being weaker than surrounding structure, tended to fail early and permit the bulkhead to leak. In several instances bulkheads have been torn at hard spots formed by the intersection of structural members.

SECRET

USS INDEPENDENCE (CVL22)

Page 90 of 280 Pages

all transverse tears. There is a large fore and aft tear in the main deck, frames 128 to 131. Below the first platform the ship is tight except for occasional compartments aft of frame 126. The port shell is generally open aft of bulkhead 132 above the third deck. The fragment hole at frame 68 has opened one of the blister compartments, B-304-V. Due to the list, several of the tears in the shell are lifted out of reach of the swell in the lagoon and the ship is not taking water. At sea, however, she would be subject to progressive flooding such as to require damage control measures. Damage to watertight subdivision on the second deck is shown on photograph pages 611, 618, 619, 628, 634, 635, 640, 646, 647, 650, 651, and 653. Damage to watertight subdivision on the third deck is shown on photograph pages 657, 659, 678, 679, 681.

Habitability and utility of compartments on and above the second deck aft of bulkhead 126 are nil as a result of blast and fire damage. On the third deck between bulkheads 126 and 138, habitability and utility are seriously impaired by blast. Compartments aft of 138 on this level are not habitable or usable due to blast damage. Habitability and utility of other interior compartments in the ship, excepting those in the hangar space, are either unaffected or only slightly impaired.

G. Hangar Space.

(a) Damage to structure and causes.

The hangar spaces is bounded by the sides of the ship, bulkheads 45 and 126, the hangar deck and the flight deck. Structurally, the flight deck is a landing field on "stilts" placed on the main deck between two watertight bulkheads, in the middle half-length of the ship. The region under the flight deck is protected from the weather by light, 10#, side paneling between all supporting columns except in way of the expansion joints where the lower sections of the paneling are #12 gage, 4.4#, with a section of #17 gage, 2.25# above. The hangar construction does not contribute to the watertight integrity of the ship nor does it add materially to the strength of the hull. The hangar was filled with planes before the test.

SECRET

USS INDEPENDENCE (CVL22)

Page 91 of 280 Pages

laid hard up against the starboard bents and are a part of the hodge-podge of airplanes, engines, pipe, vent ducts, cable, hose, and other mangled items which comprise the debris littering the starboard side of the hangar. The remaining port panels went overside as did about 25 per cent of the starboard panels. About 25 per cent of the starboard panels are hanging by shreds, and the remaining 50 per cent are distorted in varying degrees. In crossing the hangar space, the port panels not only assisted the pressure wave in pushing airplanes and other equipment to starboard but carried with it all vent ducts and vertical piping. Some remnants of the starboard panels show evidence of moving inboard, and some on the port side of moving outboard, as though actuated by a second pressure wave moving toward the blast center. Although some further pressure effect has apparently pushed bulkhead 126 forward, the interior of the hangar suggests that the blast wave focused in the hangar space and expanded in all directions. Bulkhead 45 is dished forward, the hangar deck is depressed and the flight deck is pushed up and ruptured along the centerline. Small sheet metal enclosures such as control stations, uptakes, and rectangular ventilation ducts collapsed by dishing of the panels; indicating that the pressure which affected them behaved as though it originated within the hangar. It is interesting to note that the sheet metal walkway for servicing hydraulic arresting gear equipment is not deformed. See pages 475 and 476. The platforms of the elevated control stations in the hangar are bent upwards similarly to some sections of the port gallery walkways. The magnitude of the disturbance within the hangar is indicated by the penetration of a radial engine into the intake between frames 77-80. See pages 385 and 387.

None of the port side roller curtains are operable. The curtain between frames 107-110 is in place but the mechanism is damaged and the guides are crushed. All other curtains are missing. The starboard curtain, frames 50-53, is operable, and the curtains, frames 107-110 and 118-121, require only minor repair. Most of the curtains, frames 47-50, is missing and that between 121-124 is lying in the elevator well.

SECRET

USS INDEPENDENCE (CVL22)

Page 92 of 280 Pages

53 on the centerline. The following table of depressions is inserted for easy reference:

Frame	12 feet to port	Centerline	12 feet to starboard
49	6 inches	6 inches	6 inches
53	6 inches	14 inches	6 inches
57	0	6 inches	0

(For complete contour details, see plate 4A)

The hangar deck, which extends from frame 57 to frame 115, is generally and severely depressed. This deck is four feet above the main deck and is supported by a series of longitudinal and transverse plat floors. The longitudinal floors are located approximately 7 and 17 feet from the centerline, port and starboard, with flat bar stiffeners located 12 feet each side of the centerline at every frame. There is no longitudinal on the centerline. The omission of a longitudinal here results in a 14 foot span and accounts for the severe depression the full length of the deck. The deck survey figures on plates 41 and 42 which apply to the hangar deck have been gathered into an approximate contour map of this deck in plate 4A and show that the maximum pressure effect within the hangar occurred between frames 89 and 98 on the centerline of the ship where the depression is 15 inches. The area most affected is between frames 83 and 104 over the entire width of the deck. Although there is dishing between the transverse floors, the most noticeable pattern is created by the longitudinals and is shown on pages 279, 280, 282, 285, 286, 287, and 289; see also plate 4A.

The number and severity of the depressions decrease rapidly forward of frame 80. The severity of the depressions decreases slightly going aft from frame 101. Pages 290 and 291 show small but very severe local depressions lying between frames 107 and 115. Those along the edge of the elevator well are probably the result of impact by heavy equipment which dropped from the overhead or which were carried by the blast from the flight deck.

SECRET

USS INDEPENDENCE (CVL22)

Page 93 of 280 Pages

on the port side. The port shell is crushed at the intersection of the hangar deck and the deck itself is torn athwartships in some instances. The following photographs show these damaged areas in detail; 362, 402, 407, 444, 457, 458, and 499. The after elevator well is generally depressed between supports which are also buckled.

The average depression along the centerline is approximately 8 inches. Between frames 86 and 101 the average depression of the longitudinals is:

22 P	6 inches	22 S	3 inches
17 P	4 inches	17 S	3 inches
12 P	8 inches	12 S	5 inches
7 P	7 inches	7 S	5 inches

(See also, plate 4A)

Pages 281-283 show the condition of the longitudinal and transverse floors in this region. Between frames 92 and 115, the average depression of the longitudinals is:

12 P	6 1/2 inches	12 S	7 inches
7 P	6 inches	7 S	6 inches

All the above figures are approximate but indicate generally that the effect of the blast in the hangar is very nearly symmetrical.

Bulkhead 45, shown on pages 265-271, is severely dished along its full width. Traces of the main, fore-castle, and gallery decks are clearly visible. The depth of dishing between main and fore-castle deck is about 4 inches, between fore-castle and gallery decks it is approximately 8 inches and attains the maximum of 15 inches between gallery and flight decks. The extremely heavy dishing between these two decks is the result of direct pressure on the bulkhead from within the hangar augmented by pressure on the flight deck along the edge of the elevator opening. Even in this highly stressed upper panel there were no failures in plating or connections.

SECRET

USS INDEPENDENCE (CVL22)

Page 94 of 280 Pages

relative location of the bulkhead where the failure of the riveted connection, shown on pages 274 and 275, occurs. The failure shown on page 273 occurs just forward of frame 47 in the weld of a make up seam in a soft patch. Page 276 shows local damage caused by the shock initiated displacement of the starboard set of elevator operating sheaves, frame 56. Pages 277 and 278 show the effect on the floor at frame 56 of pressure on the hangar deck.

The floor at frame 115, shown on page 292, is buckled by the blast and from pressure on the hangar deck. The photograph shows, also, the damage to the edge of the hangar deck caused by a water truck as it fell from the flight deck into the elevator pit.

Bulkhead 126 is bulged into the hangar space from the combined effects of the blast wave and the fire and of low order detonations of torpedoes stowed in the starboard compartment just aft of this bulkhead. The bulging is much more pronounced on the starboard side than it is to port and attains a depth of approximately a foot to starboard of the centerline. This bulkhead is shown on pages 563 to 566 and the torpedo stowage is shown on pages 567 to 571. The tears through the welded seam at the top of the lower strake of plating are approximately six feet long, and the vertical rip through a weld in the strake just above it and to port of the centerline is approximately 3 feet long. The crumpling of the stringer, at the hangar deck level, in the starboard after corner of the elevator well may be due to the starboard movement of the stern. It is in this general location that the deep wrinkle in the starboard shell occurs. This crumpling is shown on page 564. This photograph also shows a distinct wrinkle in the plating of the elevator pit, running diagonally from the starboard corner, which is the formation to be expected if the ships structure were being squeezed by rotation of the stern. The side paneling above the hangar deck between frames 124 and 126 is dished.

Within the hangar space, the flight deck is supported by six partial bents and twenty-one full bents. The partial bents occur at frames 47, 50, and 53 in way of the forward elevator opening and at frames 118, 121, and 124 in way of the after elevator

SECRET

USS INDEPENDENCE (CVL22)

Page 95 of 280 Pages

tudinal hatch girders.

A full bent consists of similar vertical columns, except at frames 56 and 115, where the columns are medium steel 36"x16 1/2"x230 lbs. I beams; and a horizontal girder which is an H.T.S. I-beam 36x10 1/2"x116 lbs. The vertical and horizontal members are tied together at the upper inboard corners with 30"x30" brackets cut from 36"x12"x150lbs. I-beams.

Fifteen of these full bents run through the hangar deck and are connected to the hull by heavy welds to the shell and to the main deck. The six full bents which are located in way of the expansion joints are known as "wobble bents" and are connected to the hangar deck by plates which are welded to the foot of the column and riveted to the hangar deck. Each "wobble bent" is backed up by a bracket, in line with it, fitted between the main and hangar decks. One such "wobble bent" is located just forward and one just aft of each expansion joint. Their brackets are 72"x30" cut from 36"x16 1/2"x230 lbs. I-beam.

The bents are spaced at twelve foot intervals and support a system of longitudinals made of 12"x4"x14 lbs., lightened, eye beams, spaced two and one-half feet apart.

The restriction of the blast in the hangar space apparently allowed a build-up of pressure greater than that applied externally to the flight deck. The framed bents, not being designed to withstand this type of loading, were distorted by the upward displacement of the flight deck. Through the area of maximum deflection of the flight deck, bents at frame 77 to 95 (with the exception of the "wobble bents" at frames 83 and 86) were not able to follow the upward displacement of the deck. Consequently, the longitudinals have pulled away from the girders, leaving them almost completely devoid of any longitudinal support.

The flight deck girders have been displaced upwards from a minimum of four to six inches in the extreme forward bent at frame 56 to a maximum of over 80 inches amidships. The girders, in moving upwards have tripped, their flanges have buckled in varying

SECRET

USS INDEPENDENCE (CVL22)

Page 96 of 280 Pages

failures occurring at one or more of five highly stressed points. These stress concentrations are located at the arc-welded center-line butt joint in the flight deck girder and in way of the girder and column arc-welded connections to the flange of the port and starboard brackets. (See plates 5 to 24.)

The ease with which the wobble plates were extruded over the rivets connecting the port columns of all six wobble bents to the hangar deck increased the loading of adjacent structure and allowed the failures in the "wobble bents" to follow a pattern somewhat different from that found in the other full bents. The port columns of the "wobble bents" are pivoted upwards about the base of the starboard columns and the starboard brackets, receiving the highest stresses, have usually failed (see plates 7 and 8; 14 and 15; 23 and 24).

In addition to the damage created by the pressure from within the hangar space, the loading applied normal to all port vertical surfaces that remained in place helped to rack the bents to starboard. The port columns are generally distorted and bowed forward in varying amounts. The athwartship displacements conform roughly in degree with the magnitude of the upward displacement of the flight deck, being a maximum of about 15 inches to starboard in way of the overhead at frame 92 and falling to zero in way of the forward and after elevators. Most of this racking load is absorbed in the collapse of the bents before it reached the starboard columns. A few of these columns show compressive stress patterns near the base and are bowed slightly to starboard, but most of them are intact, the failures in way of the bracket welded connections preventing the columns from working throughout their length to any extent.

All of the plane arresting gear motors secured to the overhead spaces between bents sheared through their hangar-clip bolts (thirty-six to each unit) and dropped to the hangar deck demolishing all equipment directly below them (see photos, pages 255, 257, and 260).

The two elevators were locked in the "up" position at the time of the test. They apparently lifted vertically and cleared

SECRET

USS INDEPENDENCE (CVL22)

Page 97 of 280 Pages

ing pins were sheared. All of these had been reported as being in place. Of the eight locks (one at each corner of each elevator), one is out the full two inches, three are out about an inch, one was out about 1/4 of an inch, and three were flush - on one of the latter, the pedestal was broken. These locks are activated mechanically by rods which run around the opening frame one to the other, and are fastened at intervals to the structure. Warping and buckling of some structure in way of these systems may have pulled the rods sufficiently, and at an early enough time, to retract the locks as noted above. Also, had the elevator buckled slightly, it could have cleared the locks. The damage to the port longitudinal hatch girder, frame 118, could have been caused by the elevator (see photo, page 262).

For purpose of detailed inspection, the hangar space is easily divided into four separate structures by considering the expansion joints as boundaries. These joints directly affect the reactions of the framed bents by denying those adjacent to the "wobble bents" the increased rigidity that would have been afforded by a continuous structure.

1. Section of hangar forward of first expansion joint.

Bents 47 to 62; see plates 5, 6, and 7, and photos pages 299-325: The section forward of the expansion joint at frame 63 1/2 contains two typical framed bents, a "wobble bent" adjacent to the expansion joint, and three partial bents in way of the forward elevator.

The partial bents are practically intact. The areas between these bents, frames 47 to 50 and 50 to 53, port and starboard, are used as loading accesses and are closed by roller-type metal curtains. The two after curtains were in an "up" position at the time of the test the two forward curtains were all the way down. Neither of the port curtains survived the blast, a foot or so of the after curtain is still attached to the overhead. A larger portion of the forward curtain remains (see photo, page 267). About half of the forward curtain on the starboard side remains. The after starboard curtain is still up and appears operable, its cover is damaged (see photo page 279).

SECRET

USS INDEPENDENCE (CVL22)

Page 98 of 280 Pages

The three full bents at frames 56 and 59 show the effect of the failure of the port wobble plate of bent 62. The port column of the "wobble bent" at frame 62 is displaced upward and aft about 45° (see photo page 89) allowing the port after corner of this section of the flight deck to pivot upwards about two feet. This action has resulted in the separating of the flight deck girders on bents 56 and 59 from their port columns in way of their bracket connections, (photos, pages 299-301). The girders themselves are deflected upwards in smooth curves, varying from a maximum of four inches along the centerline of bent 56, to 26 inches at bent 62. Girder 56 lies along the after edge of the forward elevator well and is substantially stable. The columns of bent 63 are heavier than usual and are tied into the main deck with the aid of a large outboard bracket. Girders 59 and 62 have tripped and their flanges are buckled (photos, pages 305, 315, and 316). Minor damage to the starboard portions of bents 59 and 62 are shown on pages 309 and 317 to 319. The remains of the air intake, starboard, and No. 1 uptake fill the spaces from frames 56 to 59 and 59 to 62 respectively (photo, page 310). The port panels from frame 56 to 65 are carried away (photo, page 253).

The expansion joint at frames 63 1/2 is separated about three or four inches, average, port to starboard. The after edge is pushed up about 15" further than the forward edge.

2. Section of hangar between first and second expansion joints.

Bents 65-83 (plates 8 to 14) - photos, pages 320-412: This section of the hangar, just forward of amidships, lies between the flight deck expansion joints at frames 63 1/2 and 84 1/2. The flight deck in this area is supported by five typical bents and bounded by "wobble bents" forward and aft.

The flight deck girders are pushed upwards about 57 inches, on an average, increasing from 54 1/2 inches at bent 65 to 70 1/2 inches at bent 83, and racked to starboard about 6 to 8 inches. Both port and starboard riveted pads connecting the "wobble bent" at frame 65 to the hangar deck have carried away and the base of the port column has pivoted upwards 21 inches (photos, pages 327, 328, 333, 334). The deck girder has failed about the centerline butt joint. The

SECRET

USS INDEPENDENCE (CVL22)

Page 99 of 280 Pages

Incipient failures appear in the port and starboard columns at their lower connections to the brackets (pages 329 and 332).

The flight deck is split open along the port edge of the centerline deck longitudinal (photo page 326). The port cover panel, frames 65 to 68, is missing. The remains of uptake No. 2 fills the starboard space (photo, page 335). The overhanging compartment above the uptake is typical of the damage to enclosed spaces in the hangar (photo, page 331). A general view of the condition of the hangar space between bents 65 and 68 is shown in the photo on page 257.

The full bents at frames 68 and 71 show the effect of shouldering the loads that were imposed upon them by the failure of the "wobble bents" at frame 65. Both girders are separated from the port and starboard column in way of the bracket (plates 9 and 10). The girders are tripped and the centerline butt joint of bent 71 has partially failed (photos, pages 344, 351, 355, and 357).

The failure in the port column of bent 68 appears to be attributable largely, to the action of the "wobble bent" immediately forward of frame 65. (Photos, pages 338-342.) The "herring-bone" pattern in the edge of the tear indicates that it probably initiated in both outboard and inboard flanges of the column along the forward edge and progressed aft. The web material in way of the separation appears laminated. The lower portion of this failure was cut out and sent to the Engineering Experiment Station at Annapolis, Maryland, for analysis. (Test No. C-2853.)

The condition of the port and starboard cover panels, frames 68 to 77 is shown in the photographs on pages 345, 349, 363, and 371 to 374.

Bents 74, 77, and 80 are distorted to an equivalent degree with bents 68 and 71. However, the damage in way of the bracket varies somewhat (see plates 11, 12, and 13). The girders at frames 74 and 77 are open from the top flange down through the web. The lower flange is intact. (see photos, pages 376 and 382.)

SECRET

USS INDEPENDENCE (CVL22)

Page 100 of 280 Pages

columns between frames 74 to 77 (photo, page 403). The overhead structure is completely destroyed (photos, pages 388, 401). Immediately above the port column at frame 80, the flight deck plating and wooden cover is opened up (photo, page 393). The starboard side between frames 77 and 83 is filled with the remains of an air intake and uptake No. 3 (photos, pages 385, 386, 400 and 419). Photographs on pages 387 and 389 show effect of blast on equipment in this area.

The base of the port columns of "wobble bents" 83 and 86 are now 36 inches above their original connections to the hangar deck. Both bents are torn open in way of their starboard brackets (plates 14 and 15). The photographs on pages 404 and 424 show the severe distortion in the port column typical of that observed for the "wobble bents" at frames 62, 83, and 110. The relative athwartship displacement between the structure forward and aft of the expansion joint at frame 84 1/2 can be seen in the photo on page 428.

3. Section of hangar aft of centerline expansion joint:

Bents 86 to 110; see plates 15 to 23; and photos, pages 415 to 545: The section of the hangar space immediately aft of amidships, bounded by the expansion joints at frames 84 1/2 and 111 1/2, contains seven full bents, spaced between "wobble bents" at frames 86 and 110. Considering deflection of the flight deck along the centerline as a measure of damage to the bents, the damage aft of the amidships expansion joint is greater than that in the section immediately forward. These permanent deflections average about 70 inches, running from a maximum of 81 1/2 at frame 86 to about 50 at frame 104, and tapering to 26" at frame 110. Comparatively, frame for frame, the girders in the after section are deflected upward on an average of about 20 inches further than those in the section immediately forward of amidships. The bents at frames 86 and 89 are approximately the center of maximum distortion. Forward and aft of this area the deflections of overhead and depression of the hangar deck gradually diminish with distance. Commensurate with the large centerline deflections the flight deck girders are severally tripped and distorted and the section is racked to starboard about

SECRET

USS INDEPENDENCE (CVL22)

Page 101 of 280 Pages

of the centerline butt failure of some of the girders (photo, page 498). The distortion in the port columns becomes greater in this section as does the condition of the port shell plating along the hangar deck level (see photo, page 444).

In following the flight deck upwards, the girders have induced high stress concentrations about their bracketed end connections which have resulted in failures in these areas on all but the starboard columns of bents 92 and 95. The girders themselves have failed about the centerline butt welded joint, with the exception of those at frames 89 and 107.

Immediately above the girder on frame 95, the flight deck and all of its longitudinal supports have failed from port to starboard in tension. The separations amount to two or three inches (see photos, pages 478, 479, and 482). Practically all of the port cover panels are missing. One mangled section remains in place at frames 95 to 98 (photo, page 260). The starboard cover panels in this area are partially destroyed but about 80 per cent have remained in place (photos, pages 435, 472).

All of the hangar space between frames 59 and 107 is painted white. This area is rather completely covered with caked dirt, even the overhead, but the paint is not scorched and does not show any effect due to heat. However, in way of frames 80 to 89, where the after fire room uptakes move outboard, the overhead structure is coated with heavy soot and grease (photos, pages 439, 450, and 453). The large area covered evidences a mild blast effect from the collapse of these uptakes. Planes parked nearby showed light panels dished and turned back under this attack.

All interior fittings, duct work, firing and piping in this section was completely destroyed. A general view is given in the photograph on page 261.

4. After section of hangar.

Bents 113 to 124; see plates 23-25 and photos, pages 546 to 563: The section aft of the expansion joint at frame

SECRET

USS INDEPENDENCE (CVL22)

the elevator well itself.

The base of the port columns of the "wobble bents" at frames 110 and 113 are about eleven inches off the hangar deck (see photo, page 532). The girders are pivoted about the top of the starboard column. There is no noticeable athwartships displacement (see plates 23 and 24).

The full bent at frame 115 is in good condition. The port column is bowed forward 4 to 5 inches, but there are no failures in the bent and the girder has not tripped. There is no apparent deflection at the centerline. The girder of this bent forms the athwartship elevator hatch girder and has heavier than usual columns, port and starboard, (36"x16 1/2"x230 lbs. I-beams tied into the ships hull at the main deck with a heavy 34"x117 1/2" outboard bracket). This is similar to bent 56 in way of the forward elevator.

The three sets of partial panels at frames 118, 121, and 124 flank the after elevator well. The port columns of these partial bents were the nearest to the center of the blast and the column at frame 118 is pushed inboard (a maximum near the upper bracket), the outer edge is tripped forward (photo, page 553). The starboard column is mildly distorted and the flanges are tripped slightly aft.

The port and starboard columns at frame 121 do not appear to be damaged. These columns were reinforced, to some extent, by the heavy channels used as backing for the port and starboard elevator guide strips (photos, pages 557 and 562). The columns at frame 124 were protected by the bulkhead at frame 126 and do not appear to be damaged.

The port elevator longitudinal hatch girder is torn in way of frame 118 (photo, page 262). This could have been accomplished by the elevator as it was blown overboard.

SECRET

USS INDEPENDENCE (CVL22)

Page 103 of 280 Pages

(a) Damage to armor deck and causes of damage.

There was no observable damage to the armor deck. This deck is the third deck between frames 49 and 106, and the first platform between frames 23 and 49; and 106 and 126.

(b) Complete protection was afforded to spaces below armor.

(c) Condition around openings.

Hatches were undamaged.

Gratings were undamaged.

Uptake bulkheads at this level were undamaged.

I. Interior Compartments (below waterline).

(a) Damage to structure and causes.

Apart from the holes in the shell caused by fragments and distortion of the third deck and shell from direct blast, there is no structural damage.

(b) Damage to joiner bulkheads and causes.

None observed.

(c) Details of damage to access closures and causes.

None observed.

(d) Condition of equipment within compartments.

The stores in the flooded spaces were partially spoiled.

SECRET

USS INDEPENDENCE (CVL22)

(c) A small amount of flooding occurred in compartments C-407-A, C-412-A, C-413-EA, C-415-A, and C-416-2A from the holes in the shell, the list of the ship prevented more water from entering. Shaft alley C-603-E flooded through the packing gland.

- (f) Damage in way of piping, cables, ventilation ducts, shafts, etc.

None, except as noted under sub-heading (e).

- (g) Estimate of reduction in watertight sub-division, habitability, and utility of spaces.

An estimate of 5% is ample.

J. Underwater Hull.

- (a) Interior inspection of underwater hull.

Interior inspection of underwater hull revealed no damage at or near the waterline on the port and starboard sides which was not reported under Item "F" (Exterior Hull). The extent of the deep wrinkle on the starboard side, frame 126, could not be determined because of the tanks below the first platform.

- (b) Effect of damage on buoyancy, operability, and maneuverability.

None.

- (c) Any known or suspected damage to:

1. Shafts and propellers - none.
2. Struts - none.
3. Rudder - none.
4. External keels - no damage.

SECRET

USS INDEPENDENCE (CVL22)

Page 105 of 280 Pages

None observed. Some damage may exist aft of frame 126 where inspection could not be made.

K. Tanks.

(a) Condition of tanks in areas of damage.

No observable damage to tanks.

(b) Contamination of liquids.

None discovered.

(c) Damage (known or suspected) to torpedo defense systems.

All structure in the port side, including the torpedo defense systems, aft of frame 55 is weakened by the overall damage reported under Item 'F'. Blister void, B-304-V, has a large fragment hole through the side plating several feet above the waterline.

L. Flooding.

The starboard shaft alley was partially flooded with a negligible amount of water seepage through the stern tube. No other flooding occurred.

	Forward	Aft	List
Before Test A, drafts	23' 0''	23' 6''	0°
After Test A, drafts	23' 0''	23' 6''	5° Stbd.

The ship took on an insignificant amount of water and listed 5° due to damage and shifting of the upper structure.

SECRET

USS INDEPENDENCE (CVL22)

Page 106 of 280 Pages

weather and the list of the ship which placed holes and tears in the shell out of reach of waves, is fortunate.

The watertight integrity in the after body of the ship above the first platform is negligible. The limits of floodable spaces are; below the first platform, all aft of bulkhead 144; on first platform, all aft of bulkhead 133; on third deck, all aft of bulkhead 81; on second deck, all aft of bulkhead 57; and all above the main deck, aft of the hangar space. In this large volume of the after body bulkheads are buckled and torn, doors and hatches are non-watertight and the port shell has several large openings along the third deck. The counter has tears in the plating. The starboard shell has a large hole above the main deck centered at frame 130. Ventilation ducts and piping ruptured.

If the ship had been at sea or in rough weather where pitching would have been induced, water would have entered through shell openings. With increased draft by the stern further flooding, which could easily have caused the loss of the ship, would have resulted.

After the crew returned to the ship, various bulkheads and holes in the shell were repaired to reduce the floodability. Bulkheads 101, 113, and 126 on the second deck were made tight. Bulkhead 126 had one door welded and a tear in the port shell welded, limiting flooding to aft of bulkhead 126. Bulkheads between the first platform and the third deck were made tight from forward to and including bulkhead 126. All shell openings on the port side were welded over to a level a few feet above the third deck.

M. Ventilation (exclusive of blowers).

(a) Damage to ventilation systems and causes.

Ducts: The ventilation ducts forward of bulkhead 45 are in excellent condition except for crumpling of two sections of duct in the fan room, port side, between frames 26 and 29. The fan room is located in the gallery overhang and was forced against the side of the ship by the blast, thereby crumpling the

SECRET

USS INDEPENDENCE (CVL22)

Ventilation intake and exhaust trunks located in the weather have been blown away by the blast. The trunks in the hangar space have been blown away or collapsed by the blast which entered the space after demolishing the port side plating. Page 573 shows the result of fire and blast action on a ventilation duct on the main deck at frame 134.

Between the main and second decks, the ventilation trunks, both intake and exhaust, show the greatest effect of blast carried down from the weather deck and the greatest effect from the collapse of supporting structure. Page 596 illustrates a crumpled duct at frame 57, port side. The ducts shown on page 604 and 606 burst from the blast pressure. Those pictured on pages 613 and 614 bulged so severely as to assume a nearly cylindrical form but did not fail. The seams of this duct were spot welded. As shown on page 622 there was a tendency for branch ducts of crimped construction to separate under severe structural deformation. The effect of bulkhead deck and shell deformation may be seen in pages 626, 628, 630, and 641. Pages 642 and 643 show failures in the CPO mess room. Fire and blast caused the failure of the ventilation systems at frame 144 shown in page 652.

The ventilation systems between the second and third decks forward of bulkhead 79 were, in general, unaffected. Trunks aft of frame 79 indicate bulging to a small extent. There were, however, no failures.

Closures appear to be effective where they are not damaged by buckling of the structure to which they are attached. In some instances ducts have separated from the closure.

While all ventilation was temporarily out of service, there would have been little change in the habitability of living spaces. Repair of some of the systems forward of bulkhead 126, by ship's crew, is feasible. Aft of 126 and above second deck, major effort will be required.

SECRET

USS INDEPENDENCE (CVL22)

Page 108 of 280 Pages

The bulging of ducts and the discharge of duct dirt from outlets indicates that blast was carried below decks. There is no evidence to show that heat, smoke, or fire were conducted by the systems. Except where the duct failed the effect was not serious.

(c) There is no evidence that ventilation systems allowed any flooding to occur. There is however, potential danger from this source in the open ends of systems on the hangar deck and in buckled closures in bulkheads below the main deck.

(d) Constructive criticism of design and construction of system.

Although there are ducts of riveted and crimped construction which held under pressure and deformation of supporting structure, the weight of evidence indicates that the most effective ducts are of cylindrical form and resistance welded construction: These should be fitted, using gate valve closures, where at all practicable.

N. Ship Control.

(a) Damage to ship control stations and causes.

The bridge and control steering station aft are usable. One pelorus stand in the open bridge, port side, is cracked off at the base. Although the disc steering wheel is bent away from its plane, it is usable. Several instruments are out of their mountings and some have been damaged by the blast or debris. However, the gyro and three repeaters function satisfactorily.

The C.I.C. is out of action because all radar antennae are gone. Some of the heavy equipment is damaged by shock. Extreme deformation of bulkhead 45 has damaged or displaced other items of equipment.

The gyro-compasses and all but one repeater are operative.

SECRET

USS INDEPENDENCE (CVL22)

is uninjured.

The telephone and loudspeaker systems either remained operable or were put into operation quickly after the crew reboarded the ship. It functions satisfactorily below decks and in certain spots in the "island" and hangar areas.

(b) Constructive criticism of ship control systems.

Satisfactory on this ship.

Most of the vital equipment was shielded from the blast to some degree by 15 or 20 pound structure. It is considered that complete shielding using not less than 15 pound plate, should be provided.

O. Fire Control.

(a) Damage to fire control stations and causes.

The only exposed fire control equipment aboard this ship is the Mark 57 director provided for each 40MM mount. The light metal sights of these directors have been damaged by the blast or flying debris, except for the forward starboard mount. All of the gun tubs were damaged or thrown out of position on the port side.

Except for spaces in the aftermost part of the ship, the plotting rooms protected by the hull suffered little damage. Fire control spaces are not usually located way aft.

(b) List of stations having insufficient protection and estimated effect on fighting efficiency of the loss of each.

All exposed stations are insufficiently protected. The effect on fighting efficiency would be the proportion of the number of stations damaged against the total number provided.

SECRET

USS INDEPENDENCE (CVL22)

Page 110 of 280 Pages

(c) Constructive criticism of location and arrangement of stations.

Unless personnel are to be considered expendable, complete protection must be provided for them. The universal loss of exposed fire control stations on this ship indicates that such stations should be an integral part of the ship's hull, or should be more securely anchored to it. Gun and director positions, which must be located along the ship's side should therefore, be completely covered sponsons with access passageways to them provided inside the hull. More such positions should be provided to compensate for the loss in effectiveness caused by covering the individual position.

P. Ammunition Behavior.

- (a) Ready service ammunition, location, protection, and behavior under heat and blast.

Main battery - not applicable.

Secondary battery - not applicable.

40MM, 20MM, etc. - There is no effect noticeable on the ready service ammunition aboard this ship. None of it was affected by heat. The stowages, where exposed to the blast were damaged, particularly along the port gallery walkway. Shelter and clipping room bulkheads were torn, distorted, and blown away, doors, scuttles, and fittings jammed. Under the condition prevailing on this test, the stowage provided in this ship cannot be classed as satisfactory. Spaces shielded from the blast are practically undamaged. The ready service house on the stern was in direct line of the blast and is severely dished, and buckled, see page 582. A similar structure in the forecastle protected from the blast offers no evidence of damage. Twelve torpedoes, with warheads, stowed in compartment C-101-B burned fiercely. This is not regular torpedo stowage and a fire of unknown origin caused the torpedoes to cook off. More protection than is offered by the construction of this compartment must be provided for warhead stowage.

SECRET

USS INDEPENDENCE (CVL22)

Page 111 of 280 Pages

Main battery - not applicable.

Secondary battery - not applicable.

40MM and 20MM - The magazines which were located deep in the ship show no effect of the test.

Bomb, mine, depth charge, and torpedo stowage - The blast had no effect on these types of explosives carried in normal reserve stowage.

- (c) List of stowages which are insufficiently protected and effects on ship survival of explosion of each space.

The stowages which were vulnerable were those exposed to direct action of the blast. This appears to be true because heat is not a factor and suggests that adequate screening is the primary requirement.

- (d) The gasoline stowage was very deep in the ship and because it suffered no damage, no data suggesting improvement was obtained.

Q. Ammunition Handling.

- (a) Condition and operability of ammunition handling devices.

Main battery hoists - not applicable.

Secondary battery hoists - not applicable.

Passing scuttles - not applicable.

Bomb and torpedo elevators - The bomb elevator is not damaged but is out of action due to lack of electrical power.

SECRET

USS INDEPENDENCE (CVL22)

Page 112 of 280 Pages

water.

There is no such evidence.

- (c) Constructive criticism of design and construction of ammunition handling devices.

Since there were no failures, suggestions on means of abviating them are not necessary.

R. Strength.

- (a) Permanent hog or sag.

Hull evidence: Plate 41 shows evidence of hangar deck depression along the centerline and the port and starboard deck edges. The change in configuration along the centerline must be eliminated as evidence of hog or sag because there is no support along the centerline, resulting in local depressions rather than an overall change in form of the ship structure. The port and starboard deck edges offer a better check because the structure is stiffer and is not so subject to local influences. Suspicion of the lines run before and after Test A shows little change between frames 45 and 65, and frames 101 and 126. Between frames 65 and 101, the hangar deck appears to have dropped varying amounts, with the port side affected more than the starboard. The maximum depression of 1 3/4" occurs both port and starboard of frame 80. The average port is approximately 1" and about 5/8" starboard. The port and starboard readings are most severe between frames 74 and 83, and taper off toward the end point; thus, supporting the conclusion that there is a slight sag. However the section showing the sag runs only for 1/3 the ships edges of elevator openings.

Bulkheads around door openings.

Blister and shell plating where framing was omitted.

SECRET

USS INDEPENDENCE (CVL22)

Page 113 of 280 Pages

- (1) The port side plating shell and blister plating.
 - (2) The port walkways.
 - (3) The hangar deck and elevator walls.
 - (4) Bulkheads 45 and 126.
 - (5) The transom and gun tubs aft.
- (f) Turrets, machinery and gear foundations.

There are no turrets on this ship.

Foundations for the operating gear of the port catapult is damaged. The airplane crane is off its roller path. Retaining bolts of the arresting gear hydraulic units failed.

The port side gear foundations are unusable because of damage to all overhanging structure.

S. Miscellaneous.

- (a) Evidence of heat damage variations under various colors of camouflage painting.

The location of scorched surfaces and direction of shadows cast by the head radiation indicate bearing of 220° from point of burst.

Red paint in Japanese flags on the "Island" has turned white from the effect of radiant heat. The zinc chromate yellow used for marking frame numbers are scorched black, except for a section at frame 25 where nearby equipment furnished protection.

The paint on the forward face of the "Island" frame 50, appears to be slightly blistered just at the inboard corner.

SECRET

USS INDEPENDENCE (CVL22)

scorched and there are blisters on the vertical pipes. The wood covering of the flight deck is scorched except where locally protected by test equipment.

Along the starboard side, the gallery walkway paint is unaffected by the heat radiation from the burst. The side plating and shell are unaffected except in way of the torpedo workshop, frames 126-132 above the main deck, where the torpedoes burned. Paint on the port side is scorched to a depth of one coat between the bow and approximately frame 20. Aft of frame 20, the scorching becomes increasingly deep, and, above the main deck aft of frame 126, there is considerable flaking of paint. There is no scorching of interior paints from radiation and none from fire except in way of the fire aft. This fire caused paint damage to both sides of bulkhead 126 and part of the after elevator well, above the second deck between bulkheads 126 and 132, and above the main deck between frames 132 and 144.

Examination of seven different navy paints discloses no blistering and only minor scorching. No differences are noted in the conditions of army or navy paints which were examined. An army fire engine truck, painted with Toluidine red is an alkid base, shows no scorching or blistering except where it came into direct contact with flame.

The paint on radar mast at frame 60, port side, is badly blistered and scorched by a local fire.

(b) Divers report.

On 16 July, a diving party furnished by T.U.1.2.7 made a thorough inspection of the underwater body of INDEPENDENCE, from frame 108 aft with the following results:

1. Rudder undamaged; rotated 2° left. (The rudder had been moved by the steering gear a few days previously.)
2. All struts, screws, and shafting appear normal except for one missing rope guard.

SECRET

USS INDEPENDENCE (CVL22)

4. From W.L. inboard for 7' on starboard side 126-130 very slight dishing.

5. Two holes at 108 port near W.L. and one at 110. These holes appear to be 3/4" diameter and are caused by pulling out of a plug weld made here near the end of the blister. The ship states these holes predated Able Day.

6. At frame 106 - Two minor dishes 25' from the port W.L. These were probably caused by previous service. The water was very clear, diving conditions were excellent, the divers spent about six hours on this assignment, and the information recorded is believed to be accurate and complete.

(c) Measurements.

The following measurements have been taken of structural deformation of the ship.

1. Flight deck survey.
2. Hangar deck survey.
3. Bulkhead 45 and 126 measurements.
4. Measurements third deck to second, and second to underside of main deck.
5. Flight deck vertical vent alignment.
6. Port side shell and blister deflection.

In addition detailed photographs have been taken of all flight deck beams, and the tops and bottoms (where failure occurred) of all vertical bents. Many photos were taken of the port shell. Photos were taken of the flight and hangar decks and of many regions of failure below decks.

SECRET

USS INDEPENDENCE (CVL22)

Page 116 of 280 Pages

W. Welding.

(a) General.

The effect of the test on this ship is of considerable importance because of the extensive use of welding in the original construction and her proximity to the blast center. While other units such as transports, submarines, and the ex-German cruiser PRINZ EUGEN have welded incorporated in their design to a greater degree, the INDEPENDENCE is the only combatant surface vessel of essentially welded design, in the target array, to suffer heavy damage.

The extent and gradation of the damage, from severe aft to negligible forward, affords opportunity to study, under diverse conditions, the performance of welds in different types of construction, and in various thicknesses and types of materials. Rough comparisons were obtained of the performance in similar structures, of seams joined by different methods of fabrication, such as welding, riveting, and crimping. In certain cases the more suitable method of fabrication for resistance to shock and blast is clearly indicated.

Because of the unique case provided by this vessel a careful study was made of the performance of welded connections throughout the ships structure. Details of damage in way of welded construction together with conclusions and recommendations based on observations made and correlated data derived from post test inspections, are included in the following report.

(b) Overall effect of the performance of welding on the vessel.

Concurrent with the general damage inflicted on the ship's hull, described in Item A of Part C, welded seams and connections were in many instances subjected to abnormal stresses,

SECRET

USS INDEPENDENCE (CVL22)

Page 117 of 280 Pages

The complete failure of numerous main structural elements at welded joints and connections, as in the case of flight deck bents and the shell and main deck structures, contributed in a considerable degree to the resultant inoperability of the vessel as a combatant unit.

Although riveted connections exposed to the blast are limited in number and structural significance, the inability of such connections to assume a proportionate share of the load was responsible to a marked degree for the failure of important adjacent structure, much of which was welded.

Detail description of such damage along with that related to structure or welded design are covered in the text which follows under the appropriate headings, according to location in the ship's structure and by pertinent photographs and sketches. Discussions under such headings deal with damage observed according to the structural element in which it occurs rather than by location according compartment, deck level or general area in the vessel.

(c) Island (superstructure).

Weld failures in this structure are not particularly significant and are limited to those joining bulwark stiffeners to the deck, and to fractures in seams in the bulkhead plating.

(d) Flight deck.

Arc welded seams and butts in the 5.1# medium steel flight decks, show no sign of failure although the decks plating was highly stressed and ruptured or torn in several places.

Intermittent fillet welds joining the flight deck plating to supporting longitudinal beams failed at frame 145 on the port side. See photograph, page 218. Failure occurred as a result of the tripping of the flanges of the longitudinal beams subjected the root of filled welds to high stress. A great weight to width ratio for these flanges would minimize the tendency for such failure. Similar failures occur in fillet welds joining the longitudinal deck

SECRET

USS INDEPENDENCE (CVL22)

Page 118 of 280 Pages

the deck beams was the major factor in the joint failures.

At frame 95, many of the flight deck longitudinal beams failed in the welded butt in way of the tear in the flight deck plating and directly over the transverse girder of the bent. See photograph pages 478, 479, and 482. Incomplete weld penetration contributed to the failures.

Flight deck longitudinal beams on the port side were fractured at the welded intersections with the after gallery deck bulkhead. These failures, are considered to have resulted, under blast conditions, from the local concentration of stress at such intersections, which are in effect, structural hard spots.

Examination of the expansion joints in that part of the flight deck which was bulged upward by the air blast, revealed failures in centerline butt welds in the deck transverse boundary channels. At frame 63 1/2 the channel on the after side of the expansion joint failed. At frame 84 1/2 the channels on both sides of the joint were fractured. While at frame 111 1/2, failure was limited to the channel sections at the centerline joint, and the resultant incomplete joint penetration materially contributed to the failures observed in these members. Photographs on pages 189, 190, 198, 187, and 206 show the damage described.

(e) Gallery deck, walkways and sponsons.

Except for some casualties to ventilation ducts and to joiner bulkheads, damage to connections at the gallery deck level is limited primarily to those failures in walkways and in gun and director sponsons on the port side of the ship.

Most of the weld failures were in thin medium steel plating and structure normally subjected to low operating stresses. Others were in austenitic chromium nickel steel welds in STS shields and bulwarks on gun and director sponsons. In both cases incomplete root penetration due to improper joint preparation and lack of back chipping is the predominate cause of weld

SECRET

USS INDEPENDENCE (CVL22)

Page 119 of 280 Pages

failures.

(f) Forecastle and poop decks.

There is no significant damage to welds in the forecastle or poop deck structures.

(g) Hangar space.

Hangar siding and side plating above the sheer strake: Much of the port siding in way of the hangar space was carried away by the blast. A study of the pattern of failure at the connections between this material and the framing structure did not signify any particular weakness due to welding. Several of the fractures indicated, instead, that failures are due, in effect, to the structural hard spots created by the intersection of thin members with thick members. Other fractures apparently followed welded seams in the thin side plating. Photograph, page 440, shows a fracture in the siding adjacent to a weld joining the siding to a flight deck bent. The weld joining the side plating to the poop deck on the port side failed as shown on photograph pages 144 and 247. Other tears along welds joining the side plating to the sheer strake at the main deck level and vertical tears at bulkhead 138 are shown on page 144. Photograph page 373 shows a distorted starboard side panel of welded construction in the hangar space. The stiffeners are attached to the plating by intermittent welds. No weld failures were found despite the deformation shown.

A web frame in the torpedo stowage compartment on the starboard side failed in the welded connection to the main deck, as shown on pages 568 and 569. Damage in this space was caused by fire and the explosion which occurred after the test.

Arc welded butts and seams in the 15 pound hangar deck plating showed no signs of failure although the deck plating was deeply dished between the supporting deep longitudinals. The all welded supporting structure was buckled in many locations but no weld failures occurred.

SECRET

USS INDEPENDENCE (CVL22)

Page 120 of 280 Pages

space, were in many cases, severely damaged by the blast as described under Item G. Much of the damage was at welded connections. The failure of these connections through the hangar space contributed, in a major degree, to the complete failure of the flight deck in way of the supporting bents. While the directions of loading and the extent to which loading occurred under the blast conditions imposed by the test were not fully reckoned with in the design of the flight structure, many of the failures were of such nature as to indicate inadequacy in the extent or quality of welding inspection, in the quality of workmanship of welding operators and in the design of connections, assuming severe shock or blast conditions. Of a total of 38 bracketed connections on the 19 bents in way of the hangar, 30 showed fractures, most of which were of a serious nature.

In many cases welds were definitely smaller than the size specified on the working plans. From the examination of fractured connections between brackets, transverse girders, and columns, it appears rather general that abutting members, contrary to plane requirements, have had no edge preparation prior to welding. As a result, such connections show incomplete joint penetration to a serious degree. This defect together with the fact that the size of fillet welds are under the requirements specified resulted in definitely weakening the flight deck structure. Photographs, pages 416, 417, 418, and 420 show the failure of the starboard overhead connection of flight deck bent 83 along the bracket and transverse girder. The builder plans calls for beveling the edge of the bracket web to permit 100 per cent penetration of the joint by weld metal. Actually, the members are joined only by fillet welds along the bracket web. These fillet welds, specified by the plane to be 5/16 inch in size, actually measured less than 1/4 inch in dimension. It is not surprising that failures occurred under such conditions, as the web sections joined by such welds were 9/16 inch and the flange sections 7/8 inch. Failures due to improper edge preparation and undersize welds accounted for more than half of the total failures found in the flight deck bent bracketed connections. Port side failures of overhead connections of this description are at bents 56, 59, 71, 92, 95, 98, 101, 104, and 107 and are shown on plates 5, 6, 10, 17, 18, 19, 20, 21, and 22, respectively. Starboard failures at bents 68, 71, 83, 101, 104, 107, and 110 are shown on plates 9, 10, 14, 20, 21, 22, and 23 respectively.

 SECRET

USS INDEPENDENCE (CVL22)

Page 121 of 280 Pages

overhead bracketed connections. Most of these failures propagated from fractures originating adjacent to welds, and may have resulted either from embrittlement of the base material in the weld heat affected zone or from local high stresses set up at the toes of the brackets as a result of the blast load imposed on the structure. Port side connections on bents 65, 74, 86, 89, and 98 are shown on plates 8, 11, 12, 15, 16, and 19, respectively.

Other instances of incomplete joint penetration are in evidence in welds at centerline butts in flight deck bent transverse girders. Nine out of a total of 19 such girders showed fractures. Fractures varied from those traversing only the top or bottom flange, to those completely fractured and separated.

There are indications that some of the members in the bent structure maybe of such chemical composition or in such metallurgical condition as to adversely affect the weldability of the material. This was evidenced by brittle fractures which appeared to have originated in the heat affected zones of welds. While relatively few shock failures occurred, they are considered sufficiently important to warrant an investigation of the materials involved. Accordingly, specimens were taken for metallurgical and chemical analysis. The results of this investigation will be reported under Engineering Experiment Station Test No. C-2853.

To facilitate study of the effects of design as associated with failures of the bracketed connections, plates 5 to 25 have been prepared. On these plates, the nature of the failure is shown diagrammatically along with notation as to the origins of fracture, where possible to ascertain. As access to many of the fractures was limited under the adverse circumstances prevailing during the period of inspection, it was difficult to accurately determine the origin and exact location of the fracture with respect to welds. Wherever possible close-up photographs and observations were made. In instances where fractures were not accessible for close examination, comments are based on a study of the area in question together with that of adjacent structure and on photographs taken from various angles and locations as close as possible to the damage. On such

SECRET

USS INDEPENDENCE (CVL22)

Page 122 of 280 Pages

tributing to failures are drawn from an analysis of this information along with design data shown on page 4. Welds joining the wobble bents to the riveted deck connection plates were fractured on the starboard side at frame 62 and on the port side at frame 65 and 110 as shown on photograph pages, 318, 328, 532, and 534. Limited significance is attached to these failures as the deck connection plates were permitted to deform sufficiently through failure of the riveted connection to place abnormal peaking stresses on the welded joints. Minor design changes in the connection would effectively minimize the possibilities of such failures.

Connections of the hangar bent columns and the STS shear strake on the port side at frames 89, 92, 98, and 107 failed apparently in the heat affected zone of the STS base metal adjacent to the austenitic chromium nickel steel welds. Photograph pages 441, 442, 456, 457, 487, and 521 show these failures.

Hangar deck: Arc welded butt and seam welds showed no signs of failure although the deck plating was heavily dished between members of the supporting structure. The welded supporting structure consisting of longitudinal and transverse floors between the hangar and second decks is buckled in many areas, but no weld failures were observed. Details of damage to the hangar deck structure are shown on photograph pages 279 to 291. A tear in a weld connecting the hangar deck plating to flight deck bent 74 and to the side plating on the port side was the only damage in way of welding in the hangar deck structure. Photograph pages 362, 363, and 364 show this minor damage.

(h) Main deck.

The permanent downward deflection of the main deck aft of frame 45, particularly in way of the elevator pits and aft of 125, as described under Item G, caused welded joints in certain members to be highly stressed.

A welded butt in the 17.5# main deck, one foot forward of frame 47 on the port side in way of the elevator pit is fractured. The fracture is approximately 6 1/2 feet long and shows

SECRET

USS INDEPENDENCE (CVL22)

the plate edge. See photograph page 278. In way of this failure the port outboard deck longitudinal is completely fractured at a welded butt joint.

At about frame 130, deck longitudinal number three failed and tore the weld joining it to the deck plating above, as shown on photograph page 639.

The transverse main deck beam at frame 122 failed in a welded butt at the intersection of the beam and port side deck longitudinal number three. See photograph pages 629, 630, and 631. The fracture originated in an inferior weld in the lower flange of the beam and extended on up through the web and collar plate covering the notch for the longitudinal. Examination of the fracture showed that the joint was poorly fitted and that a "dutchman" was used to avoid refitting. The section containing the fracture was cut out of the vessel and sent to the Engineering Experiment Station for examination to determine if materials were a factor in the failure and to what degree defective construction was responsible. Preliminary results are set forth above. Further results will be reported in Engineering Experiment Station Test No. C-2853.

(i) Second deck.

No significant weld failures were observed in the second deck structure forward of bulkhead 132. On the port side from frame 132 aft the second deck is severely buckled due to the inward displacement of the shell by the blast wave. As a result of the severe wrinkling and buckling which occurred, many of the welded connections between the deck beams, the shell frames and the deck plating failed. Since the structure in these areas is practically demolished no constructive criticism can be made of the design or quality of welding.

(j) Third deck and lower decks or platforms.

No significant weld failures were observed in deck or platform structures below the second deck.

SECRET

USS INDEPENDENCE (CVL22)

limited because of the difficulties of access to such spaces, no important weld failures were observed in these structures, port or starboard. A small fracture in the blister shell at frame 111 on the port side is shown on photograph page 113. This failure was in a weld at the after end of a plate in the upper strake of the blister shell plating.

(1) Shell - (below main deck).

Except in isolated cases there is no detectable damage to welds in the shell structure forward of frame 126. Aft of 126 the damage is considerable.

Failures in welds in shell plating (welded construction was employed in the fabrication of both butts and seams aft of frame 130) are best shown on photograph pages 119 to 129 inclusive. As a result of the marked inward deflection of the shell above the third deck several failures occurred. These were either in welded seams or adjacent to welds along the third deck line. Photographs pages 119, 126 and 128 show fractures along the line of the third deck, which is the deck shown to be intact about 6 feet above the water. A slight amount of undercut along the fillet weld joining the shell plating to the main deck probably contributed to the failure. The shell plating was also torn along a welded seam at the second deck level forward of bulkhead 144. See photograph pages 119 and 145. Failure also occurred along a weld joining the main deck and sheer strake aft of bulkhead 138, as shown on photograph page 120.

The welds joining the after sponson to the stern plating failed as shown on photographs pages 128 and 129. These photographs also show the failure in the weld joining the sponson plating and the STS gun bulwark.

Shell stringers and longitudinals.

On the poop deck level on the port side, at frame 140, the shell longitudinal failed in the weld joining it to the intersecting frame. See photograph page 250.

SECRET

USS INDEPENDENCE (CVL22)

A butt joint in the port side shell stringer at frame 124 1/2 on the second deck failed in the welds as shown on photographs pages 675 and 676. Incomplete joint penetration contributed materially to all weld failures in the above longitudinal members.

Frames.

Web frames 89 on the port side in fractured adjacent to the austenitic chromium-nickle steel weld joining the web to the STS stringer strake overhead. Failure occurred as a result of the strong upward pull exerted by the flight deck bent which was welded to the main deck stringer strake directly over this web. The fracture appears to be in the web material rather than in the weld. Photograph pages 608, 609 and 610 show the failure in the web below the main deck, while photograph page 442 shows the connection between the flight deck bent and the stringer and shear strakes. The failure of the shear strake connection, shown on photograph page 441, resulted in the transfer of added stress to the joint between the stringer strake and web frame below.

On the second deck, port side, the weld joining intercostal frame 137 to the shell stringer is broken. At web frame 138, the welds joining the upper end of the frame to the shell are fractured. Welds too small to develop 100% joint efficiency contributed to both of these failures. See photograph page 636.

On the third deck, port side, the welds joining web frame 110 to the deck failed as a result of the inward displacement of the shell. Undersize welds contributed to the failure. See photograph pages 664, 665 and 666. In the ice machinery room, port side, a similar failure occurred in the welds joining intercostal shell frames 124 and 125 to the mid-height shell stringer as shown on photograph page 676.

Other failures of intercostal frames at welded connections are shown on photograph pages 119, and 122. These failures are at the

SECRET

USS INDEPENDENCE (CVL22)

in the failures of T-joint connections of intercostal members.

(m) Bulkheads.

1. Structural bulkheads.

The divisional bulkhead just aft of the after elevator pit at frame 126 failed in a welded horizontal seam on the starboard side in way of the torpedo storage spaces as shown on photograph pages 564 and 565.

Bulkhead bounding welds failed along the deck in the shipfitters shop at frame 138 on the port side. These welds were undersize. The failure is shown at the lower right in the photograph page 574. Similar weld failures were observed on the poop deck level at bulkhead 138, and are shown on photograph, page 250. Bounding welds on the port side between the main deck and bulkhead 144 also failed. See photograph page 574.

In all of the above cases welds were too small to develop the maximum obtainable joint efficiency.

In the 40MM handling room at frame 149 on the main deck, austenitic welds joining the STS port and after bulkheads to the deck failed.

(n) Stanchions.

Welds connecting stanchions to decks or overhead structure failed in areas where overhead structure was deflected either upward or downward by the blast.

Failure where upward deflection occurred are located on the main deck, port and starboard, at frame 148 as shown on photograph pages 581, 584, 585 and 586.

On the second decks, port side, at frame 52 welds connecting the stanchions to the decks and overhead failed. See photograph page 600.

SECRET

USS INDEPENDENCE (CVL22)

On the third deck starboard, a butt joint approximately 6" below the overhead stanchion at frame 53 failed on the weld. The fracture revealed that weld penetration into the joint was very shallow. When the decks structure sprang back from its position of downward deflection, the stanchion which had been permanently buckled in compression failed at the weld instead of following the deck. See photograph page 655.

Although larger welds would prevent fracture at deck and overhead connections, all stanchions had apparently failed structurally by buckling before weld failures occurred.

(o) Uptakes.

Sheet metal uptakes on the hangar decks level are either badly crushed or demolished by the air blast. The outer jacket was of bolted and welded construction while most of the inner construction was welded. A number of corner joints failed as a result of insufficient joint penetration, or from welding from only one side. The general condition of the uptake structures after Test A are shown on photograph pages 310, 335, and 439.

(p) Ventilation.

Welded ventilation ducts and pipes on and above the second decks level suffered severe damage through being crushed or deformed by the movement of the overhead or adjacent structure, and from air blast which penetrated the ventilation system through outboard ports.

Most of the lighter ducts were of riveted or bolted construction and performed poorly under the conditions of Test A. Photograph pages 236, 246, 248, 330, 592, 652, show damage in way of such construction.

In general, arc welded ventilation ducts and trunks performed better than riveted and crimped ducts. However penetration of the blast into ventilation systems revealed the inherent weakness of corner joints welded from only one side.

SECRET

USS INDEPENDENCE (CVL22)

On the second deck at frame 95 on the outboard side of the port passageway, vertical duct showed pronounced evidence of internal pressure as a result of the blast wave being conducted below deck by the ventilation system. The duct, originally of approximately square cross section, was bulged and the walls distended until at certain locations it was almost circular in cross sections. See photograph pages 613 and 614. None of the joints failed as a result of the blast. The reason that failure did not occur appears to be in the superiority of resistance spotwelded joints over joints arc welded from only one side. Although this was the only resistance welded duct exposed to severe blast, the superiority in performance of ducts fabricated in this manner over those fabricated by riveting, arc welding, or bolting is clearly illustrated.

(q) Boat handling structure.

Several failures were observed in welded T-joints in the boat crane structure on the boat handling platform, port side at frame 125. The relative weakness of these joints as compared with the rest of the structure is due to small weld size and minimum joint preparation. Photograph pages 138 and 140 show the nature of the failures.

(r) Conclusions.

In general, the performance of welded construction on the INDEPENDENCE was very satisfactory. A few weld failures were found which were obviously the result of poor workmanship on the part of the welding operator. However, in most cases the primary causes of failure were lack of edge preparation of joints prior to welding; lack of, or improper back chipping on butt joints; improper fitting prior to welding and undersize welds. Failures of welds in important strength members in the flight deck structure resulted apparently, from failure to follow the joint designs specified on the plans. Flight deck bent connections showed many such deficiencies particularly at the bracketed overhead joints and at the centerline

SECRET

USS INDEPENDENCE (CVL22)

bent structure called for 100 per cent joint efficiency to facilitate in obtaining complete weld penetration. These design requirements were not met, as the photographs taken of failures in such joints will show. Deficiencies such as noted above are largely the result of failure to adequately inspect joint preparation prior to welding.

In view of the foregoing it appears that more adequate inspection of welding is needed, particularly inspection of joint preparation prior to welding. Where operating loads are high or in structures where important members are subject to blast, consideration should be given to fairing such members to a greater degree in way of connections.

SECRET

USS INDEPENDENCE (CVL22)

Page 130 of 280 Pages

SECTION II - MACHINERY

GENERAL SUMMARY OF MACHINERY DAMAGE

I. Target Condition After Test.

- (a) Drafts after test; list; general areas of flooding, sources.

No data taken by Machinery Group.

- (b) Structural damage.

The stacks were badly crushed and distorted at their bases and lower parts where they extend beyond the side of the ship at the hangar deck level. The upper portion of stacks #1, #3, and 4 carried away. Severe distortion of the hull near the stern is believed to have caused misalignment of the main shafting. Both airplane elevator platforms were blown overboard, pulling apart the wire rope cables. The guide rails on the port side of the after elevator were bent. The airplane crane was badly damaged structurally and is leaning outboard at an angle of about 15°. A great deal of damage was done to piping, especially in the hangar and on the flight deck, by failure or deflection of supporting structures. The port boat winch was blown overboard.

- (c) Other damage.

No damage to the main propulsion plant or its auxiliaries was found by visual inspections and operational tests, the main engines being turned at propeller speeds of 20 RPM. However, this is not a conclusive test of the main shafting, which is believed to be out of alignment. All boilers were made inoperable by damage to stacks and uptakes, which completely sealed the gas passages. There was severe damage to piping in the hangar and on the flight deck aft of frame 50, and slight damage to piping (especially refrigeration piping) elsewhere. Wire rope cable, which broke when the elevator platforms carried away, is badly entangled in the elevator machinery. The airplane crane, in addition to being damaged structurally, sustained

SECRET

USS INDEPENDENCE (CVL22)

Page 131 of 280 Pages

probably beyond repair. Ventilating fans in the hangar were demolished. The starboard boat winch, after casualty power generator diesel engine, and equipment in the carpenters', shipfitters', and torpedo workshops were burned out by the fires and explosions in the after areas of the ship and are beyond rep air.

II. Forces Evidenced and Effects Noted.

(a) Heat.

Screwed union joints at gage line valves of gasoline filling stations #1, 3 and 6 pulled apart. Apparently the nuts were expanded by heat of the secondary fire that raged in this area. These stations are at the outer edge of the flight deck. Other evidences of extreme heat topside are blistered paint and charred wood, canvas, leather, etc..

(b) Fires and explosions.

Fires and secondary explosions occurred in the hangar, on the flight deck aft of frame 50, and in the upper decks near the stern. These burned out the diesel engine of the after casualty power generator, the starboard boat winch, and equipment in the carpenters', shipfitters', and torpedo workshops.

(c) Shock.

There was no damage to machinery that could be specifically attributed to shock.

(d) Pressure.

The blast pressure of the explosion caused the major damage to the stacks, airplane elevators, crane, and some of the damage to piping. This pressure caused failures and deflection of decks and bulkheads which in turn, caused most of the damage to piping. The pressure wave appeared to have come from the port quarter.

SECRET

USS INDEPENDENCE (CVL22)

Page 132 of 280 Pages

The very high magnitude of blast pressure is apparently peculiar to the atom bomb.

III. Effects of Damage.

(a) Effect on machinery and ship control.

The ship was left without steam power and hence was immobilized. Temporary repairs to enable the ship to steam at slow speed would require at least 4 days. Damage to gasoline piping would have greatly accentuated the effect of fires and explosions if the ship had been operating under war conditions. Damage to gasoline, firemain, and water curtain piping would have handicapped efforts to fight the fires. The firemain in the hangar and on and above the flight deck level aft of frame 50 was inoperable except for a few connections on the port side. The airplane elevators were left useless as their platforms were blown overboard. The crane is inoperable. The hoisting gear of the crane could have been made operable for emergency use by a tender within about 24 hours, but the rotating gear is probably beyond repair. The port boat winch is missing. The starboard boat winch, the diesel engine of the after casualty power generator, and the equipment of the carpenters', shipfitters', and torpedo workshops are beyond repair. The refrigerating plant is inoperable but could be made operable by the ship's force within 2 days. The main shafts were believed to be out of alignment making high speed impossible even if boiler power for same were available.

The test had little effect on ship control from a machinery point of view, except to limit power available to that furnished by the two emergency diesel generators and the forward casualty power generator.

(b) Effect on gunnery and fire control.

No comment.

(c) Effect on water-tight integrity and stability.

No comment.

SECRET

USS INDEPENDENCE (CVL22)

Page 133 of 280 Pages

(d) Effect on personnel and habitability:
It is estimated that there would have been no casualties to engineering personnel below decks. Casualties would have been very high among exposed personnel. Habitability was reduced by lack of steam power and general damage to the area exposed to blast pressure and fires.

(e) Total effect on fighting efficiency.

The effectiveness of this vessel as an aircraft carrier was reduced to zero, and could not be restored without a major overhaul.

IV. General Summary.

It would appear that no aircraft carrier now afloat could withstand an attack of this nature at such close range without serious reduction of her military effectiveness as a carrier. Extensive studies of design features of this type are indicated.

V. Preliminary Recommendation.

Recommendations based on the experience of this vessel are too numerous for all to be listed here. A few of the most important will be mentioned in a general way.

1. Redesign stacks to enable them to better withstand blast pressure, and relocate them so all will not be badly damaged by blast pressure coming from one direction.
2. Study the design and layout of piping to make it better able to withstand this type of attack. In particular, support piping from heavy frames or other structural strength members not likely to fail or be severely distorted.
3. Adopt measures to prevent elevator platforms from being blown overboard or wrecked.

SECRET

USS INDEPENDENCE (CVL22)

Page 134 of 280 Pages

surfaces. Install the crane machinery in a protected location instead of on the rotating platform.

SECRET

USS INDEPENDENCE (CVL22)
Page 135 of 280 Pages

A. General Description of Machinery Damage.

(a) Overall condition.

All boilers are out of commission because of damage to the stacks, which completely closed the gas passages. The airplane crane was extensively damaged and is inoperable. The airplane elevator platforms and the port boat winch were blown overboard. The starboard boat winch and a considerable amount of shop equipment near the stern were burned out by the fire in this area. The piping of the refrigeration equipment was considerably damaged. No power is available except that furnished by the emergency diesel generators and the forward casualty power diesel generator. Firemain and gas-line piping in the hangar and on and above the flight deck level, aft of frame 50 were severely damaged and these systems are inoperable in these areas except for a few connections on the port side.

(b) Areas of major damage.

Major damage to machinery occurred in the hangar, on this level aft of the hangar, on the flight deck, and on the stacks and cranes above the flight deck.

(c) Primary cause of damage in each area of major damage.

The primary cause of all machinery damage was the air blast. Severe secondary damage was sustained by the machinery in the area of the fire and explosions near the stern. There was also a large amount of secondary damage to piping in the hangar space and on the flight deck from the failure of supporting structures and the impact of various missiles. A small amount of damage to piping in exposed areas (opening of screwed joints) appears to have been caused by heat.

(d) Effect of target test on overall operation of machinery plant.

All machinery is out of action except that which can be operated by power supplied by the two emergency diesel generators

SECRET

USS INDEPENDENCE (CVL22)

Page 136 of 280 Pages

limited operation of one boiler within 36 hours. A major overhaul at a shipyard would be required to affect repairs to stacks, elevators, crane, piping, and shop equipment for wartime operation. It is estimated that at least four days would be required to make emergency repairs to enable the ship to steam at 8 knots. Damage to fire main and gas-line systems would have greatly accentuated the effect of fires and explosions, and would have handicapped efforts to combat them, if the ship had been cruising under war conditions.

NOTE: Temporary repairs were made to one stack after Test A. (Photo 2172-5, 6; pages 683 and 684). No. 2 boiler was lighted off, the main propulsion machinery was warmed up and tested at 20 RPM. No damage to the main engines or their auxiliaries was discovered by this test and the inspections made. However, in view of the severe hull deformation, at the stern and the limited power available for testing, this is not considered to be a conclusive test. It is probable that some misalignment of shafting exists.

B. Boilers.

(a) Air casings.

1. The air casings of boilers were slightly damaged by the blast. The inner rear casing of #2 boiler had 6 tears from 1 to 6 inches long in various locations on the saturated side. The failures occurred in large panels of thin CRS sheet of approximately 1/32 inch thickness. These tears would not have impaired the operation of the boiler and could have been repaired by the ship's force. No rupture was found on the superheater side of any boiler.

2. The outer casings were only slightly damaged. The panels between the economizer and steam drum of boilers #3 and #4 had small tears (one in each panel) about 1 inch long in the upper cover of the panel nearest to the steam drum. (See photo 2172-8, page 685). The economizer casing just above the access of #4 economizer was split at the weld and cracked down to the door opening (See photo 2172-7, page 686).

SECRET

USS INDEPENDENCE (CVL22)

Page 137 of 280 Pages

speed before and after Test A shows that in order to maintain a casing pressure of 28 inches of water, it was necessary to increase the blower speeds from 50 to 100 RPM after Test A. These data are tabulated on a later page of this report.

(b) External fittings.

All boilers were tested hydrostatically before and after Test A. These tests indicate no appreciable change in the tightness of the boilers.

(c) Fuel oil burner assemblies.

Fuel oil pressure assemblies were apparently undamaged.

(d) Brickwork and furnaces.

Brickwork and furnaces were apparently undamaged. No abnormal cracks exist, and plastic and chrome ore are intact.

(e) Steam, water drums and headers.

Hydrostatic tests on all boilers indicate no appreciable change in the tightness of the boilers. (See hydrostatic test data below).

(f) Tubes.

There was no apparent damage to any of the boiler tubes.

(g) Foundations.

The foundations of boilers were inspected and found to be intact.

SECRET

USS INDEPENDENCE (CVL22)
Page 136 of 260 Pages

1. All uptakes below the hangar deck are intact and have but negligible distortion in the form of a very slight dish about 3 feet below that deck.

2. The stacks are crushed and distorted beyond repair at their bases and lower parts where they extend beyond the side of the ship at the hangar deck level. The uptakes were torn free at the connection to the stacks and all uptake openings are completely closed. (See photo 1880-2, 3, 4; pages 687, 688, and 689).

3. The upper parts of stacks #1, 3 and 4 carried away (see photos 1880-5, 6, 7, 8; pages 690, 691, 692 and 693). No. 2 upper stack is still in place but has been crushed so as to partially close the opening. The horizontal portions of all stacks remained in place but, except for #2 stack, the outer casings in this section were ruptured and dished so severely that the inner casings were also heavily damaged. The inner casings of the horizontal portion of #2 stack were only moderately dished.

SECRET

USS INDEPENDENCE (CVL22)

Page 139 of 280 Pages

HYDROSTATIC TESTS ON BOILER # 2

Time	Pressure Before A	Pressure After A
0000	600#	600#
0030	590	588
0100	586	576
0130	578	567
0200	573	557
0230	568	547
0300	563	536
0330	557	525
0400	552	515
0430	547	505
0500	544	495
0530	538	485
0600	532	476
0700	518	457
0800	507	439
0900	493	422
1000	480	409
1100	469	399
1200	455	391
1300	445	383
1400	435	374
1500	425	365
1600	418	357
1700	412	350
1800	409	342
1900	406	334
2000	402	325
2100	398	315
2200	393	312
2300	388	309
2400	384	305

SECRET

USS INDEPENDENCE (CVL22)

Page 140 of 280 Pages

HYDROSTATIC TESTS ON BOILER # 3

Time	Pressure Before A	Pressure After A
0000	600#	600#
0030	565	575
0100	545	558
0130	520	540
0200	500	528
0230	485	514
0300	475	500
0330	465	490
0400	455	480
0430	445	470
0500	430	462
0530	420	451
0600	410	440
0700	390	422
0800	380	409
0900	370	393
1000	370	375
1100	365	355
1200	360	336
1300	355	322
1400	350	308
1500	350	296
1600	350	284
1700	350	274
1800	349	265
1900	348	255
2000	346	245
2100	344	235
2200	343	225
2300	340	217
2400	340	210

SECRET

USS INDEPENDENCE (CVL22)

Page 141 of 280 Pages

Undamaged. All blowers were inspected and operated under normal conditions.

Blower - Air Casing Test
(3 Blowers in use on each Boiler)
(Air Casing Pressure 28 inches of water on all tests)

Before Test A			After Test A	
Boiler #	Steam Press.	Blower RPM	Steam Press.	Blower RPM
1	320#	4350	330#	4400
2	340	4550	360	4600
3	320	4400	340	4500
4	315	4400	325	4500

D. Fuel Oil Equipment.

Undamaged. All fuel oil equipment has been inspected and subjected to operating pressures. The equipment in #1 fireroom was operated incident to the operation of #2 boiler.

E. Boiler Feedwater Equipment.

Undamaged. All boiler feedwater systems and equipment have been inspected and subjected to operating pressures. The feedwater equipment in #1 fireroom was operated while steaming #2 boiler.

F. Main Propulsion Machinery.

1. Undamaged. The main turbines were inspected, tested, jacked over by the jacking gear, then spun both ahead and astern by steam at 20 R.P.M.. There was no evidence of any derangement.

2. Leads left in the bearings of #3 high and low pressure turbines indicate motion of the rotors up to .0095 inch. (See bearing lead data following).

SECRET

USS INDEPENDENCE (CVL22)

Page 142 of 280 Pages

Forward Lead	Before Test A	After Test A	Difference
Port	.007	.002	.005
Top	.011	.003	.008
Stb'd	.008	.002	.006
After Lead			
Port	.0075	.002	.0055
Top	.009	.002	.007
Stb'd	.007	.002	.005

#3 L. P. TURBINE - AFTER BEARING

Forward Lead	Before Test A	After Test A	Difference
Port	.007	.003	.004
Top	.011	.0025	.0085
Stb'd	.008	.003	.005
After Lead			
Port	.0055	.004	.0015
Top	.009	.0025	.0065
Stb'd	.006	.0025	.0035

SECRET

USS INDEPENDENCE (CVL22)

Page 143 of 280 Pages

Forward Lead

Port	.007	.008	.001
Top	.013	.007	.008
Stb'd	.010	.005	.005

Center Lead

Port	.008	.005	.003
Top	.013	.007	.008
Stb'd	.010	.007	.003

After Lead

Port	.011	.003	.008
Top	.012	.006	.008
Stb'd	.0085	.004	.0045

SECRET

Undamaged. The reduction gears were inspected and operated under normal working conditions restricted to 20 RPM by low boiler power available. The teeth and gear internals were inspected while the gears were being jacked over and no derangement was observed. Representative holding down bolts were sounded and found tight.

H. Shafting and Bearings.

1. Apparently undamaged.
2. The shafting and bearing were inspected, both inside and outside the ship. Divers reported no damage to the external fittings and struts or distortion of the shaft as far as they were able to determine.
3. It is doubtful whether the shafting on this ship has maintained its original alignment during the blast due to the severe deformation of the hull at the stern and the probability of main strut displacement. Inspection by divers is not considered to be conclusive evidence of lack of misalignment outside the hull. The low speed (20 RPM) at which it was possible to turn the shafting is not considered conclusive as to performance at high speeds. No facilities for checking the alignment by measurements were available.
4. Maximum movement of shafting in bearings was .021.
(See bearing lead data following).

SECRET

USS INDEPENDENCE (CVL22)

Page 145 of 280 Pages

Forward Lead	Before Test A	After Test A	Difference
Port	.020	.005	.015
Top	.025	.0115	.0135
Stb'd	.018	.013	.005
After Lead			

Port	.0115	.0055	.006
Top	.0195	.009	.0105
Stb'd	.025	.005	.020

#3 LINE SHAFT - AFTER BEARING

Forward Lead

Port	.018	.007	.011
Top	.025	.004	.021
Stb'd	.019	.005	.014

After Lead

Port	.018	.008	.010
Top	.025	.005	.020
Stb'd	.019	.0035	.0155

SECRET

USS INDEPENDENCE (CVL22)

Page 140 of 280 Pages

Undamaged. The lubricating system was in operation during the period the main engines were being jacked over and tested. The entire system functioned properly and lubrication at all points was adequate.

J. Condensers and Air Ejectors.

Undamaged. The condensers and air ejectors were inspected, tested, and operated during the period the engines were being turned over by steam. There were no defects evident. The vacuum in all condensers was maintained at normal values.

K. Pumps.

Undamaged. All pumps have been inspected, tested, and proved satisfactory at rated speed and pressure.

L. Auxiliary Generators (Turbines and Gears).

Undamaged. All main turbo-generators have been inspected, tested, and operated under load. There is no evidence of any derangement.

M. Propellers.

Undamaged. The propellers were inspected by divers. No discernible damage had been sustained.

N. Distilling Plant.

Undamaged. Both distilling plants have been inspected, tested and operated satisfactorily. Neither set shows any evidence of damage and both are producing the same quantity and quality of water as before the test.

O. Refrigeration Plant.

1. The freon piping was ruptured in the meat room due to buckling of bulkheads. The ice machine condenser salt water cooling piping was ruptured at the port outboard corner due to

SECRET

USS INDEPENDENCE (CVL22)

ship's force.

2. The parts of the system were affected as indicated below:

(a) Compressors.

Undamaged.

(b) Motors.

Undamaged.

(c) Condensers.

Undamaged but salt water cooling thereto was ruptured.

(d) Insulation and lagging.

Undamaged.

(e) Miscellaneous valves, switches, controls, fittings, etc..

Undamaged, except that one control box was made inoperable by the buckling of a bulkhead. This condition could be remedied by the ship's force.

P. Winches, Windlasses, and Capstans.

1. Both (port and starboard) units of the anchor windlass and capstan were undamaged and were operated satisfactorily under load after Test A.

2. The starboard boat winch is in a generally burned out condition from the fire which raged in this area. This winch is beyond repair.

3. The port boat winch was blown overboard.

SECRET

USS INDEPENDENCE (CVL22)

Page 142 of 200 pages

inspected, tested, and operated satisfactorily. There is no evidence of any defects.

R. Elevators, Ammunition Hoists, Cranes, Etc.

1. Both elevator platforms were blown off the ship. Guide rails were bent on the port side of the after elevator. When the platforms carried away the wire rope was pulled apart and it is badly entangled in the machinery, also the upper sheaves are bent and out of alignment.

2. The machinery of both elevators, other than the above derangements, appears to be intact.

3. The boat and airplane crane, located on the flight deck starboard, near the island, is not operable without considerable repair beyond the capacity of the ship's force. Emergency repairs to the hoisting gear to make it operable were made by a tender in about 2 days, and it is estimated that this could have been done under emergency conditions within 24 hours. The rotating gear is considered to be beyond repair.

4. The rotating hydraulic motor was torn loose from its foundation and all holding down bolts were sheared. The thrustor brake was torn loose from its foundation. All bolts, except one, of the foundation for the gear box were sheared off. The input shaft was bent down about 10° as shown on photograph 2037-1, page 694.

5. The entire rotating structure of the crane was lifted clear of the track and is leaning outboard at an angle of about 15°. The kingpost was lifted out of its lower bearing and the lower (bronze) bearing was bent and gouged, as shown on photograph 2037-2, page 695.

SECRET

USS INDEPENDENCE (CVL22)

7. The hoisting gear was temporarily inoperable because of casualties to electric cable .

8. There is no evidence that the crane was struck by the elevator platform, but this might have occurred as the elevator platform was blown off the ship.

9. Ammunition Hoists.

Undamaged. All have been operated since the test.

S. Ventilation (Machinery).

1. Undamaged below decks. Destroyed on upper decks.

2. All fans in fan room on 02 deck, serving main machinery engineering spaces, have been inspected, tested, and are operating satisfactorily.

3. All fans on the hangar deck were destroyed by the blast and/or missile effect of flying objects during the explosions that followed the blast.

T. Compressed Air Plant.

Undamaged. All air compressors and adjacent piping have been inspected and tested, operation satisfactory.

U. Diesels (Generators and Boats).

1. Both motor whaleboats were missing, having been blown overboard.

2. The diesel engine of the after 60 kw (casualty power) generator was damaged by blast and fire, and is probably beyond repair. The forward emergency diesel generator (250 kw) was undamaged and has been operated satisfactorily since test A. The diesel engine of the after emergency generator (250 kw) was inoperative (dismantled) before the test but its condition was not

SECRET

USS INDEPENDENCE (CVL22)

Page 150 of 280 Pages

was apparently undamaged.

V. Piping Systems.

1. All piping systems, except as noted below, are intact and have been tested to design or operating pressures. Most of the damage sustained was caused by damaged hull structure or impact of flying objects. Some damage was caused by shock, and a small amount by direct effect of blast pressure.

2. Details of damage to individual systems:

(a) Main steam.

All piping is intact and has been tested at design pressure.

(b) Auxiliary steam.

All piping is intact and has been tested at design pressure except as noted below.

1. The whistle and siren piping was badly twisted and bent above the hangar deck. The whistle and siren themselves appear to be undamaged.

2. Supply lines were torn away from damaged heaters in the hangar deck and badly bent and twisted in way of damaged hull structure. Because of their high location and lagging, it was not possible to determine whether there were any ruptures in the bent lines.

(c) Auxiliary exhaust.

1. All boiler safety valve escape piping above the hangar deck was badly bent and pinched off to such an extent that the lines are completely closed. It was necessary to modify the escape line for #2 boiler so this boiler could be safely operated after the test.

SECRET

USS INDEPENDENCE (CVL22)

Page 151 of 280 Pages

All piping is intact and has been tested to design pressure.

(e) Fuel oil.

All piping is intact and has been tested to design pressure.

(f) Lubricating oil.

All piping is intact and has been tested to design pressure.

(g) Firemain, sprinkling and water curtain.

1. The firemain system except as noted below, is intact and has been tested to design pressure. With the damage sustained, it is not possible to use any hangar deck fire stations except those at frames 85 and 112, starboard side, or any in the damaged areas of the flight deck except the three forward and two after stations.

2. Following is a detailed list of damage to the hangar stations and flight deck risers.

(a) The hangar station at frame 85, starboard, had a pin hole leak at a silver soldered joint which was soldered by the ship's force so the station could be used. The hangar station at frame 64, starboard, was made useless by rupture of the elbow between the deck and riser cut out valves. All hangar stations on the port side were torn away at the hangar deck by ruptured shell plating.

(b) The riser at frame 24, up to fire plugs and faomite units on the hangar deck is intact. However, the strainer for the starboard station is broken off at the threaded union joint which makes the station useless.

SECRET

USS INDEPENDENCE (CVL22)

Page 152 of 200 Pages

deck and to cut out valves for magazine sprinkling and cooling water connections to the air conditioning unit on deck 03. The branch lines appear to be intact.

(d) The riser at frame 64, starboard, was made useless by rupture of the elbow below the riser cut out valve. Damage was caused by distortion of the hangar side plating.

(e) The risers between frames 82-83 and 101-113, starboard side, were torn off directly above the riser cut out valves by impact of planes which were hurled across the hangar.

(f) The risers and stations between frames 62-65, 86-89 and 110-113, port side, were torn away completely with the carrying away of the hangar side plating.

(g) The riser serving fire plugs 1-130, 03-124, 02-134 and 03-132 was ruptured at an elbow and a tee in the carpenter shop. A section of the riser was sheared off at the pipe in the torpedo workshop and the branch line serving the fire plug in crews berthing space C-0201-EL was sheared off at the pipe directly above the fire plug. Damage was caused by distortion of deck and bulkheads to which the piping was attached.

(h) The riser serving fire plugs 02-142, 03-138-1 and foamite station 03-138 is badly bent in compartment C-0201-EL. Small cracks exist in some of the bent sections. Damage was caused by deflected decks and bulkheads.

3. Flight deck fire stations 03-64-2, 03-84-2, 03-132 were either carried away completely or crushed by damaged hull structure. The remaining stations are intact. However, because of the condition of these risers, stations 03-124 and 03-138-1 are inoperative.

SECRET

USS INDEPENDENCE (CVL22)

Page 155 of 280 Pages

in the hangar is intact and has been tested to design pressure. The entire hangar sprinkling system has been made inoperative by failure of the screwed pipe joints and damage to riser supply lines that were not installed inboard of or directly adjacent to framing (bents) In most cases where risers were installed adjacent to frames, they remained intact. However, regardless of damage to the risers, all loops would have been made inoperative by failure of the screwed joints. There was no failure of a flanged joint. Detailed damage to each loop is listed below.

(a) The port riser of the forward loop (which was not installed adjacent to a frame) was carried away by damaged hull plating between the deck connection and the loop valve. About 25% of the loop screwed joints pulled apart by deflection of the flight deck. Since the cut out valve, pipe, and flange appear to be intact, it would have been possible to operate the loop through the starboard riser had the screwed connections been flanged.

(b) Both risers of the loop between frames 70-80 are intact since they are protected by hull framing. About 25% of the screwed connections were pulled apart by deflection of the flight deck. The line would have been intact had the screwed connections been flanged since the flanged joints that were installed remained intact.

(c) The water curtain between frames 83-86 was intact since only flanged joints were installed. However, the risers were sheared off at the weld to the welded neck elbow attached to the inlet side of the cut out valves. The risers were struck by some heavy object. They were not installed adjacent to hull framing.

(d) About 50% of the screwed connections were pulled apart in the loop between frames 89-100 by deflection of the flight deck. The starboard riser (which was installed adjacent to a hull frame) is intact. The port riser (which did not have the protection of a frame) was sheared off at the inlet side of the cut out valve by impact of planes. The loop could have been operated with water through the starboard riser had the screwed connections be flanged.

SECRET

USS INDEPENDENCE (CVL22)

frames 100-101 was sheared off at the deck and at the inlet side of the cut out valve. A 2-inch tear in the starboard riser made it inoperative. None of these risers were installed adjacent to framing. Damage was caused by rupture of structural members.

(f) About 25% of the screwed joints pulled apart in the loop between frames 101-110 due to deflection of the flight deck. The port riser, port side of the loop was carried away. The starboard riser was sheared off at the inlet side of the valve. Damage to the risers was caused by carrying away of hull structure.

(g) About 10% of screwed joints pulled apart in the loop aft of frame 112. The starboard riser is intact. The port riser was carried away with part of the loop. Damage was caused by deflection of the flight deck and carrying away of hangar side plating.

(h) Condenser circulating water.

All piping is intact and has been tested under operating conditions.

(i) Drain main.

All piping is intact and has been tested under operating conditions.

(j) Compressed air.

1. Pipe lines attached to arresting gear was carried away as a result of this equipment coming adrift.

2. All other compressed air piping is intact and has been tested to design pressure.

(k) Hydraulic.

All piping is intact and has been tested to design pressure.

SECRET

USS INDEPENDENCE (CVL22)

Page 155 of 280 Pages

1. All port side stations in the hangar were carried away with the hangar side plating. The three starboard stations were crushed by planes and damaged structural members and the connections were sheared off directly at the side plating.

2. The main lines outside of the shell plating appear to be undamaged although a few sections of shields are torn away and some of the piping bent with the buckling of the shell plating.

3. All risers to the flight deck, except to fueling stations #6 and #8, appear to be intact. The line leading to #8 station is torn away at frame 130 and the line to #6 station is badly bent and twisted as a result of structural damage.

4. The following is a detailed list of damage to the gasoline fueling stations directly outboard of the flight deck.

(a) #1, #3 and #6 stations. Screwed union joints are pulled apart at the gage line valve with no apparent damage to the threads. This is peculiar since the gage and piping to which it is attached is still secured to the bulkhead. It is believed that the union nuts expanded due to heat and the joints were pulled apart by the whipping action of the lines. Except for the above and breaking off of the CO₂ hose valve and the gage glass of #1 station, all piping is intact.

(b) #2 and #4 stations. All piping and fittings of these stations with the exception of the strainer for #2 station were carried away with the catwalk.

(c) #5 station. The inlet nozzle of the after strainer was ruptured between the strainer and flange due to distortion of the bulkhead to which it was attached. The remaining fittings and piping are intact.

SECRET

USS INDEPENDENCE (CVL22)

Page 156 of 280 Pages

from their supports and are held in place by attached piping. Rupture of supports was caused by distortion of the bulkhead to which they were attached. The piping appears to be intact.

(e) #8 station. The flange bolts which were used for securing the strainers to bracket supports were sheared off. Strainer drain lines were also sheared off on both sides of the drain valve and the screwed union joint at the gage valve pulled apart. Damage was caused by structural damage and shock.

5. In view of the condition of the piping of this system, it was impracticable to subject it to a test.

(m.) Aviation lubricating oil.

All piping below the hangar deck is intact. The filling stations in the hangar were crushed by impact from heavily damaged hull and plane parts.

(n) Ice machine room piping.

1. The condenser overboard line was ruptured at the elbow close to the shell of the ship.

2. The screwed pipe joints on both sides of the emergency supply reducing valve were broken off at the threads.

3. All supply lines to the condensers were badly bent and twisted and two of the thermometers crushed.

4. Outboard lines in the port vegetable box and meat room which were attached to the distorted shell plating were badly bent.

SECRET

USS INDEPENDENCE (CVL22)

Page 157 of 280 Pages

5. Damage to the above lines was caused by deflection of the shell plating and bulkhead to which they were attached.

W. Miscellaneous.

All galley, laundry, and machine shop equipment has been tested and found operable. The shipfitters', carpenters' and torpedo workshops were destroyed by explosion and/or fire.

SECRET

USS INDEPENDENCE (CVL22)

Page 158 of 280 Pages

GENERAL SUMMARY OF ELECTRICAL DAMAGE

I. Target Condition After Test.

(a) Drafts after test; list; general areas of flooding, sources.

1. Drafts after test - not observed.
2. List - not observed.
3. After diesel generator compartment was flooded to a height of 6 inches above the bottom of the emergency distribution switchboard.
4. The source of flooding was due to a slow progressive leak from starboard shaft alley.

(b) Structural damage.

Extensive damage to electrical equipment and wiring was a result of the damage to the superstructure and after portion of the hull by the air blast from the bomb. Deformation of bulkheads, panels, decks, and flight deck supports caused rupture of electrical boxes, panels, and appliance frames. Missiles, produced when ship's structure was torn loose from the port side and blown over to the starboard side, or overboard, caused damage to all electrical equipment in their paths.

(c) Damage.

1. The main electric plant, distribution switchboards and main engine and boiler auxiliaries were undamaged and operable, but due to structural damage to stacks, the boilers could not be steamed until temporary repairs were accomplished. The forward and after emergency diesel generators and associated distribution switchboards were undamaged. The after unit was not operable

SECRET

U.S.S. INDEPENDENCE (CVL22)

Page 159 of 280 Pages

for lighting and operating electrical auxiliaries until the main plant could be put into service.

2. Vital ship control telephone communications remained intact and operable. All navigation lights were completely destroyed. It would have been necessary to shift steering control to central station until emergency repairs could be completed on the bridge steering selsyn control cable.

3. The fire control signalling and communication systems were inoperable due to damaged wiring and wiring equipment at operating stations resulting from structural failures.

4. Three of the four heavy machine guns were inoperable electrically due to rupture of power supply cables when mount foundations were deflected upward by bomb blast pressure.

II. Forces Evidenced and Effects Noted.

(a) Heat.

Radiant heat had no appreciable effect except the blistering of exposed paint and destruction of plastic lens on indicating instruments.

(b) Fires and explosions.

A fire was started in after port quarter from an undetermined cause. All electrical equipment in the burned out areas was completely destroyed by the fire and explosions.

(c) Shock.

Some indication of shock on electrical equipment mounted on bulkheads was apparent, although not enough equipment was damaged in this manner to substantiate any definite conclusions.

SECRET

U.S.S. INDEPENDENCE (CVL22)

Air blast pressure from about 240 degrees relative was indicated throughout the major damaged areas due to the manner in which the structural members on which electrical equipment was supported were ruptured and blown over side.

(e) Any effects apparently peculiar to the atom bomb.

The blistering of paint by radiant heat and the presence of radioactive material on exposed surfaces were the effects noted peculiar to the atom bomb.

III. Effects of Damage.

(a) Effect on propulsion and ship control.

No effect on electrical equipment associated with ship propulsion. Damage to bridge steering selsyn control cable, the loss of approximately three pounds of mercury from each of the master gyro compasses and complete destruction of navigation lights were the most vital casualties to ship control.

(b) Effect on gunnery and fire control.

Fire control systems and communications were badly damaged and in most cases inoperable due to structural failures rupturing wiring and wiring equipment. The power and control cables to three of the four (4) heavy machine guns were severed under gun mounts when foundations were deflected.

(c) Effect on watertight integrity and stability.

Electrical damage had no effect on watertight integrity.

(d) Effect on personnel and habitability.

Electrical damage to living spaces were minor, except to CPO quarters aft, which was completely wrecked. The galleys could

SECRET

U.S.S. INDEPENDENCE (CVL22)

Page 161 of 280 Pages

operable from diesel power immediately.

(e) Effect on fighting efficiency.

The fighting efficiency would have been zero due to the destruction of or damage to all aircraft handling facilities. Interior communications remained reasonably operable except for the 3 MC and 5 MC systems, which were largely inoperable or demolished.

IV. General Summary of Observer's Impressions and Conclusions.

(a) This vessel was subjected to the radiant heat of the bomb followed closely by air blast pressure of considerable magnitude. Due to the proximity of this ship to the bomb burst the damage suffered was so extensive that it was rendered inoperable as a fighting craft.

(b) The fact that ship's generators, both main and emergency, all switchboards, lights, automatic telephones, telegraphs and the announcing systems (except 3MC and 5MC) were all working in spite of the severe punishment received, certainly shows that the electrical equipment has been well designed to withstand battle damage.

V. Recommendations.

(a) For installation of electrical equipment such as power and lighting, distribution panels, transfer switches, motor controllers, distribution connections and junction boxes, and similar equipment supported on bulkheads less than 1/2 inch in thickness, "U" bracket foundations fabricated from flat bar and angle bar similar to enclosure sketches CR-1E and CR-2E, as recommended under part C, items F, G, K, and L should be used. When decks and bulkheads are deflected or buckled, the resultant stresses generated would then not be absorbed by the enclosures of the electrical equipment, permitting a more flexible installation.

SECRET

U.S.S. INDEPENDENCE (CVL22)

Page 162 of 280 Pages

conduit and risers through decks should not be attached directly to fixtures, as bends in the conduit and shifting of equipment cause breaks in the cable. The last cable strap supporting the cable before it enters the equipment should be made of very light steel so as to permit it to fail when cable is tensioned.

(c) The present method used to support the sensitive element in Mark VIII, Mod 3, Arma compasses definitely will not withstand the effect of shock. It is recommended that the design of the flotation bowl and float be changed to incorporate some means of retaining mercury in the bowl when subjected to shock or rapid vertical acceleration. Use of a close fitting collar with baffles to suppress wave motion in the mercury are suggested. Bowl support springs between inner gimbal ring and outer bowl should either be increased in number or in size and a better method for securing them devised. Compasses on several of the target vessels had these springs greatly elongated or detached allowing the compass unit to fall to the base of the binnacle.

SECRET

U.S.S. INDEPENDENCE (CVL22)

Page 163 of 280 Pages

A. General Description of Electrical Damage.

(a) Overall condition.

1. The four geared turbine ship's service generators and associated distribution and control switchboards were undamaged, although they could not be operated as the stacks were destroyed rendering the boilers temporarily inoperable.

2. The forward and after emergency diesel generators, starting equipment and associated distribution and control switchboards were undamaged. The forward emergency generator was placed in operation by boarding team "B".

3. The main engine room auxiliaries were undamaged and could be operated from either of the emergency or main ship's service plants.

(b) Areas of major damage.

1. Lighting, power, ventilation and fire control equipment aft of hanger space on second to flight deck inclusive.

2. Lighting, power, ventilation, sprinkling and communication equipment in area of hanger space.

3. Power, communication and fire control systems associated with heavy machine guns on gallery deck level.

4. Navigation, searchlight, fire control and communication equipment on air defense level and above.

(c) Primary causes of damage in each area of major damage.

1. Bomb blast pressure, fire and explosions.

2. Bomb blast pressure, flying fragments and structural failures.

SECRET

U.S.S. INDEPENDENCE (CVL22)

Page 164 of 280 Pages

4. Bomb blast pressure and structural damage.

(d) Effect of target test on overall operation of electrical plant.

1. Ship's service generator plant.

No damage. Could not be operated due to loss of boilers.

2. Engine and boiler auxiliaries.

Operable, (when power was restored).

3. Electrical propulsion.

Not applicable.

4. Communications.

Vital ship control telephone communications remained intact and operable. Loss of mercury in forward and after master gyros rendered them temporarily inoperable. Seisyn steering control cable to pilot house was damaged, although steering stand in central station was operable.

5. Fire control circuits.

Fire control circuits for anti-aircraft systems were generally inoperable.

6. Ventilation.

Motors and controllers for ventilation in hanger space and abaft frame 126 on second deck to flight deck were destroyed or inoperable.

SECRET

U.S.S. INDEPENDENCE (CVL22)

Page 165 of 280 Pages

Navigation lights were completely destroyed. General lighting was intact throughout ship except in hangar space and abaft frame 126 second deck to flight deck.

(e) Types of equipment most affected.

1. Switchboards and switchgear.

Unaffected.

2. Rotating machinery.

Motors for deck, shop and ventilation auxiliaries.

3. Motor controllers.

Controllers for deck, shop and ventilation auxiliaries.

4. Cables and supports.

Cables for ventilation, deck and shop auxiliaries, communication and fire control system were damaged in areas of major damage.

Supports were affected only in areas of structural failures.

5. Interior communication and fire control.

Telephones, announcing and gyro compass equipment, wind direction and intensity transmitters and fire control signalling systems.

SECRET

U.S.S. INDEPENDENCE (CVL22)

Page 166 of 280 Pages

Not applicable, geared turbine drive.

C. Electric Propulsion Control Equipment.

Not applicable, geared turbine drive.

D. Ship's Service Generators.

1. The main ship's service generators installed on board this vessel consist of four 750 KVA, water cooled generators with 7.5 KW exciters driven by steam turbines through reduction gears. Two of these machines are located in the forward fire room, the other two in the after fire room.

2. Immediately following the blast and until debris could be cleared from uptakes and temporary stack constructed, the boilers were necessarily secured and the generators could not be operated.

3. All four generators were started as soon as the above repairs were completed and operated at or near full load, and rated speed. These machines were carefully checked and no damage as a result of test A could be found.

E. Emergency Generators.

1. The emergency generators on board this vessel consist of two 312 KVA General Electric generators with 4.5 KW exciters, driven by 6 cylinder Cooper-Bessemer diesels. One of these machines is located in the forward engine room and the other in compartment C-601 E.

2. There was no damage to either of the above units, resulting from test A. The forward machine was put in operation by ship's team B on reboarding after the test and furnished light and power near full load capacity until temporary stack was completed and boiler lit off. The after diesel was not operable prior test A due to flooding from torpedo damage of November 1943. This unit had been overhauled but satisfactory operation was never obtained

SECRET

U.S.S. INDEPENDENCE (CVL22)

Page 167 of 280 Pages

days and should not be attributed to damage resulting from the test.

3. In addition to the above unit there is one 75 KVA Delco casualty generator installed on port poop deck at frame 140. The only connected load to this machine is one fire and drainage pump located in steering gear room. Provisions are also made for connecting this machine to the casualty power system.

4. The above unit was installed in a compartment located in an area of extensive blast damage and was also subject to intense heat from fires in adjacent compartment, although no direct contact was made with flames. This machine was dislodged from bedplate and foundation was badly distorted. Severe damage resulted from inboard and after bulkhead being torn loose and thrown against this unit with considerable force. The housing between the generator and diesel was cracked about 270 degrees around, access covers and inspection plates were blown off, and one brush holder spring was broken. The starting motor broke loose from its mounting and the 80 volt starting battery consisting of five 6 volt 175 AH SB MD trays was completely demolished by distorted bulkhead crushing the battery rack. The starting and control panel was badly damaged by the overhead being pressed down on framework, meters were ejected, operating handles and control knobs were bent or broken. This machine is considered beyond economical repair.

F. Switchboards, Distribution and Transfer Panels.

1. The ship's service generator and distribution switchboards located one each in the forward and after fire rooms and the emergency diesel generator and distribution switchboards located one each in the forward engine room and compartment C-601 E, frame 101-106 hold were undamaged. The lower section of the after emergency switchboard was flooded to a height of about 6 inches by water entering from shaft alley which rendered this board inoperable. This damage occurred over a period of three to four days after test and could have been avoided had a crew been on board.

SECRET

U.S.S. INDEPENDENCE (CVL22)

Page 168 of 280 Pages

destroyed by fire, and explosions from torpedoes stowed in adjacent area.

3. (a) Power distribution panel No. 1-132-2 and two lighting distribution panels located between frames 130-135 port side on main deck were completely destroyed by fire and bomb blast, photograph 1919-1, page 696.

(b) Foundation brackets for power supply panel and power transfer switch for heavy machine gun mounts #8 and #10 located at frame 105 port side on gallery deck were badly distorted. Switches were operable.

(c) Foundation supports for power panel No. 2-94-1 located at frame 95 starboard side on second deck in passage were distorted and cables partially pulled out of terminal tubes due to deflection in deck over, photograph 1916-7, page 697.

(d) Mounting bolts for manual transfer switch located in gun crew shelter frame 103 starboard side on gallery deck were sheared and cable pulled out of enclosure, photograph 1881-7, page 698. The interior of power distribution panel No. 03-101-1 located in same compartment was badly damaged. Photograph 1881-6, page 699.

(e) Foundation for lighting distribution panel No. 2-72-2 located at frame 71 starboard side on second deck was distorted and cable partially pulled out of terminal tube, photograph 1916-6, page 700.

(f) Interior of power panel and manual transfer switch for heavy machine gun (on stern sponson) located at frame 136, center-line, on main deck was damaged by heat from fire in adjacent compartments. Three of the four A.Q.B. circuit breakers in the power panel were inoperable, photograph 1918-12, page 701.

SECRET

U.S.S. INDEPENDENCE (CVL22)

lighting control station frame 126 starboard side on gallery deck due to blast pressure entering passage forward of compartment, photograph 1985-9, page 702.

Remarks.

In addition to the damage noted above, foundations for several additional power and lighting distribution panels and switches in area of major damage were distorted in a similar manner. It is the opinion of the observer that where the mounting supports were secured from deck to deck or mounted directly on the bulkheads by welding bolts or both, the damage was more pronounced due to the enclosure absorbing the deflected deck and bulkhead stresses. It is recommended that a foundation similar to that shown on sketch CR-1E used where this equipment is mounted on bulkheads less than 1/2" thick.

G. Wiring, Wiring Equipment and Wireways.

(a) Cable.

1. Cables exposed directly to radiant heat of bomb suffered minor damage only. In instances where cables had not been painted after installation the impervious sheath showed indications of surface blistering, while where cable had been painted the heat burned off the paint without any blistering effects to the cable sheath.

2. A peculiar damage to an MHFA-44 cable installed atop the air defense level was noted, the sheath was ruptured and conductors forced out as if they had been subjected to an internal pressure, photograph 1989-12, page 703.

3. Cable damage throughout the areas of major damage was due mostly to structural failures and fires. All cables on island extending above the main battery director level were severed when this structure was blown over side by bomb blast. Photograph 1881-3, page 704.

SECRET

U.S.S. INDEPENDENCE (CVL22)

Page 170 of 280 Pages

area suffered major structural damage. At expansion joints where the flight deck was widely separated a few cables were severed and sheath damaged by shifting structure, photograph 1920-1, page 705. Numerous local cables installed on outside of island and gallery deck structure were damaged by flying fragments.

5. The entire cable installation aft of frame 125 main to flight deck was destroyed by fire, explosions and structure failures. Vertical wireway extending through hangar deck to gallery on bent at frame 92 port side, was badly damaged by inboard deflection of hull plating. Photograph 1917-9, page 706. Degaussing coil cables under flight deck were badly damaged by fire and structural damage at the after port area. Photograph 1989-3, page 707.

6. Several cables in port longitudinal wireway on second deck at frame 116 and 122 were damaged where passing through lightning holes in girder due to buckling in web. The required 5/8" x 1/16" steel liner had not been installed. Photograph 1916-9, page 708 and 1917-2, page 709. The port wireway stuffing tube area through bulkhead 49 on second deck was distorted due to deflection in deck creating short bends in cable and rupturing the conductors in the steering selsyn cable between central station and pilot house. Photograph 1916-3, page 710.

7. Flexible cables to three of the four heavy machine guns on gallery deck level were severed and badly damaged due to gun foundations being deflected upward, also flexible cables to air-plane crane were severed when the crane spindle was ejected out of its base socket.

(b) Wireway supports.

Supports for cables were not damaged except where the structure to which they were attached failed carrying the wireways with it. There was no indication of insufficient strapping or shearing of straps and securing bolts as a direct result of the bomb blast.

SECRET

U.S.S. INDEPENDENCE (CVL22)

of major damage was extensive and too numerous to list individually, several photographs were taken of major damage as follows:

Photograph 1920-5, page 711, frame 40, port side gallery deck.

Photograph 1920-6, page 712, frame 41 port side gallery deck.

Photograph 1920-7, page 713, frame 36 starboard side gallery deck.

Photograph 1920-8, page 714 and 1882-5, page 715, frame 44-45 port and starboard passage focsle deck.

The equipment shown by the above was attached to metal joiner bulkheads which failed when blast pressure entered this area through the access door frame 44-45 port side gallery deck.

2. Damage to wiring equipment in the hangar space area is shown by photographs as follows:

Photograph 1917-6, page 716, frame 71, starboard side at quarter deck control station.

Photograph 1917-7, page 717, at gasoline trunk ventilation control station.

The equipment in this area was damaged by blast pressure and falling structure.

3. Damage to a 20 wire connection box and two casualty power bulkhead terminals is shown by photographs 1916-5, page 718 and 1916-11, page 719. The mounting bolts for the connection box were sheared and the casualty power terminals deflected leaving the terminals inaccessible.

SECRET

U.S.S. INDEPENDENCE (CVL22)

Page 172 of 280 Pages

feet broken and securing bolts sheared. Photograph 1990-4, page 720, island bulkhead. Photograph 1919-10, page 721, frame 28, port side gallery deck. Photograph 1918-7, page 722, frame 115, port side hangar space.

(d) Remarks.

1. The damage noted above is typical of additional damage which occurred in less congested areas to similar wiring equipment.

2. It was noted by the observer that the majority of the damaged equipment was due to the method of installation. The connection distribution boxes and receptacles mounted directly on bulkheads by welding bolts were indirectly damaged by distorted structure. Had this equipment been mounted on extended brackets similar to enclosed sketch CR-2E the stresses would have been absorbed by the brackets in lieu of the equipment enclosure.

3. The last securing strap for any cable entering its equipment should be made of very light sheet steel so as to permit it to shear when any stress is exerted other than supporting the weight of the cable. This would prevent the strap from damaging the cable when the equipment is distorted on its foundation.

H. Transformers.

One bank of three single phase transformers located at frame 129 starboard side on main deck was completely destroyed by fire and bomb blast.

(a) Framework and mountings.

1. One single phase transformer located in gun crew shelter, frame 103, starboard side on gallery deck and one in compartment C-107LA main deck aft for heavy machine guns were blown off foundations and enclosures damaged.

SECRET

U.S.S. INDEPENDENCE (CVL22)

Page 173 of 280 Pages

2. Framework and terminal supports of welding transformer stowed inside compartment at frame 97 port side of gallery deck were badly damaged by bomb blast.

(b) Electrical connections.

1. Transformer for SM and SG radar console located outboard of CIC on gallery deck was burned out and after close inspection found the secondary connections poorly insulated and making contact with enclosure cover. This transformer burned out when energized after test.

I. Submarine Propelling Batteries.

Not applicable.

J. Portable Storage Batteries.

1. Thirty-five portable batteries located in battery charging station, frame 132-136, starboard main deck were completely destroyed by fire.

2. Radar battery consisting of 3-6V-100 AH SBM trays located on gallery deck walkway, frame 45, starboard, suffered the following damage: one tray had sidewall cracked and cell cover lifted, intertray jumpers were disconnected due to securing bolts failing, and there was evidence of acid spillage. This battery was installed in badly deteriorated sheet steel box which offered but little protection and without the benefit of blocks or wedges to prevent shifting. Photograph 1989-7, page 723.

3. Battery consisting of three trays stowed in racks, frame 75 starboard gallery deck, radio repair shop. Two units had cell covers loosened but no acid spillage was noted. The third tray was dislodged from rack and found on deck but appeared to be undamaged. Photograph 1920-2, page 724.

SECRET

U.S.S. INDEPENDENCE (CVL22)

Page 174 of 280 Pages

5. The starting battery for 75 KVA casualty power generator, consisting of 5-6V 175 AH SBMD trays located on poop deck, port at frame 140 was completely destroyed. Battery and rack were crushed by bulkhead being deflected inboard and other equipment including the generator being shifted by the bomb blast. There was also evidence of considerable heat from fires in nearby compartments.

6. All the above damage except those batteries destroyed by fire could have been eliminated or at least minimized if proper stowage and means of securing had been provided. It has been noted on other ships where batteries were located in protective lockers with built in wooden trays to fit individual units and prevent lateral movement and strongbacks over tops of trays to prevent vertical movement, no damage was experienced, even though subjected to considerable shock and blast pressure.

K. Motors, Motor Generator Sets and Motor Controllers.

(a) Rotating equipment for:

1. Engine room auxiliaries.

No damage.

2. Deck auxiliaries.

The motors for No. 1 and 2 boat handling winches located on the port and starboard boat platforms, hangar deck level, frame 125-130 were only slightly damaged. The shafts could not be rotated as the equipment to which they were connected was distorted by bomb blast. The power cables were damaged by fire in the after area.

SECRET

U.S.S. INDEPENDENCE (CVL22)

port side in adjacent areas, the deck was deflected down about 8 inches and the cables were damaged by fire on the second deck, yet the motor, capstan gear and foundation appeared undamaged. Photograph 1918-11, page 725.

The holding down bolts for the port catapult motor were sheared due to deflection in deck which caused the ram foundation on which the motor was mounted to shift. The cable to the motor connection box was partially pulled out due to the method of supporting the cable in conduit which was attached to both motor frame and deck over.

3. Shop service.

All motors and motor driven auxiliaries in the carpenter, shipfitter, aviation and boat repair shops were completely destroyed by fire and explosions.

The motor for an oxygen transfer unit located at frame 141 port side, main deck was destroyed by fire.

Motor for bench grinder in lighting work shop located frame 128 starboard side gallery deck had the mounting base broken.

4. Ventilation.

The motors for ventilation systems 01-83, 01-102, 01-113-1 located in hangar space were blown overboard by blast pressure.

Motor rotors for ventilation systems 01-59, 01-71, 01-71-1, 01-71-2, 01-92-2 located in hangar space were locked due to damage to impeller shafts.

The motor housing was dished, shaft bent and rotor locked for ventilation system 01-101 located in hangar space area.

SECRET

U.S.S. INDEPENDENCE (CVL22)

Page 176 of 280 Pages

destroyed by fire.
The motors (1/4 H.P.) were ejected off mountings and impellers badly bent for two local exhaust blowers in radar control station frame 78 starboard side gallery deck and frame 100 port side gallery deck.

(b) Control equipment for:

1. Engine room auxiliaries.

No damage.

2. Deck auxiliaries.

The controller for airplane crane training and hoisting motor located on the control platform of the rotating structure was blown over side by blast pressure.

Controllers for port and starboard torpedo whip and hoist motors located on the port and starboard bulkheads frame 107-110 hangar space were blown over side of ship with hull structure by blast pressure.

The controllers for port boat handling winch located on outside of bulkhead at sponson, frame 125 hangar deck level, was destroyed by blast pressure, photograph 1918-9, page 726.

The interior of motor controller for the starboard boat handling winch was badly damaged from shock, and heat from fire in adjacent area. The push button enclosure was broken and cable damaged by fire. Photograph 1918-10, page 727.

The controller for stern warping capstan located at frame 135 centerline main deck appeared undamaged although it was subjected to heat from fire in surrounding compartments. The control cables were damaged by fire.

SECRET

U.S.S. INDEPENDENCE (CVL22)

Page 177 of 280 Pages

The controllers for motor driven auxiliaries in carpenter, shipfitter, aviation and boat repair shops were completely destroyed by fire and explosions.

4. Ventilation.

The controller (Ward Leonard) for ventilation system 01-113 located frame 113 hangar space on "bent" was damaged by blast pressure. Photograph 1918-6, page 728.

Controller for ventilation system 01-113-1 located at frame 113 starboard side hangar space on "bent" was blown over the side of the ship.

Controller for ventilation system 01-112 in hangar space was inoperable, reset and start-stop buttons were frozen and enclosure dented.

The mounting bolts for two unit heater control switches (Ward Leonard type 16639) located on "bent" at frame 56 starboard side of hangar space were sheared and switches hanging by cable. Photograph 1917-5, page 729.

5. Sprinkling.

The enclosure and door for hangar sprinkling controller located on bulkhead frame 101, starboard side, third deck was buckled by blast pressure entering compartment through vent trunks.

One of the three water curtain control switches located on "bent" at frame 80, port side of hangar space was blown over side of ship, all mounting bolts were sheared on one and two on the other switch. Photograph 1882-2, page 720.

SECRET

U.S.S. INDEPENDENCE (CVL22)
Page 178 of 260 Pages

were mounted was badly distorted. Photograph 1917-8, page 706.

One of the three water curtain control switches located at frame 92, port side hangar space was blown over side of ship, all mounting bolts were sheared on one and cables severed on all. Photograph 1918-5, page 731.

The control cables for two water curtain control switches located at frame 118, port side of hangar space were damaged at last cable securing strap. Photograph 1918-8, page 732.

6. Refrigeration.

The controller (G.E. serial no. 285186) for refrigeration circulating pump motor no. 2 mounted on bulkhead 126 port side on third deck in ice machine room was badly damaged due to buckle in bulkhead. The line contacts were broken, relays distorted and push button broken in two pieces. Photographs 1916-12, page 733 and 1917-1, page 734.

Remarks.

Controller damage generally was due to structural failures, with some equipment being damaged by fire, explosions, and direct blast pressure. Although the method of mounting in most instances was not responsible for the damage, it is recommended that these units where mounted on bulkheads less than 1/2" thickness, foundations similar to that shown on sketch CR-1E under Item F be employed. This type foundation would have definitely saved some of the units in existing locations and if employed in protected spaces and heavier structural members used for a base, damage to this type equipment would have been considerably lessened.

L. Lighting Equipment.

(a) Navigation lights.

1. All navigation lights located above the air defense

SECRET

U.S.S. INDEPENDENCE (CVL22)

lever were blown over side of ship when this structure was carried away by blast pressure.

2. The cut off shields were distorted, globes and lamps broken on the side lights located on port and starboard side of flight deck.

3. Masthead light mounted on forward end of pilot house was blown off foundation.

4. Range light was blown over side with mast structure.

5. Screen and speed light mounted under flight deck ramp was damaged beyond repair.

6. Mounting bolts were sheared and lamp broken on after anchor light .

7. Wake and blue stern lights were blown off foundation. White stern light cut off shields were bent and globes broken.

(b) Landing lights.

1. A total of 17 pairs of deck edge landing lights were installed, 50% were totally destroyed, 25% were partially destroyed and 25% were moderately damaged. Photographs 1989-1, page 735 and 1881-4, page 736.

2. One bar light located at frame 96, port side gallery walkway was blown off foundation and one damaged. Photograph 1989-4, page 737.

3. The extension arms for the bow designation lights were broken. Photograph 1919-11, page 738.

(c) Compartment lighting fixtures.

1. Lighting fixtures under flight deck for hangar space area were totally out of service, lamps were broken, reflectors

SECRET

U.S.S. INDEPENDENCE (CVL22)

2. The 500 watt flood lights mounted on extension bracket off the outboard structure of gallery deck walkway were damaged by falling structure. Photograph 1985-11, page 744, shows one fixture located in area of major damage, lens was broken and portable cable severed.

3. Desk and deck fixtures in offices and living spaces on main to gallery deck forward of frame 45 and below main deck forward, amid and aft were only slightly damaged. Nearly all fixtures were placed in service as soon as power was available. Where fixtures were damaged it was due to falling furniture and shifting of metal joiner bulkheads. Only a small quantity of lamps were broken. Photographs 1920-6, page 712 and 1920-7, page 713.

(d) Lighting switch-boxes.

1. The lighting distribution switch-boxes were the cast aluminum type of which several had the mounting feet, enclosure, cover or interior damaged due to buckling of the bulkheads on which they were mounted. In all cases the boxes were secured by welding the mounting bolts directly to the bulkheads, and when these were buckled by deflection in decks the stresses were absorbed by the box enclosure. Photographs listed below at designated location shows above damage. No. 1989-8, page 745, type 4X distribution box in flight deck control station; 1989-8, page 745, type 12X distribution box located in flight deck control station; 1916-8, page 746, type 12T distribution box located at frame 119 port side second deck; 1916-10, page 747, type 12T distribution box located at frame 113, starboard side, second deck; 1916-4, page 748, type 12X distribution box located at frame 53 starboard side, second deck; 1917-3, page 749, type 12T distribution box located at frame 104, port side third deck.

2. The plastic lens in anchor light indicator and control switch located on left side of control panel at quarter deck station frame 71, starboard side of hangar deck was damaged by

SECRET

U.S.S. INDEPENDENCE (CVL22)

radiant heat of bomb, the mounting bolts were sheared and cable partially pulled out of enclosure. Photograph 1917-6, page 716.

3. The beacon light relay control panel mounted on flat bar "U" brackets welded on inside of port bulkhead of island structure (air defense level) was found on deck, the brackets were only tackwelded.

(e) Remarks.

The damage to this equipment was secondary and due mostly to stresses transmitted through decks and bulkheads. To prevent the equipment from absorbing these stresses it is recommended that brackets similar to that shown on sketch enclosure CR-2E (under Item G) be adapted for all installations where bulkheads are less than 1/2" in thickness.

M. Searchlights.

(a) Prior to test A, two G.E. 24" searchlights were installed on the searchlight platform located approximately seven feet above the main battery and fire control station on island structure at frame 54 and 56. This platform and the searchlight mounted thereon were blown overboard as a result of the bomb blast. Photograph 1881-3, page 704.

(b) There were four G.E. 12" signal lights, type 12-G-30 installed in the following locations:

#1-frame 54, port, main battery and fire control station.

#2-frame 54, starboard, air defense level.

#3-frame 56, port, air defense level.

#4-frame 58, starboard, signal platform.

#1 signal light was blown overboard. #2 signal light, mounted on shield was dislodged from bracket and found lying on

SECRET

USS INDEPENDENCE (CVL22)

Page 182 of 280 Pages

resulting in following damage: reflector and lamp broken, base distorted, drum bent and one shutter operating handle broken. Approximately 50% of exterior surface had paint blistered and blackened by radiant heat from bomb. It was noted that the front door glass was not broken. #4 signal light was removed from ship prior to test as per instruction from staff.

(c) Remarks.

Two of the three 12" signal lights installed at time of test, were damaged by falling on deck and the remaining one blown overboard. Damage in each case was caused by light becoming dislodged from bracket due to vertical acceleration of the ship. Locks installed on base of these lights to prevent this dislodgement were removed by operating or maintenance personnel and never replaced, or possibly never installed. Therefore it is believed by this observer that if these locks were attached to the base of the light by means of safety chain or similar material there would be less chance for loss of this part when lights are removed for repairs or relocating.

N. Degaussing.

(a) The degaussing installation on board this vessel consists of an "M" coil encircling the ship on the third deck, an "F" coil forward and a "Q" coil aft located below the flight deck except at the extreme bow and stern where it runs below the main deck. The M and F coils are supplied from a M-G set located in compartment A-401-E. The supply for the Q coil is from a M-G set in compartment C-508E. The remote control and indicating panel is located in the chart house, local operation is by means of controls in the M-G rooms.

(b) The "Q" coil cables were severed at the port after end of gallery deck due to ship's structure to which secured being blasted away. These cables also suffered damage from fire in this area. Photograph 1990-4, page 720.

SECRET

U.S.S. INDEPENDENCE (CVL22)

otherwise undamaged. The control boxes for these coils were torn off shield, boxes were slightly distorted and cable pulled out. The fittings for these boxes were not damaged and the mounting feet were bent but not broken. They were of sheet steel construction. It was noted that the above degaussing equipment and several severed cables was all that remained at this station as all other equipment and shields were blown overboard.

O. Gyro Compass Equipment.

(a) The forward master gyro compass located in central station A-415-C spilled approximately three pounds of mercury from the flotation bowl. This is believed to have been caused by shock transmitted through hull of vessel to compass mounting. The top of the binnacle was dented slightly, possibly by some falling object. The after master gyro compass located in compartment C-402-C also suffered a loss of mercury similar to the forward compass. No other damage to this unit was observed. The ship's gyro electrician replaced the spilled mercury in both compasses and they were placed in operation. No sun azimuth was taken but there is a two degree constant error between the two units. The error for either compass and the cause was not determined but was probably due to improper or dirty mercury added or a shift in balance weight due to shock. The above compasses are Arma Mark VIII mod. 3.

(b) The bearing repeater located at the main battery and fire control station was blown clear of ship by the bomb blast. Course repeater located at forward end of air defense level on open bridge had bezel glasses broken and card punctured by fragments. Bearing repeater located on after end of air defense level has steel mounting plate bent, base of repeater broken and housing distorted by blast. The port pelorus was struck by shield around open bridge and pedestal broken half way up from base, alidade is missing. Starboard pelorus appears to be slightly out of line due to deck deflection and four inch crack in base of pedestal. This unit has been tested and is operable. Steering repeater in pilot house shows evidence of shock mounting having been strained but otherwise is in good condition. Bearing repeater in Captain's sea cabin has bezel glasses shattered, probably as a result

SECRET

U.S.S. INDEPENDENCE (CVL22)

which failed due to washers on securing bolts pulling through rubber sets. The above repeaters and their associated stands, brackets, etc., are cast aluminum. Photographs 1919-12, page 750, 1880-12, page 751, 1881-1, page 752, 1881-2, page 753, and 1989-10, page 754.

(c) The dead reckoning equipment consists of two units, one installed in CIC and one in the chart house. These units are identical except for method of mounting. The tracer in CIC is table mounted and the one in chart house is mounted vertically against the outboard bulkhead. Neither of these units was operable prior to test A and no additional damage as a result of this test was apparent. The speed and course input and analyzer appear to be operable.

(d) Remarks.

It should be noted that the damage to the master gyros described in paragraph one, was the only electrical damage below the third (armored) deck as a result of test A. Similar damage was observed on other ships after test A and there were numerous examples after test B where master gyros were the only electrical equipment damaged. In view of the vital input to radar and fire control equipment supplied by these compasses and the fact that unless correct these input are next to worthless, some means should be devised whereas this failure would be eliminated. Bearing repeaters with shatterproof bezel glasses became non-transparent when struck by missiles or falling objects and instruments were rendered useless. It is recommended that plastic lenses be used except in exposed locations where subject to direct rays from bomb, radiant heat seriously affects transparency of plastic lenses. Instrument mounted in aluminum enclosures where subject to severe shock or blast pressure usually had mounting feet broken. Also aluminum pedestal mounted instruments suffered cracks in bases and broken columns. It is believed this damage would be eliminated or at least minimized by using sheet steel for enclosures and steel tubing for pedestal. Some bearing repeaters and other instruments were mounted on heavy steel plate, this rigid mounting absorbed none of the shock resulting

SECRET

U.S.S. INDEPENDENCE (CVL22)

Page 185 of 280 Pages

failures of instruments mounted on rubber shock mounts were numerous. Common cause of failure was due to small washer pulling through rubber set, allowing instrument to be damaged by falling on deck or in some instances, damaging other instruments on which they fell.

It is recommended that the rubberset be made heavier and that the flat washer which rests against the rubber be made part of the securing bolt and as large in diameter as practicable, this will lessen the possibility of washers being lost and improper ones being substituted during installation.

P. Sound Powered Telephones.

(a) Prior to the test most of the headsets and handsets were removed from the ship as per instruction from staff. Of those remaining on board, no damage was observed to any of the headsets. One handset located at flight deck control station, frame 128, starboard gallery deck, suffered a broken transmitter retainer ring. One handset located at frame 57 hangar deck, port, had ring and cap missing and transmitter diaphragm punctured.

(b) One four gang jack box located on port bulkhead of air defense level was torn loose from mounting due to deflection of bulkhead. Three type J phenolic jack boxes mounted on outside of island structure was damaged by fragments from material on flight deck. One aluminum type single jack box located on operating level of A/P crane had mounting feet broken and cable pulled out by blast.

(c) One 10 circuit switchbox (49JY) cast aluminum type located on port side of air defense level had mounting feet broken due to deflection of shield.

(d) One telephone selector switch located on port bulkhead, air defense level was torn loose from mounting by blast. Photograph 1990-4, page 720.

SECRET

U.S.S. INDEPENDENCE (CVL22)

station had mounting bolts sheared and fell on deck.

(f) Telephone jack boxes and control equipment mounted on gun and director shield were torn loose and generally damaged where shield was badly distorted or parted, otherwise this equipment was undamaged. Photograph 1919-10, page 721.

Q. Ship's Service Telephones.

(a) The 100 line Automatic Electric exchange and its associated batteries, ringing machines, charging equipment, etc., located in L.C. room was not damaged as a result of test A.

(b) Line equipment consisting of approximately 150 units installed throughout the vessel suffered damage as follows: Several type A phones located in officers country on forecastle and gallery deck forward were damaged due to falling off desks, some type B phones mounted on joiner bulkheads in the same area were damaged due to the failure of these bulkheads and dislodged furniture being thrown against these units. Similar damage to the above occurred in ship's office space on starboard 2nd deck between frames 87 and 101. One type C phone located on port hangar deck at frame 59 had hinge on cover broken and cable severed by falling structure. One type B phone in auxiliary chart house and one type B phone in radar control station, frame 78, starboard gallery deck had phenolic cases broken, possibly due to being struck by some object as this was an area where considerable equipment was dislodged and adrift. One type B phone located at frame 45 on port gallery deck had dial mechanism ejected due to bulkhead being deflected. One type B unit located in chart house had handset broken. All telephone equipment located in area aft of frame 126 between main and flight deck was destroyed by fire.

(c) The ship's service telephone system was put in operation by the ship's crew on returning after test A and except for the damaged units described above and possibly a few units suffering from undetected cable damage operated satisfactorily. This operation

SECRET

U.S.S. INDEPENDENCE (CVL22)

R. Announcing Systems.

(a) The 1, 2 and 3 MC amplifier and control racks located in central station were undamaged by test A. The 3 MC transmitter station located on port side of air defense level had aluminum case distorted due to deflection of shield on which mounted. The 1 MC transmitter station, same location as above 3 MC unit suffered similar damage. The 1 MC transmitter station located at quarterdeck station frames 71-80, hangar deck starboard has cover warped, difficult to close. There was no damage to any of the above transmitter stations that would impair their operation. In view of the fact that well over 200 reproducers are installed on board this vessel and a considerable number of these units were damaged, general statements only as to the areas most affected and causes of damage will be given in view of an attempt to list similar damage to all the individual units involved. Practically all the reproducers located on the port gallery walkway were either blown overboard by the blast or crushed when the walkway hinged up alongside the ship's structure. On the starboard side of the flight deck the speakers were mounted on tripods facing directly into the blast and most of them were either blown over the side or horns folded back by the blast pressure. Several of these speakers selected at random from those remaining mounted and others picked up from the flight deck and walkway were tested and in most cases were operable. They had no directional characteristics due to horns being either flattened or folded back over element but the fact they remained operable when located in an area subjected to a pressure wave of sufficient force to cause extensive structural damage is in itself considered noteworthy. These were RCA weatherdeck reproducers, Grade II, type H, equipped with blast valves. On the port side of island structure approximately 10 feet above flight deck were a nest of 3 reproducers. Two of these were blown off their mountings by the blast and were found lying on the flight deck. The third unit was badly distorted. All three were tested and are operable. There were 14 reproducers mounted on overhead of hangar deck, 12 of these units were dislodged from their cases and fell to the deck below. These were flat type RCA reproducers, class L and S, model MI 2917-J, 1000 cycles, 5 watts. This type speaker is

SECRET

U.S.S. INDEPENDENCE (CVL22)

spaces and was ejected from cases where ever mounting was disturbed by shock or bulkhead buckled due to deck deflection. The method used for securing element in case was not designed to withstand effect of shock. Most reproducers located aft of frame 126 on main poop and gallery deck were totally destroyed due to bomb blast, detonation of torpedo warheads and fire which devastated this area in general. On the main, forecastle and gallery decks forward, several speakers were damaged or rendered inoperable by cable pulling out due to collapse of joiner bulkhead on which mounted and being struck by other equipment which was dislodged by the blast. A few of the flat type RCA speakers mentioned previously were ejected from their cases due to deflection of bulkhead on which mounted in this forward area. On the second deck there were isolated cases of speaker damage from mounting failures due to buckling of bulkheads and being struck by other equipment. These speakers were often mounted direct on bulkhead with welding pads, buttons or very short stools which allowed no flexing of mounting when bulkheads were distorted.

(b) The 5 MC amplifier and control racks located at frame 46, port gallery deck were severely damaged due to blast pressure distorting bulkhead and deck and several spare part boxes stowed in this room being thrown against this equipment. The transmitter station located on port side of air defense level has hinge bent for cover making it impossible to close and retainer ring broken and motor unit jarred from microphone. This damage was a result of deflection of shield on which mounted.

(c) There were 4 bull horns installed prior to test A in the following locations:

- #1 - low on #4 stack facing aft.
- #2 - below SL platform facing port.
- #3 - below navigation bridge facing forward.
- #4 - below SL platform facing aft.

SECRET

U.S.S. INDEPENDENCE (CVL22)

as a result of the blast. No. 3 suffered only minor dents in housing apparently from missiles and is believed to be operable.

(d) The following Operadio intercom announcing systems are installed on board this vessel.

4MC - damage control.

19MC - flight announcing.

20MC - radar announcing.

21MC - Captains command.

The damage noted below was obtained by visual inspection of the unit, no operating test were conducted by ship's electrician's due to pressure of other work. The 4MC unit installed in CPO quarters was destroyed by fire and blast pressure which destroyed practically all equipment located in this area. One 19MC unit installed on port side of air defense level, frame 55, was ejected from case and unable to locate, two of the four shock mountings on case failed due to small washers pulling through rubber sets, the remaining mounts appear to be strained. This unit was mounted on shield which was deflected inboard. One 4MC unit located on hangar deck, frame 85, was ejected from case and damaged by falling on deck. One 19 MC unit located on joiner bulkhead of aviators ready room was rendered inoperable by ruptured cable caused by collapse of bulkhead. One unit in after radio room had cable pulled out due to buckling of bulkhead on which mounted. One 20MC unit installed on forward shield of air defense level has pull out handle broken and enclosure slightly distorted by the blast pressure but appears to be operable. One 21 MC unit installed on after shield of air defense level has unit jarred out approximately three inches and terminal block broken. One 20 MC unit located on forward shield of air defense level has handles bent and case dented but appears to be operable.

SECRET

U.S.S. INDEPENDENCE (CVL22)

Page 190 of 280 Pages

Photographs 1990-3, page 755, 1985-11, page 744, 1881-2, page 753, 1920-10, page 759, 1880-9, page 756, 1917-6, page 716, 1880-10, page 757, 1917-7, page 717, 1882-4, page 739, 1918-4, page 758, 1919-5, page 760, 1916-5, page 718, 1917-12, page 742, 1920-5, page 711, 1920-11, page 761, and 1989-6, page 762.

S. Telegraphs.

(a) Steering course telegraph transmitter located on open bridge has lense damaged due to radiant heat from bomb. This lense is no longer transparent and renders the instrument useless. No other damage to this unit was apparent from visual examination. Ships electricians state that this system has been energized and checked and all stations except flag platform on flight deck aft which has blown off ship operate satisfactory. These stations include pilot house central station, secondary conn, steering gear and open bridge. How latter instrument was read with lense in condition described above is not known, possibly was removed during test. Photographs 1881-2, page 753 and 1881-1, page 752.

(b) Engine order and shaft revolution transmitter located in pilot house has cast aluminum stand broken near base, believed to have been caused by shock transmitted through hull to base of instrument. There is no evidence of pressure in this area or any indication of this instrument having been struck by other objects. This unit is pedestal mounted to deck. Photograph 1989-9, page 763.

T. Indicating System.

(a) HDHE.

Wind direction and intensity transmitter located on starboard yardarm was blown off ship as was mast to which attached. The transmitter located on end of airplane crane boom has rotor cups and direction rod and vane missing and spindle bent. Indicator located at fly control on shield was damaged due to mounting failure caused by deflection of shield inboard. Cast aluminum mounting feet were broken off and case cracked. Indicator mounted on forward shield of air defense level had plastic lens damaged due to radiant heat from bomb. Dial is no longer visible rendering instrument useless. Indicator located at landing signal station was blown off ship along with

SECRET

U.S.S. INDEPENDENCE (CVL22)

blast but otherwise undamaged.

(b) HC.

Wind intensity transmitter installed on port yardarm of island structure mast was blown overboard. Indicator switch and buzzer located in chart house was dislodged from mounting and found lying on chart desk with no apparent damage to unit. Recorder installed in Aerological office was removed from ship prior to test.

(c) F- Fire alarm system.

Approximately ten percent of the fire alarm circuit are defective due to broken thermostats and damaged leads. The fire alarm panel located in central station appears to be in good condition and operable.

(d) RC - Catapult ready light.

Indicator located at catapult control station on starboard gallery deck walkway frame 22 has mounting broken due to blast and lens damaged by radiant heat of bomb to such an extent that colors are no longer discernable.

(e) RF - Flight control ready light.

Indicators installed on fly control station and landing signal station have been blown overboard by blast. Indicator at arresting gear station frame 90 port is badly damaged, believed to have been struck by fragment from special material exposed for test on flight deck.

(f) W - Whistle operating system.

Operating solenoid blown off stack.

SECRET

U.S.S. INDEPENDENCE (CVL22)

Page 192 of 280 Pages

plastic lens so badly damaged by radiant heat from bomb as to make reading of any indications impossible.

N - Rudder angle indicator.

Y - Pitlog speed and distance indicator.

31PD10 - SM radar range indicator.

31PD20 - SK radar range indicator.

31PD30 - SG radar range indicator.

(h) A - Officers call bell system.

This system is intact and operable except for a few circuits on forecastle and gallery deck forward where bells, push-buttons, etc. have been dislodged from mountings or cable pulled out of unit due to failure of joiner bulkhead to which attached.

(i) E-VT and SP telephone call bell system.

1 EX, cruising and miscellaneous and 2 EX, ship control have been tested and are satisfactory, 3 EP, engineers cruising and miscellaneous is intact and operable except for smoke watch station on open bridge. 4 EP, A/C control and 5 EP, fire control are out of service due to severed and damaged cables in vicinity of island structure and gallery walkway. Cable damage in this area due to separation of ship structure and fragment damage.

(j) The following systems have either been energized and tested or all units of each system thoroughly inspected and no damage noted.

1 EC - Main engine lube oil alarm.

2 EC - Auxiliary gen. lube oil alarm.

SECRET

U.S.S. INDEPENDENCE (CVL22)

Page 193 of 280 Pages

VS - Valve position indicator.

LB - Steering emergency alarm.

K - Shaft revolution indicator.

Photographs 1920-9, page 764, 1881-2, page 753, 1881-3, page 704, 1881-1, page 752, 1919-10, page 721, 1917-6, page 716, and 1917-7, page 717.

U. I.C. and A.C.O. Switchboards.

No damage.

V. Fire Control Switchboards.

No damage.

W. Miscellaneous.

(a) Ranges.

The heating element for an Edison Hot Point Range in W.O. pantry at frame 33 to 35, port side on 3rd deck was dislodged due to shock being transmitted through decks and bulkheads. The electrical connections were not damaged.

(b) Range Controllers.

The front cover and control panel for the above range was dislodged and hanging by wiring. Photograph 1917-4, page 765.

(c) Non-radiant heaters.

Minor damage to heaters was observed, expanded

SECRET

U.S.S. INDEPENDENCE (CVL22)

Page 194 of 280 Pages

one occasion which was caused by a falling door, on one other occasion
the elements were bent but operable. Photograph 1989-5, page 766.

SECRET

U.S.S. INDEPENDENCE (CVL22)

Page 195 of 280 Pages

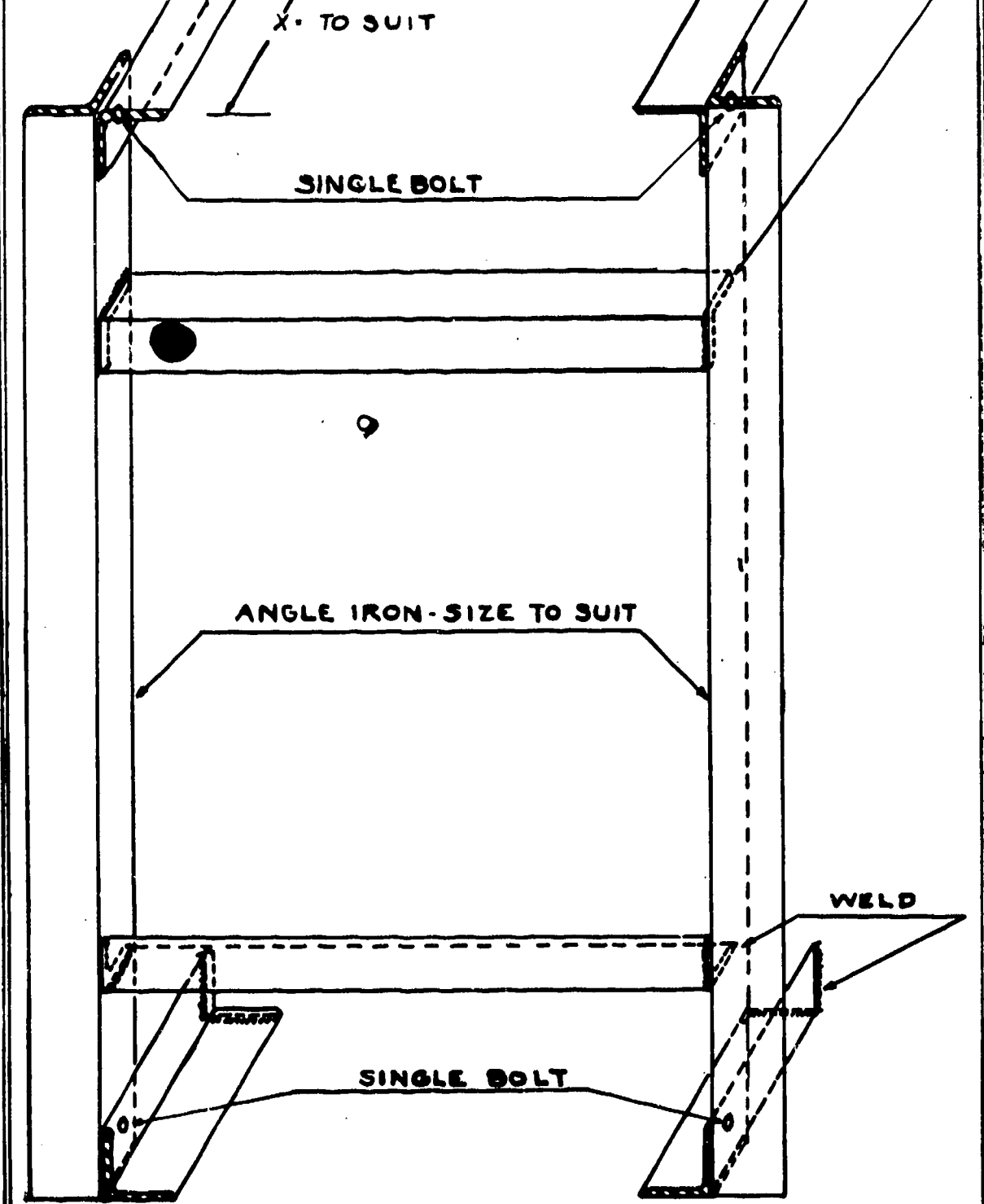

TYPICAL FOUNDATION FOR
 CONTROLLERS; PANELS AND TRANSFER SWITCHES
 WHEN MOUNTED ON BHDS. LESS THAN 1/2" THICK

SKETCH CR-1E.

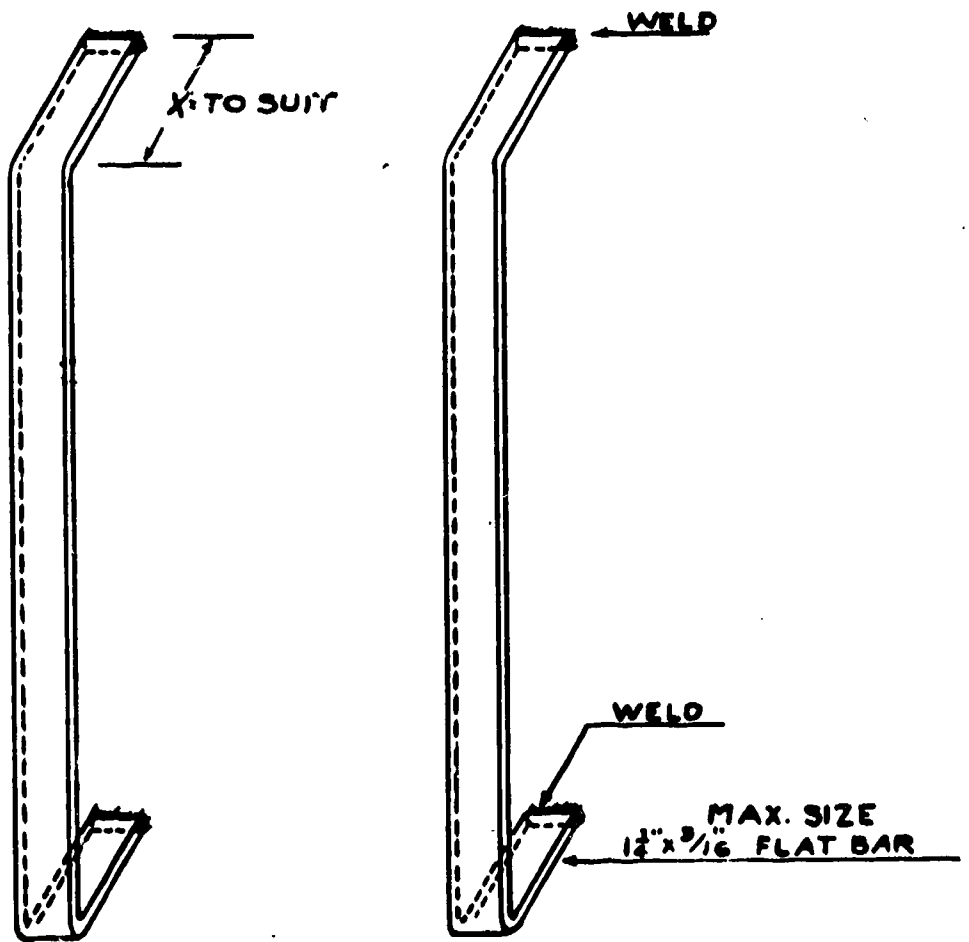

TYPICAL FOUNDATION FOR
 JUNCTION, CONNECTION AND DISTRIBUTION BOXES
 WHEN MOUNTED ON BHDS. LESS THAN 1/2" THICK

SKETCH CR-2E

SHIP MEASUREMENT DATA
AND
SHIP DAMAGE DIAGRAMS

TEST ABLE

SECRET

U. S. S. INDEPENDENCE (CVL22)

Page 198 of 280 pages.

A. General Considerations.

A deck survey method was developed to determine the twist and longitudinal bending of each target vessel's hull girder resulting from an air or underwater burst of the atomic bomb. The procedure developed is as follows:

1. Select transverse sections. The maximum number of transverse sections used on any ship was six.

2. At each transverse section, select stations at which rod readings are to be taken. Center punch these stations in the deck. A minimum of five stations were used at each transverse section.

3. Establish throughout the length of the ship, by use of a surveyor's transit, a reference plane approximately parallel to the deck.

4. Take rod readings at every station on each transverse section.

5. Plot rod readings relative to a straight line representing the reference plane.

(a) Readings at each transverse section are plotted in order to obtain the configurations of individual sections and also to establish the relationship between sections.

(b) Readings at desired distances from the centerline are plotted in order to establish sheer lines. On most ships the actual readings are corrected for changes in sections resulting from local damage.

6. Repeat steps 3, 4, and 5 after the test using the stations established in steps 1 and 2.

SECRET

USS INDEPENDENCE (CVL22)

test plots in order to compare the conditions existing at the times of the two surveys.

The reference planes used in the before test and after test surveys are not necessarily parallel. Their relationship can not be accurately determined because bench marks established before the test may be affected by local damage or by changes in hull alignment. Therefore it is possible to determine only the relative movement of sections. The reference planes are disregarded after completion of the initial plots.

Twist of the hull girder is determined by superimposing one after test transverse section on the similar before test section and comparing the configurations of the remaining sections as shown on plate 42. Hog or sag is determined by superimposing before and after test plots of sheer as shown on plate 41.

The camber curves indicated in all plots are faired lines and do not show local deformation which may exist between the five station points. Camber curves are shown on plate 42.

B. Measurements.

A survey of the hangar deck was conducted at Terminal Island Naval Shipyard on February 28, 1946. The hangar deck was again surveyed at Bikini Atoll on July 11, 1946. The surveys cover only the area between the forward and after elevator wells. The plots of the two surveys were superimposed and are shown on Plates 41 and 42. The plots indicate no significant change in the ship's girder between the two elevator wells. Deep local deflections are shown in the plot of the sheer lines. A maximum deflection of 26 1/2 inches near frame 91, at the centerline, is recorded on Plate 41.

A survey of the flight deck was conducted at the same time the hangar deck was measured. The two surveys were correlated in order to show relative positions of the two decks. Measurement of the displacement of the main deck and the bulkheads between the hangar and main decks were recorded and used to complete the plots, in section, shown on Plates 5 to 25,

SECRET

USS INDEPENDENCE (CVL22)

Measurements were taken and plotted to show the damaged condition of the main transverse bulkheads between the main and third decks (Plates 26 to 38 inclusive). Measurements were also taken on the outboard side of the port blister and plotted to show the deformation in the area from the main deck down to number 5 longitudinal (Plates 39 and 40).

C. Scratch Gage Data.

Deflection scratch gages were installed to measure movement between selected decks as shown on pages 245 and 246.

SECRET

USS INDEPENDENCE (CVL22)

Page 201 of 280 Pages

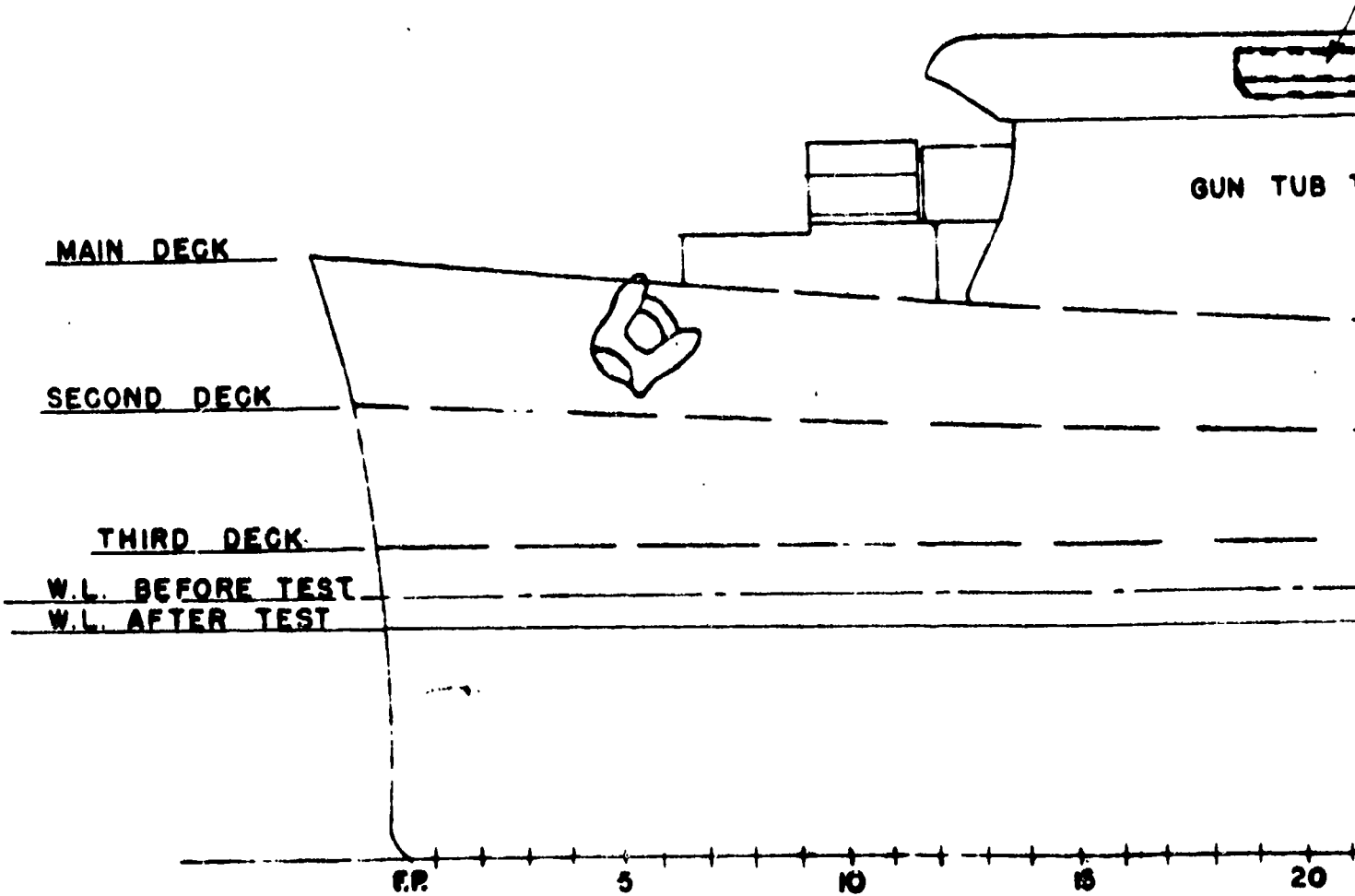

MAIN DECK

SECOND DECK

THIRD DECK

W.L. BEFORE TEST

W.L. AFTER TEST

GUN TUB

F.P.

5

10

15

20

ROLLER CURTAINS CARRIED AWAY
TO STARBOARD BY BLAST.

GUN TUB MISSING

WALKWAY

GUN TUB TIPPED UP

WALKWAYS NOT
USEABLE

OUTBOARD BULWARK BENT DOWN

20

25

30

35

40

45

2

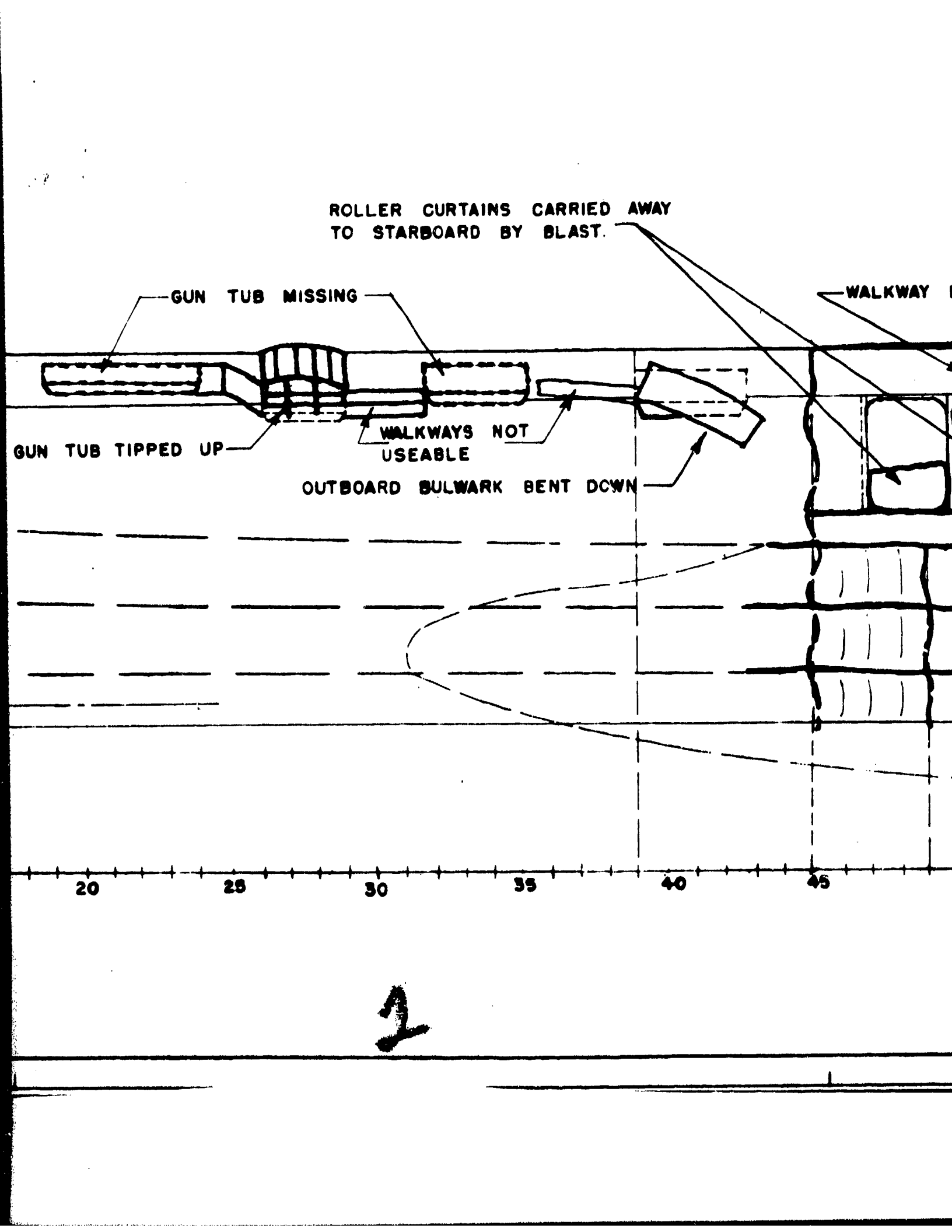

AND
BOA
ADJA
AWAY
(FRA

CARRIED AWAY BY BLAST

FLIGHT DECK BUCKLED
UPWARD SHARPLY AT E

DECK PARTED AT EXPANSION JOINT

WALKWAY MISSING

SPON

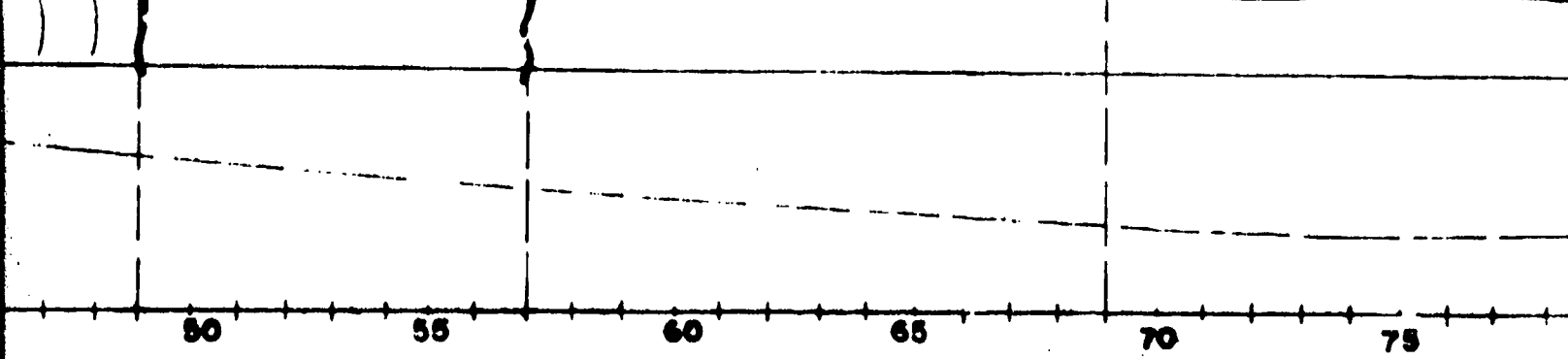
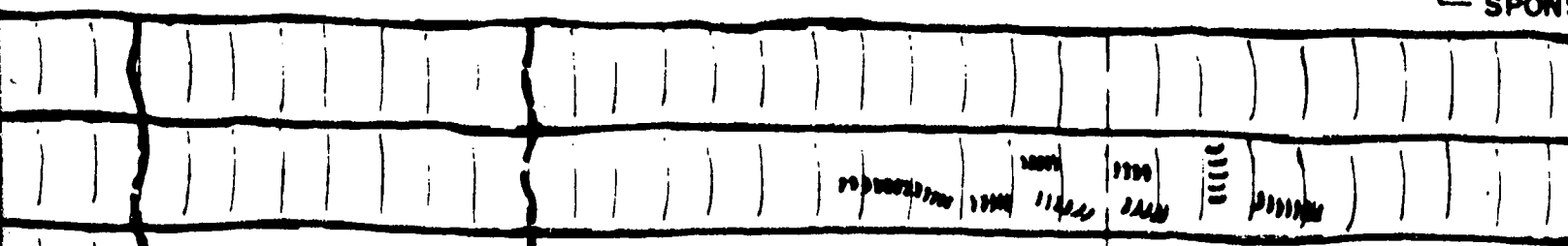
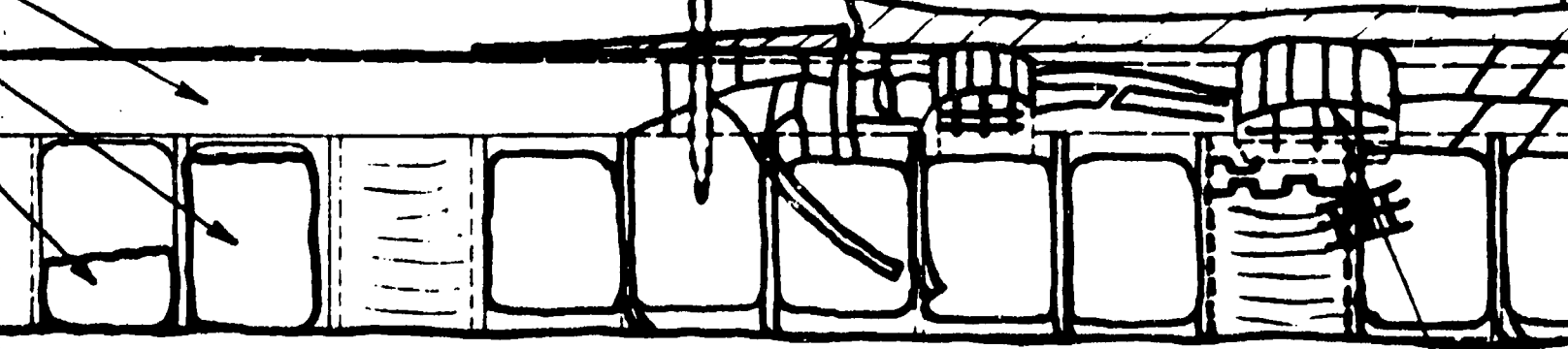

3



FRAMES 56 TO 71, 74 TO 95, 98 TO 107,
AND 110 TO 118 CARRIED AWAY IN-
BOARD BY BLAST. WOBBLE BENTS
ADJACENT TO EXPANSION JOINTS TORN
AWAY FROM CONNECTION TO HANGAR DECK.
(FRAMES 62, 65, 83, 86, 110 AND 113).

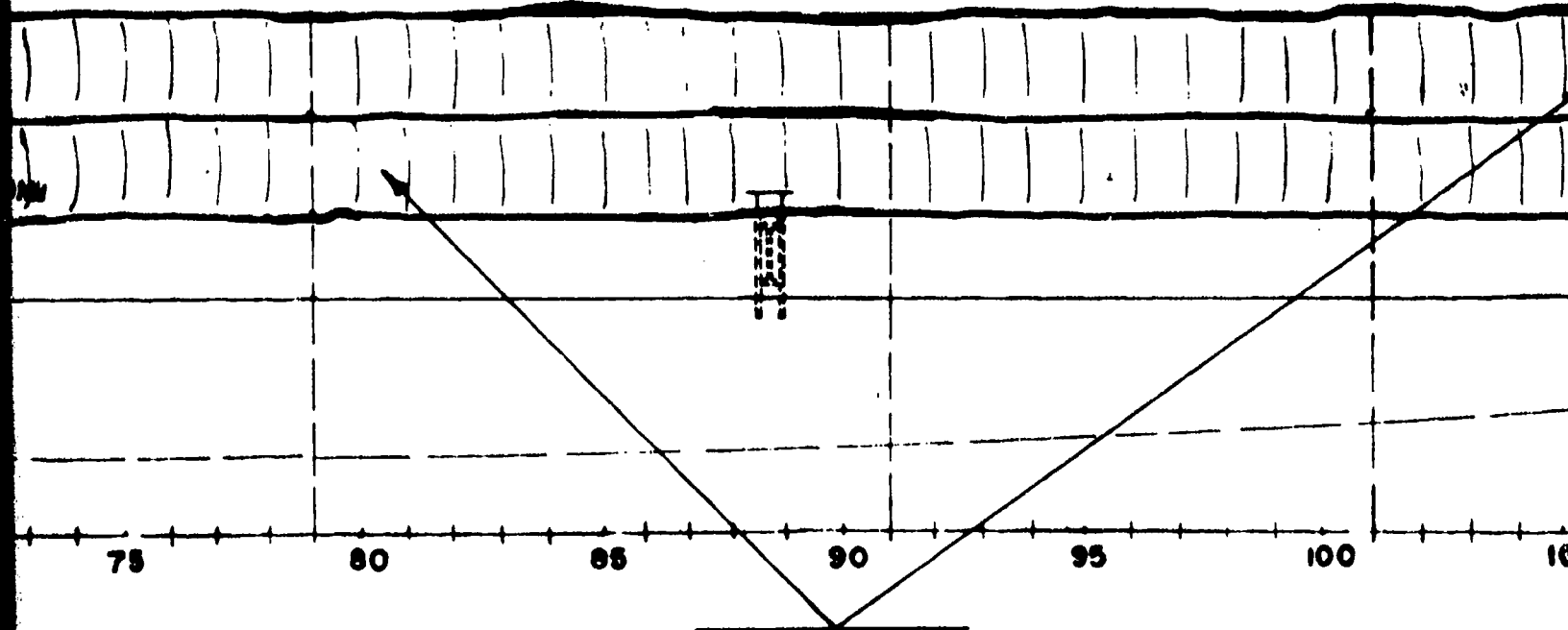
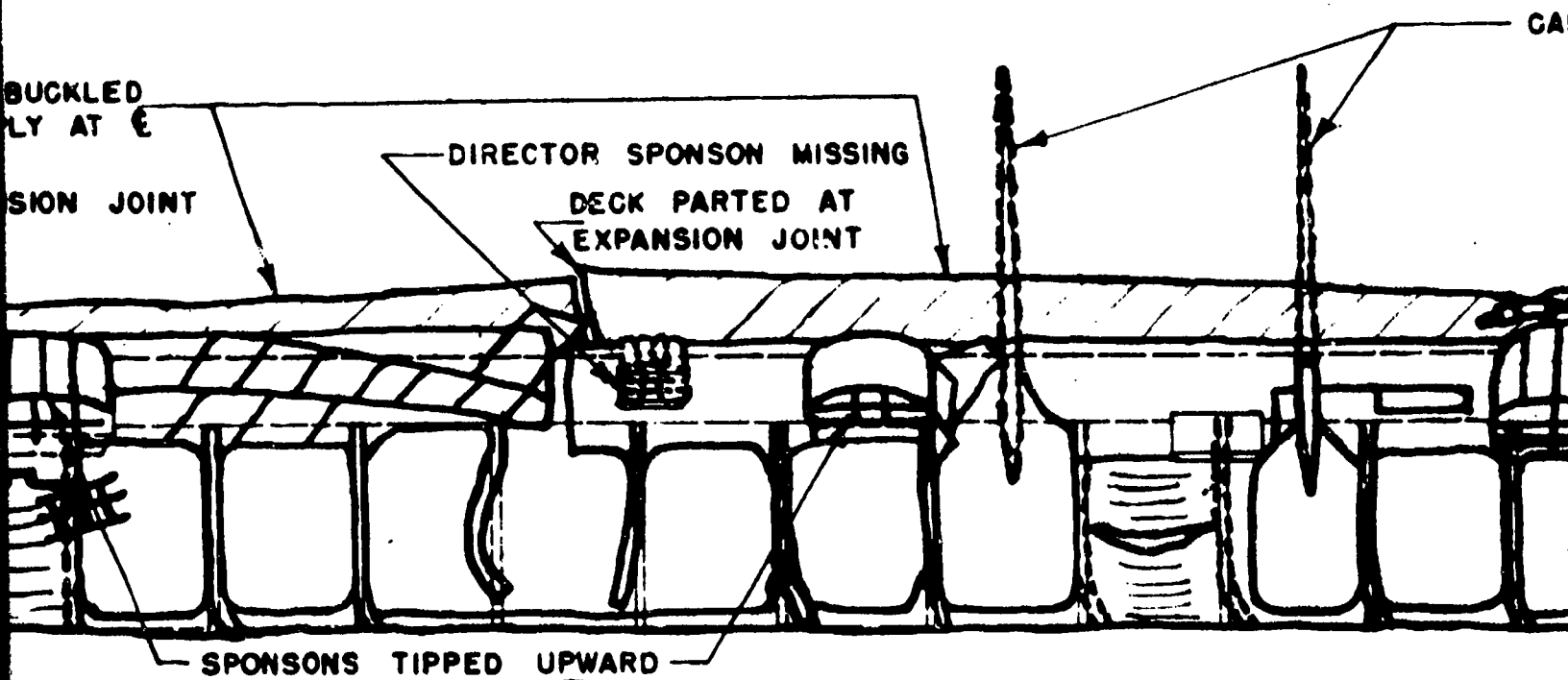

BLISTER PLATING DISHED AFT OF FRAME 45
BETWEEN LONGITUDINAL FLATS AT MAIN,
SECOND AND THIRD DECKS LEVELS.



4

ROLLER CURTAINS CARRIED AWAY TO STARBOARD BY BLAST.

CARRIED AWAY BY BLAST

BOAT HANDLING PLAT AND EQUIPMENT DEM

ROLLER CURTAIN DAMAGED BUT INTACT.

DECK PARTED AT EXPANSION JOINT

SPONSONS TIPPED UPWARD

TEAR

105 110 115 120 125 130 135

AREA BELOW THIRD DECK LINE DEEPLY DISHED BETWEEN FRAMES 126 AND 133.

MAIN DECK EXPOSED TEAR AND TURNED D

5

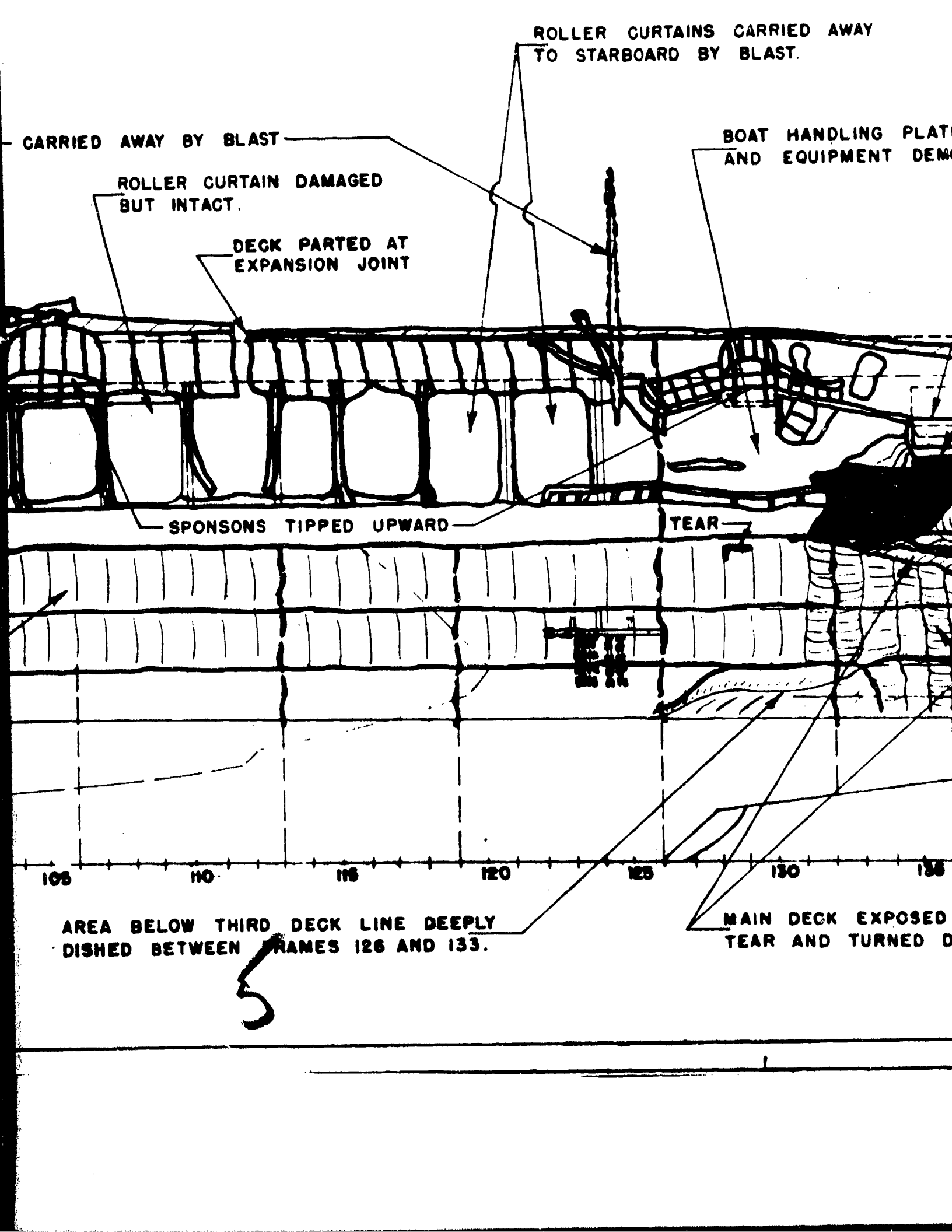

R CURTAINS CARRIED AWAY
ARBOARD BY BLAST.

BOAT HANDLING PLATFORM
AND EQUIPMENT DEMOLISHED

40MM GUN PLATFORM
TIPPED DOWN WITH
OUTBOARD BULWARK MISSING.

AFTER
FLIGHT

HOLES

GUN
BAD

TEAR

W.L. BEFORE TEST
W.L. AFTER TEST

PORT BILGE OF
HOLES

125

130

135

140

145

AP

MAIN DECK EXPOSED THROUGH
TEAR AND TURNED DOWNWARD.

AREA DEEPLY DISHED ABOVE
THIRD DECK LINE.

6

AFTER PORT CORNER OF
FLIGHT DECK BLOWN UPWARD.

GUN PLATFORM BULWARKS
BADLY DISTORTED AND TORN.

AFTER CORNER MAIN DECK
TURNED DOWNWARD.

W.L. BEFORE TEST

W.L. AFTER TEST (CHANGE DUE TO 5° STBD. LIST)

PORT BILGE OF OVERHANG UPTURNED

HOLES

AP

PLY DISHED ABOVE
CK LINE.

17

SECRET

PAGE 202 OF 280

NAVY DEPT.

BUREAU OF

DAMAGE
PORT PROFILE
TEST A

U.S.S. INDEPENDENCE

PLATE NO. 1

WOODEN DECK COVER
HEAT FROM FIRE BEL

UPWARD DEFLECTION APPARENTLY
CAUSED BY REFLECTION OF
BLAST FROM WATER.

SEAM FAILURE

W.L. AFTER TEST

W.L. BEFORE TEST

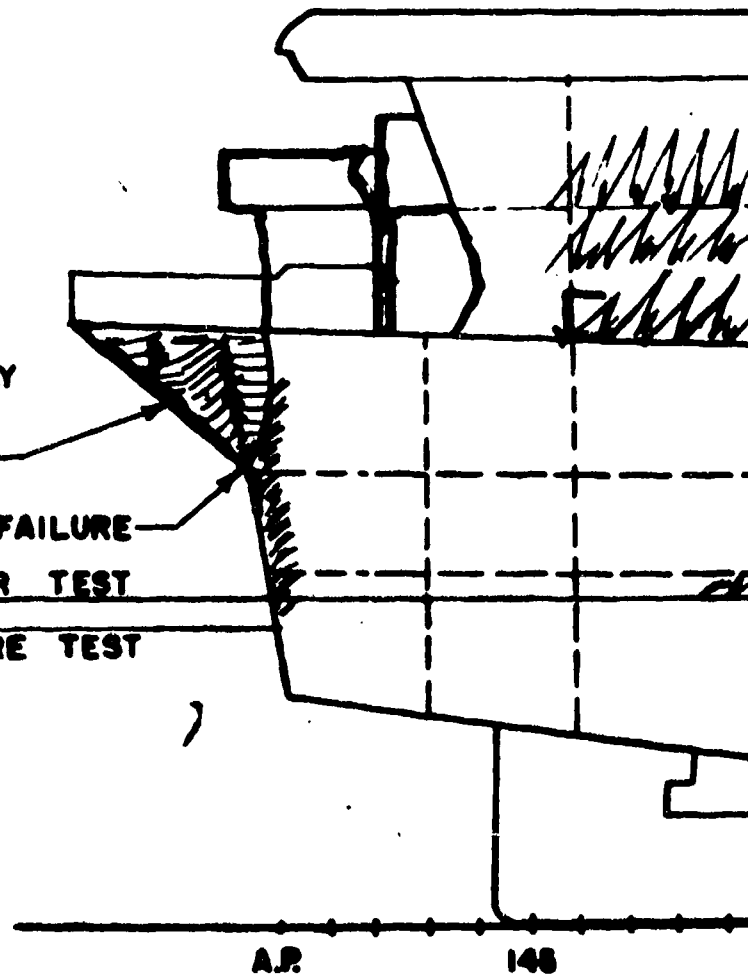

A.P.

148

COMPTS. ABOVE MAIN D
GUTTED BY FIRE. 12 TO
EXPLODED WITH LOW C

MAIN DECK COVERING IGNITED BY
FROM FIRE BELOW.

ROLLER CURTAINS BLOWN

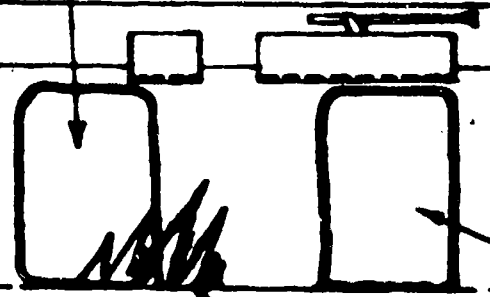
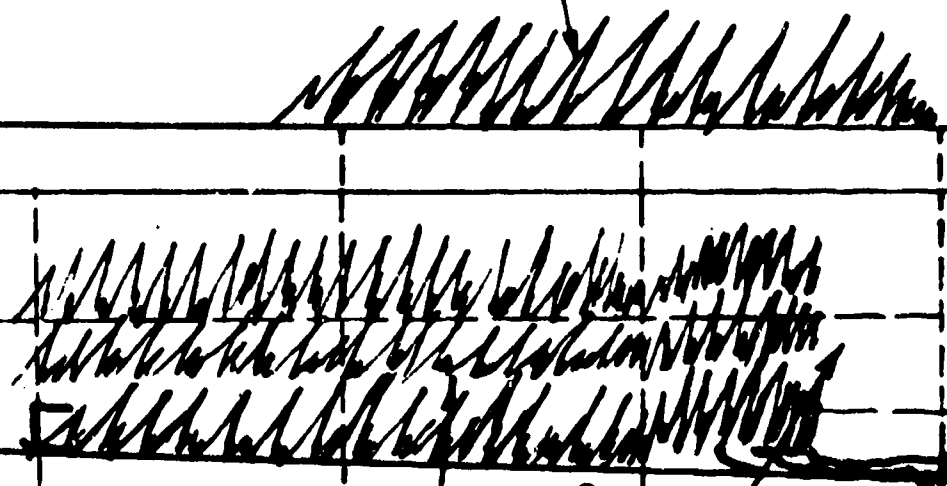

TEAR IN PLATING

SHEAR WRINKLES ALONG WATERLINE

145 140 135 130 125 120 115

ABOVE MAIN DK. AFT OF BHD. 126 ARE
BY FIRE. 12 TORPEDOES BURNED OR
WITH LOW ORDER DETONATIONS.

2

STACKS ARE CRUSHED AND TORN

RAILS BLOWN AWAY

VENT SCREENS BLOWN OUT

WATER BURNED

HANGER DECK

PANELS BLOWN OUT

WATERLINE

115

110

105

100

95

90

85

3

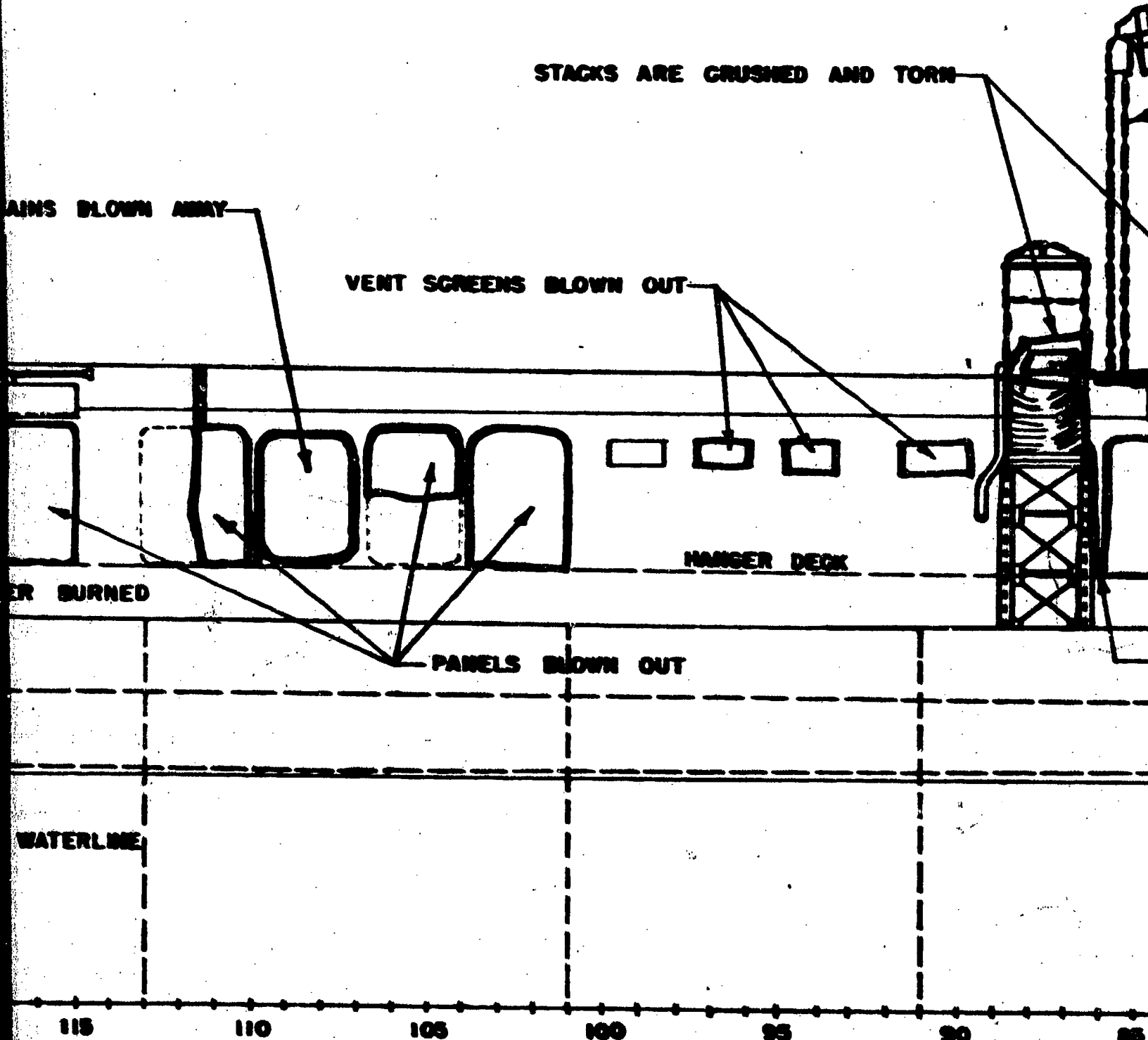

CARRIED AWAY BY BLAST

STACKS ARE BLOWN TO STBD,
CRUSHED, AND TORN.

VENT SCREEN
BLOWN OUT.

DOOR BLOWN OFF

TEAR IN WAY OF VENT OPENING

BENTS AT FRAMES 88, 85, AND 82 TORN AWAY FROM
DECK AND PANELS BLOWN OUT OR TORN.

ROLLER
BLOWN

SECTION OF CATWALK
DECK BLOWN DOWN.

88 80 75 70 65 60 55

⊗

4

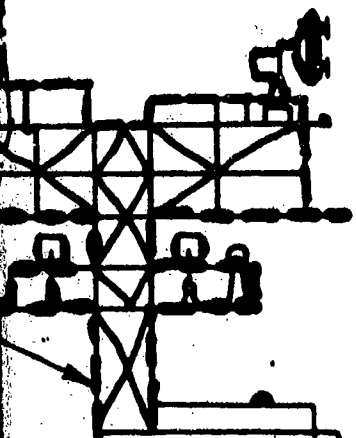

DEFLECTED SLIGHTLY TO STBD.

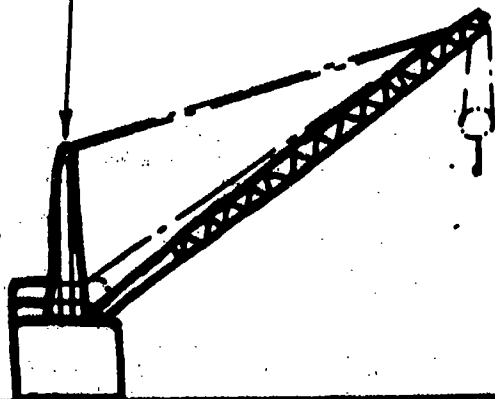

CARP

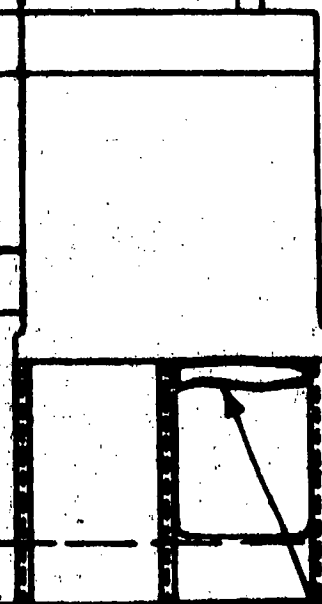

ROLLER CURTAINS
BLOWN AWAY

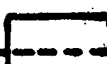
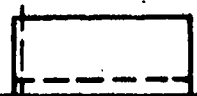
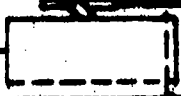

55

50

45

40

35

30

5

CARRIED AWAY BY BLAST

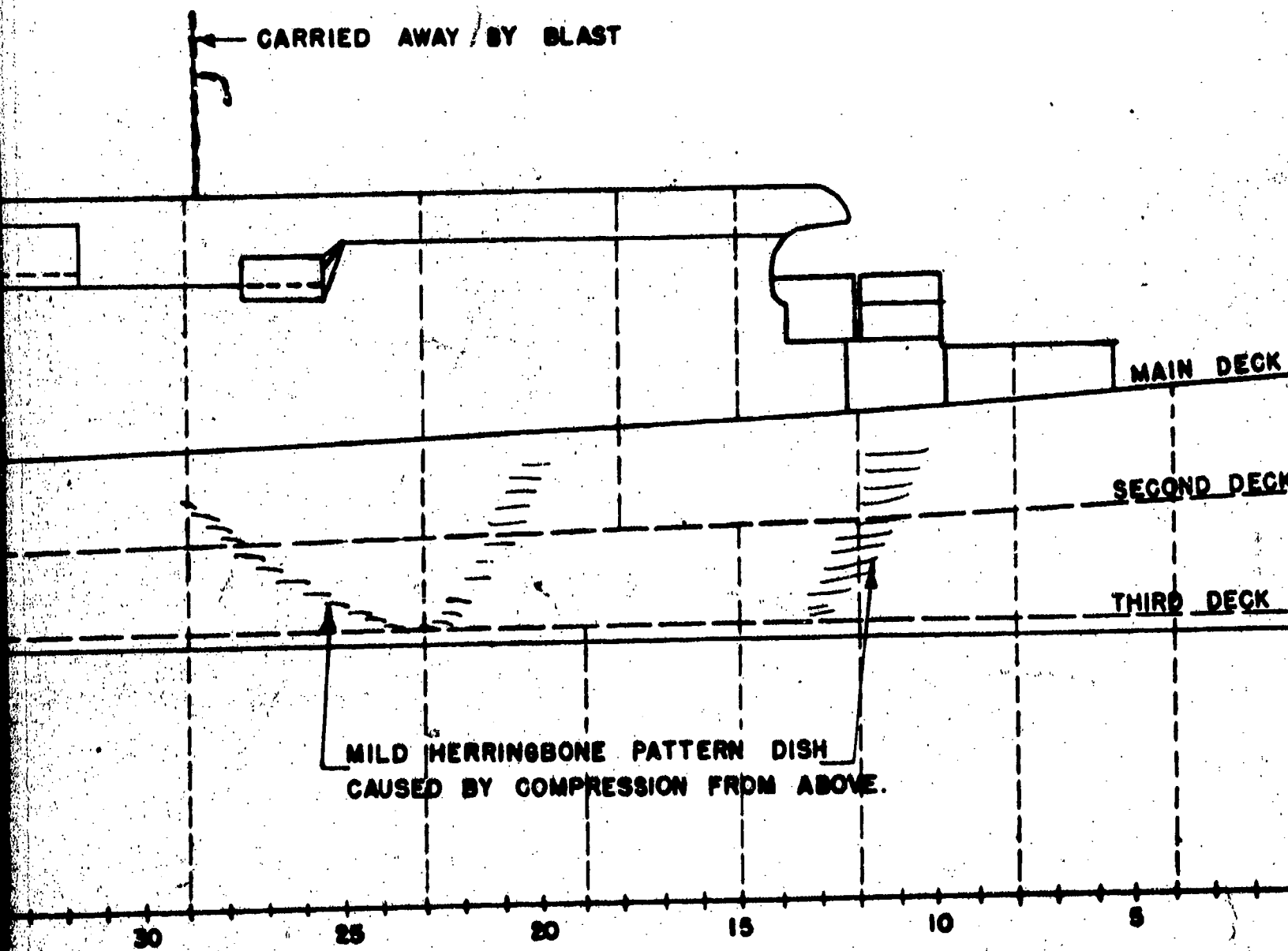

MAIN DECK

SECOND DECK

THIRD DECK

MILD HERRINGBONE PATTERN DISH
CAUSED BY COMPRESSION FROM ABOVE.

30

25

20

15

10

5

6

LEGEND



FIRE

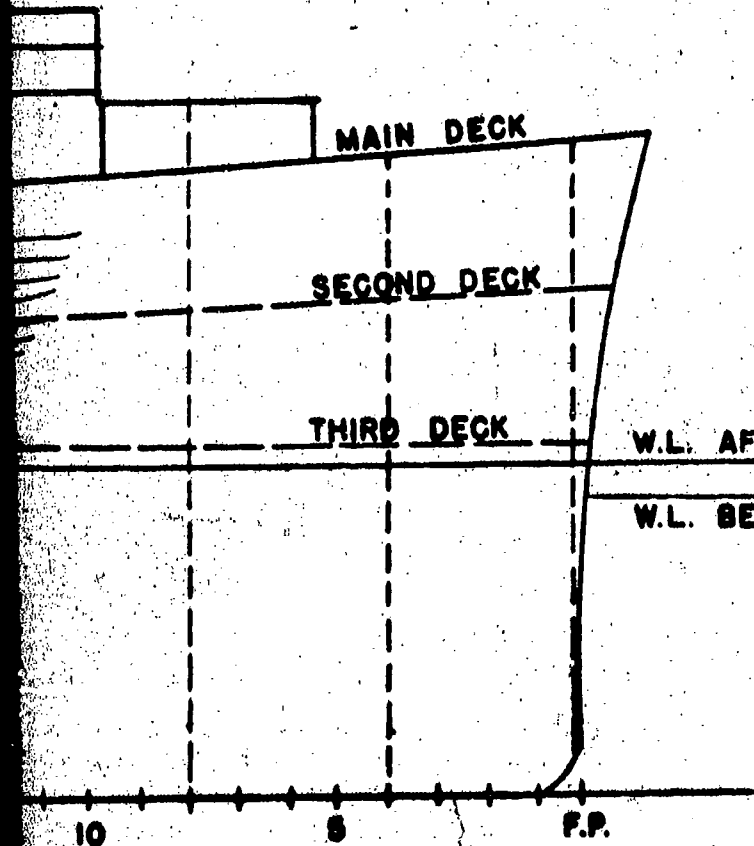

W.L. AFTER TEST DUE TO 5° STBD. LIST.

W.L. BEFORE TEST

SECRET

PAGE 203 OF 280

NAVY DEPT.

BUREAU OF S

DAMAGE
STARBOARD PROFILE
TEST A

U.S.S. INDEPENDENCE

CVL

9

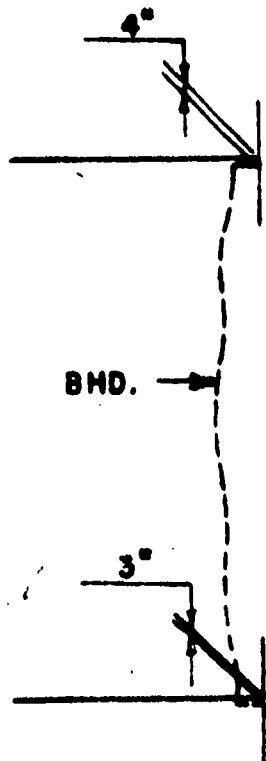

BHD.

AFT ELEVATOR OPENING

3°

125

120

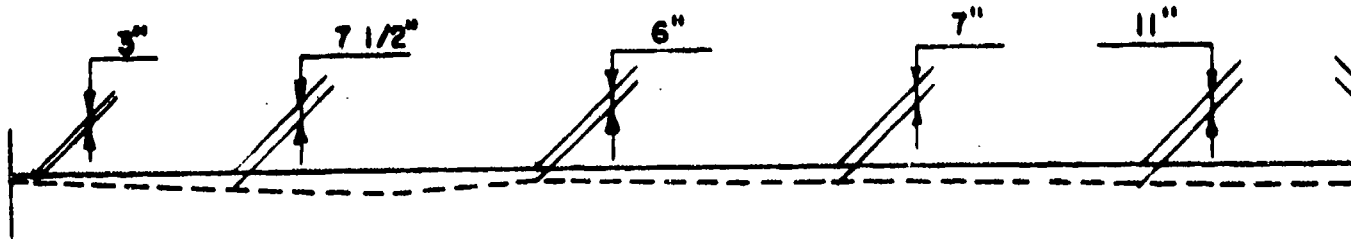
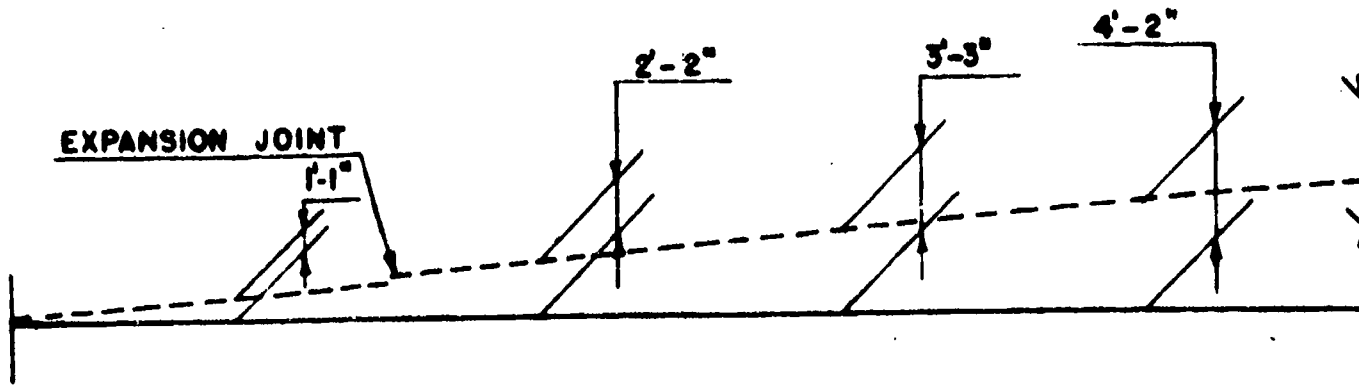

115

110

105

2

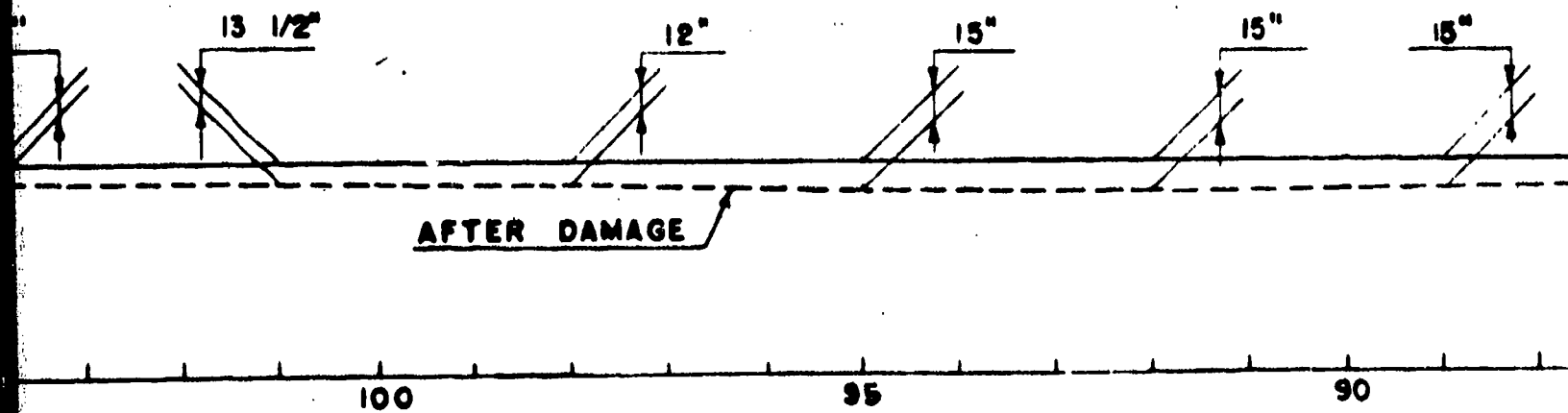
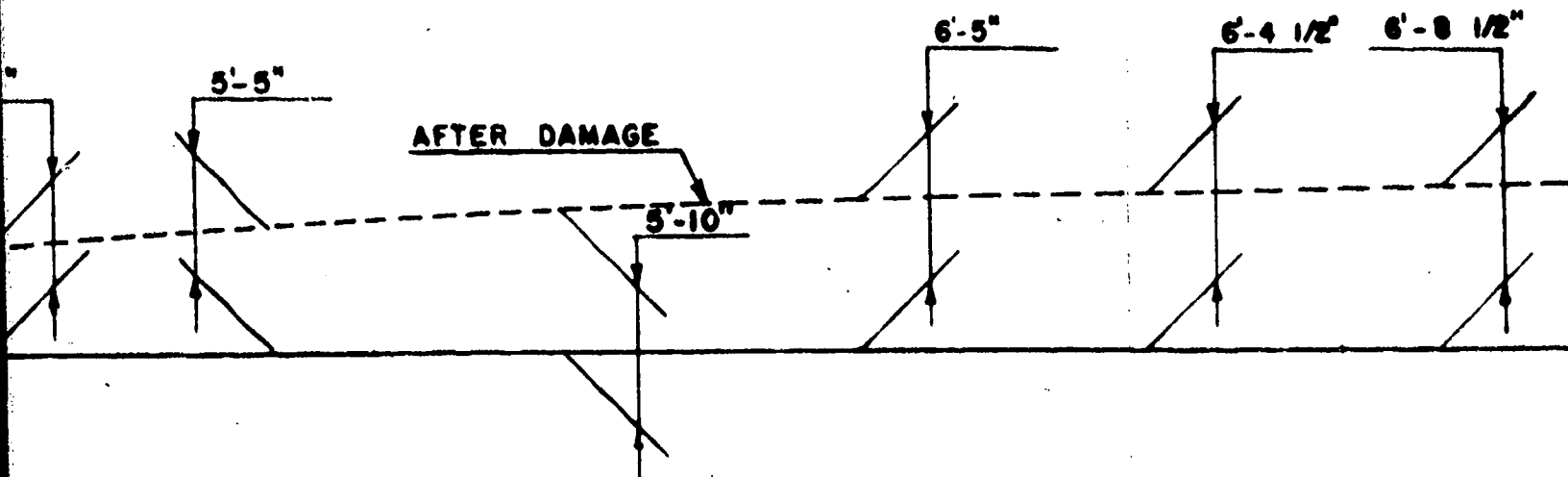

3

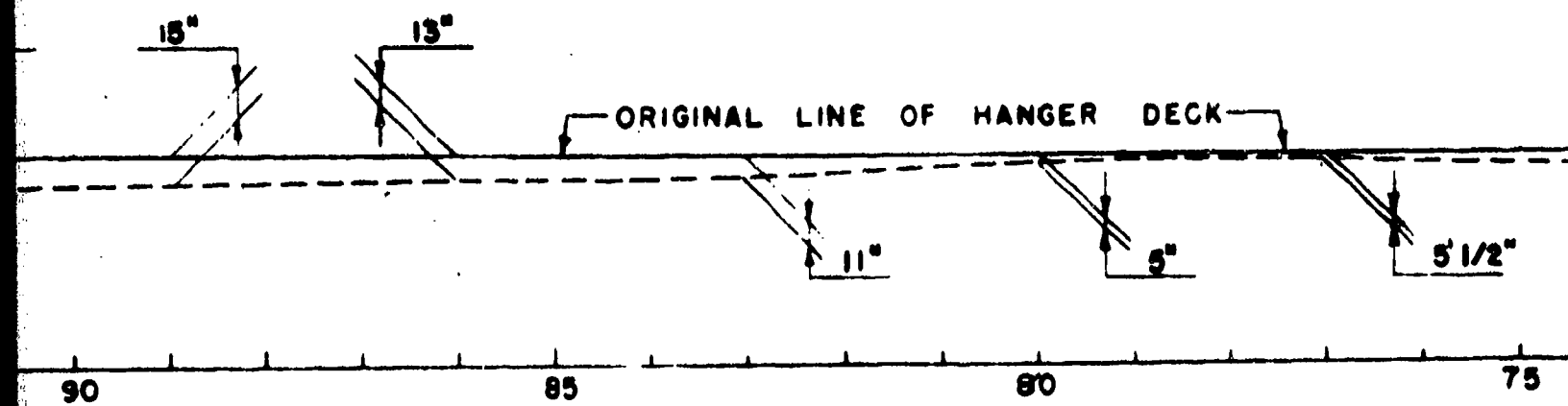
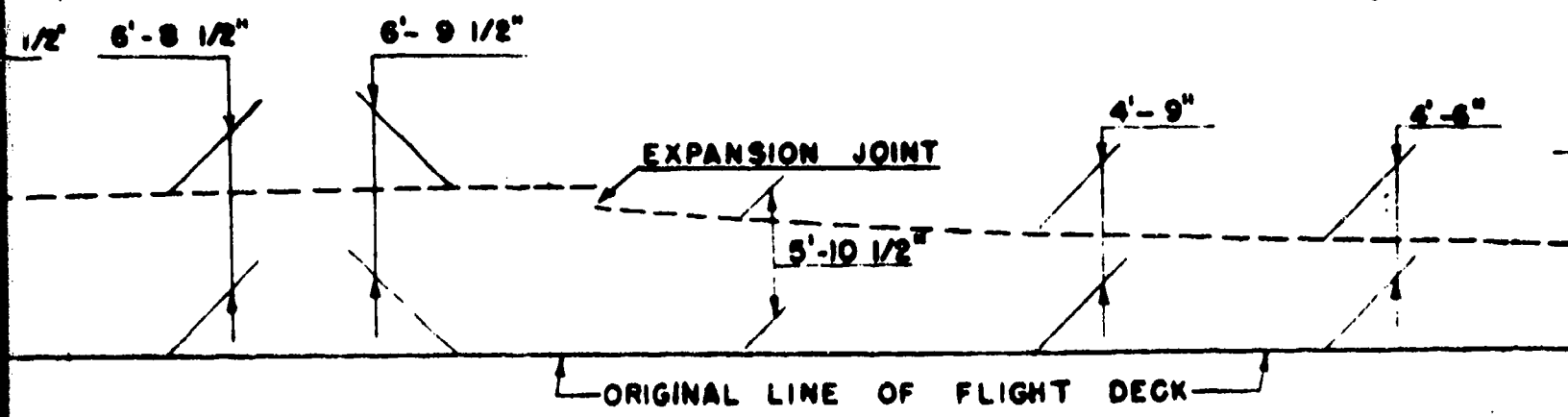

90 85 80 75

ELEVATION
 FLIGHT DECK & HANGER DECK CENTER

SCALE - 1/8" = 1'-0"

4

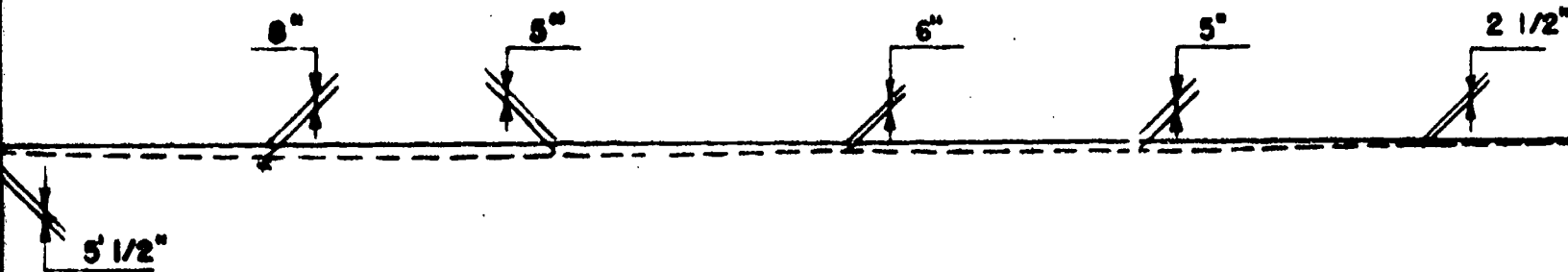
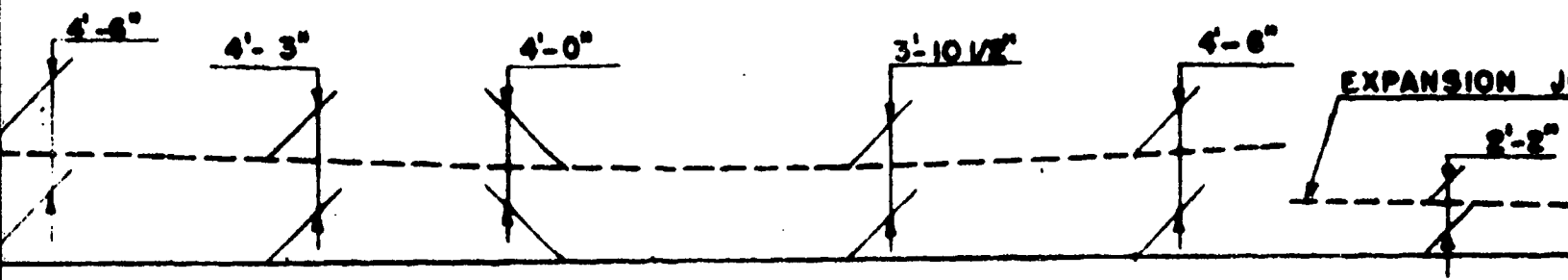

75

70

65

CENTERLINE PROFILE

0"

6

VISION JOINT

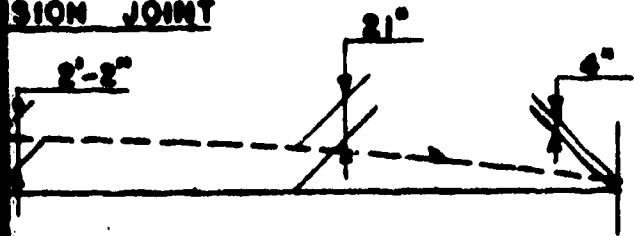

FORD. ELEVATOR OPENING

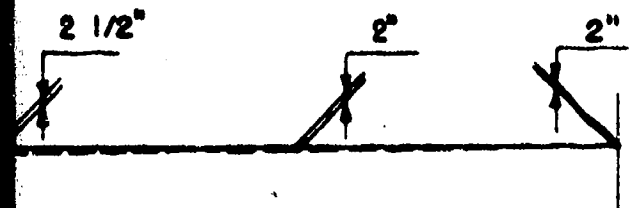

60

55

50

6

FORWARD

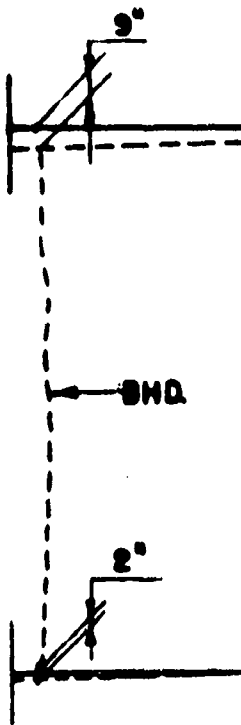

FLIGHT DECK

R OPENING

BHD

50

45

40

35

ORIGINAL DECK LINE _____

AFTER DAMAGE LINE - - - - -

7

DECK

35

30

25

SECRET

PAGE 204 OF 280

NAVY DEPT.

BUREAU OF S

4

FLIGHT & HANGER DE
DEFLECTIONS AT CENTERL

TEST A

U.S.S. INDEPENDENCE

CVL

PLATE NO. 3

APT OF FRAME 137 MISSING FROM
DECK EDGE 18 FEET INBOARD.

115 113 111
REMNANT OF DECK BEAM AT FR.140
BENT SHARPLY UPWARD.

ORIGINAL LINE OF
FLIGHT DECK.

PORTION OF DECK TORN
AND BENT UPWARD.

AFTER PORT CORNER
OF FLIGHT DECK BLOWN
SHARPLY UPWARD TO
NEARLY VERTICAL POSITION.

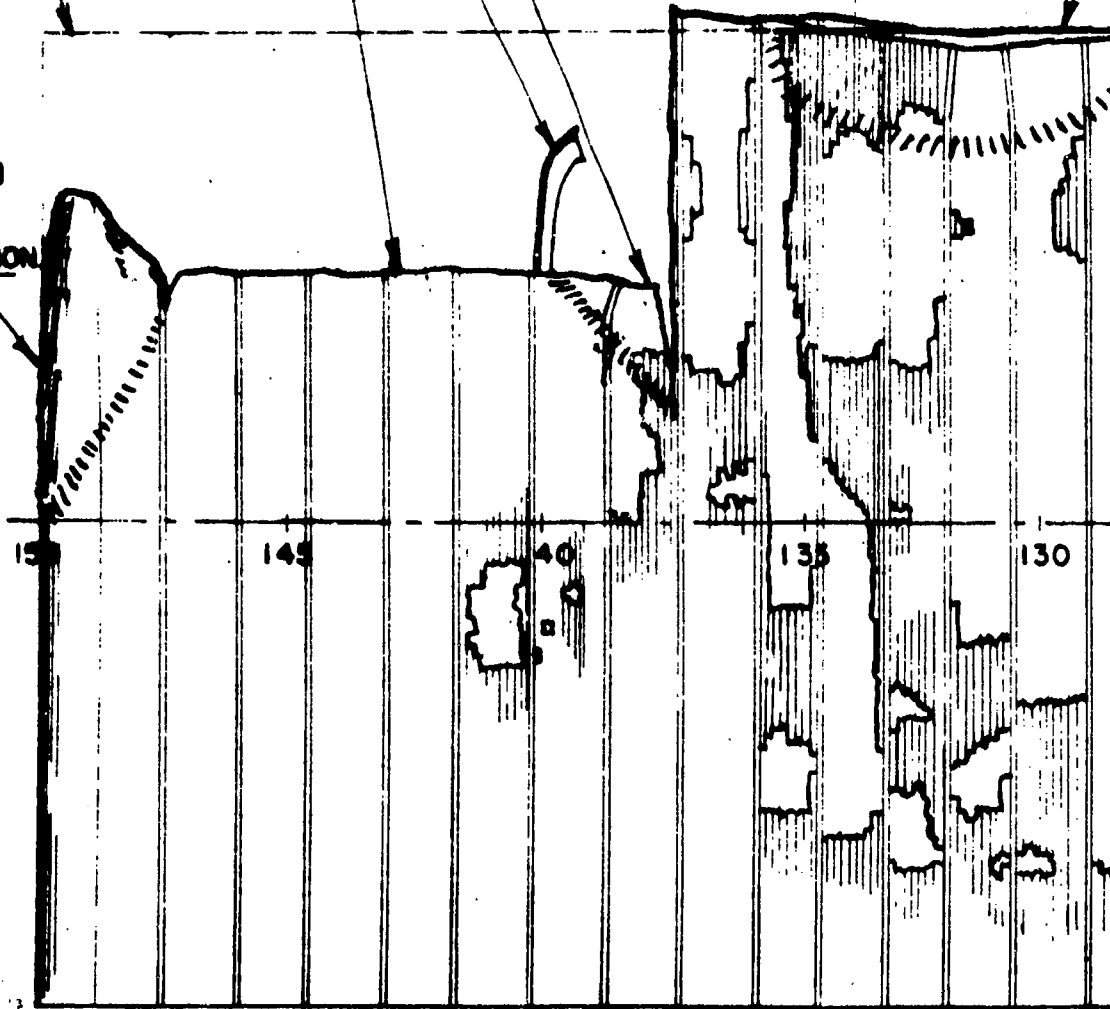

FLIGHT DECK BADLY WARPED AND
WOOD DECKING BURNED FROM
BELOW.

115 113

DECK EDGE BLOWN UPWARD

EXPANSION JOINT FLEXED AND DISTORTED.

5 LB. PLATING TORN ACROSS RAISED PORTION OF DECK BETWEEN FRAMES 95 AND 96. SEE PHOTO. PAGES 201 AND 202

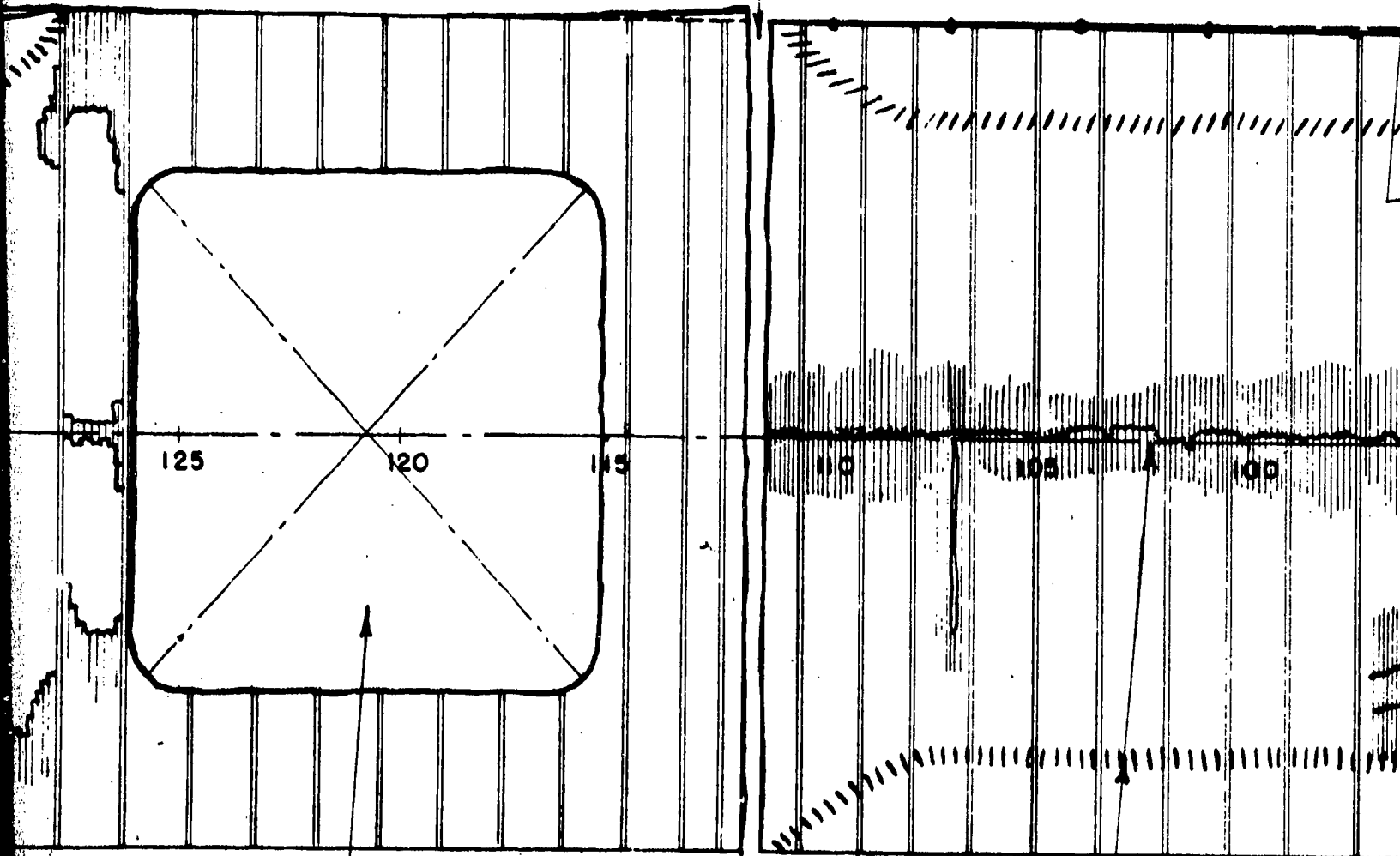

ELEVATOR MISSING

EXPANSION AND SPR

FLIGHT DECK BLOWN UP SHARPLY ABOUT NINE FEET INBOARD OF DECK EDGE, BREAKING AT CENTERLINE.

110

107

104

101

98

2

95

92

89

86

84 1/2

83

ELEVATION - PORT DECK EDGE

RAISED FRAMES

5 LB. DECK TORN SEE PHOTO. PA

D 202

6"

15"

12"

6"

14"

10"

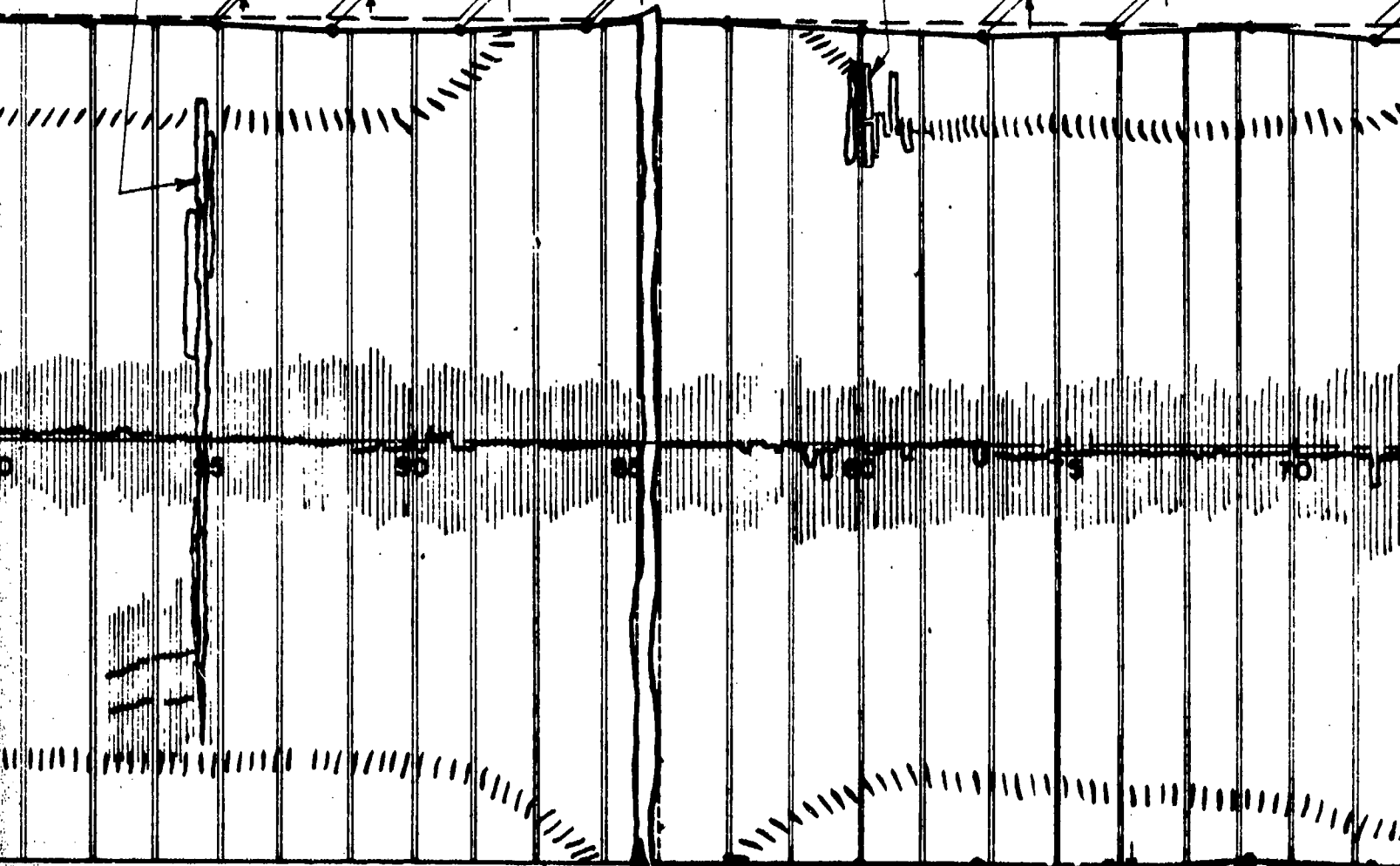

EXPANSION JOINT DISTORTED AND SPREAD APART.

PLAN VIEW

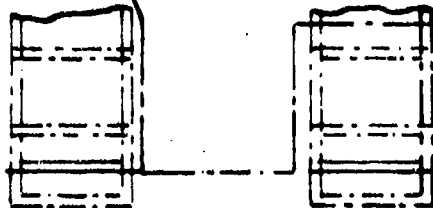

95

92

89

86

83

3

ELEVATION - STBD. DECK EDGE

7"

80

77

74

71

68

SEE PHOTO. PAGE 195

PORT EDGE OF FLIGHT DECK LIFTED FOUR FEET
IN WAY OF EXPANSION JOINT.
EXPANSION JOINT PULLED APART.

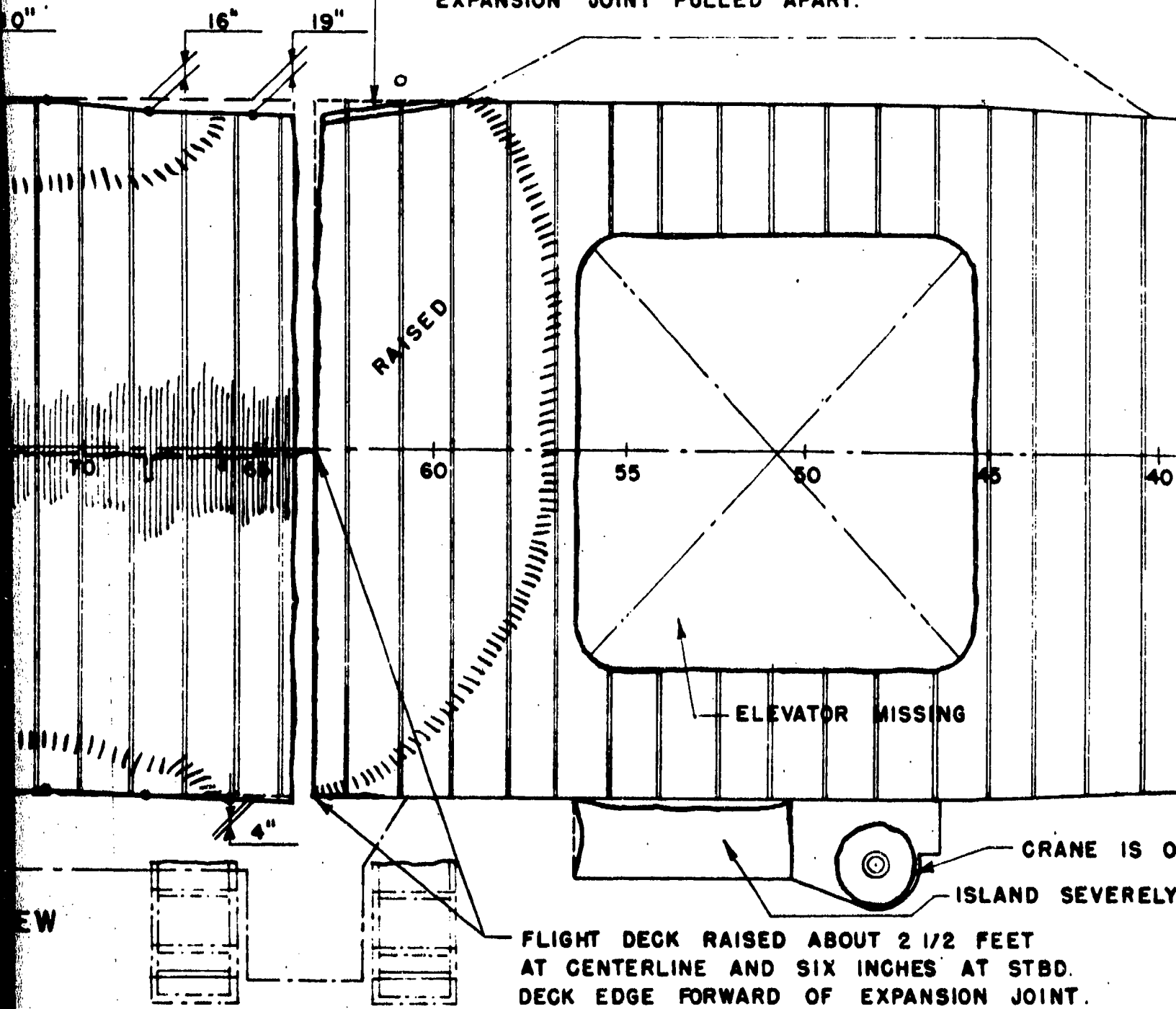

K

ED FOUR FEET

65 65 1/2 62 59
FLIGHT DECK ABREAST AND FORWARD OF FORWARD ELEVATOR IS SLIGHTLY DISTORTED BUT ESSENTIALLY UNDAMAGED.

SEE P
FLIGHT

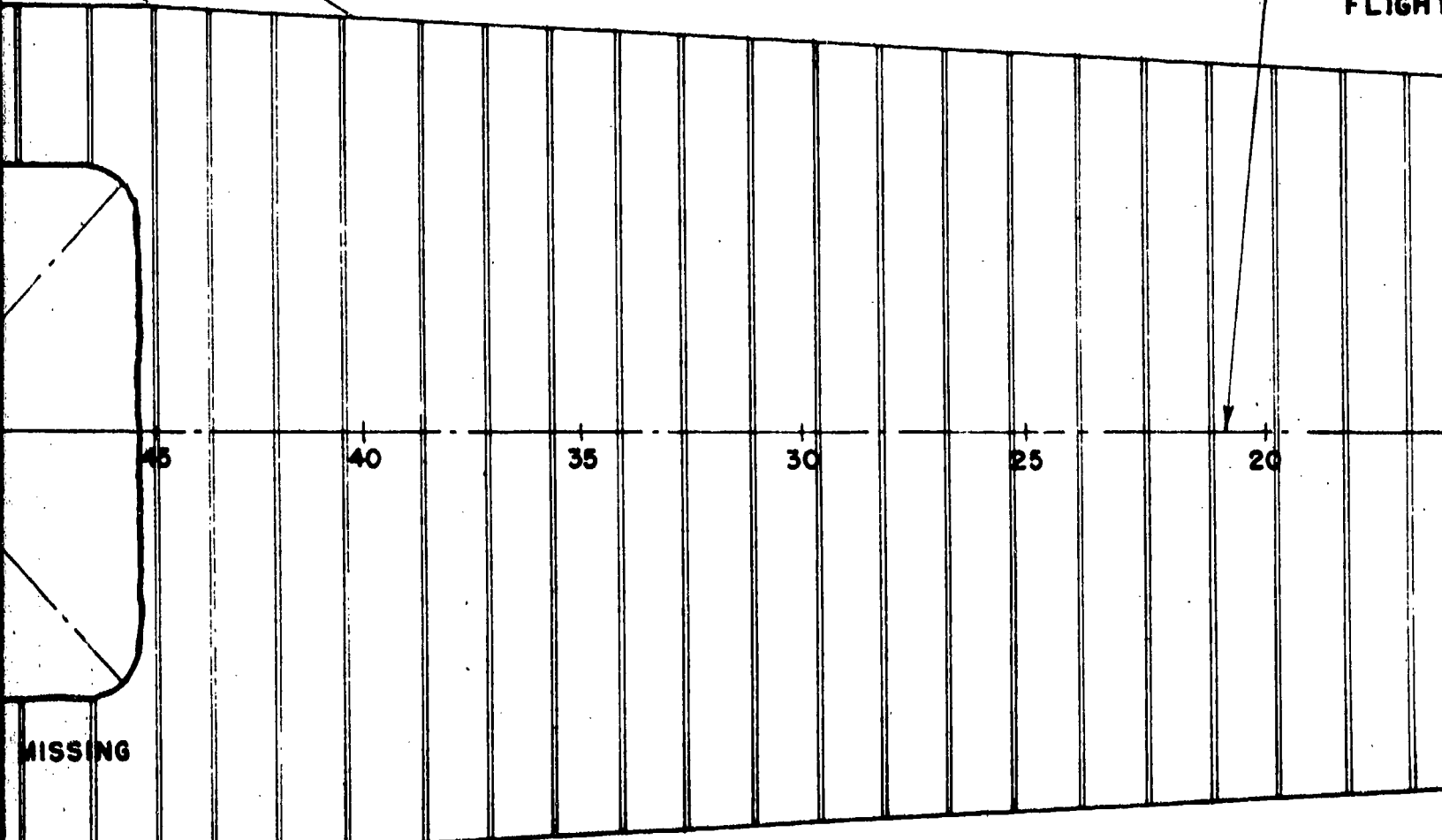

CRANE IS OFF ROLLER PATH

ISLAND SEVERELY DAMAGED AND TOP-HAMPER MISSING

AT 2 1/2 FEET
INCHES AT STBD.
EXPANSION JOINT.

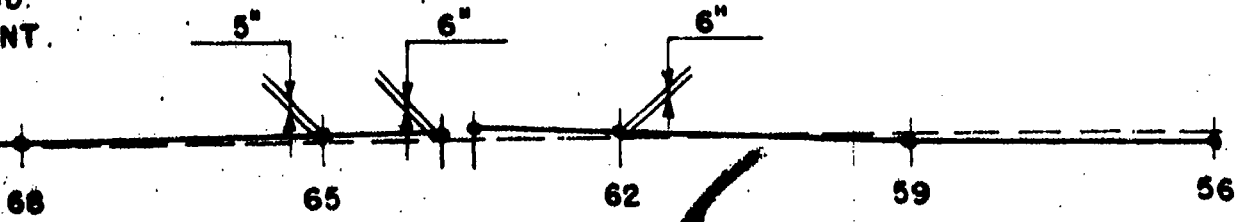

D FORWARD OF FORWARD
STORTED BUT ESSENTIALLY

SEE PLATE NO.3 FOR ELEVATION OF
FLIGHT DECK AT CENTERLINE.

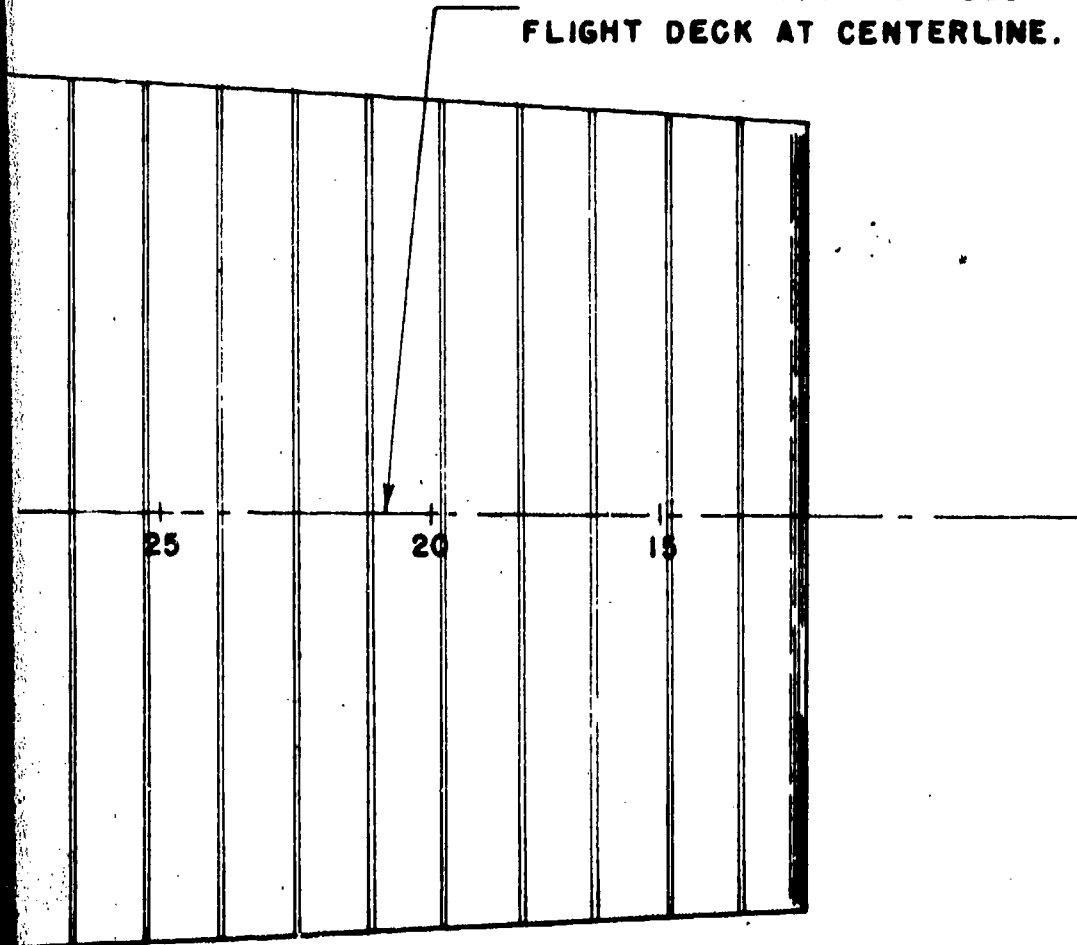

ING

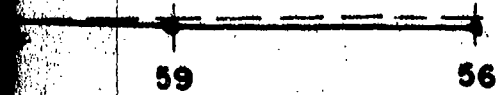

b

SECRET

PAGE 205 OF 280

NAVY DEPT.

BUREAU OF

FLIGHT DECK DAMAGE

TEST A

U.S.S. INDEPENDENCE

CV

PLATE NO. 4

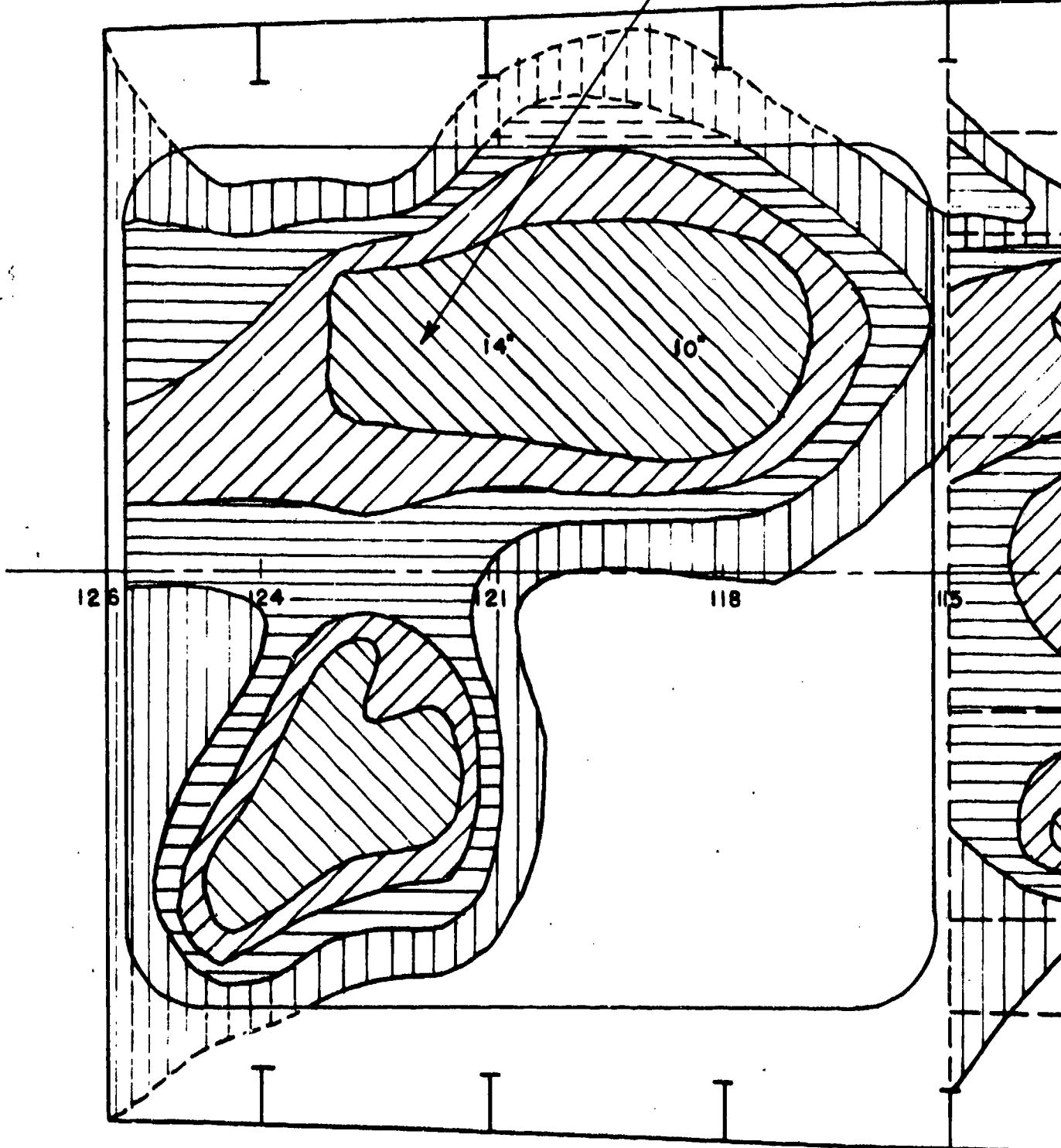

ELEVATOR PIT AT MAIN
DECK LEVEL

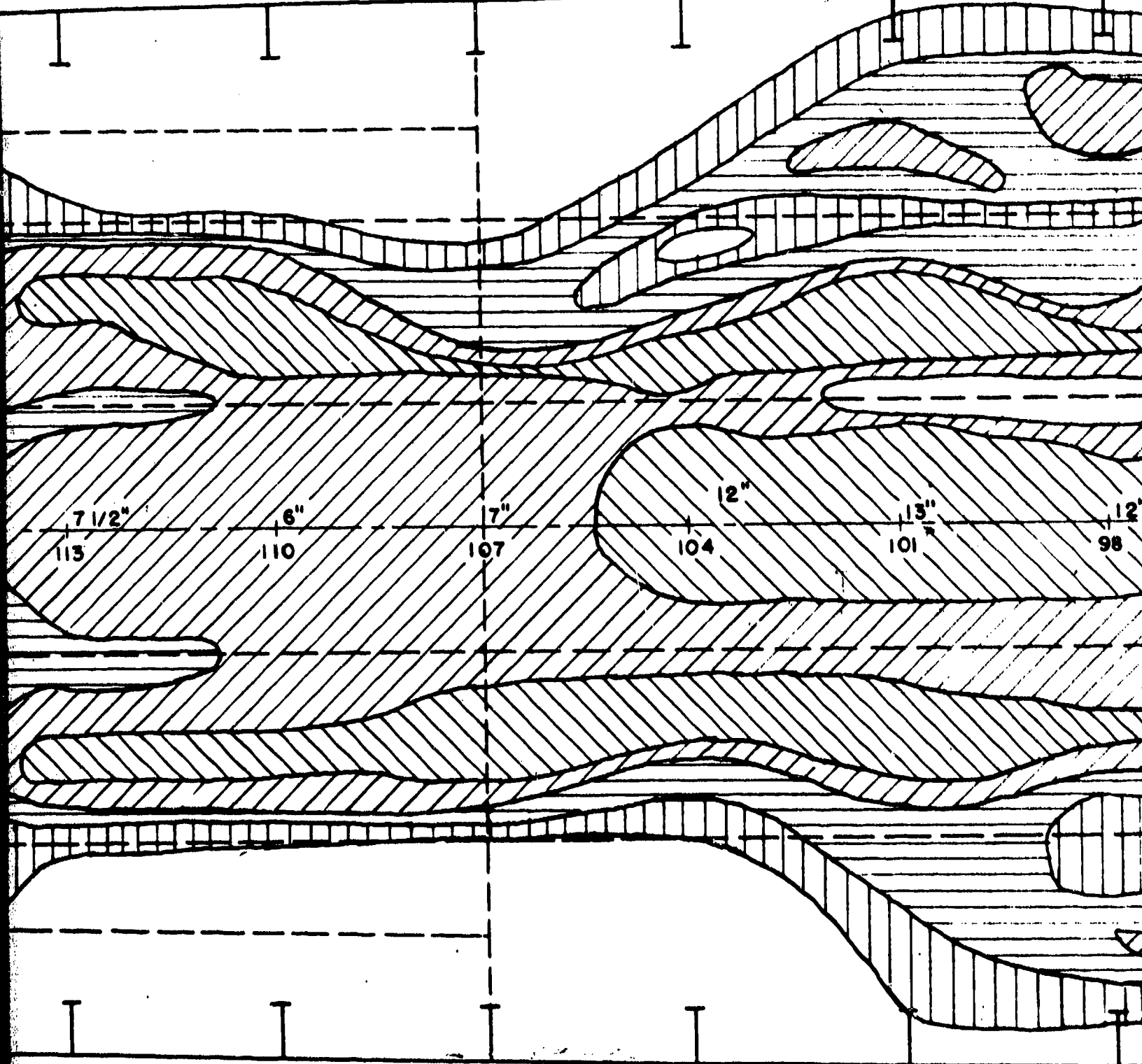

HANGER DECK LEVEL

2

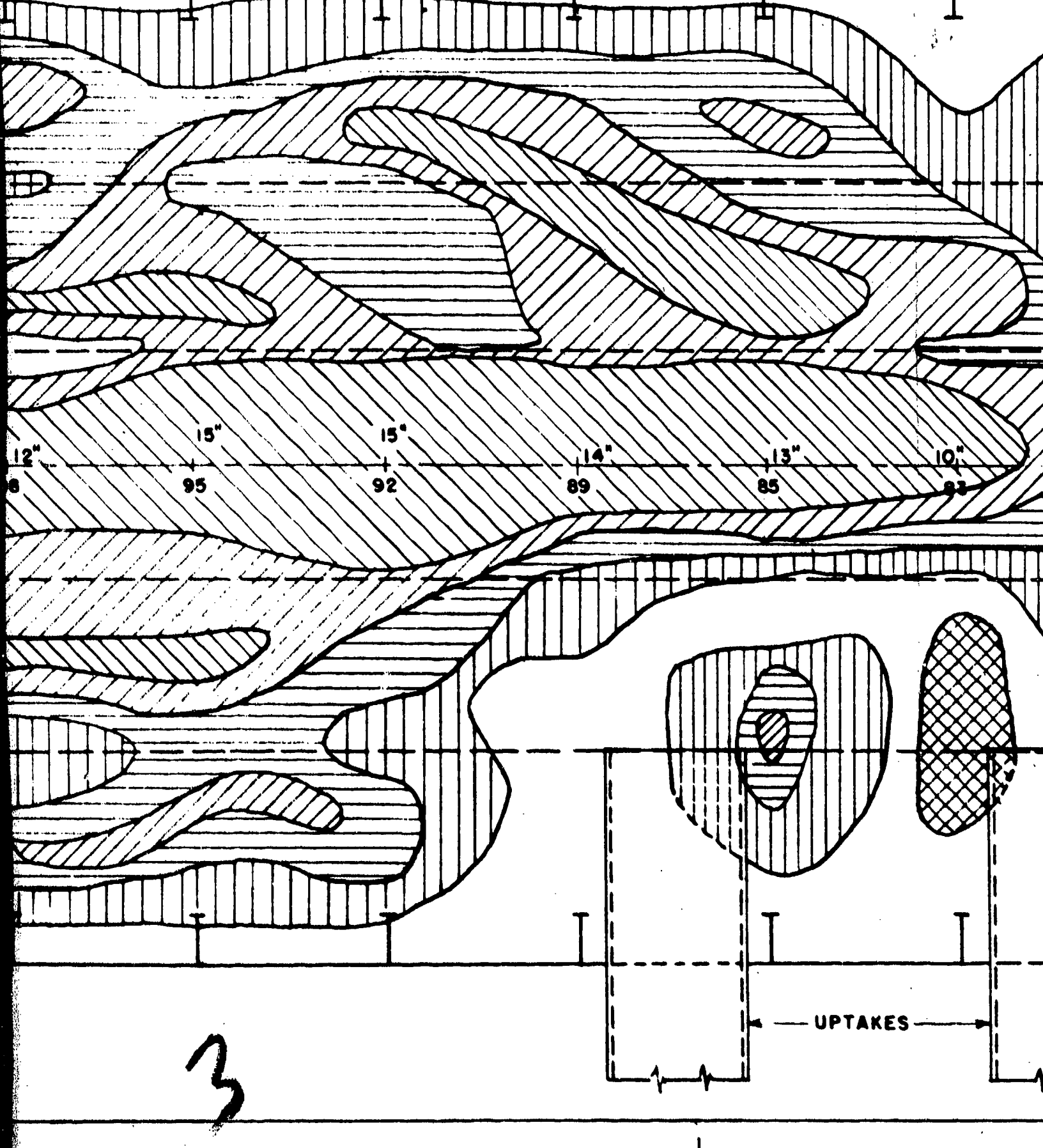

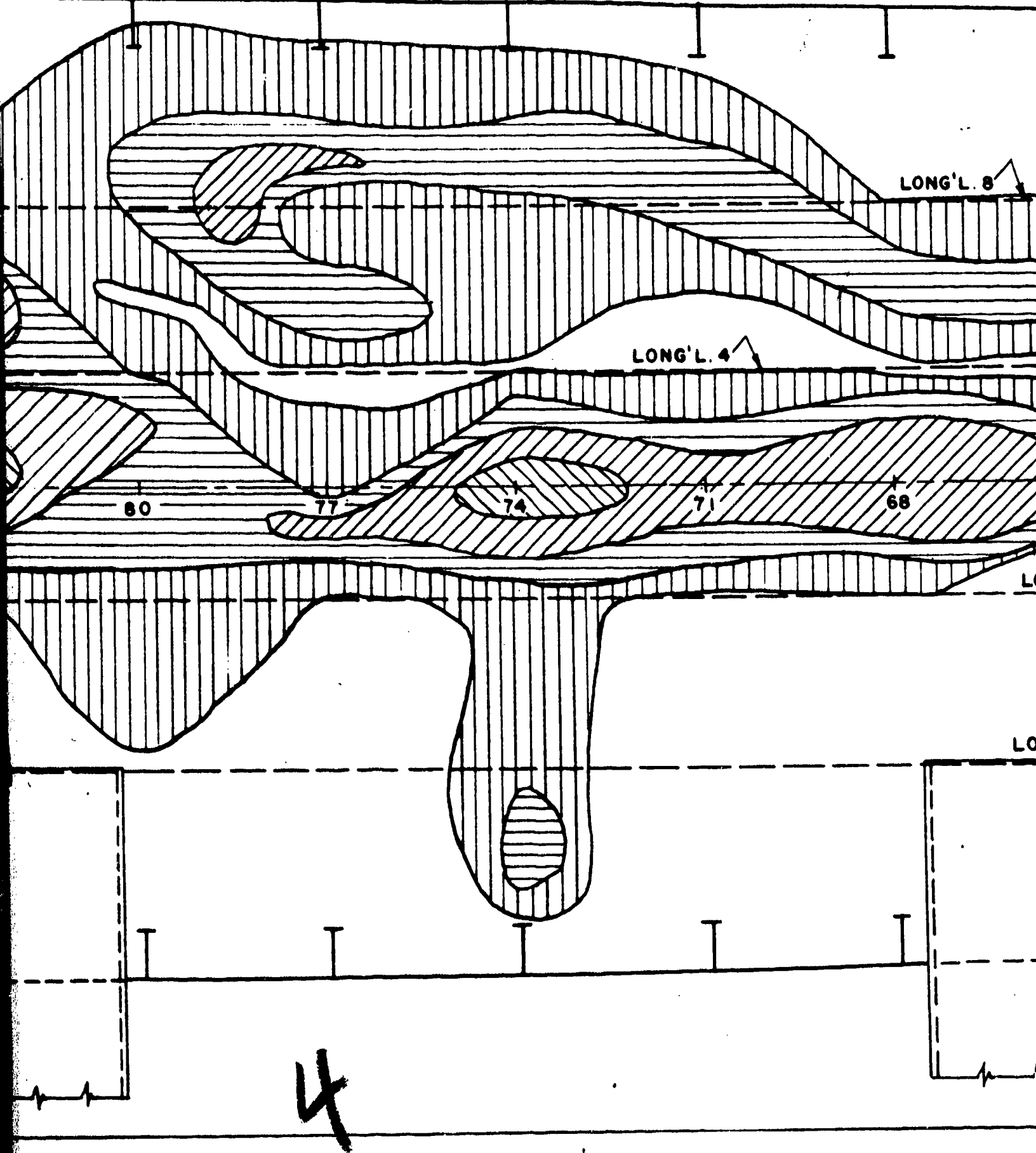

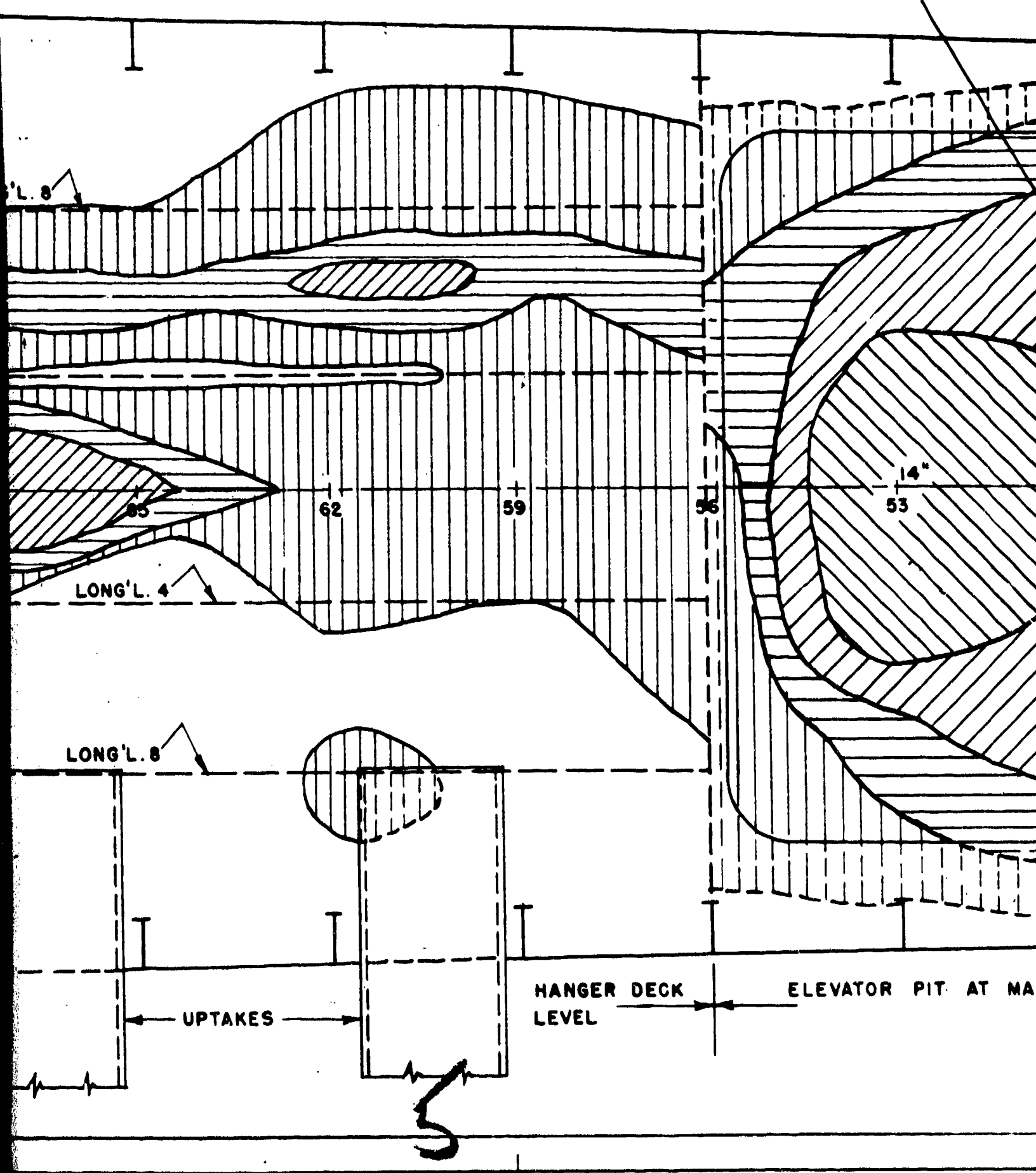

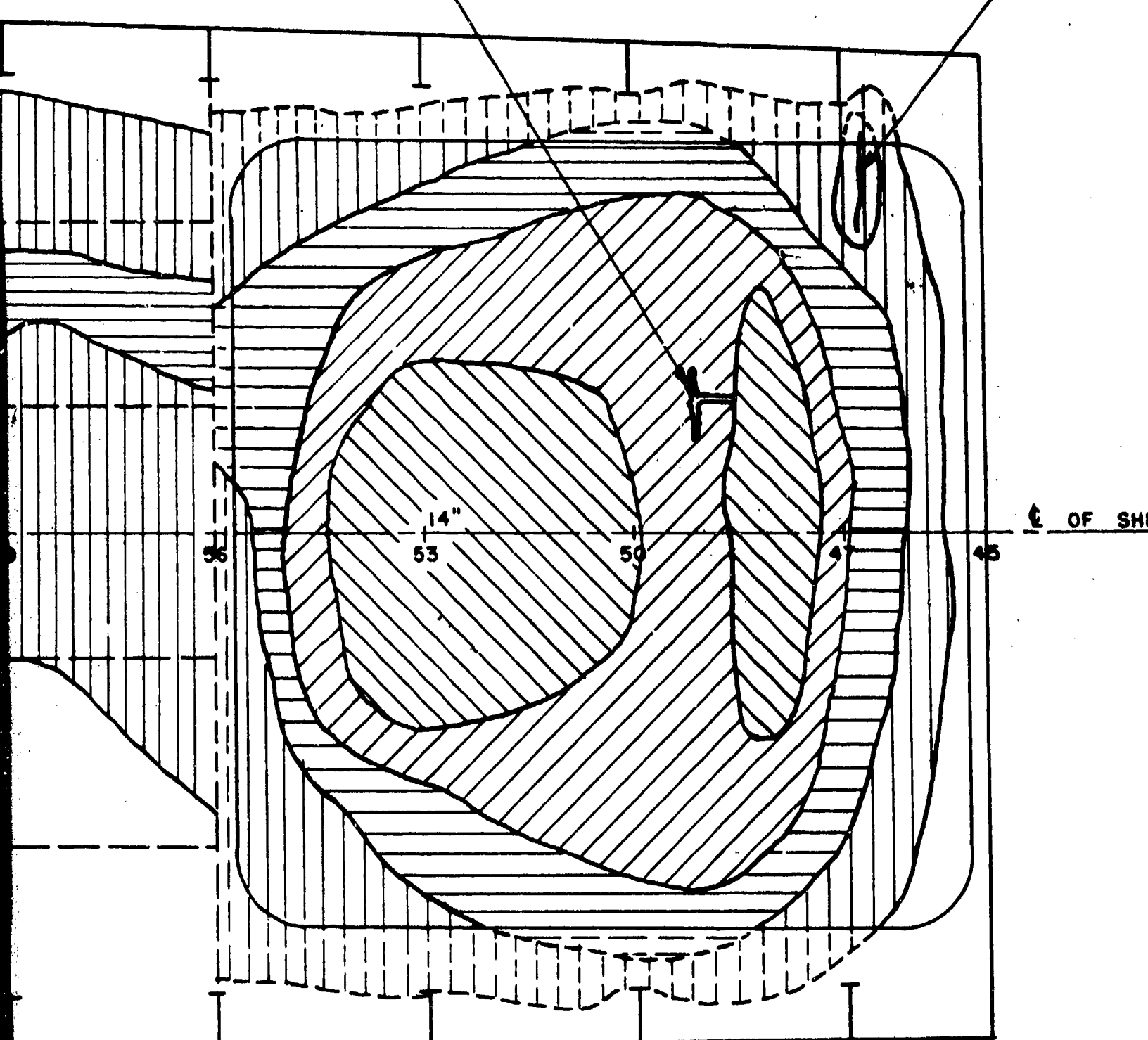

HANGER DECK
LEVEL

ELEVATOR PIT AT MAIN DECK LEVEL

6

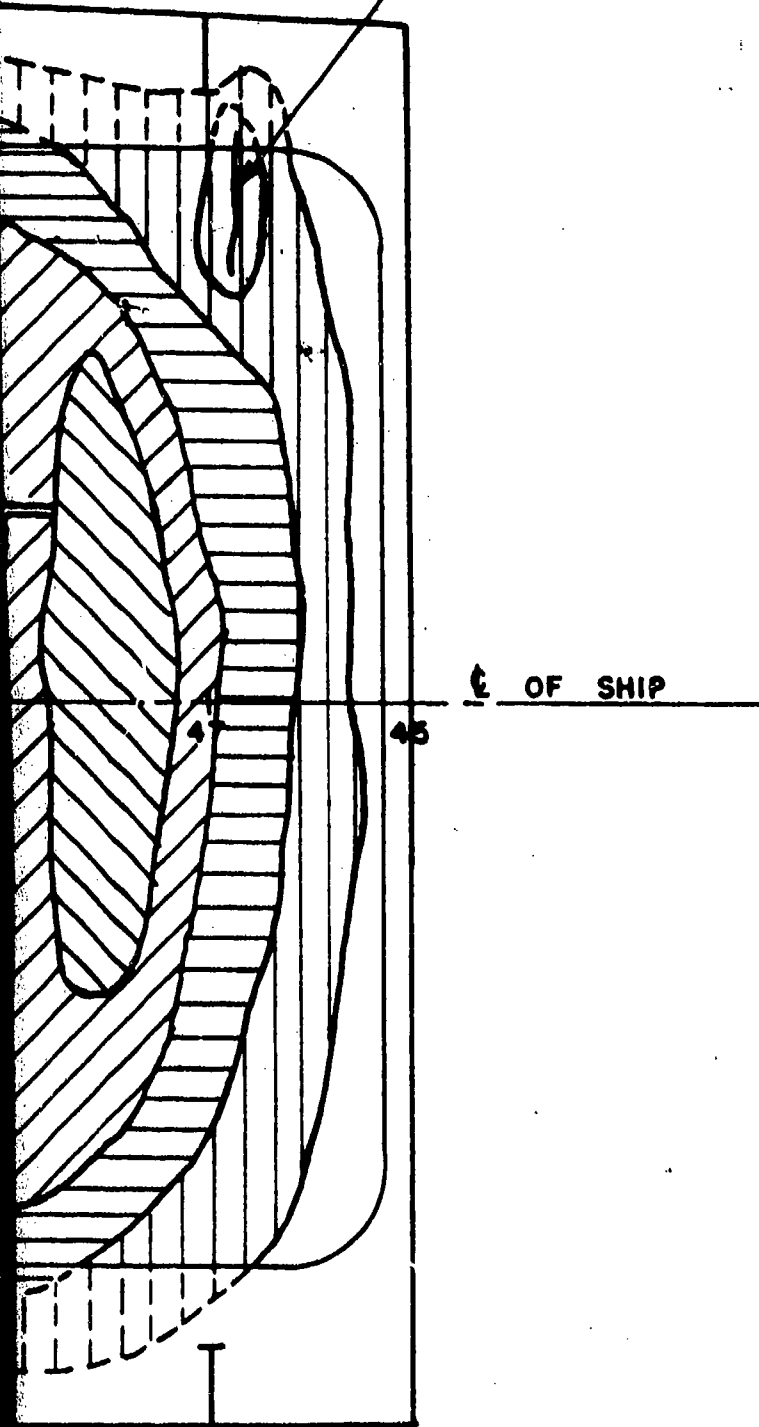

RAISED

DEGREE OF DEPRESSION



0" - 3" DEPRESSION

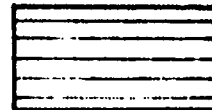

3" - 5" DEPRESSION

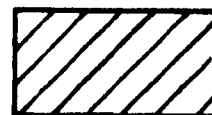

5" - 8" DEPRESSION



8" - 15" DEPRESSION



LEVEL

DIMENSIONS ASSOCIATED WITH FRAME NUMBERS INDICATE DEFLECTION AT CENTERLINE.

SECRET

PAGE 206 OF 280

NAVY DEPT.

BUREAU OF S

CONTOUR OUTLINES OF
HANGER DK. DEPRESSION

TEST A

U.S.S. INDEPENDENCE

CVL

PLATE NO. 4 A

LEVEL

6

FLIGHT DECK

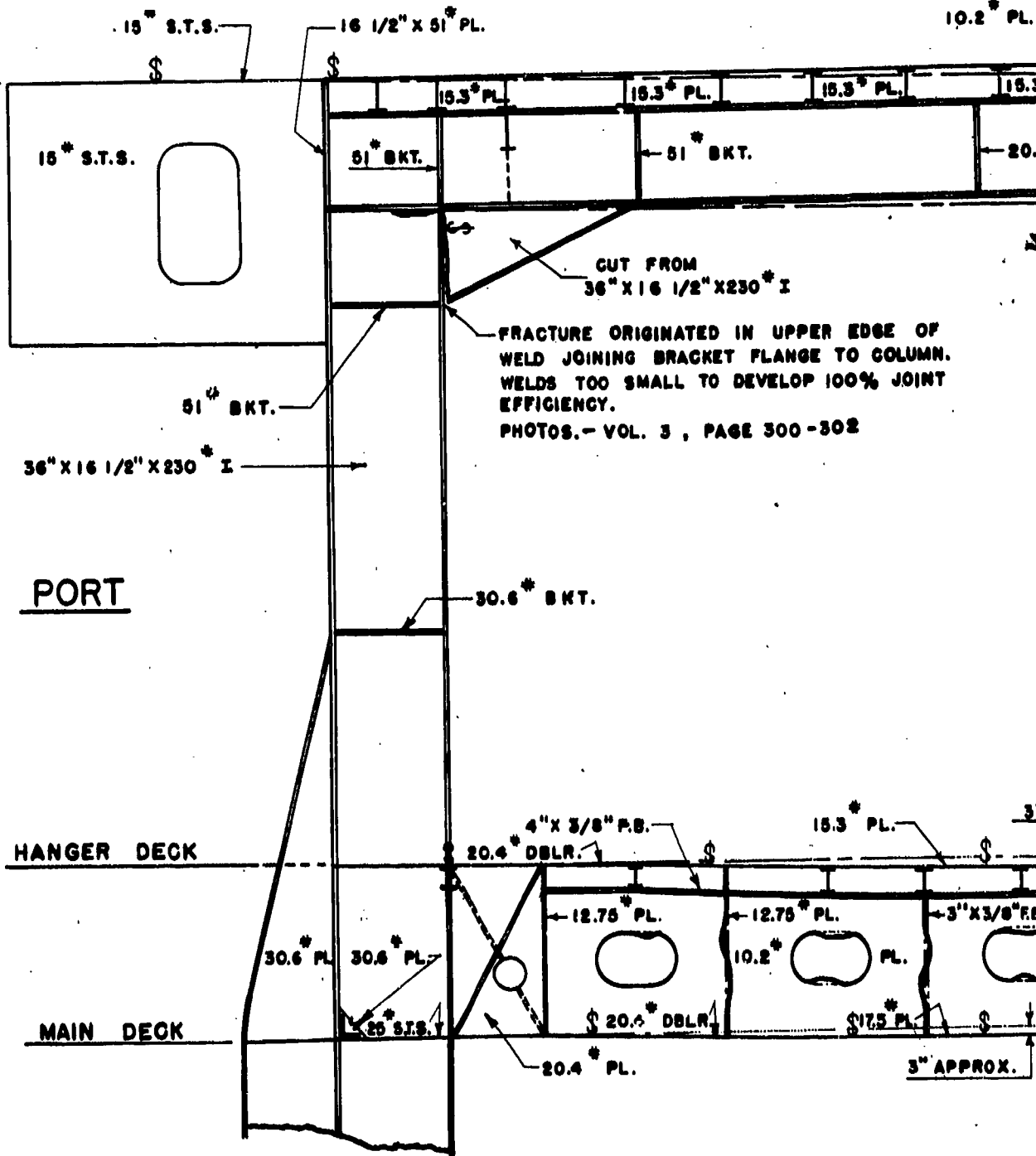

PORT

HANGER DECK

MAIN DECK

CUT FROM
36" X 16 1/2" X 230* I

FRACTURE ORIGINATED IN UPPER EDGE OF WELD JOINING BRACKET FLANGE TO COLUMN. WELDS TOO SMALL TO DEVELOP 100% JOINT EFFICIENCY.

PHOTOS. - VOL. 3, PAGE 300-302

3" APPROX.

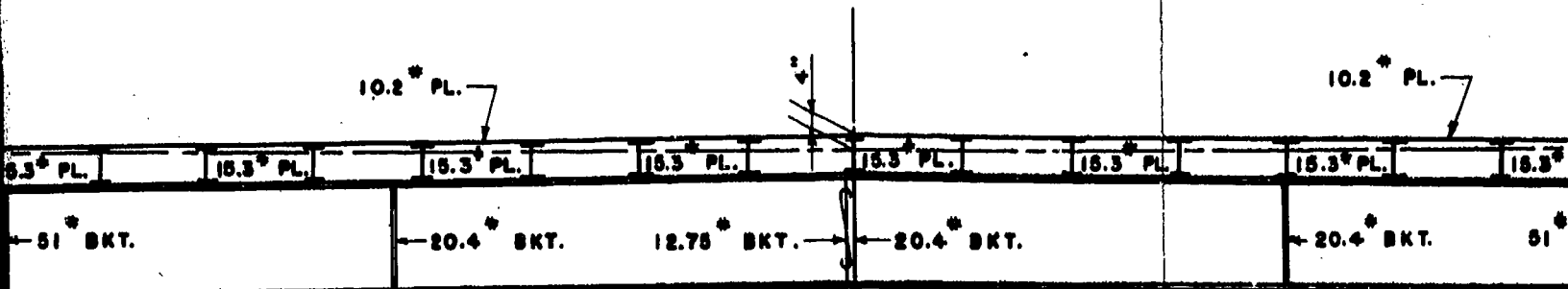

FROM
 16 1/2" X 230" I
 ORIGINATED IN UPPER EDGE OF
 BRACKET FLANGE TO COLUMN.
 SHALL TO DEVELOP 100% JOINT
 3, PAGE 300-302

H.T.S. 30" X 10 1/2" X 124" I

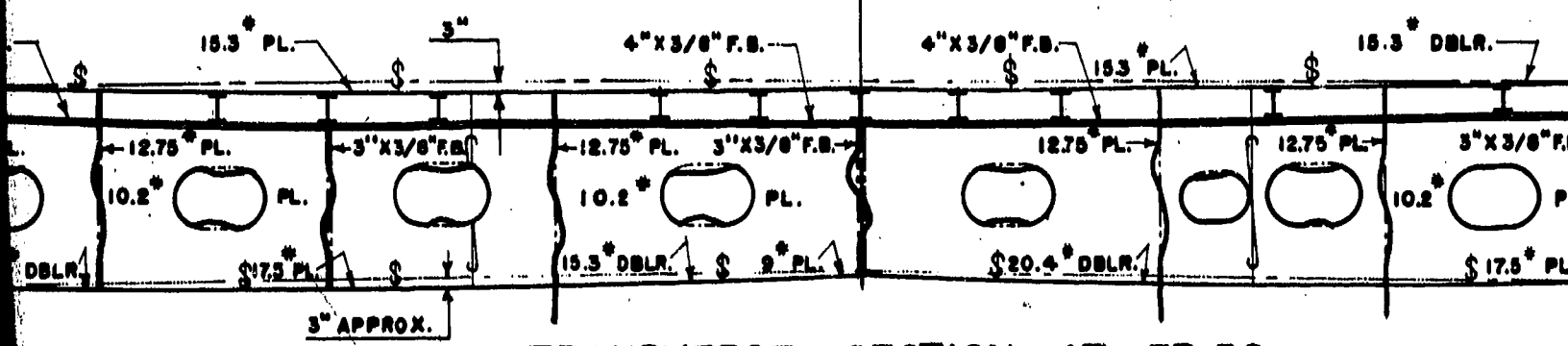

TRANSVERSE SECTION AT FR.56
 LOOKING FORD.

2

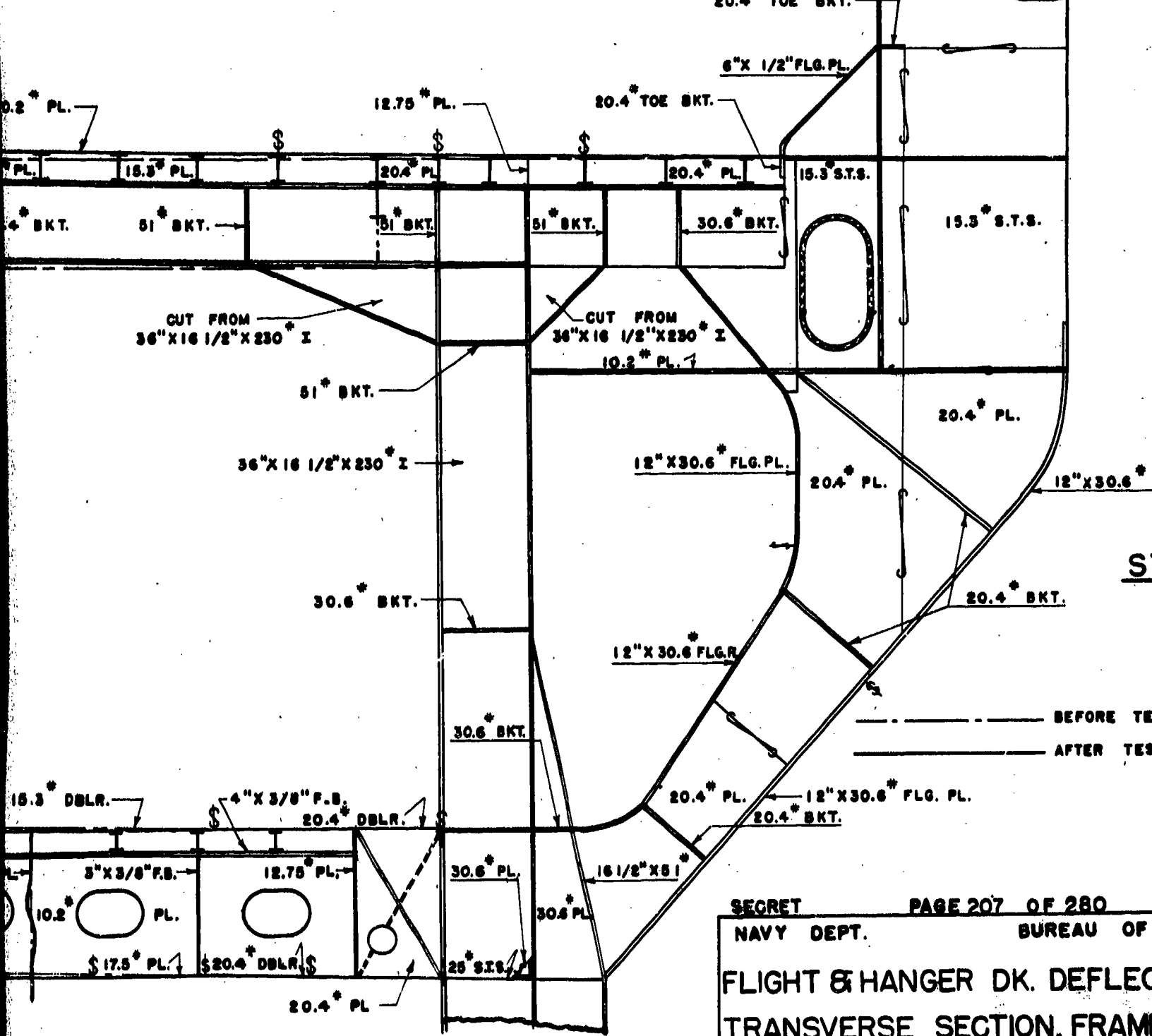

SECRET PAGE 207 OF 280
 NAVY DEPT. BUREAU OF
 FLIGHT & HANGER DK. DEFLEC
 TRANSVERSE SECTION, FRAME

TEST A

U.S.S. INDEPENDENCE CVL

PLATE NO.5

3

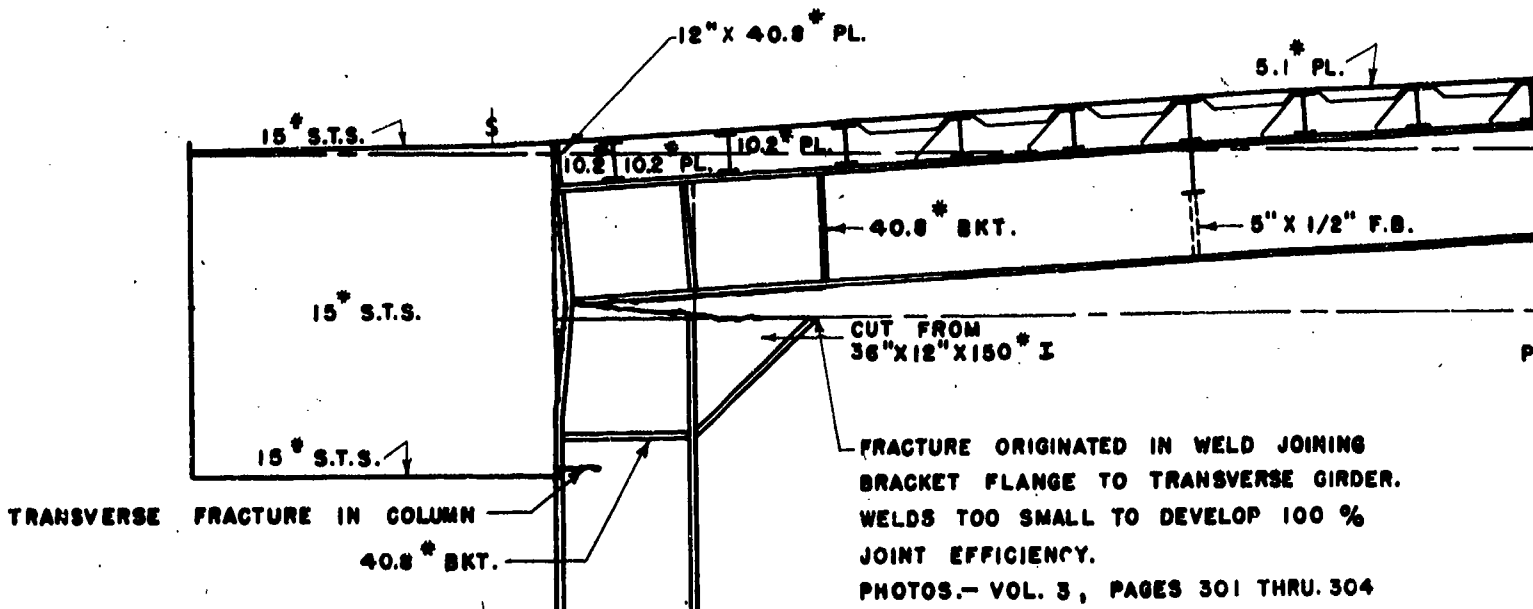

PORT

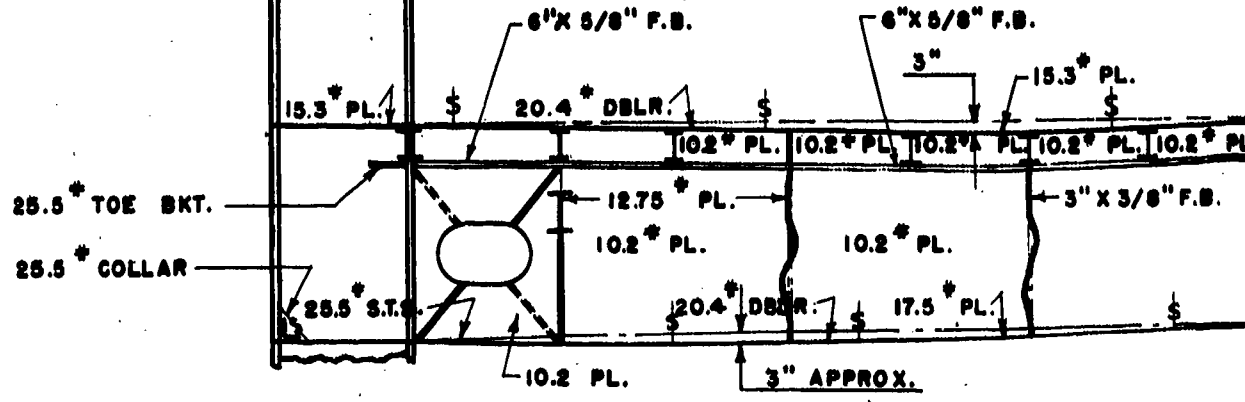

TR

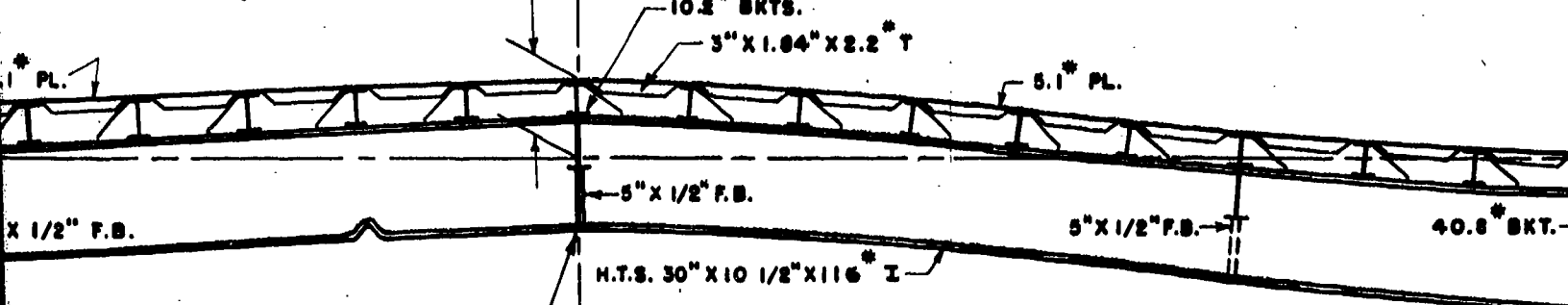
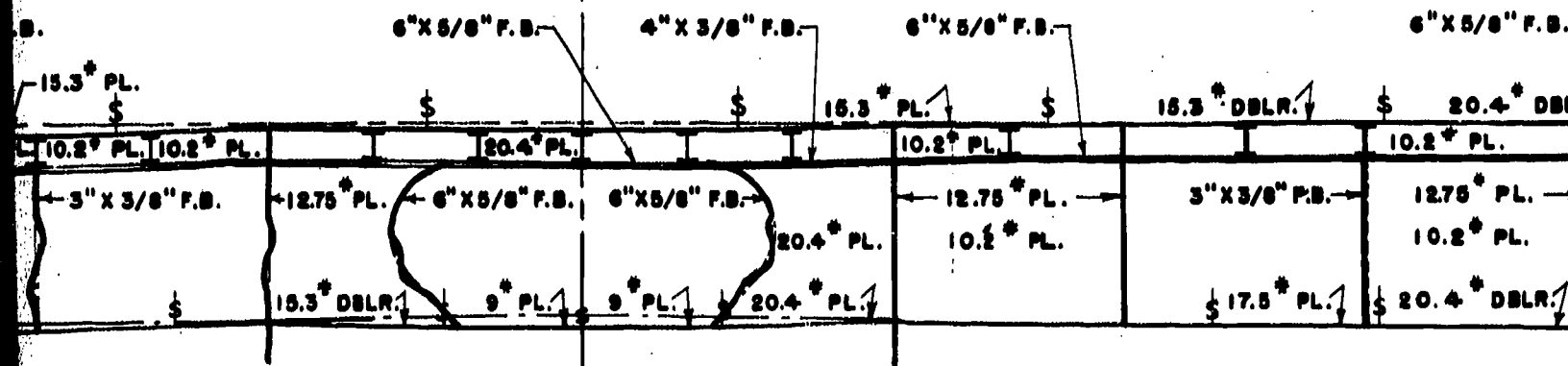

PHOTO. PAGES 305-308

CUT FROM
 36" X 12" X 150" I

JOINING
 GIRDER.
 100 %
 RU. 304

FRACTURE ORIGINATED IN WELD JOINT
 TRIPPING BRACKET TO INBOARD FLOOR
 TO COLUMN
 PHOTOS. - VOL. 3, PAGE 309



TRANSVERSE SECTION AT FR. 59
 LOOKING FORD.

2

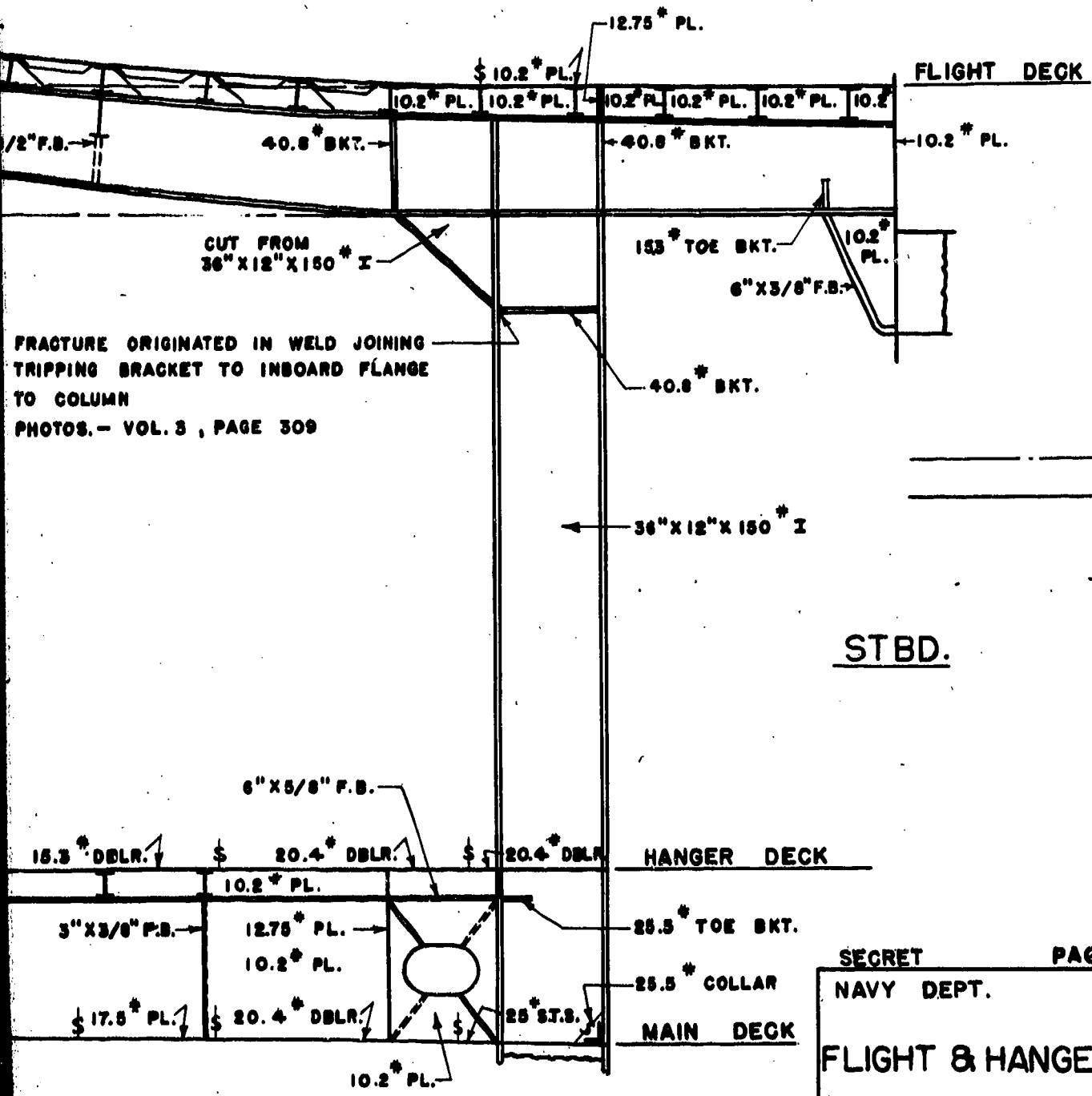

FRACTURE ORIGINATED IN WELD JOINING
TRIPPING BRACKET TO INBOARD FLANGE
TO COLUMN
PHOTOS. - VOL. 3 , PAGE 309

SECRET PAGE 208 OF 280
NAVY DEPT. BUREAU OF
FLIGHT & HANGER DK. DEFLE
TRANSVERSE SECTION, FRAM
TEST A
U.S.S. INDEPENDENCE

PLATE NO. 6

3

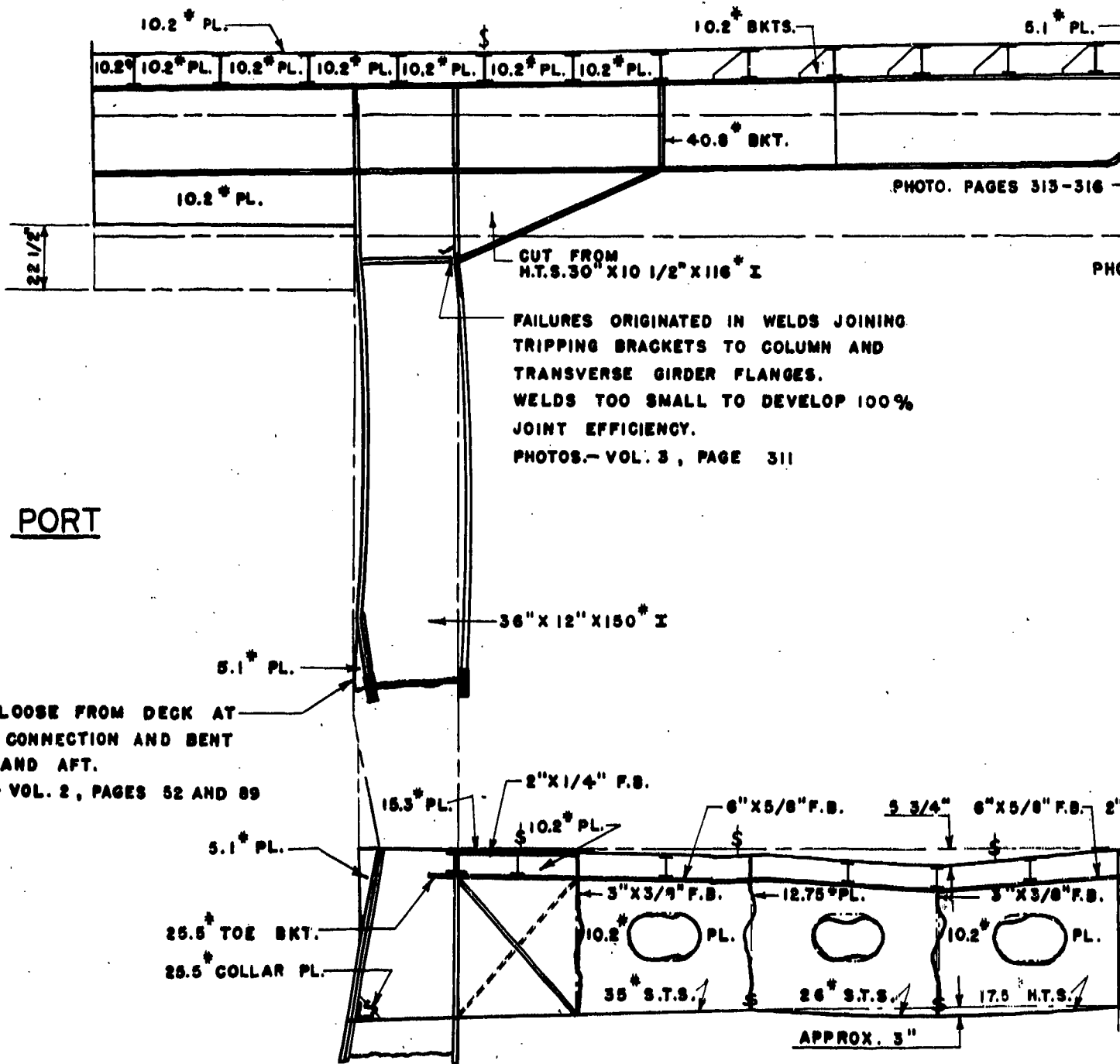

PORT

PULLED LOOSE FROM DECK AT RIVETED CONNECTION AND BENT UPWARD AND AFT.
 PHOTOS. - VOL. 2, PAGES 52 AND 59

CUT FROM
 H.T.S. 36" X 10 1/2" X 116" I

FAILURES ORIGINATED IN WELDS JOINING TRIPPING BRACKETS TO COLUMN AND TRANSVERSE GIRDER FLANGES.
 WELDS TOO SMALL TO DEVELOP 100% JOINT EFFICIENCY.
 PHOTOS. - VOL. 3, PAGE 311

PHOTO. PAGES 315-316

PHO

TRA

1

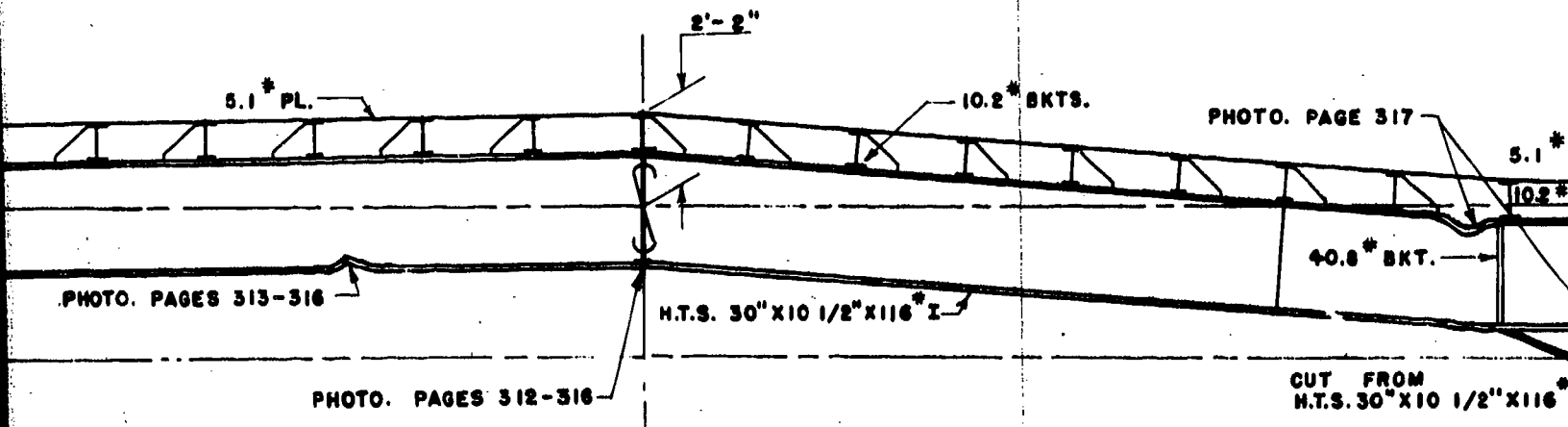

DINING
 AND
 100%

36" X 116"
 PULLED LOOSE FROM DECK
 RIVETED CONNECTION.

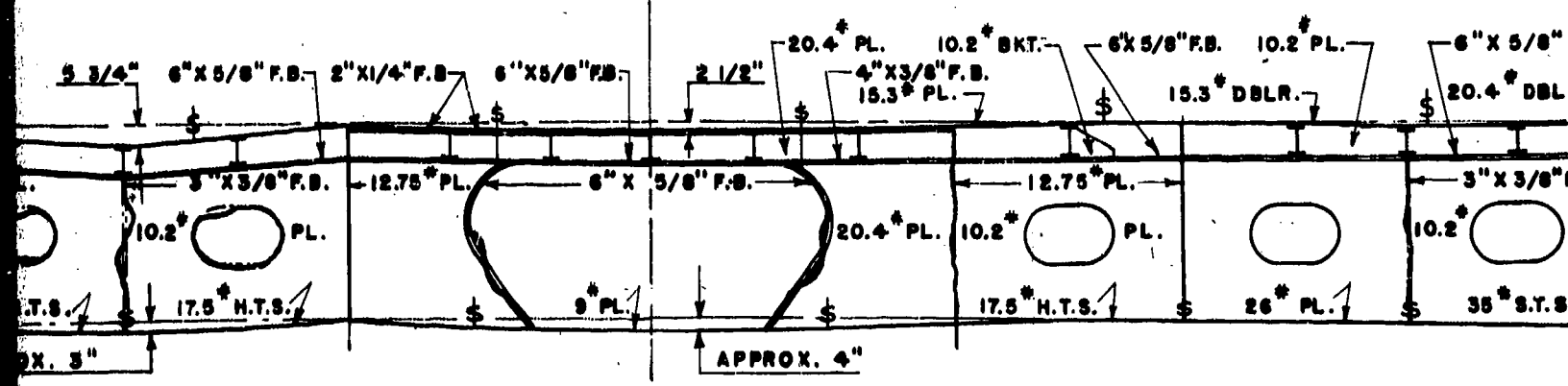

TRANSVERSE SECTION AT FR. 62
 LOOKING FORD.

2

PHOTO. PAGE 317

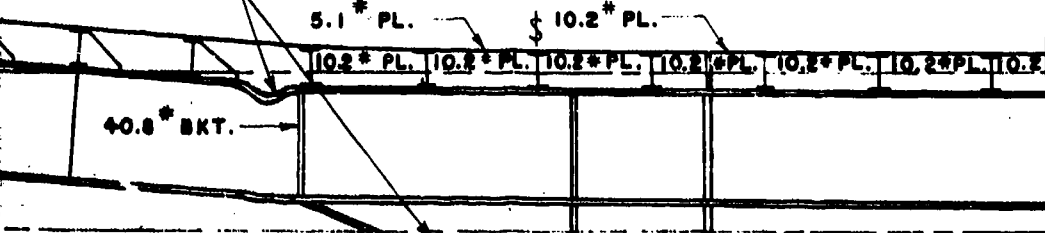

FLIGHT DECK

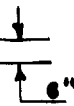

CUT FROM
M.T.S. 30" X 10 1/2" X 116 I

40.8* BKT.

1/2" F.B.

1/2" F.B.

----- BEFORE TEST
 _____ AFTER TEST

STBD.

36" X 12" X 150 I

PULLED LOOSE FROM DECK AT
RIVETED CONNECTION.

PHOTO. PAGES 318 AND 319



HANGER DECK

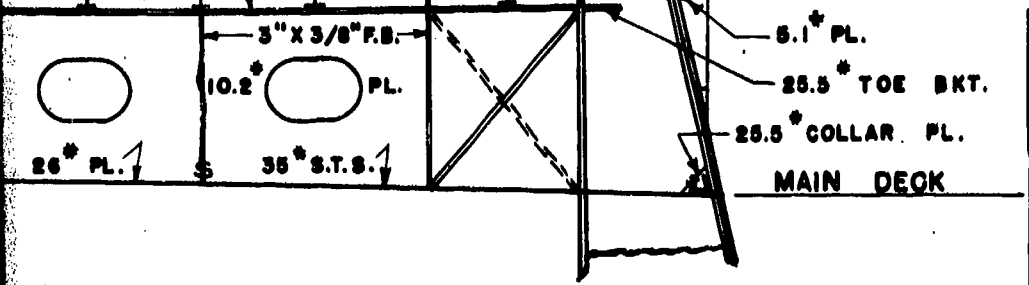

MAIN DECK

SECRET PAGE 209 OF 280
 NAVY DEPT. BUREAU OF

FLIGHT & HANGER DK. DEFLECTION
 TRANSVERSE SECTION, FORWARD

TEST A

U.S. INDEPENDENCE

CV

PLATE NO. 7

18"
20"

PORT

FRACTURE ORIGINATED IN WELD JOINING
BRACKET FLANGE TO COLUMN.
WELD TOO SMALL TO DEVELOP 100%
JOINT EFFICIENCY.
PHOTOS.- VOL. 3 PAGES 329, 330

PULLED LOOSE FROM DECK
AT RIVETED CONNECTION
PHOTO. PAGES 327, 328

21"

TRANS

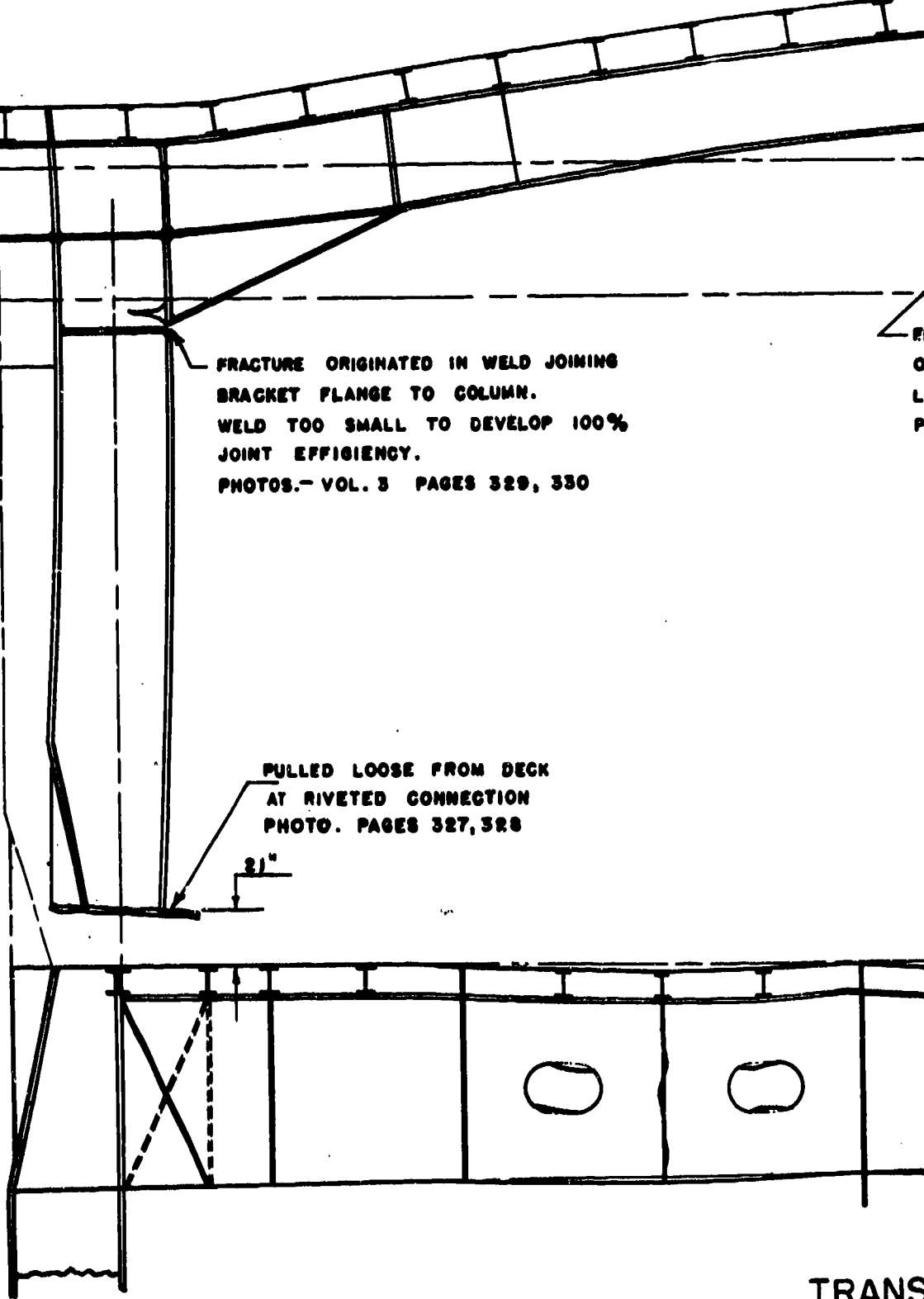



FRACTURE ORIGINATED IN LOWER FLANGE
OF GIRDER AT EDGE OF WELDED CENTER-
LINE BUTT.

PHOTOS.- VOL. 3 PAGES 320, 323, 326

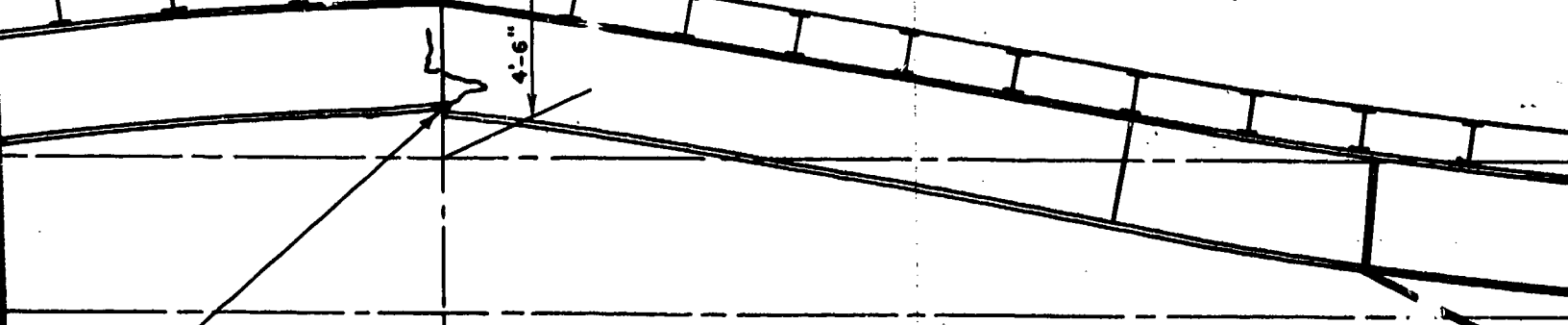

FRACTURE ORIGINATED AT EDGE OF WELD
JOINING BRACKET FLANGE TO COLUMN.
STRUCTURAL DISCONTINUITY IN DESIGN OF
CONNECTION CONTRIBUTED TO FAILURE.
PHOTOS.- VOL. 3 PAGES 331, 332

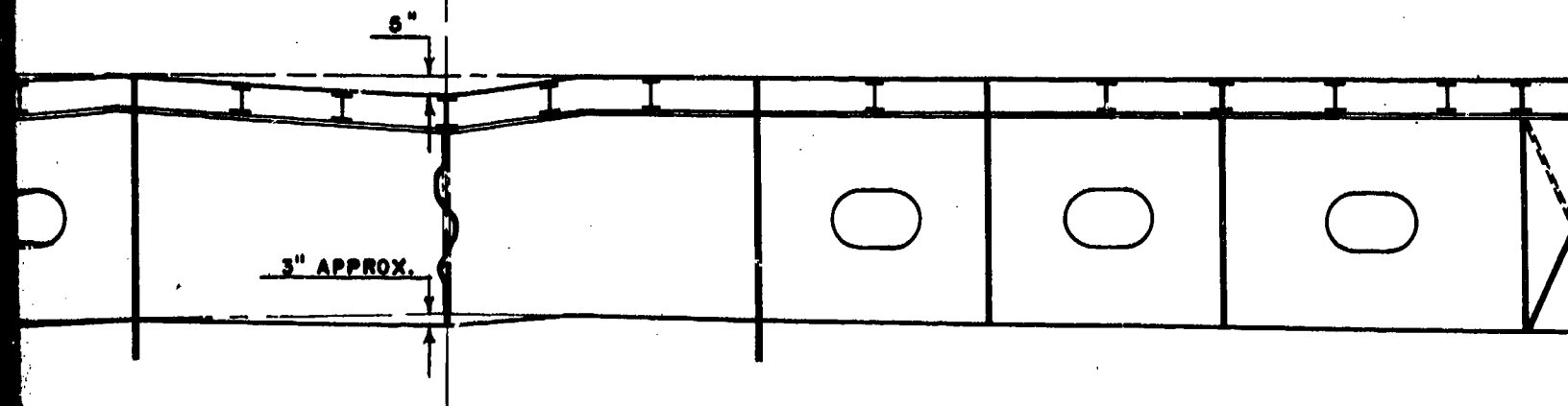

PULLED LOOSE FROM DECK
AT RIVETED CONNECTION
PHOTO. PAGES 333, 334



TRANSVERSE SECTION AT FR.65
LOOKING FORD.

2

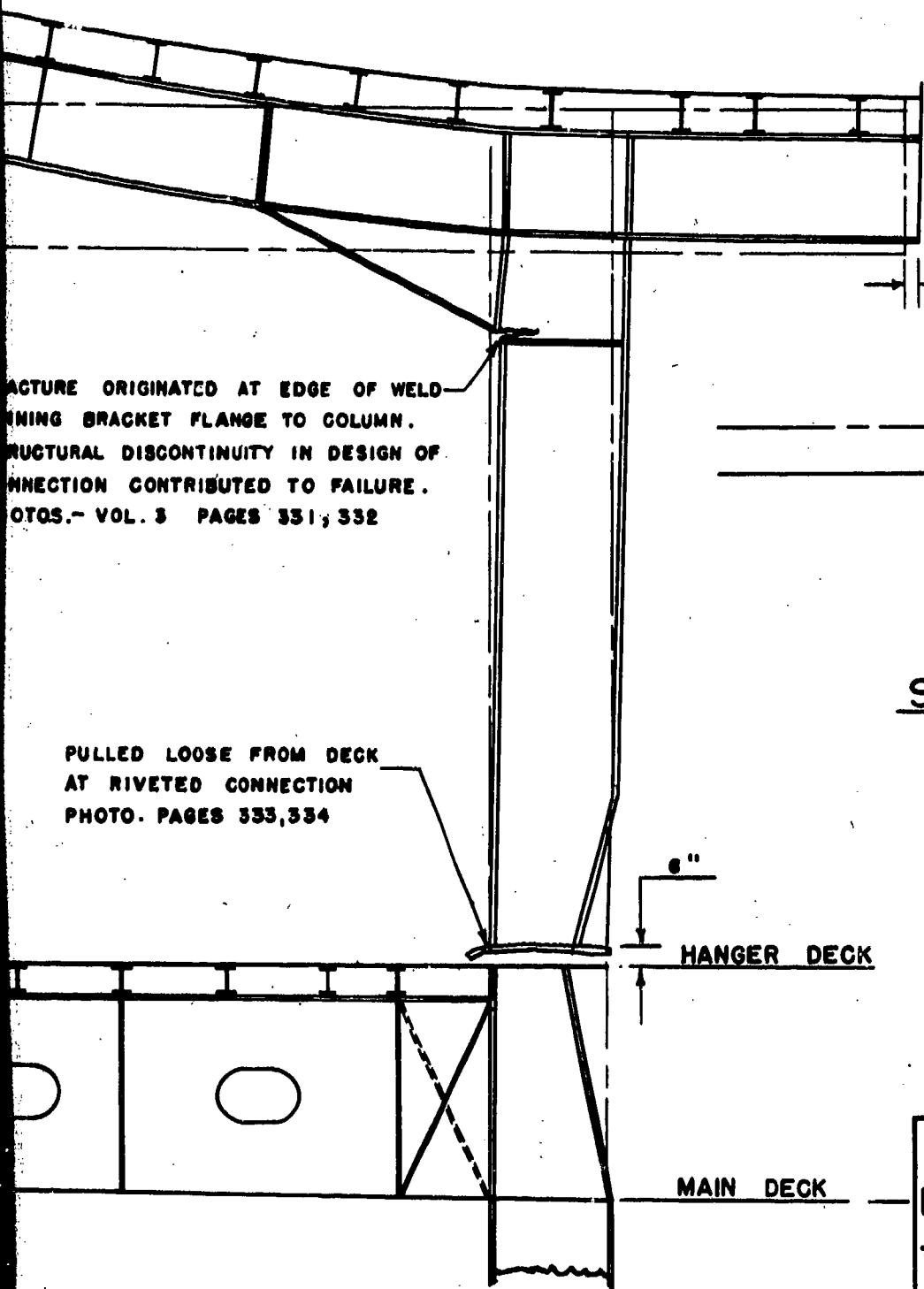

FLIGHT DECK

4"

FAILURE ORIGINATED AT EDGE OF WELDING BRACKET FLANGE TO COLUMN. STRUCTURAL DISCONTINUITY IN DESIGN OF CONNECTION CONTRIBUTED TO FAILURE. PHOTOS.- VOL. 3 PAGES 331, 332

----- BEFORE TEST
 ----- AFTER TEST

STB'D.

PULLED LOOSE FROM DECK AT RIVETED CONNECTION PHOTO. PAGES 333, 334

6"

HANGER DECK

MAIN DECK

SECRET PAGE 210 OF 280
 NAVY DEPT. BUREAU OF
 FLIGHT & HANGER DK. DEFLECT
 TRANSVERSE SECTION, FRAMING
 TEST A
 U.S.S. INDEPENDENCE

PLATE NO. 8

3

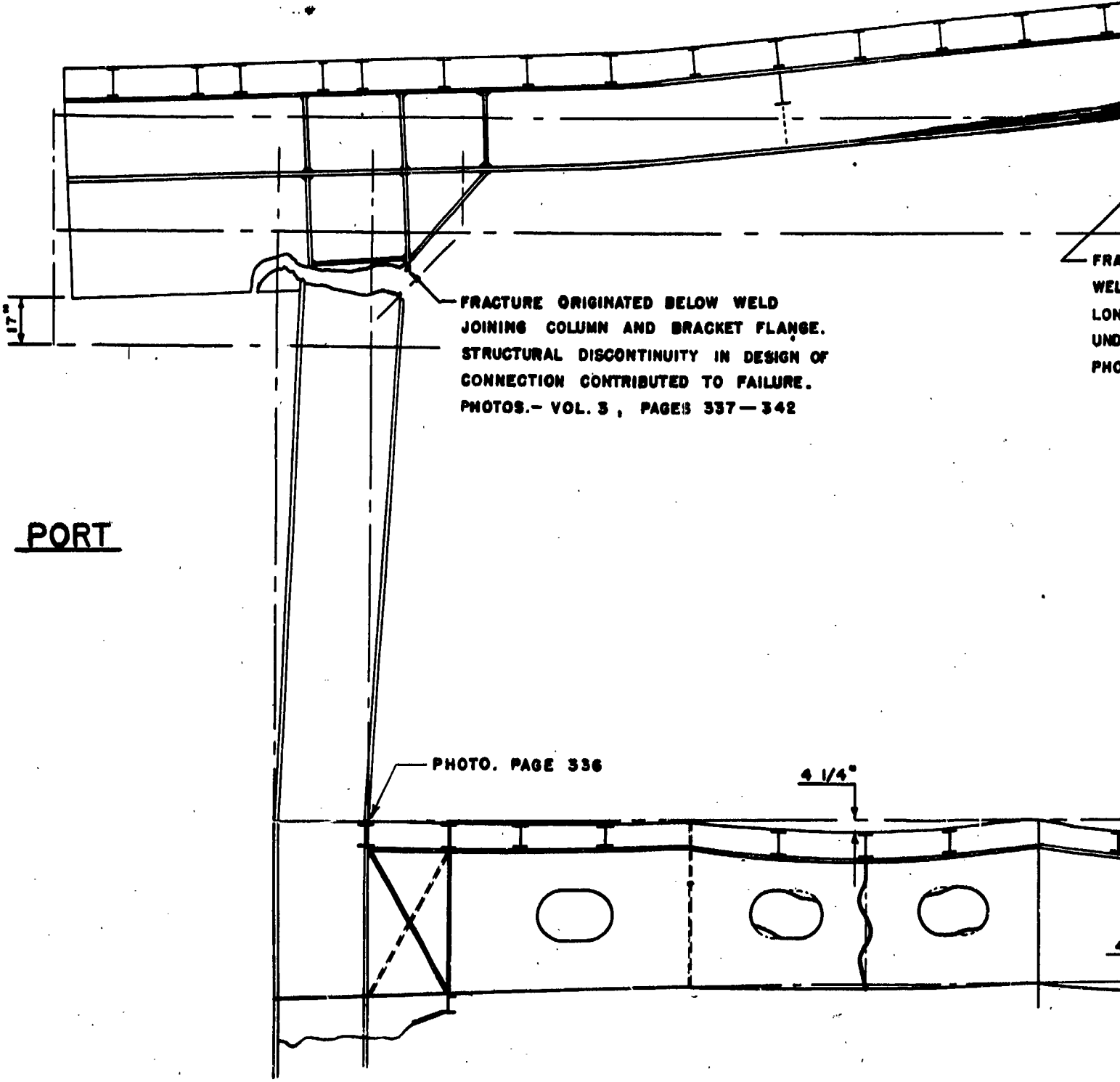

FRACTURE ORIGINATED BELOW WELD JOINING COLUMN AND BRACKET FLANGE. STRUCTURAL DISCONTINUITY IN DESIGN OF CONNECTION CONTRIBUTED TO FAILURE. PHOTOS.- VOL. 3 , PAGES 337-342

PORT

PHOTO. PAGE 336

4 1/4°

TRANSVERSE

FRA
WEL
LON
UND
PHO

FRACTURE ORIGINATED AT AFTER END OF
WELD JOINING TRIPPING BRACKET AND
LONGITUDINAL BRACKET.
UNDERSIZE WELDS CONTRIBUTED TO FAILURE.
PHOTOS.— VOL. 3 , PAGES 343,344,346

FRACTURE ORIGINATED IN WELD JOINING
BRACKET FLANGE TO TRANSVERSE GIRDER.
WELD TOO SMALL TO DEVELOP 100 %
JOINT EFFICIENCY.
PHOTOS.— VOL. 3 , PAGES 348-350

6"
4" APPROX.

TRANSVERSE SECTION AT FR. 68
LOOKING FORD.

FLIGHT DECK

12"

ORIGINATED IN WELD JOINING
FLANGE TO TRANSVERSE GIRDER.
TO SMALL TO DEVELOP 100 %
EFFICIENCY.

VOL. 3 , PAGES 348 - 350

BEFORE TEST

AFTER TEST

ST'B'D.

HANGER DECK

MAIN DECK

SECRET

PAGE 211 OF 280

NAVY DEPT.

BUREAU OF

FLIGHT & HANGER DK. DEFLEC

TRANSVERSE SECTION, FRAME

TEST A

U.S.S. INDEPENDENCE

CVL

PLATE NO. 9

3

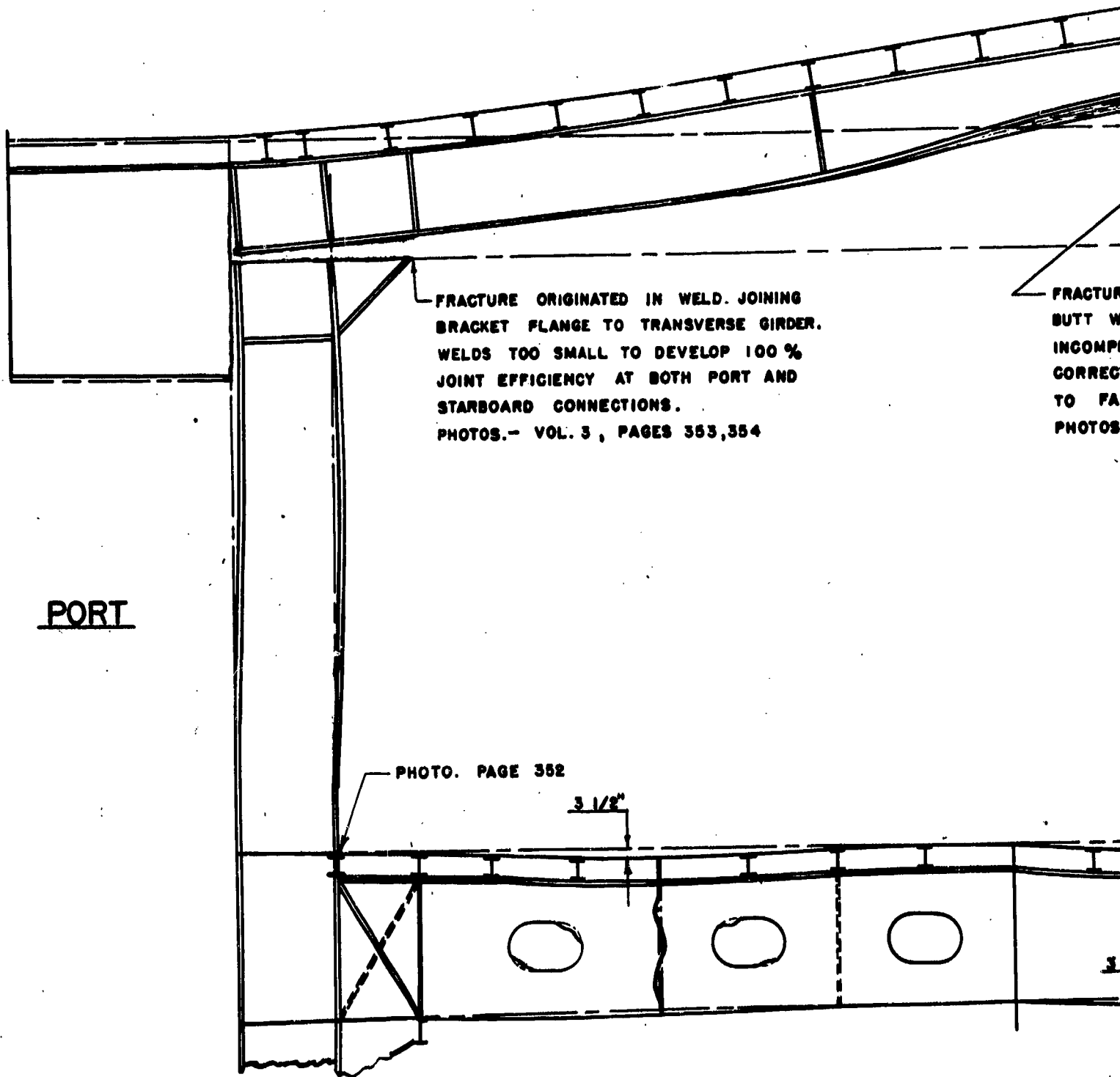

FRACTURE ORIGINATED IN WELD. JOINING
BRACKET FLANGE TO TRANSVERSE GIRDER.
WELDS TOO SMALL TO DEVELOP 100 %
JOINT EFFICIENCY AT BOTH PORT AND
STARBOARD CONNECTIONS.
PHOTOS.- VOL. 3 , PAGES 353,354

FRACTURE
BUTT WELD
INCOMPLETE
CORRECTION
TO FAILURE
PHOTOS

PORT

PHOTO. PAGE 352

3 1/8"

TRANSVERSE

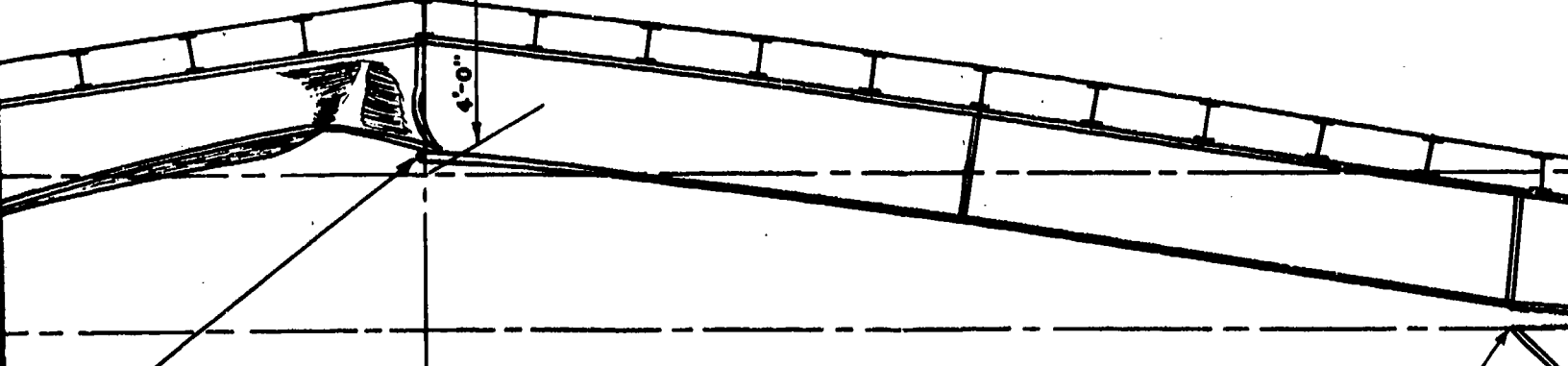

FRACTURE ORIGINATED IN AFTER END OF BUTT WELD IN LOWER FLANGE OF GIRDER. INCOMPLETE WELD PENETRATION AND INCORRECT EDGE PREPARATION CONTRIBUTED TO FAILURE.
PHOTOS.- VOL. 3 , PAGES 355 - 357

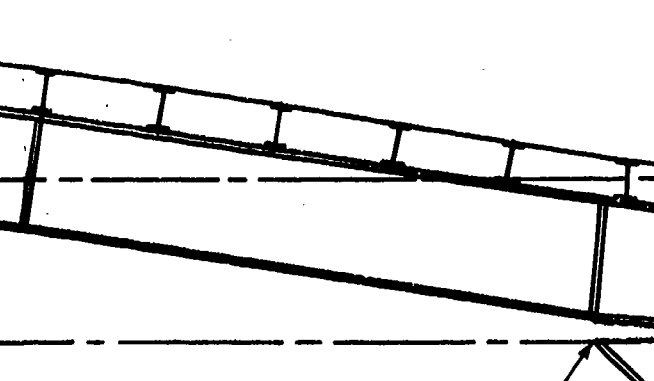

FRACTURE ORIGINATED IN WELD AT INBOARD TOE OF BRACKET.
PHOTOS.- VOL. 3 , PAGE 358

PHOTO. PAGE 359



3" APPROX.

TRANSVERSE SECTION AT FR. 71
LOOKING FORD.

2

FLIGHT DECK

ORIGINATED IN WELD AT
OF BRACKET.
L. 3, PAGE 358

PHOTO. PAGE 360

BEFORE

AFTER

STBD.

PHOTO. PAGE 359

PHOTO. PAGE 361

HANGER DECK

MAIN DECK

SECRET

PAGE 212 OF 280

NAVY DEPT.

BUREAU OF

FLIGHT & HANGER DK. DEFLE

TRANSVERSE SECTION, FRAM

TEST A

U.S. INDEPENDENCE

CI

PLATE NO. 10

3

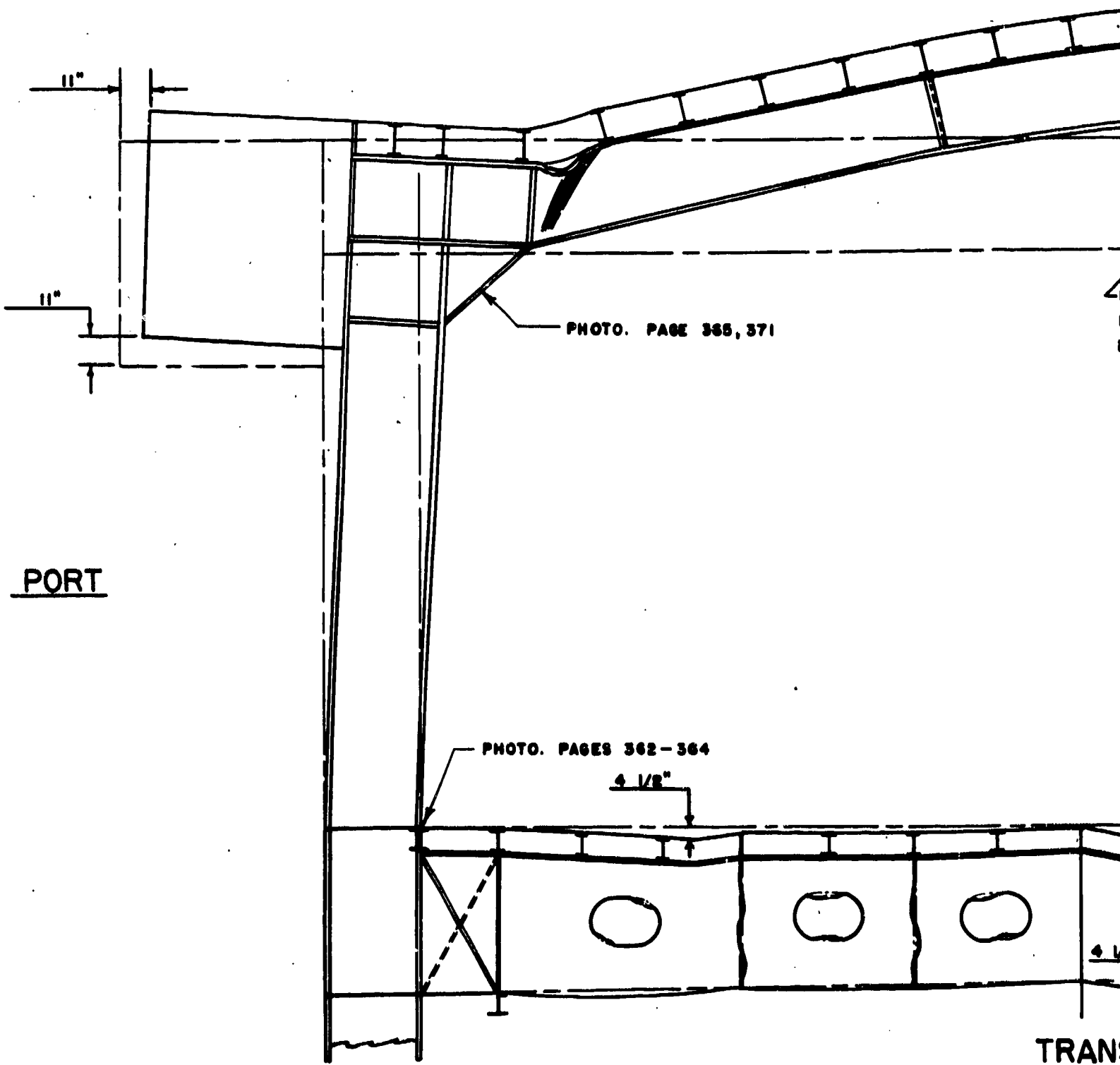

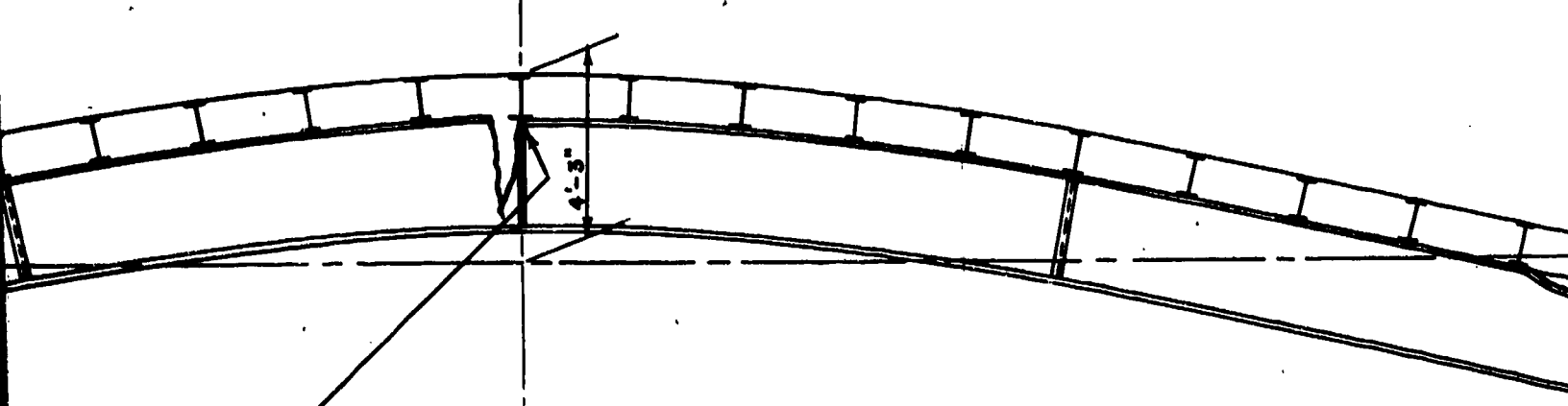

← FRACTURE ORIGINATED AT EDGE OF WELD
 IN TOP FLANGE OF GIRDER.
 PHOTOS.- VOL. 3, PAGES 366-369, 375, 376

FRACTURE ORIGINATED AT UPPER
 OF WELD JOINING GIRDER AND
 BRACKET FLANGES.
 DISCONTINUITY IN STRUCTURAL DES
 OF CONNECTION CONTRIBUTED TO
 PHOTOS.-VOL. 3, PAGES 370, 372

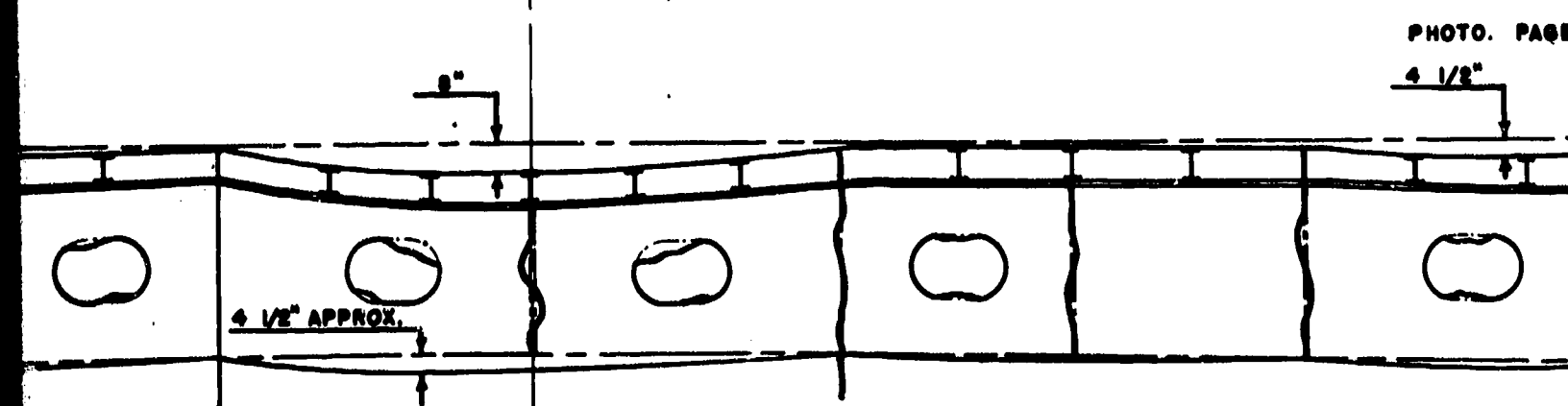

PHOTO. PAGE

4 1/2"

4 1/2" APPROX.

TRANSVERSE SECTION AT FR. 74
 LOOKING FORD.

2

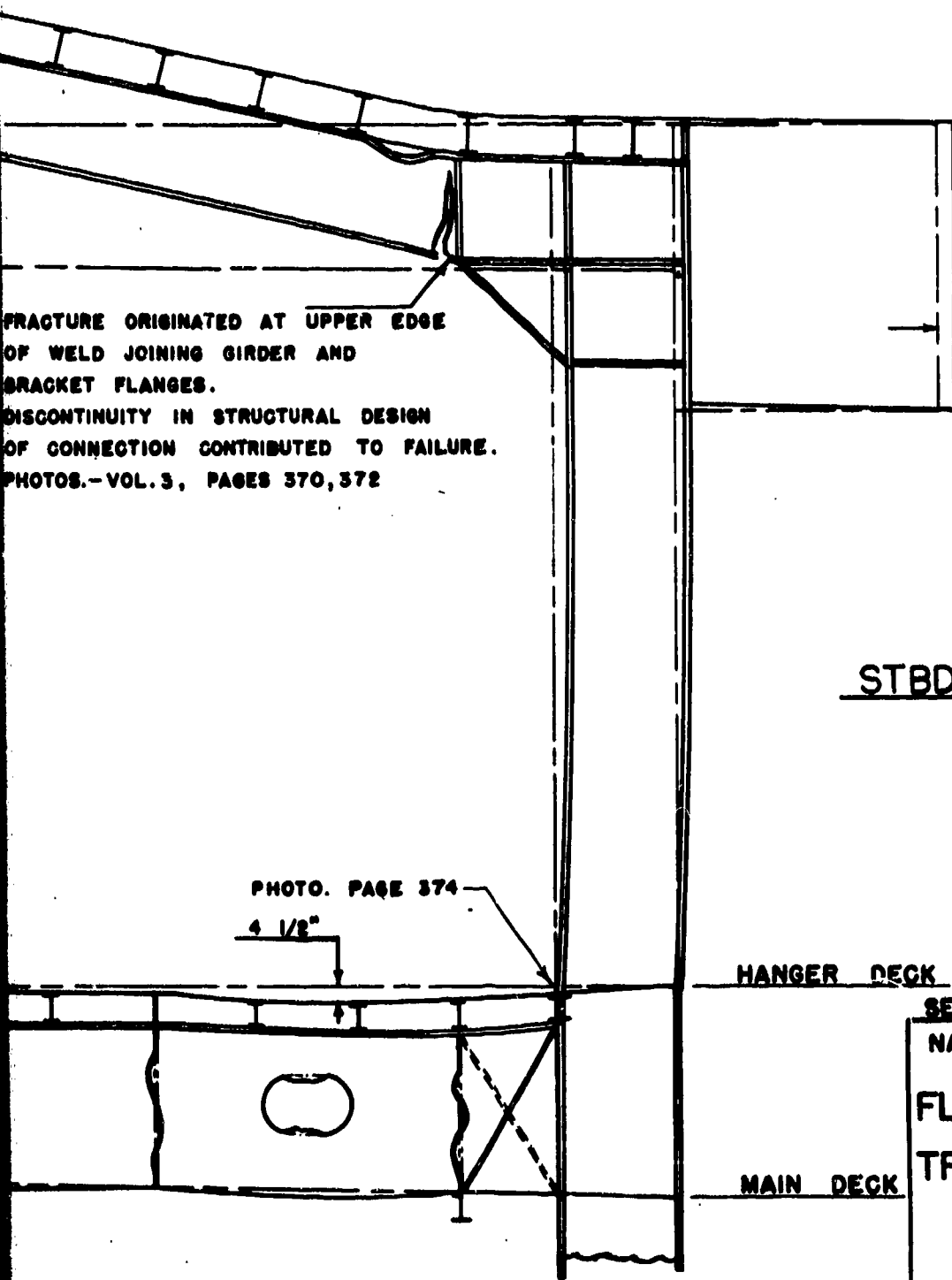

FRACTURE ORIGINATED AT UPPER EDGE
 OF WELD JOINING GIRDER AND
 BRACKET FLANGES.
 DISCONTINUITY IN STRUCTURAL DESIGN
 OF CONNECTION CONTRIBUTED TO FAILURE.
 PHOTOS.-VOL. 3, PAGES 370, 372

PHOTO. PAGE 374
 4 1/2"

FLIGHT DECK

4 1/2"

----- BEFORE TEST
 ----- AFTER TEST

STBD.

HANGER DECK

MAIN DECK

SECRET PAGE 213 OF 280
 NAVY DEPT. BUREAU OF
 FLIGHT & HANGER DK. DEFLE
 TRANSVERSE SECTION, FRAN
 TEST A
 U.S.S. INDEPENDENCE

PLATE NO. 11

3

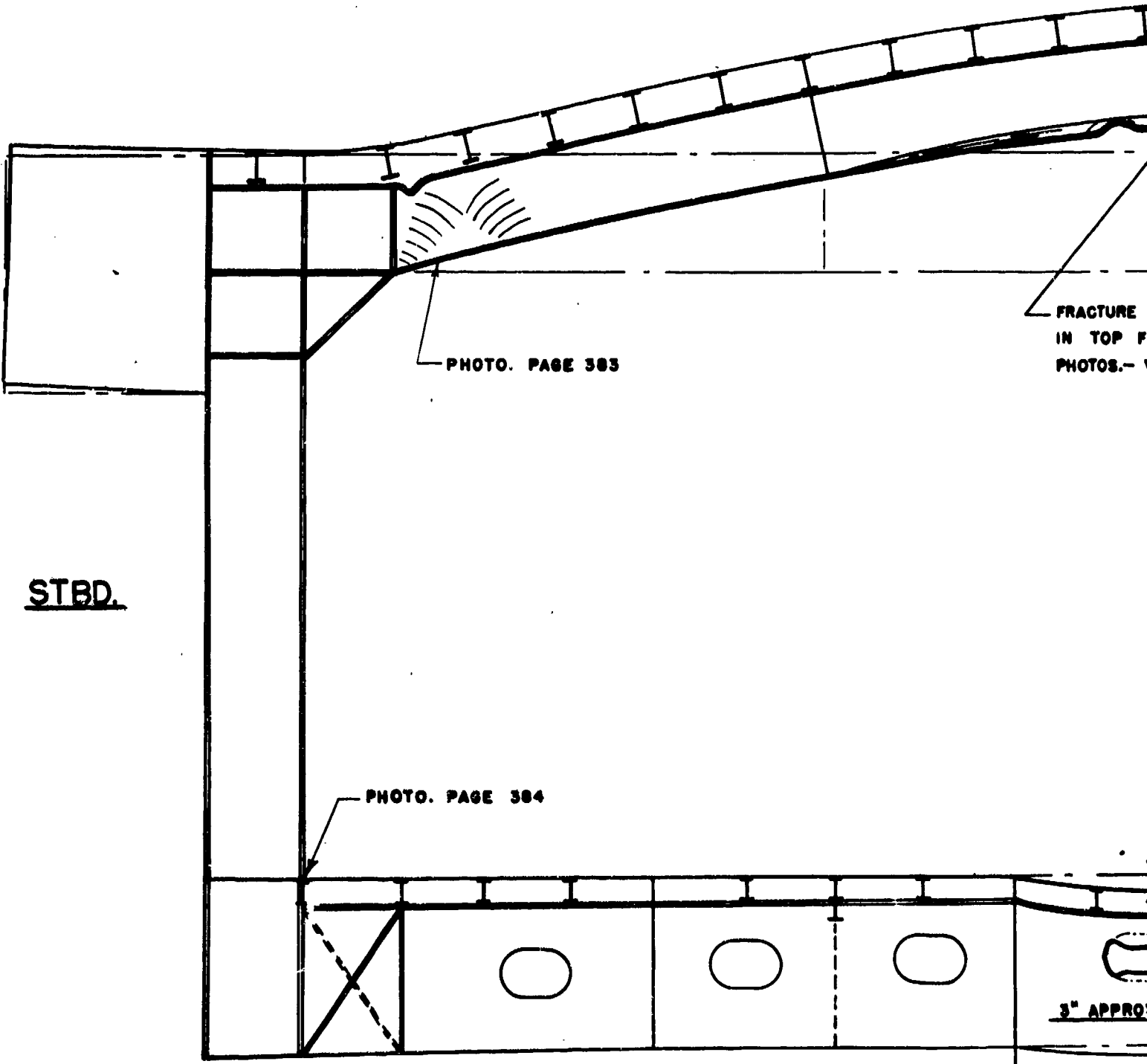

STBD.

PHOTO. PAGE 383

FRACTURE
IN TOP F
PHOTOS.-

PHOTO. PAGE 384

3" APPRO

TRANSVERS

1

RACTURE ORIGINATED AT EDGE OF WELD
TOP FLANGE OF GIRDER.

PHOTOS.- VOL. 3, PAGES 379 - 382

SLIGHT FRACTURE WITH ORIGIN AT UPPER
EDGE OF WELD JOINING COLUMN AND
BRACKET FLANGE.

PHOTOS.- VOL. 3 PAGE 378

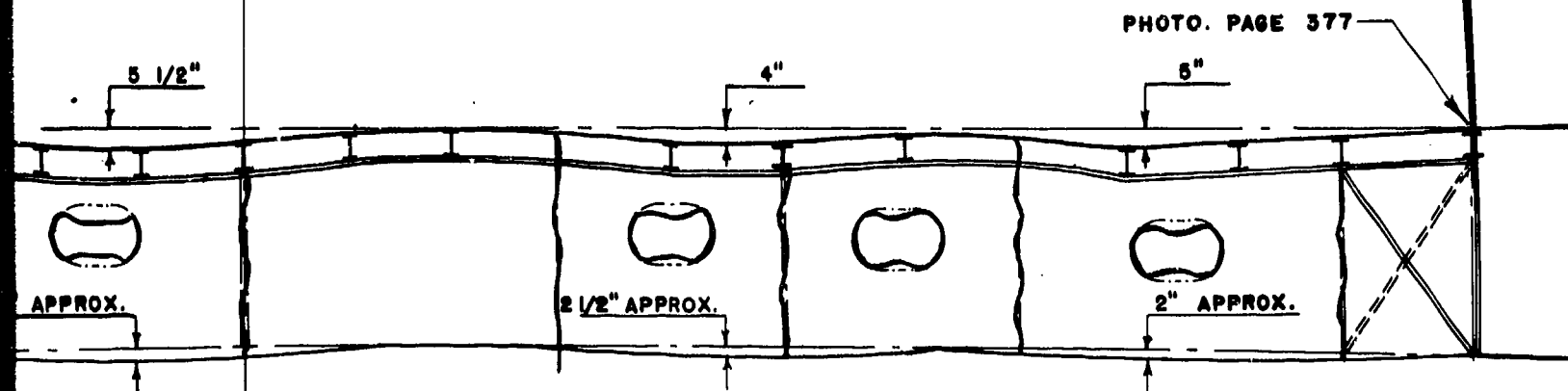

VERSE SECTION AT FR.77
LOOKING AFT.

1 2

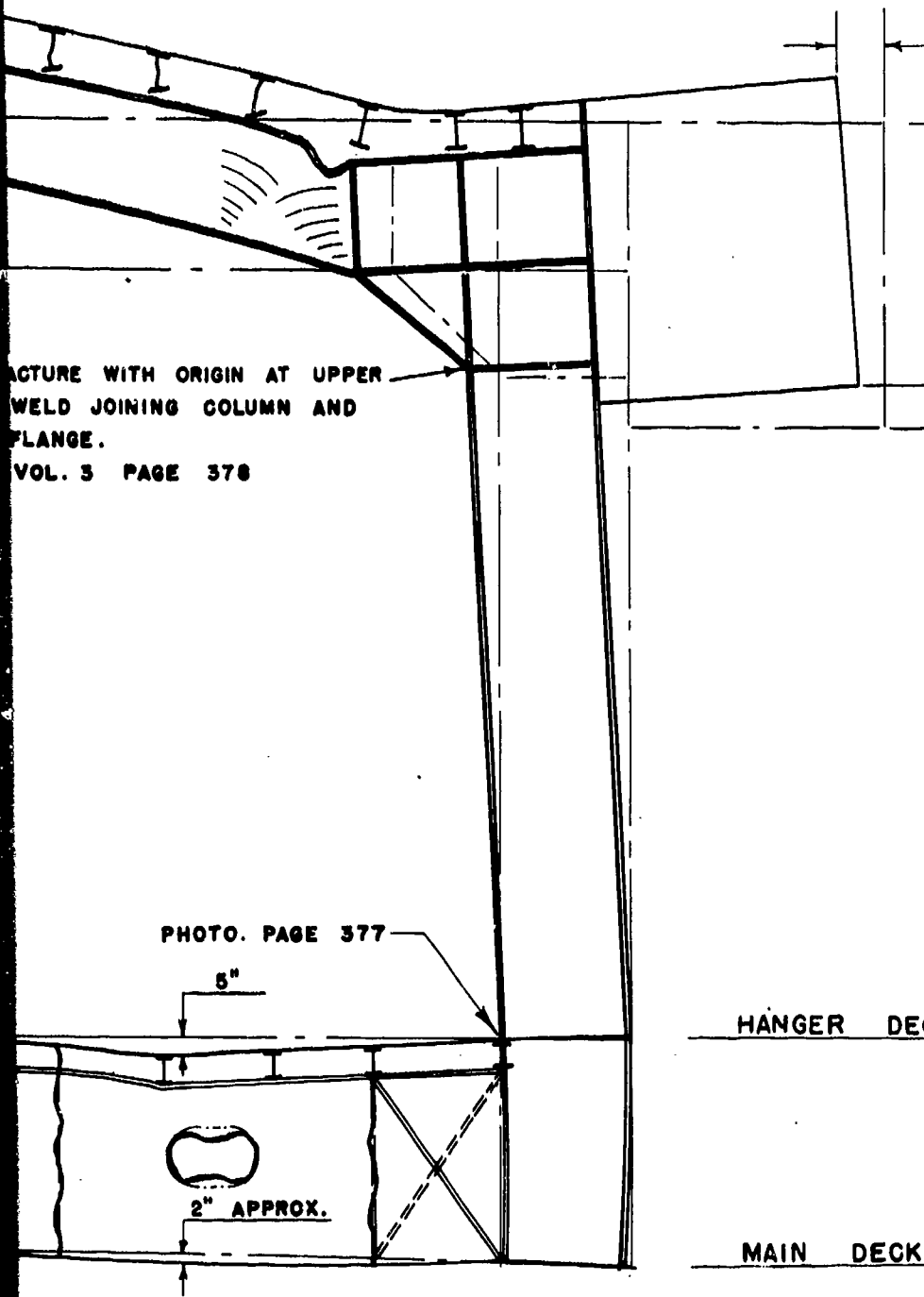

FRACTURE WITH ORIGIN AT UPPER
 WELD JOINING COLUMN AND
 FLANGE.
 VOL. 3 PAGE 378

PHOTO. PAGE 377

5"

2" APPROX.

1'-1"
 FLIGHT DECK

1'-0"

----- BEFORE TEST
 ----- AFTER TEST

PORT

HANGER DECK

MAIN DECK

SECRET

PAGE 214 OF 280

NAVY DEPT.

BUREAU OF

FLIGHT & HANGER DK. DEFLE

TRANSVERSE SECTION, FRAM

TEST A

U.S.S. INDEPENDENCE

C

PLATE NO. 12

3

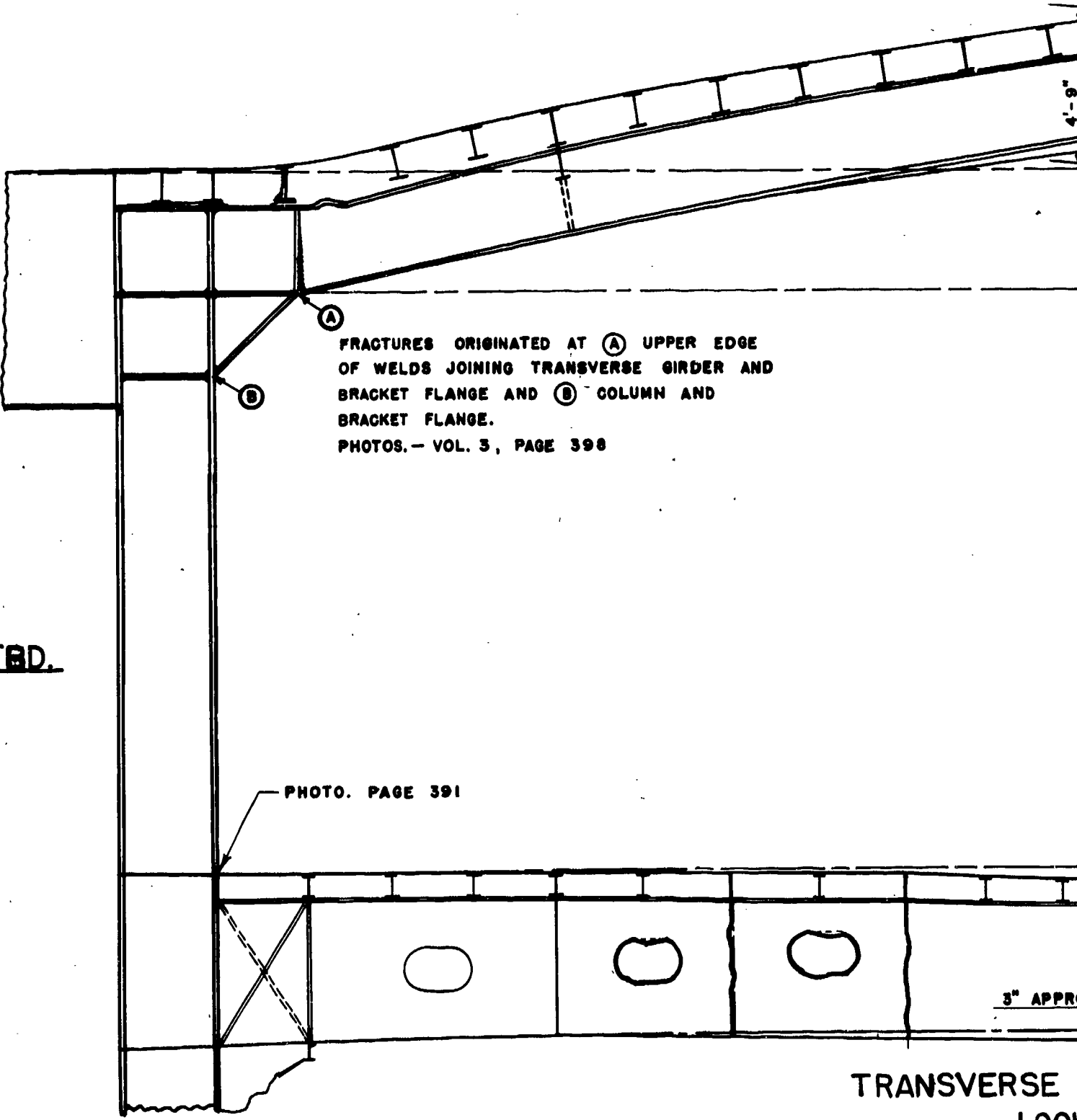

4'-9"

FRACTURES ORIGINATED AT (A) UPPER EDGE
OF WELDS JOINING TRANSVERSE GIRDER AND
BRACKET FLANGE AND (B) COLUMN AND
BRACKET FLANGE.
PHOTOS. - VOL. 3, PAGE 398

STBD.

PHOTO. PAGE 391

3" APPR

TRANSVERSE
LOOK

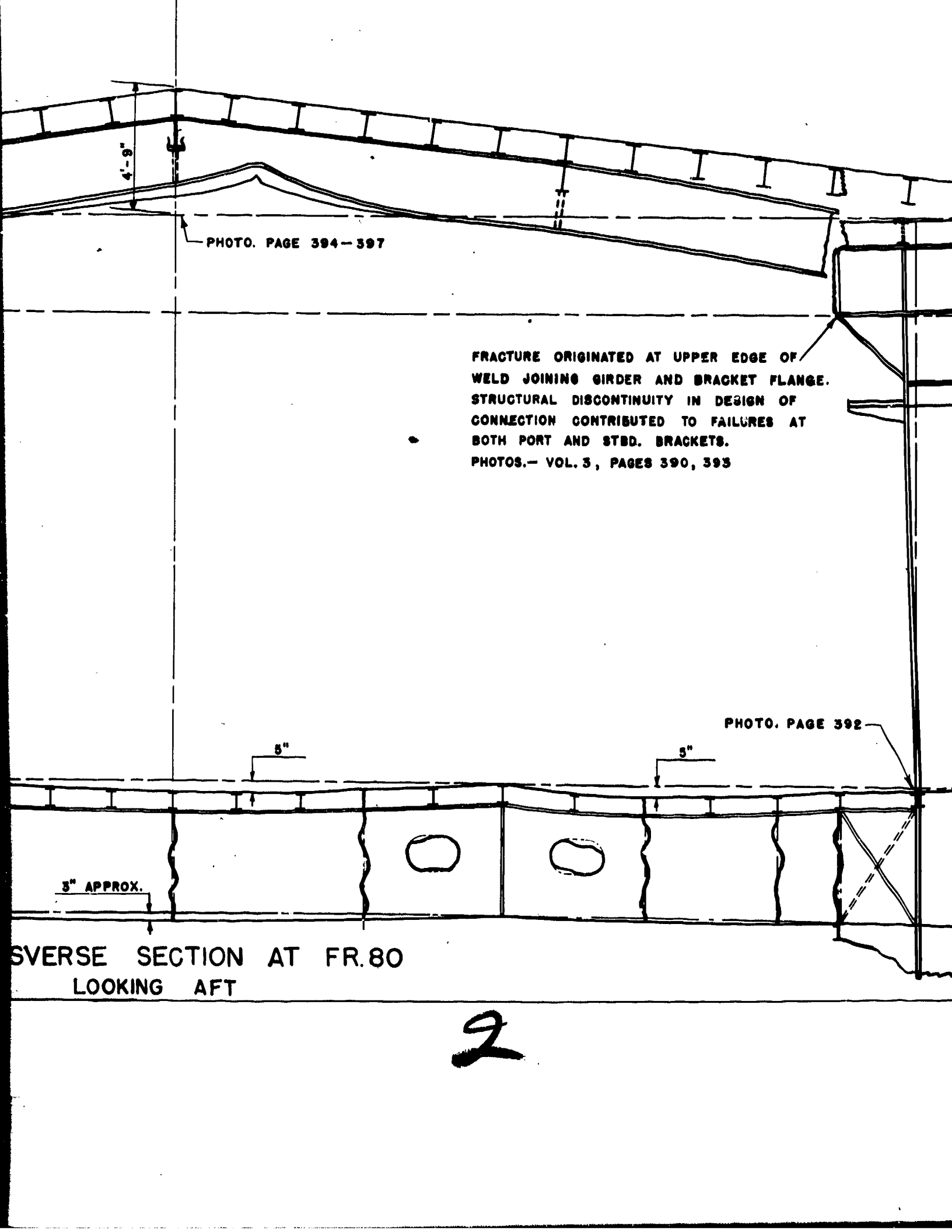

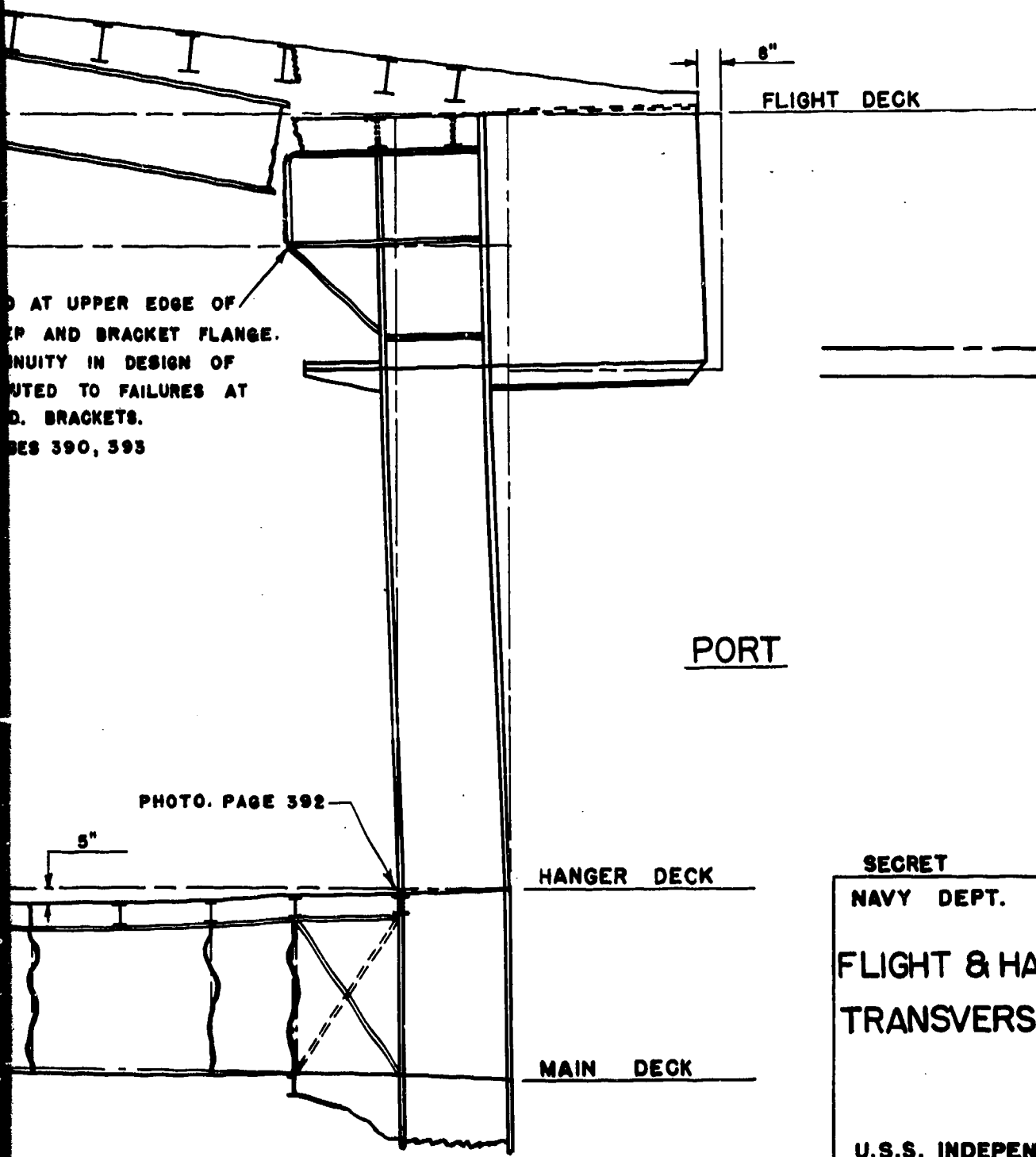

AT UPPER EDGE OF
 AND BRACKET FLANGE.
 CONTINUITY IN DESIGN OF
 DUE TO FAILURES AT
 BRACKETS.
 PAGES 390, 393

PHOTO. PAGE 392

8"
FLIGHT DECK

BEFORE TEST
AFTER TEST

PORT

5"
HANGER DECK

MAIN DECK

SECRET PAGE. 215 OF
 NAVY DEPT. BUREAU
 FLIGHT & HANGER DK. DEFL
 TRANSVERSE SECTION, FRA
 TEST A
 U.S.S. INDEPENDENCE

PLATE NO. 13

3

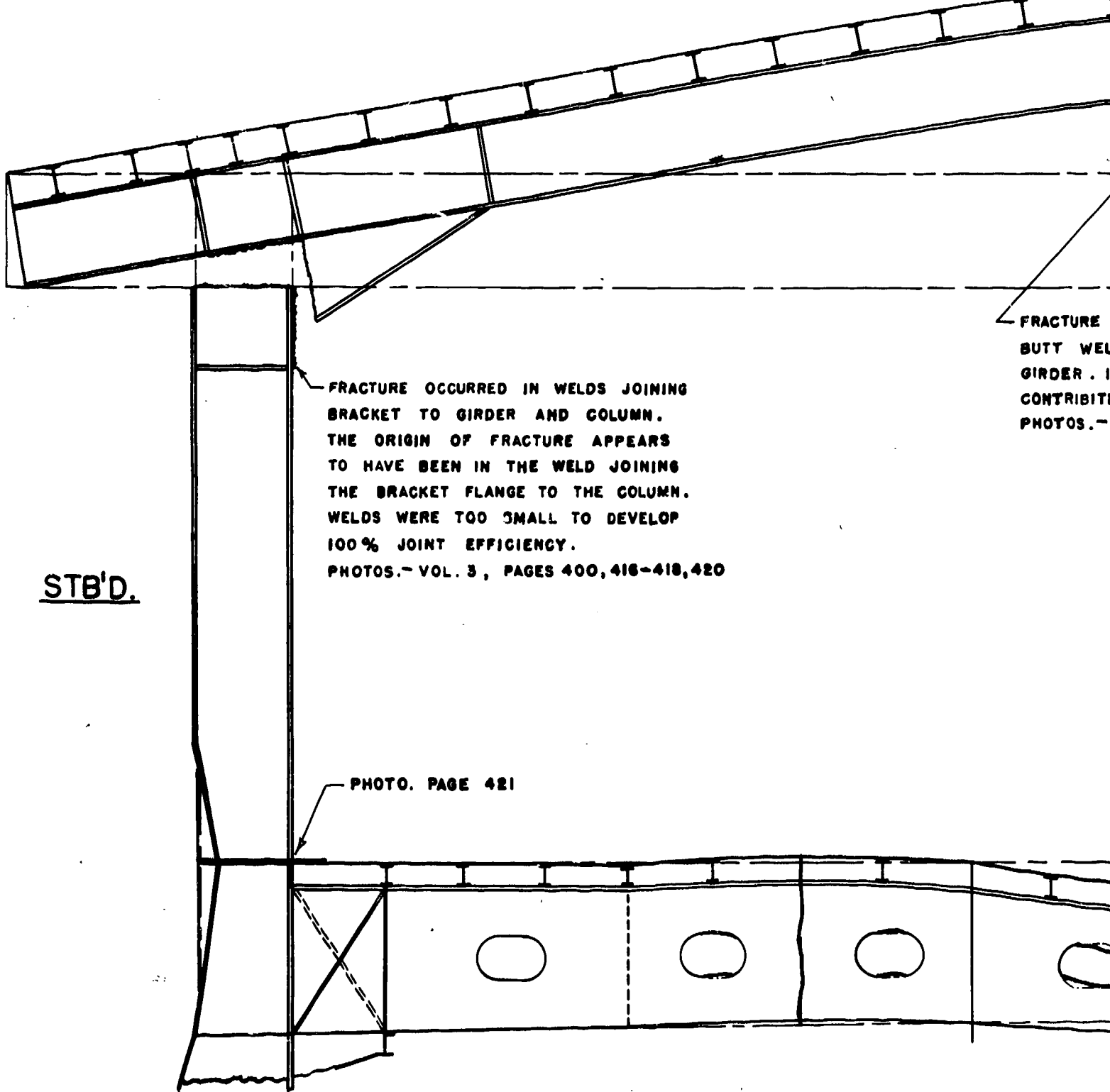

STB'D.

FRACTURE OCCURRED IN WELDS JOINING BRACKET TO GIRDER AND COLUMN. THE ORIGIN OF FRACTURE APPEARS TO HAVE BEEN IN THE WELD JOINING THE BRACKET FLANGE TO THE COLUMN. WELDS WERE TOO SMALL TO DEVELOP 100% JOINT EFFICIENCY. PHOTOS.- VOL. 3, PAGES 400, 416-418, 420

PHOTO. PAGE 421

FRACTURE
BUTT WEL
GIRDER . I
CONTRIBUT
PHOTOS.-

TRANSVERSE
LOC

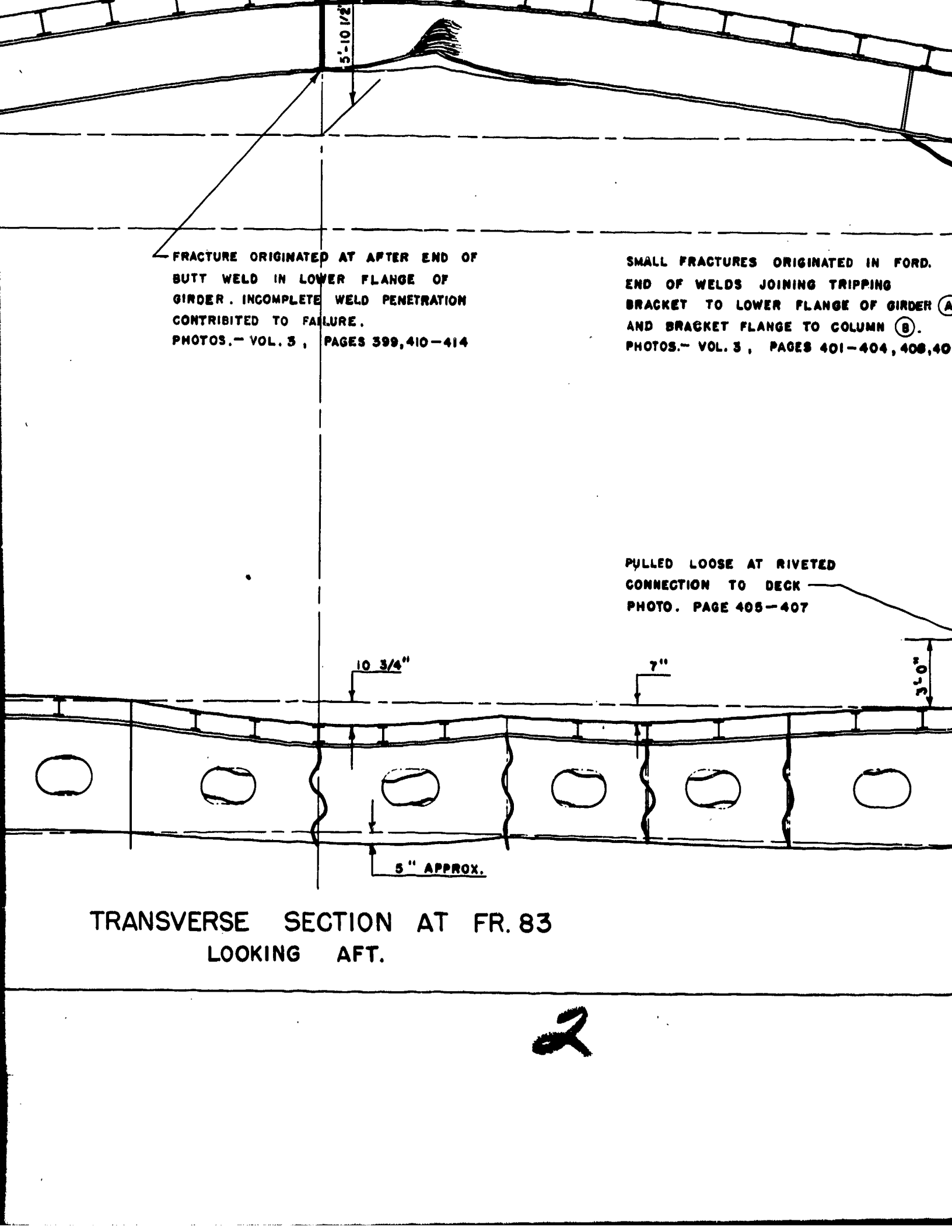

FRACTURE ORIGINATED AT AFTER END OF BUTT WELD IN LOWER FLANGE OF GIRDER. INCOMPLETE WELD PENETRATION CONTRIBUTED TO FAILURE.
PHOTOS.- VOL. 3 , PAGES 399,410-414

SMALL FRACTURES ORIGINATED IN FORD. END OF WELDS JOINING TRIPPING BRACKET TO LOWER FLANGE OF GIRDER (A) AND BRACKET FLANGE TO COLUMN (B).
PHOTOS.- VOL. 3 , PAGES 401-404, 408,40

PULLED LOOSE AT RIVETED CONNECTION TO DECK
PHOTO. PAGE 405-407

10 3/4"

7"

3'-0"

5" APPROX.

TRANSVERSE SECTION AT FR. 83
LOOKING AFT.

2

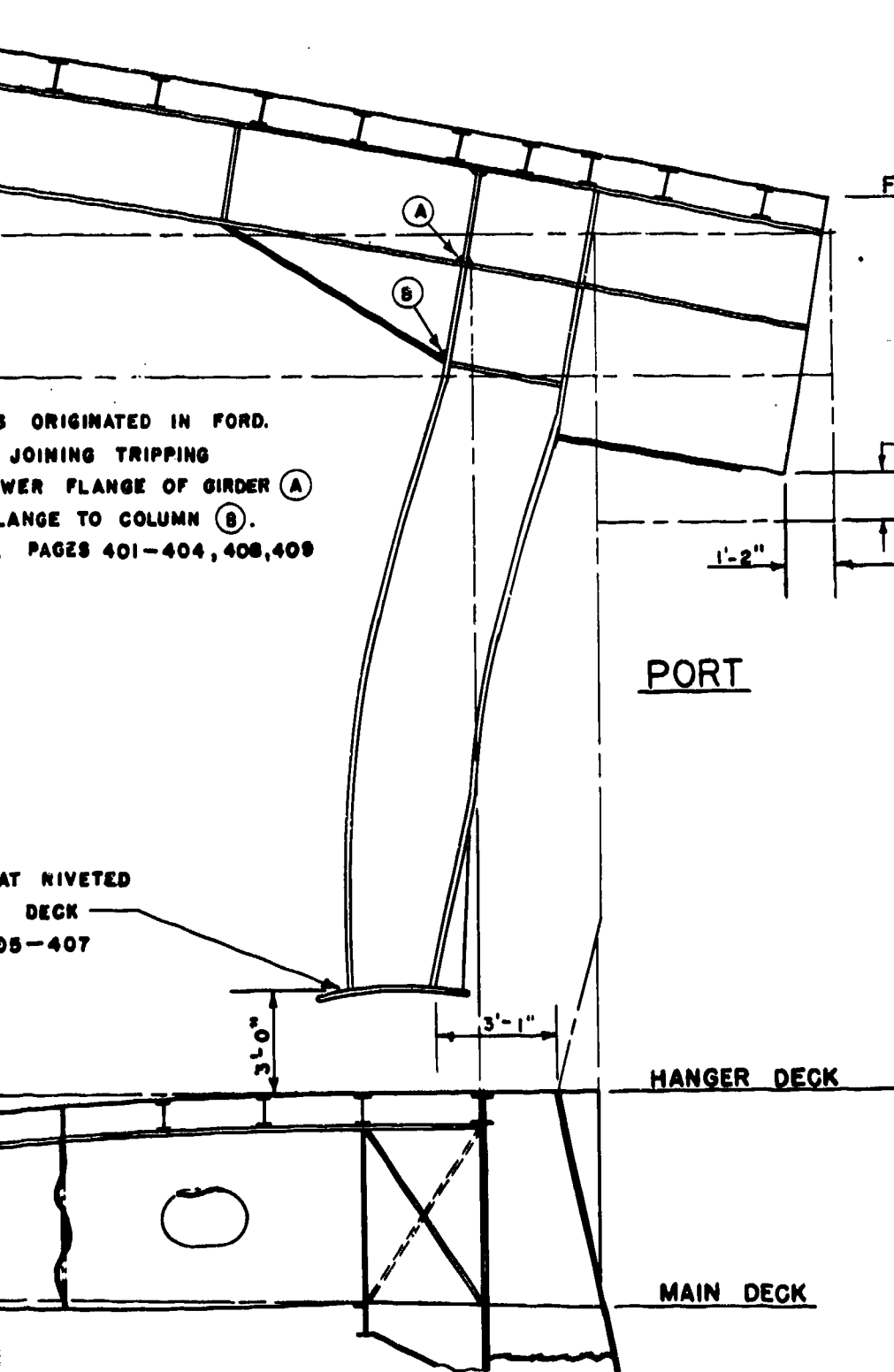

ORIGINATED IN FORD.
 JOINING TRIPPING
 LOWER FLANGE OF GIRDER (A)
 FLANGE TO COLUMN (B).
 PAGES 401-404, 408, 409

AT RIVETED
 DECK
 05-407

FLIGHT DECK

PORT

HANGER DECK

MAIN DECK

----- BEFORE TEST
 _____ AFTER TEST

SECRET

PAGE 216 OF 280

NAVY DEPT.

BUREAU OF

FLIGHT & HANGER DK. DEFLE
 TRANSVERSE SECTION, FRAM

TEST A

U.S.S. INDEPENDENCE

PLATE NO.14

3

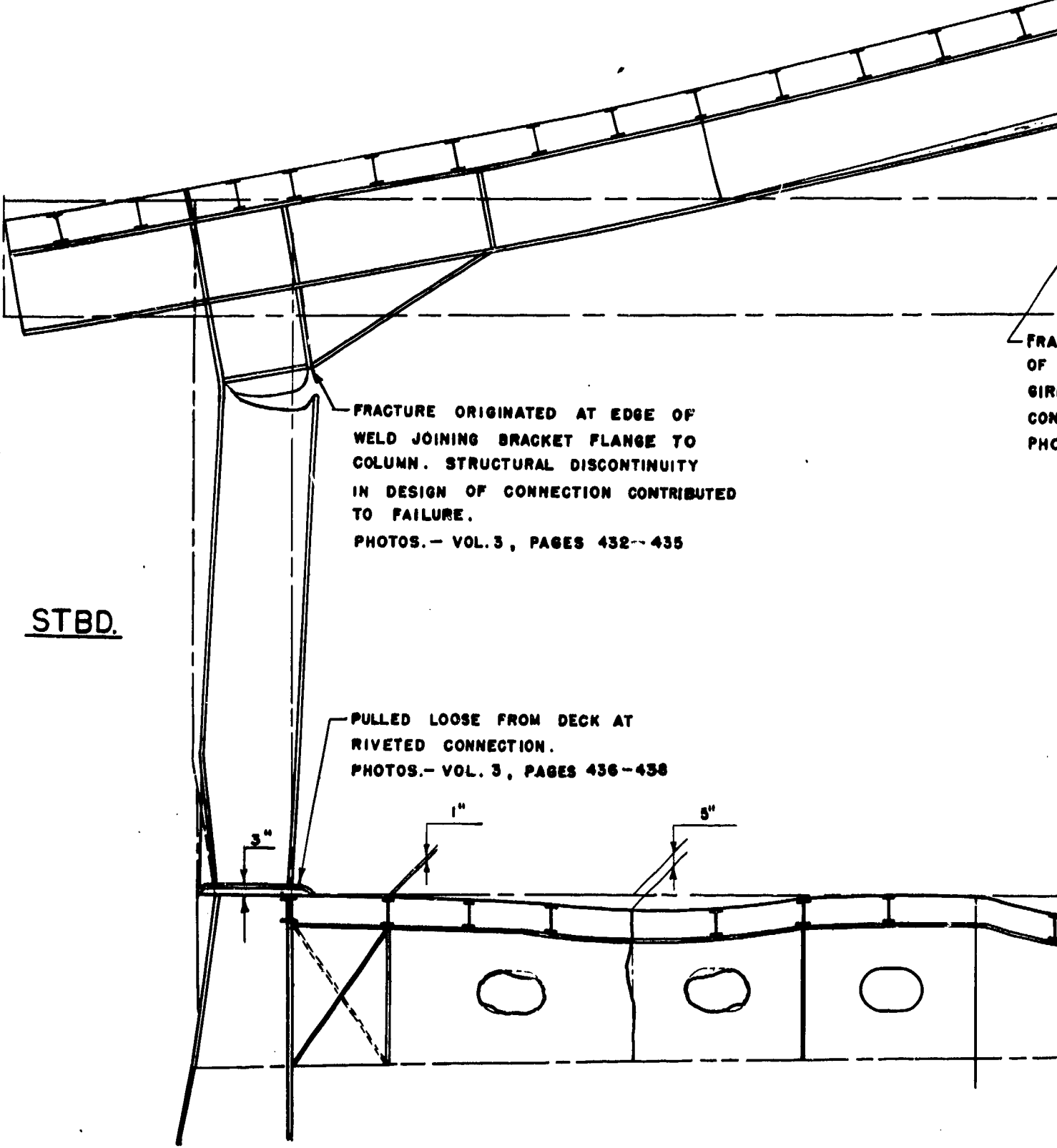

FRA
OF
GIR
CON
PHO

FRACTURE ORIGINATED AT EDGE OF
WELD JOINING BRACKET FLANGE TO
COLUMN. STRUCTURAL DISCONTINUITY
IN DESIGN OF CONNECTION CONTRIBUTED
TO FAILURE.
PHOTOS.- VOL. 3 , PAGES 432--435

STBD.

PULLED LOOSE FROM DECK AT
RIVETED CONNECTION.
PHOTOS.- VOL. 3 , PAGES 436-438

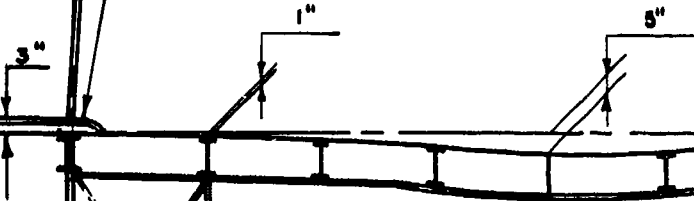

TRANSVE

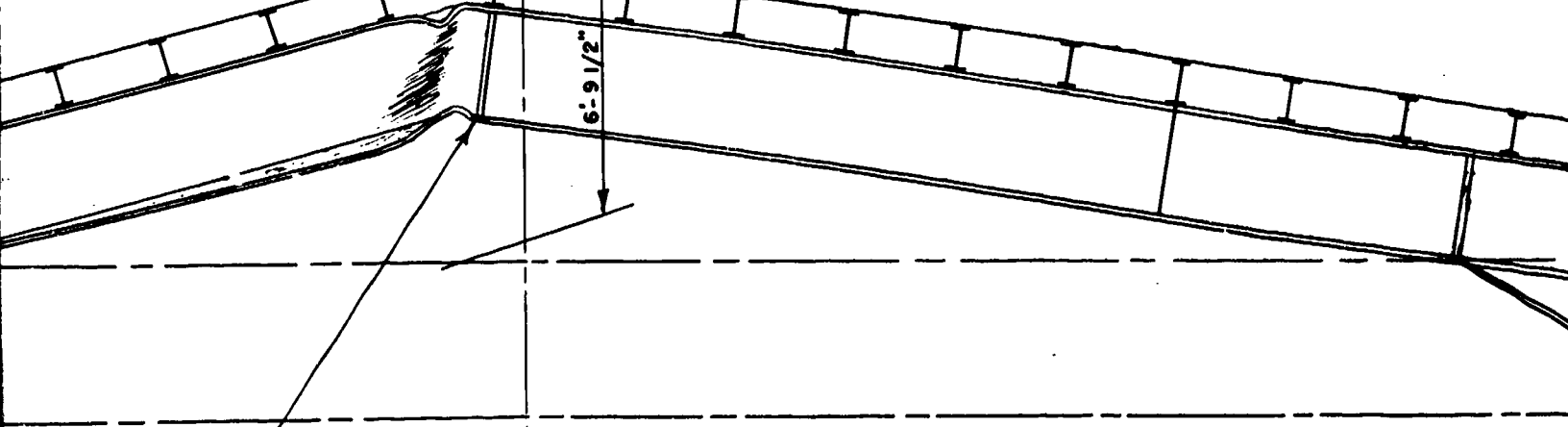

FRACTURE ORIGINATED AT FORWARD END OF BUTT WELD IN LOWER FLANGE OF GIRDER. INCOMPLETE WELD PENETRATION CONTRIBUTED TO FAILURE.

PHOTOS. - VOL. 3, PAGES 427-431

PHOTO. PAGE 425

PULLED LOOSE FROM DECK AT RIVETED CONNECTION.
PHOTOS. - VOL. 3, PAGES 422-424

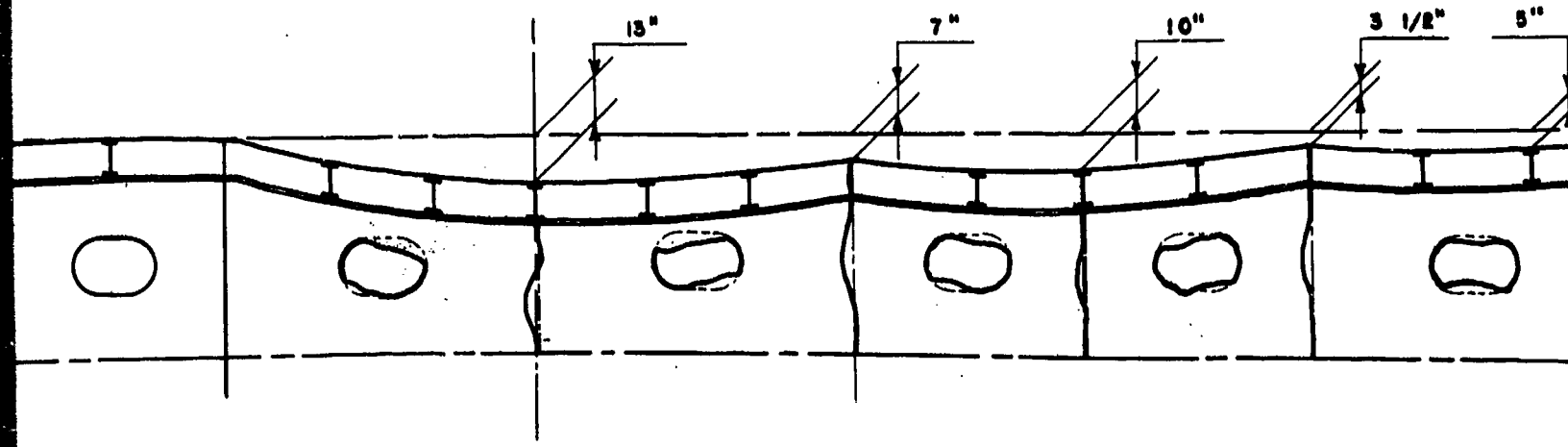

TRANSVERSE SECTION AT FR. 86
LOOKING AFT.

2

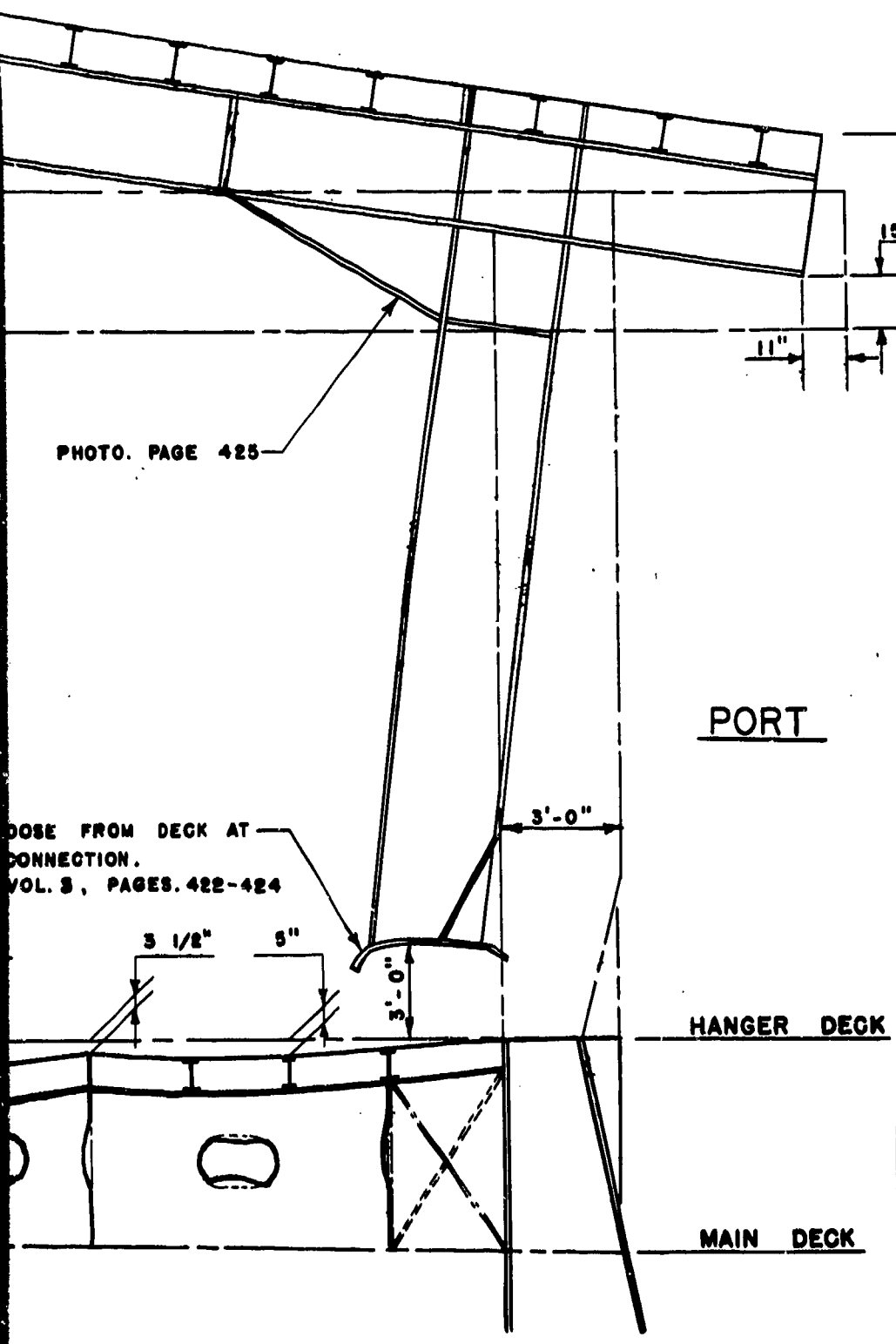

PHOTO. PAGE 425

DOSE FROM DECK AT CONNECTION.
VOL. 3, PAGES. 422-424

FLIGHT DECK

15 1/2"

11"

PORT

3'-0"

3'-0"

3 1/2"

5"

HANGER DECK

MAIN DECK

_____ BEFORE TEST
_____ AFTER TEST

SECRET

PAGE 217 OF 280

NAVY DEPT.

BUREAU OF

FLIGHT & HANGER DK. DEFLECTION
TRANSVERSE SECTION, FRAME

TEST A

U.S.S. INDEPENDENCE

PLATE NO. 15

3

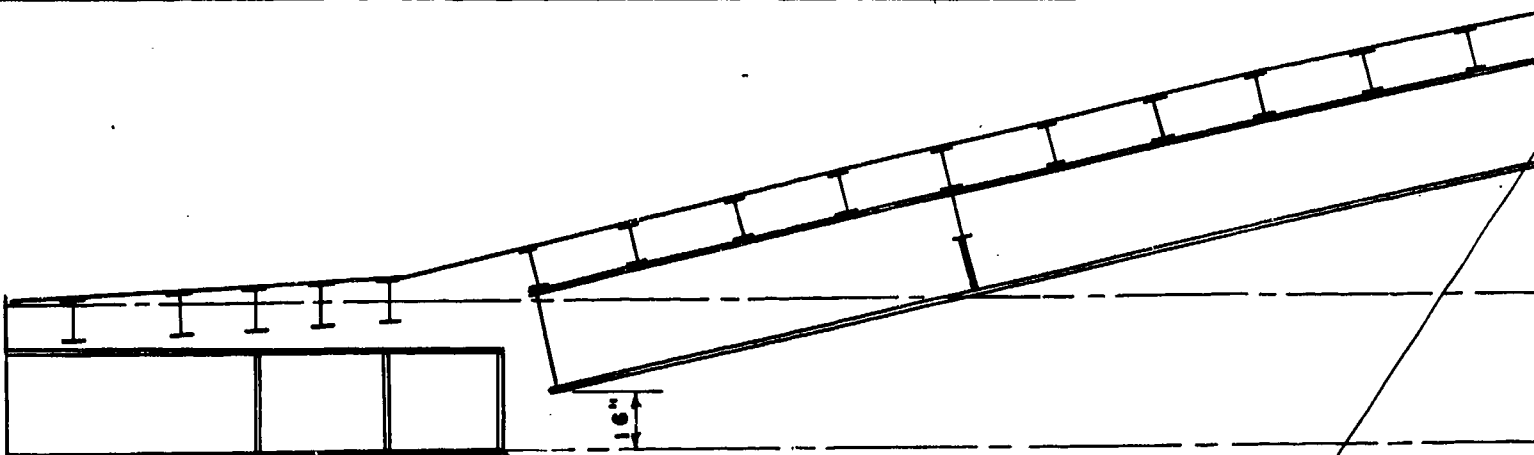

FRACTURE ORIGINATED AT UPPER EDGE OF WELD JOINING BRACKET FLANGE TO GIRDER. WELDS TOO SMALL TO DEVELOP 100% JOINT EFFICIENCY.
PHOTOS. - VOL. 3, PAGES 451-453

FRACTURE ORIGINATED AT UPPER EDGE OF WELD BETWEEN GIRDER AND LONGITUDINAL BRACKET.
PHOTOS. - VOL. 3, PAGES 451-453

STBD.

PHOTO. PAGE 454

1"
2"

TRANSVERSE
LOOK

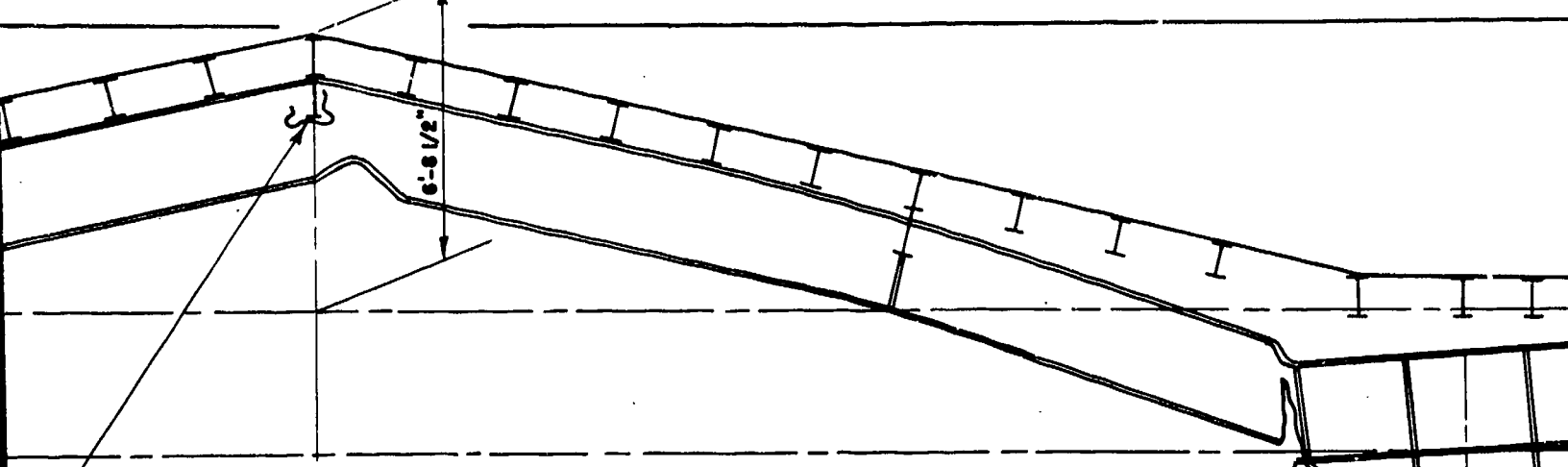

FRACTURE ORIGINATED AT FORWARD END OF WELD BETWEEN TRIPPING BRACKET AND LONGITUDINAL BRACKET.
 PHOTOS.— VOL. 3, PAGES 448—450

FRACTURE ORIGINATED AT UPPER EDGE OF WELD JOINING BRACKET FLANGE TO GIRDER. STRUCTURAL DISCONTINUITY IN DESIGN OF CONNECTION CONTRIBUTED TO FAILURE.
 PHOTOS.— VOL. 3, PAGES 445—447

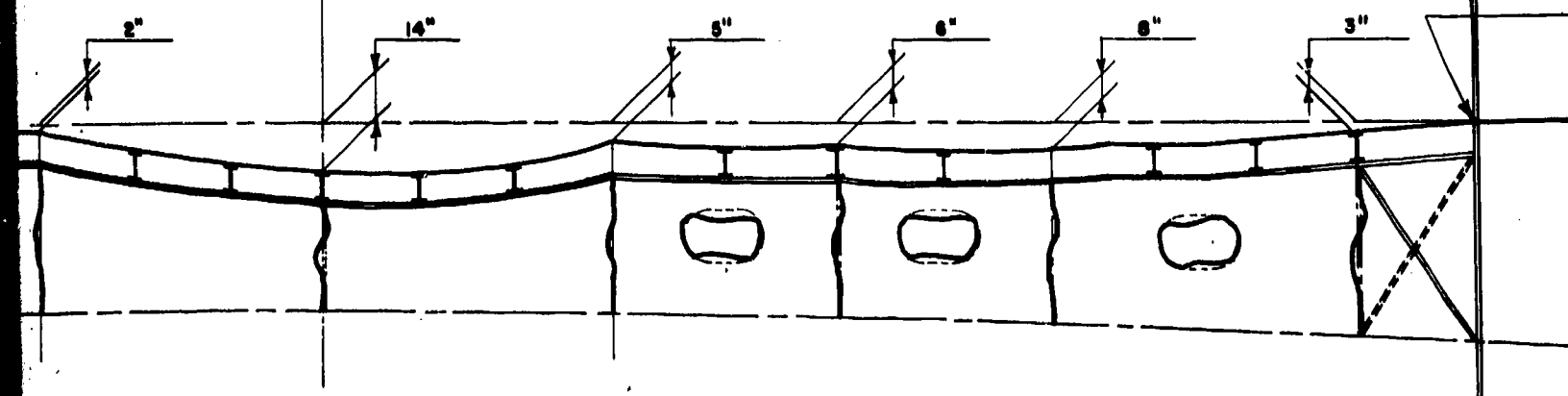

TRANSVERSE SECTION AT FR. 89
 LOOKING AFT

2

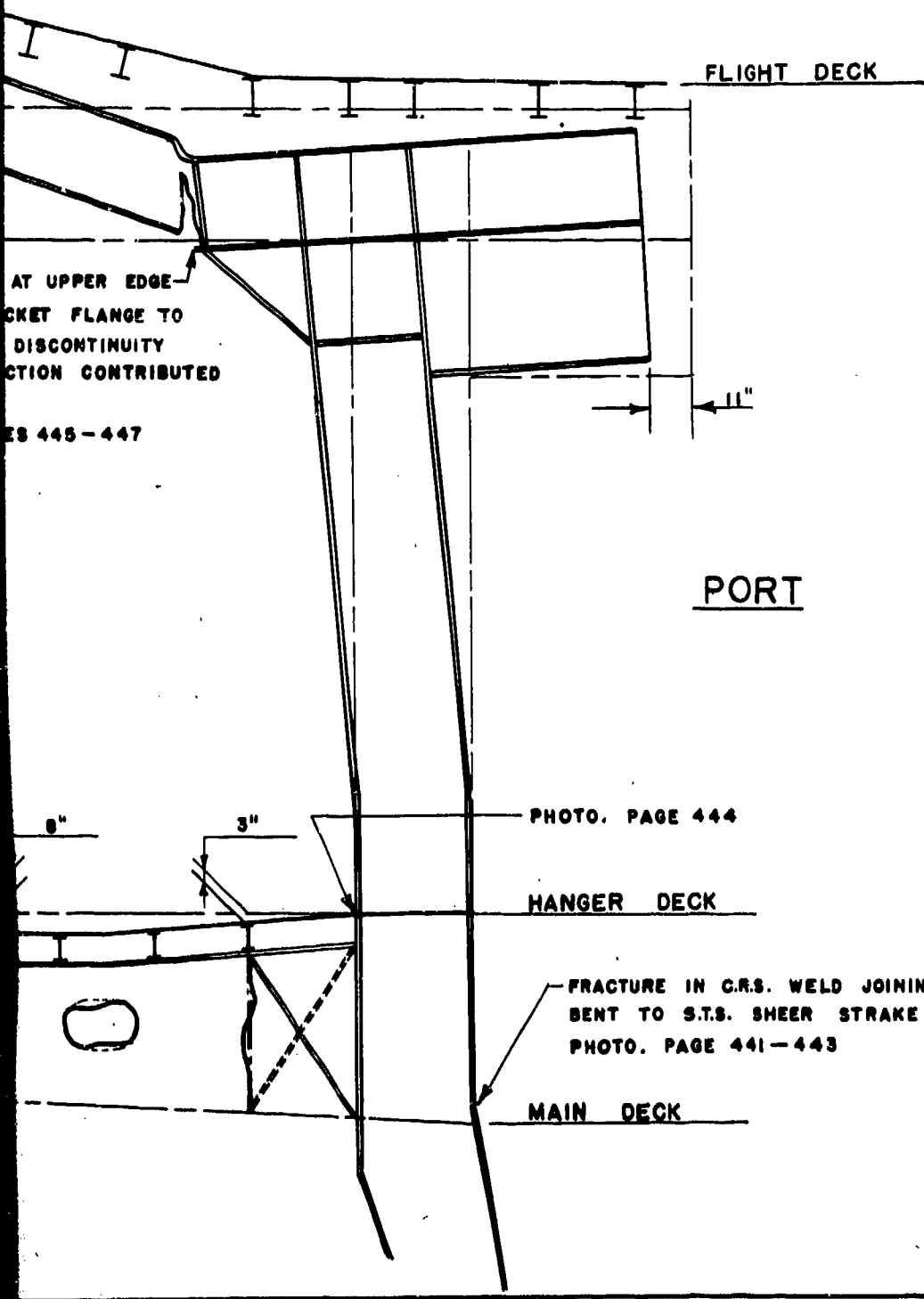

----- BEFORE TEST
 ----- AFTER TEST

SECRET PAGE 218 OF 280
 NAVY DEPT. BUREAU OF
 FLIGHT & HANGER DK. DEFLE
 TRANSVERSE SECTION, FRAM
 TEST A
 U.S.S. INDEPENDENCE

PLATE NO. 16

3

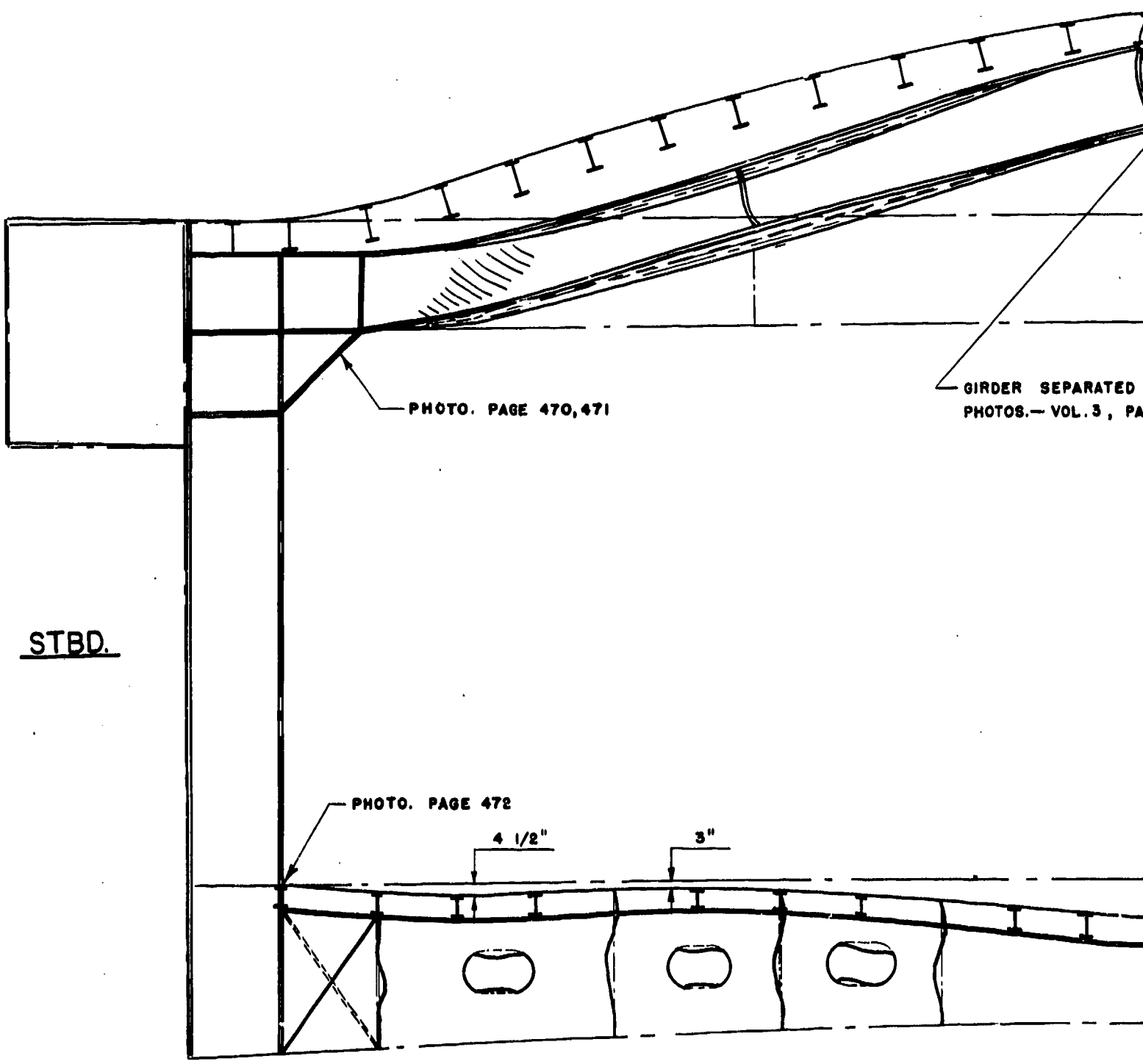

PHOTO. PAGE 470, 471

GIRDER SEPARATED
PHOTOS.— VOL. 3, PA

STBD.

PHOTO. PAGE 472

4 1/2"

3"

TRANSVERSE S
LOOKING

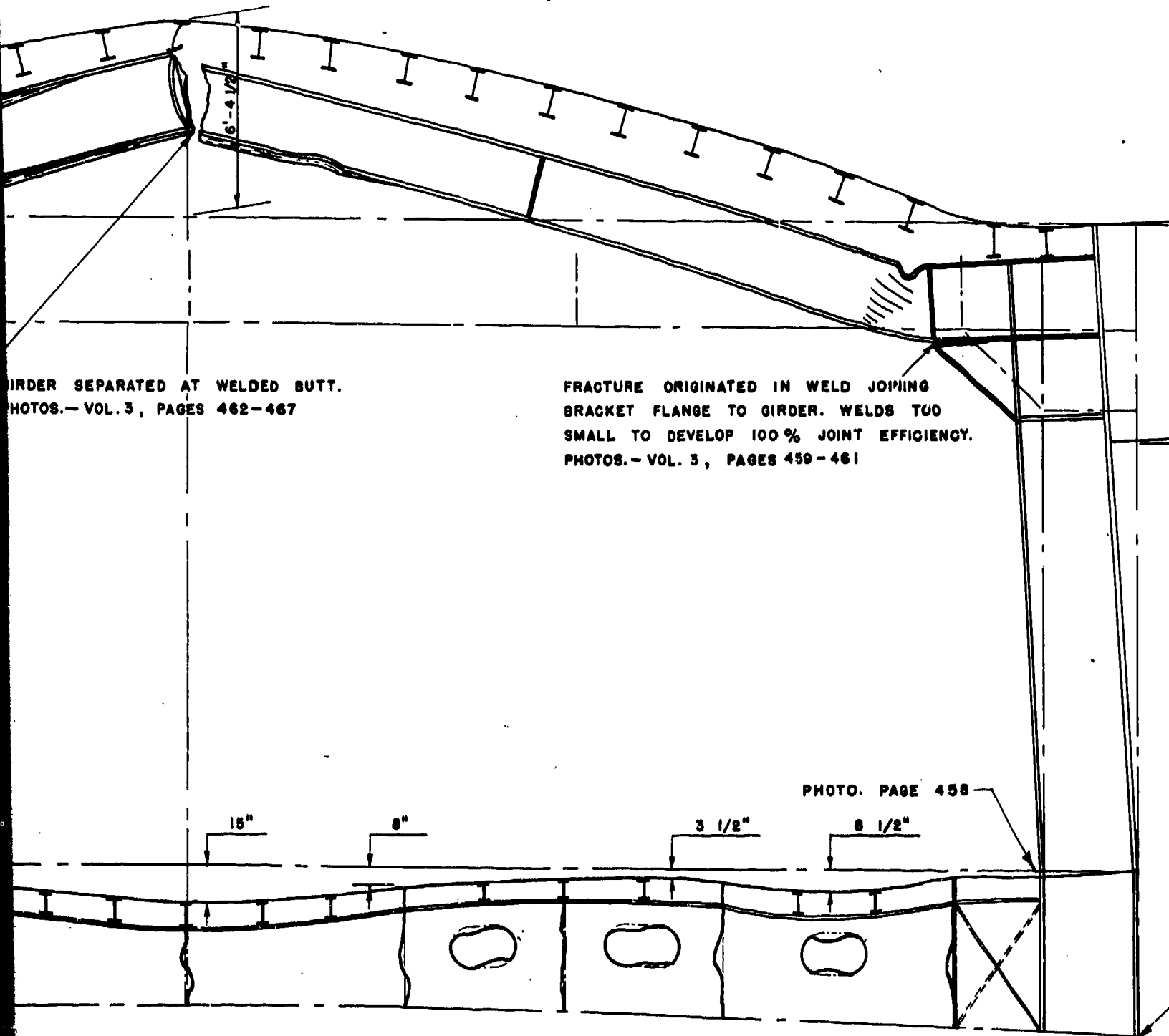

TRANSVERSE SECTION AT FR.92
LOOKING AFT.

2

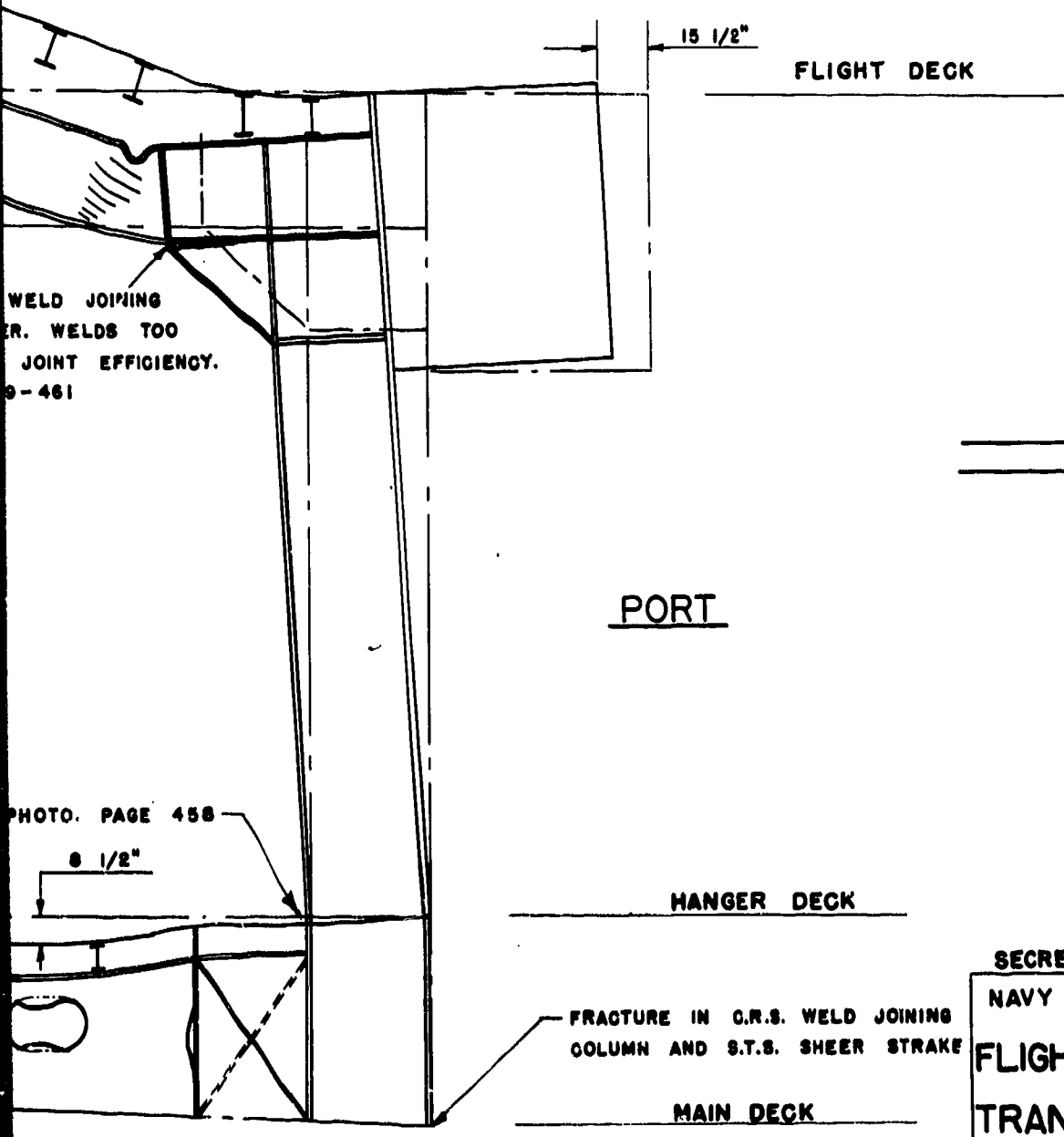

_____ BEFORE TEST
 _____ AFTER TEST

PORT

HANGER DECK

MAIN DECK

SECRET PAGE 219 OF 219
 NAVY DEPT. BUREAU OF NAVAL ARCHITECTURE
 FLIGHT & HANGER DK. DEFLECTION TEST
 TRANSVERSE SECTION, FRAMING
 TEST A
 U.S.S. INDEPENDENCE

PLATE NO. 17

3

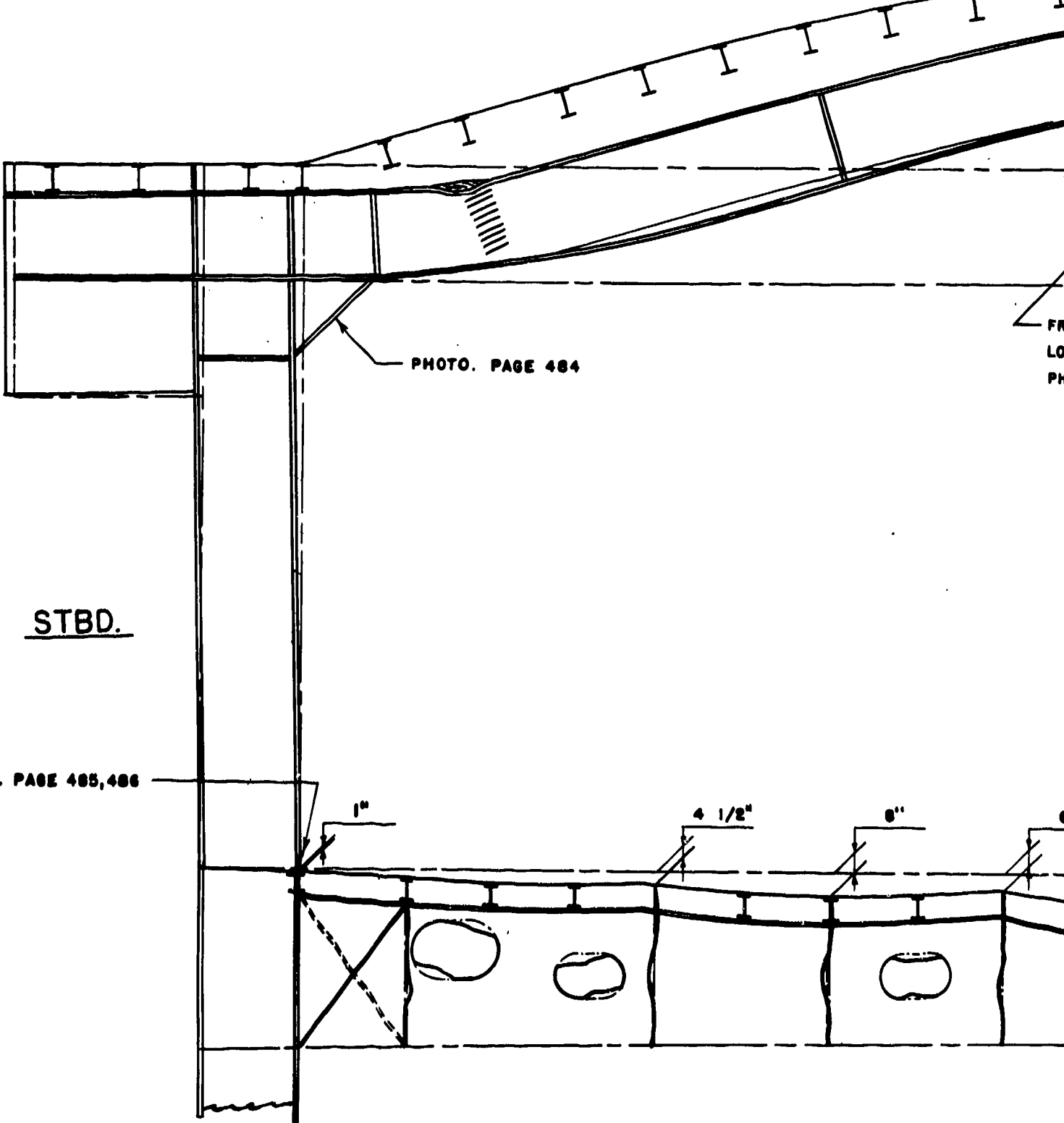

STBD.

PHOTO. PAGE 484

PHOTO. PAGE 485, 486

1"

4 1/2"

8"

TRANSV

1

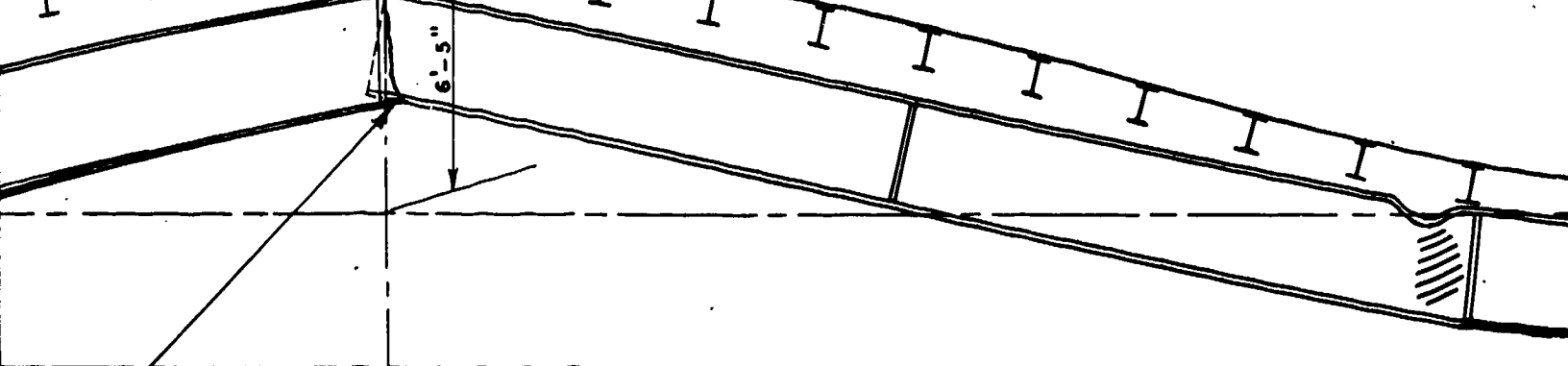

FRACTURE ORIGINATED IN BUTT WELD IN
 LOWER FLANGE OF GIRDER.
 PHOTOS.- VOL. 3, PAGES 475-483

FRACTURE ORIGINATED IN WELD JOINING
 BRACKET FLANGE TO TRANSVERSE GIRDER.
 WELDS TOO SMALL TO DEVELOP 100%
 JOINT EFFICIENCY.
 PHOTOS.- VOL. 3, PAGES 473, 474

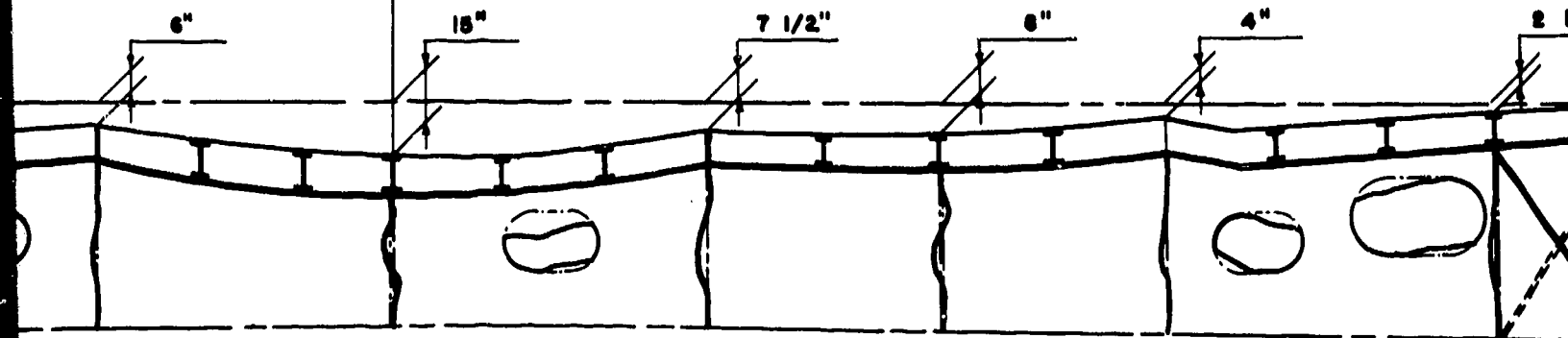

TRANSVERSE SECTION AT FR. 95
 LOOKING AFT

2

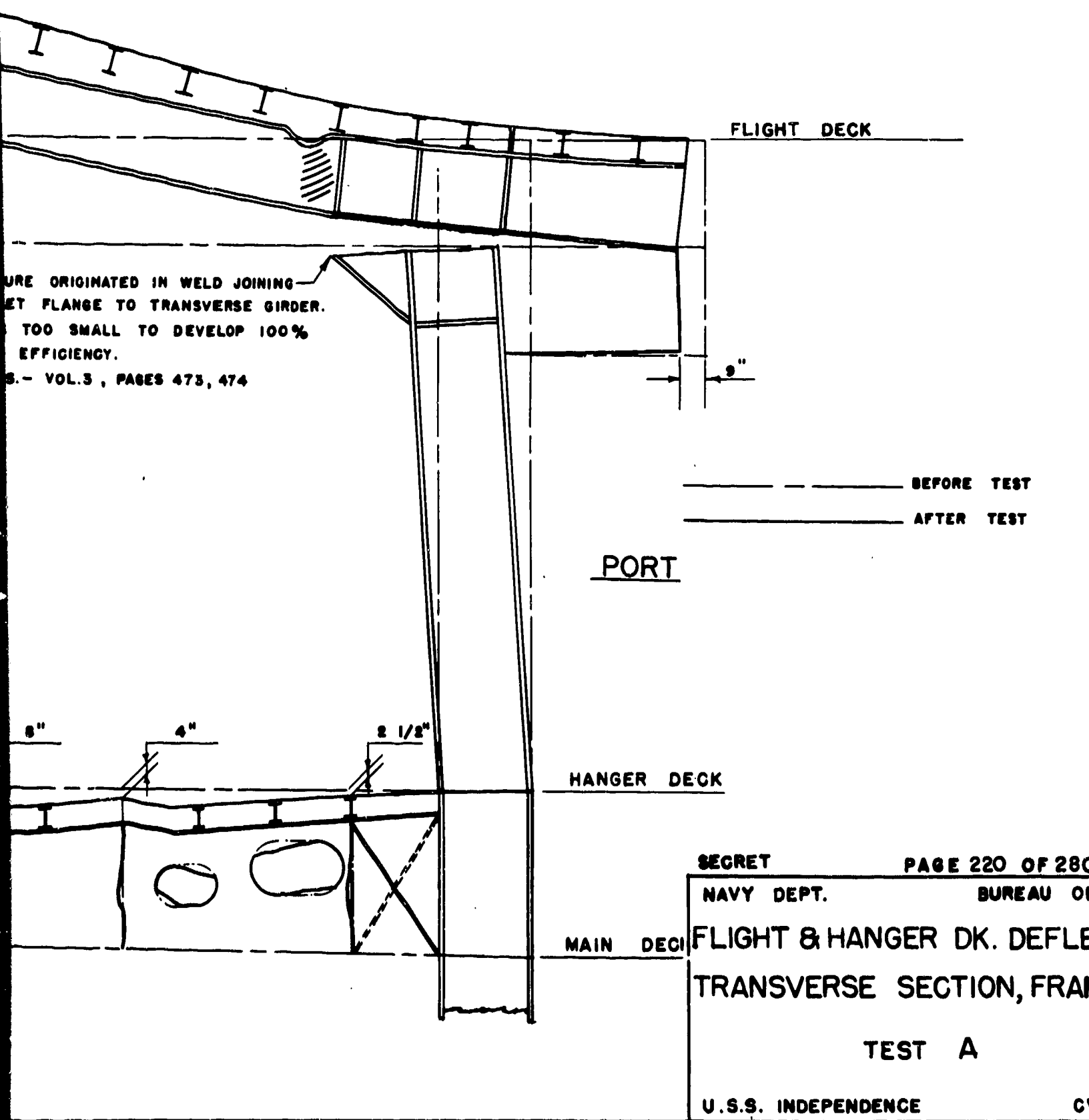
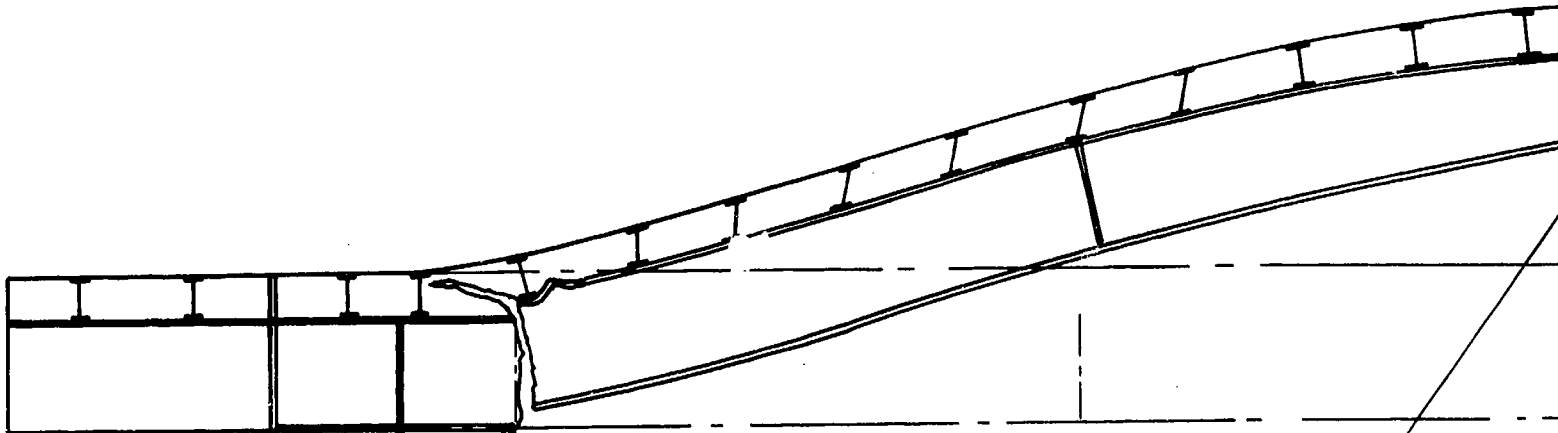

PLATE NO. 18

3



FRACTURE ORIGINATED AT UPPER EDGE OF WELD JOINING BRACKET FLANGE TO GIRDER. STRUCTURAL DISCONTINUITY IN DESIGN OF CONNECTION CONTRIBUTED TO FAILURE.

PHOTOS. - VOL. 3, PAGE 496

FRACTURE OF
IN LOWER P
PHOTOS. - VOL

STBD.

PHOTO. PAGE 498

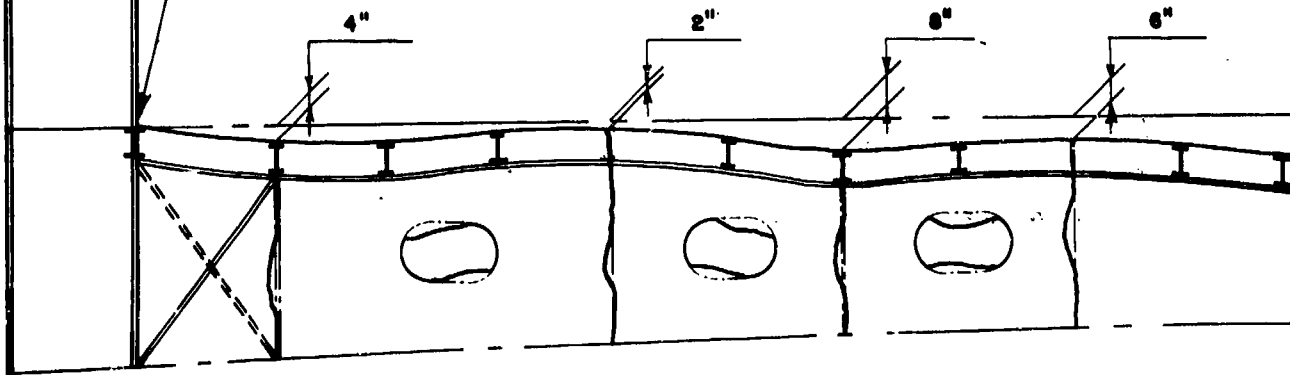

TRANSVERSE
LOOK

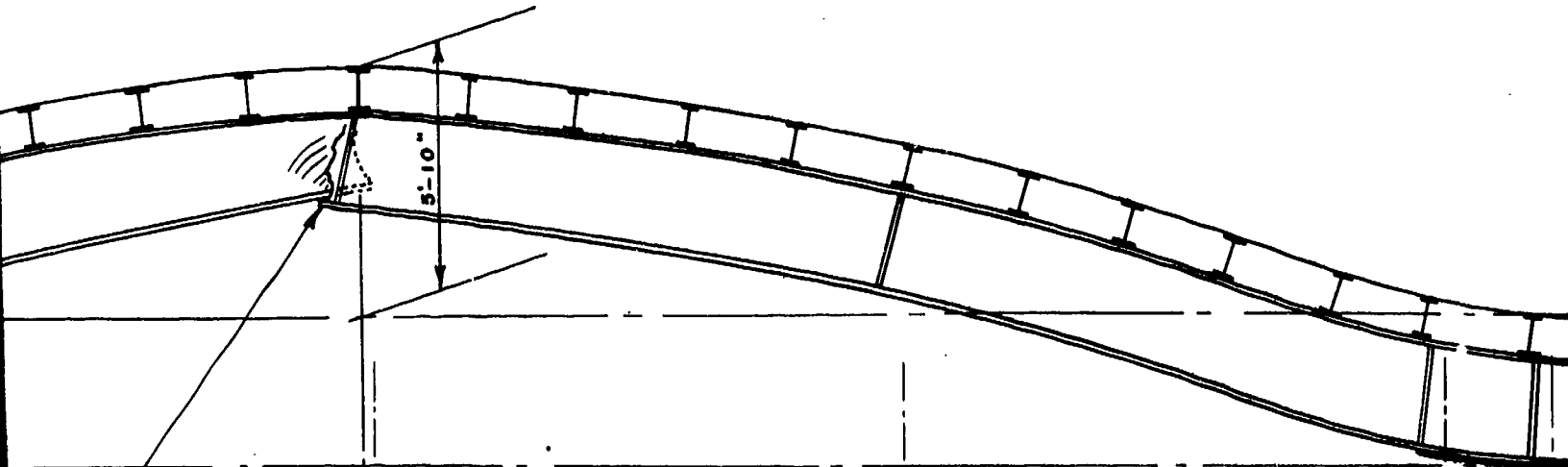

FRACTURE ORIGINATED AT BUTT WELD
 IN LOWER FLANGE OF GIRDER.
 PHOTOS.— VOL. 3, PAGES 492-495

FRACTURE ORIGINATED IN WELD JOINING
 BRACKET FLANGE AND GIRDER.
 WELDS TOO SMALL TO DEVELOP 100%
 JOINT EFFICIENCY.
 PHOTOS.— VOL. 3, PAGES 489-491

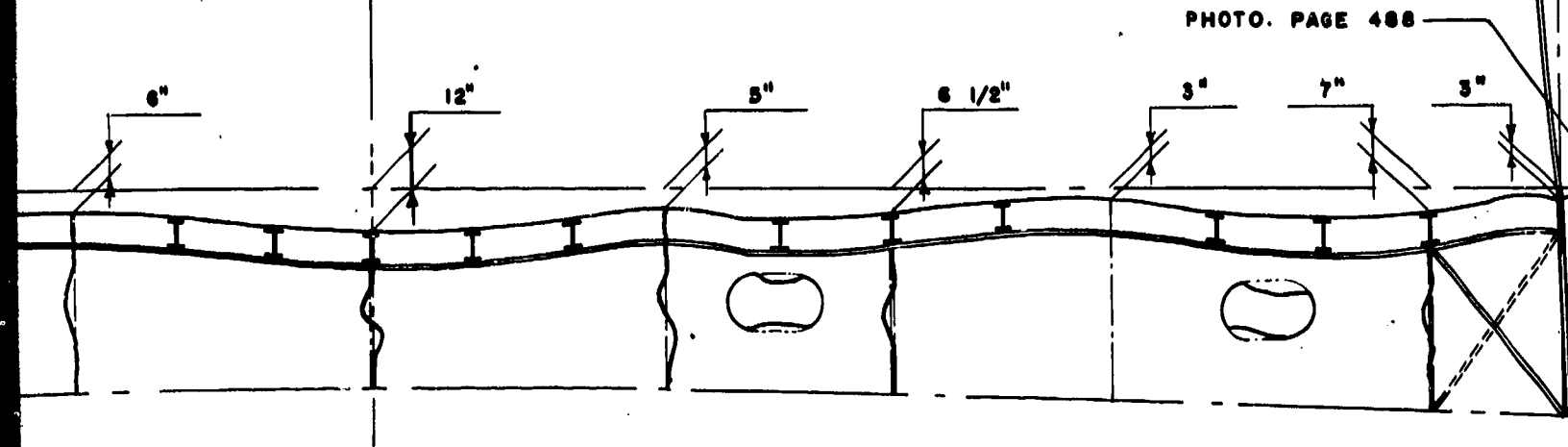

TRANSVERSE SECTION AT FR. 98
 LOOKING AFT

2

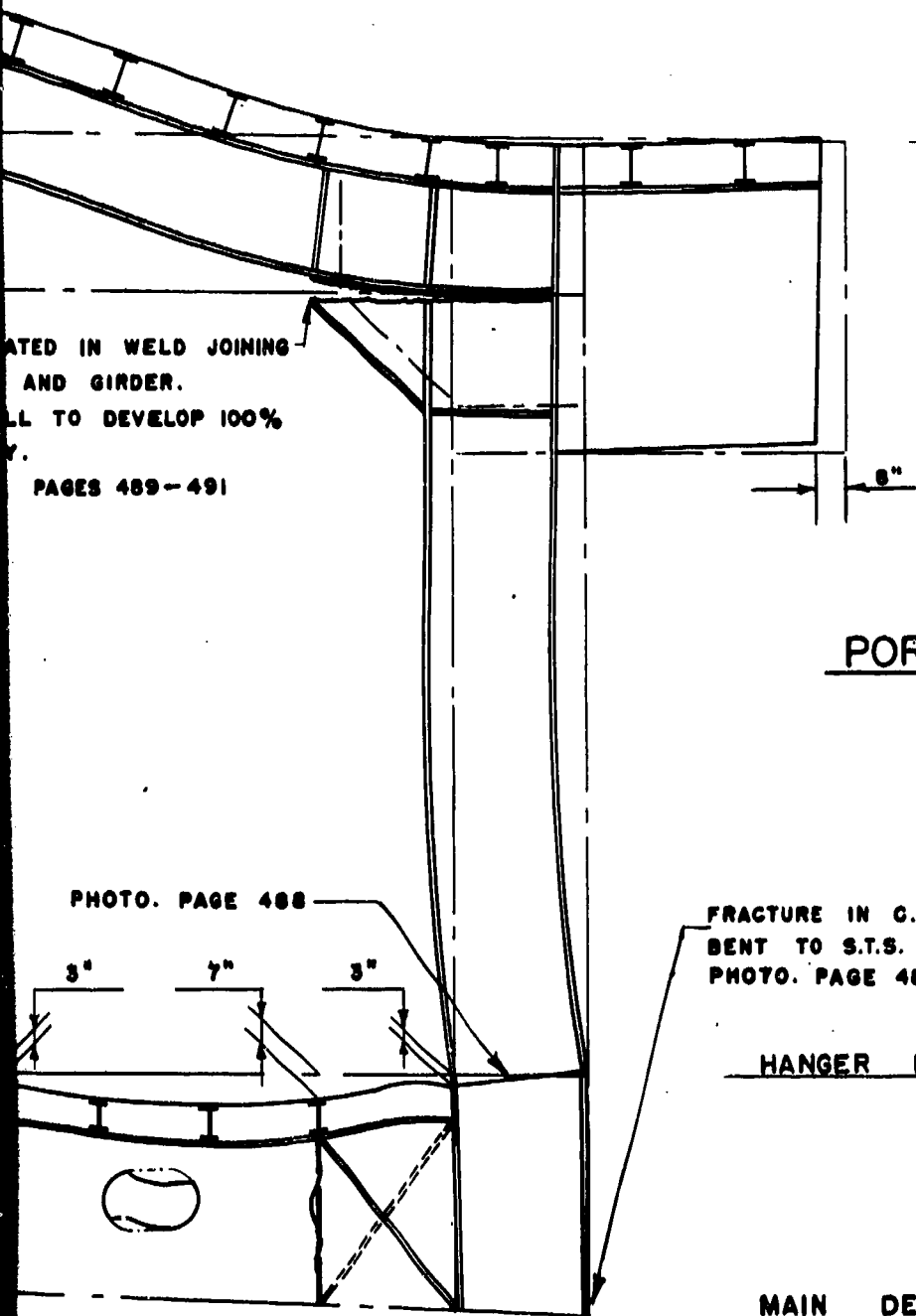

FLIGHT DECK

BEFORE TEST

AFTER TEST

PORT

FRACTURE IN C.R.S. WELD JOINING
BENT TO S.T.S. SHEER STRAKE.
PHOTO. PAGE 487

HANGER DECK

MAIN DECK

SECRET

PAGE 221 OF 280

NAVY DEPT.

BUREAU OF

FLIGHT & HANGER DK. DEFLECT

TRANSVERSE SECTION, FRAME

TEST A

U.S.S. INDEPENDENCE

CVL

PLATE NO. 19

3

ATED IN WELD JOINING
AND GIRDER.
L TO DEVELOP 100%

PAGES 489-491

PHOTO. PAGE 488

3" 7" 3"

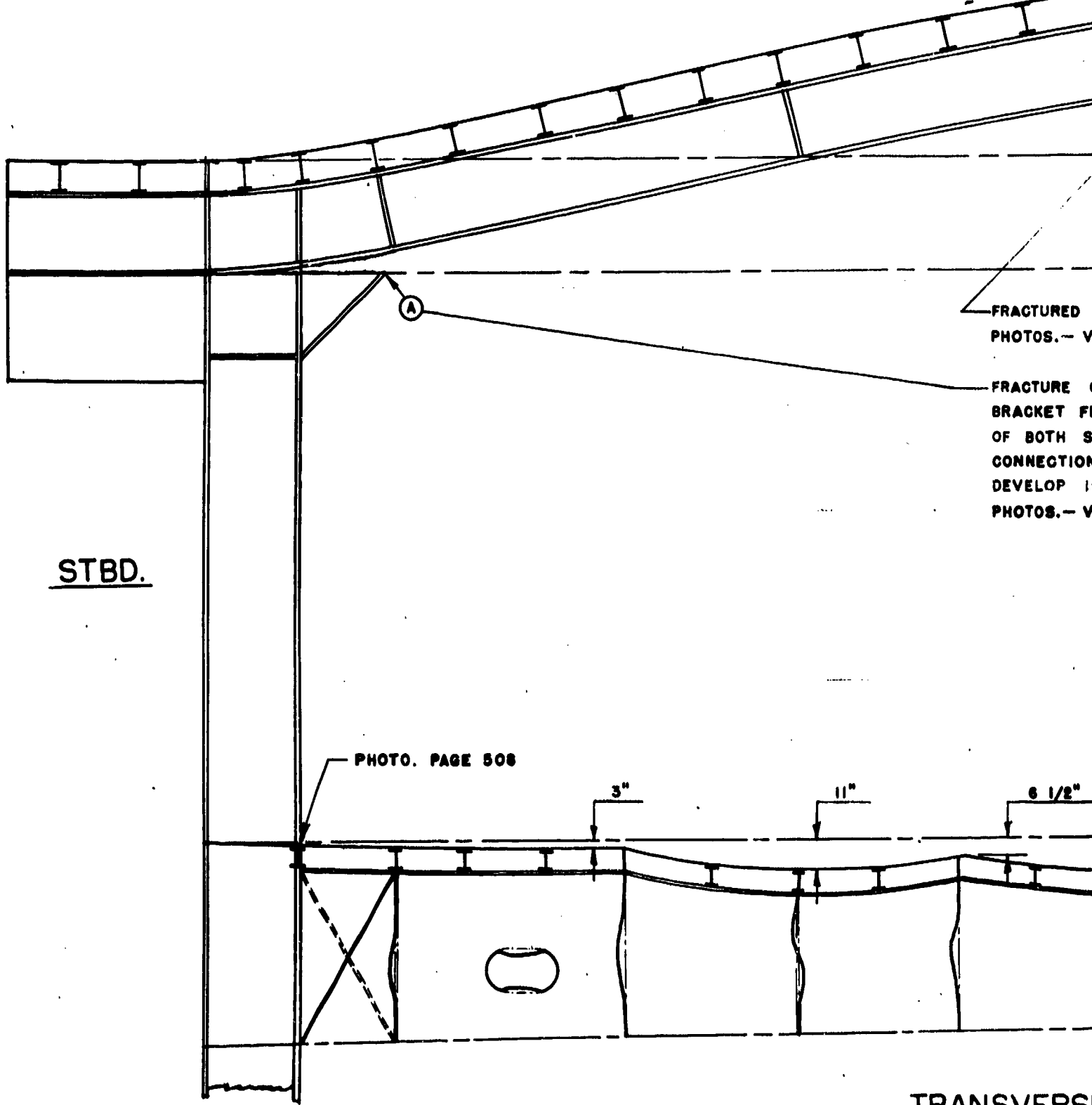

STBD.

PHOTO. PAGE 508

3"

11"

6 1/2"

TRANSVERS
LOC

FRACTURED
PHOTOS. - V

FRACTURE
BRACKET F
OF BOTH S
CONNECTION
DEVELOP I
PHOTOS. - V

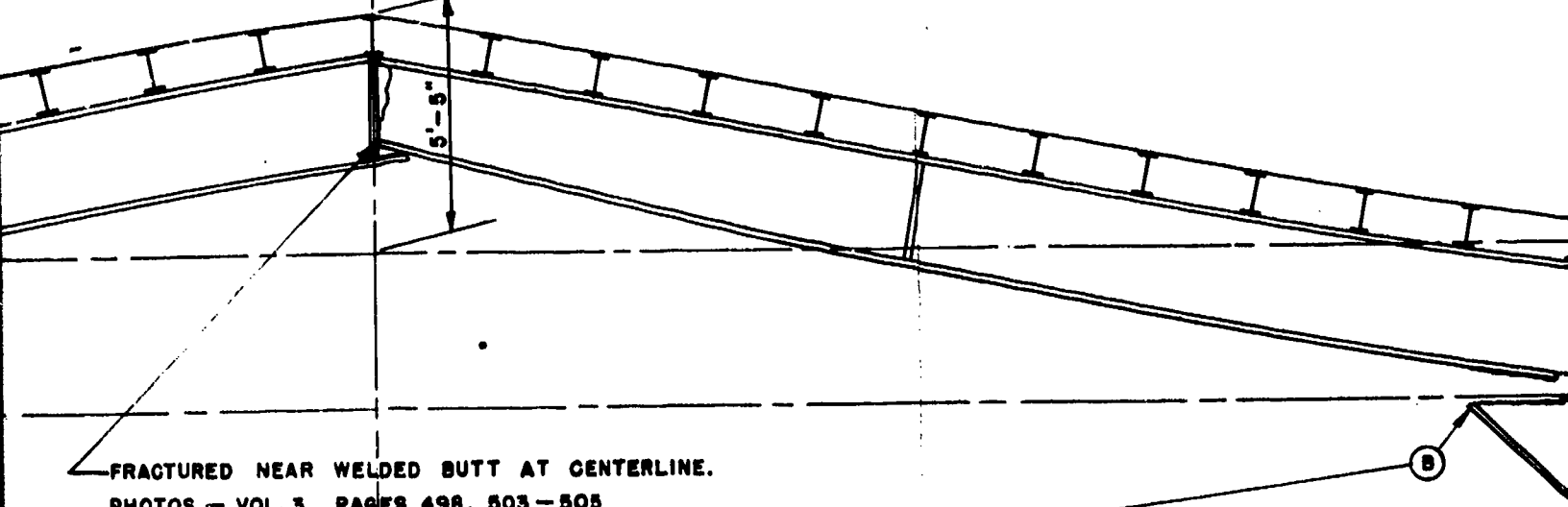

FRACTURED NEAR WELDED BUTT AT CENTERLINE.
 PHOTOS.— VOL. 3 , PAGES 498, 503—505

FRACTURE ORIGINATED IN WELDS JOINING
 BRACKET FLANGE TO GIRDER IN THE CASE
 OF BOTH STBD. (A) AND PORT (B)
 CONNECTIONS. WELDS TOO SMALL TO
 DEVELOP 100% JOINT EFFICIENCY.
 PHOTOS.— VOL. 3 , PAGES (A) 506,507

(B) 500-502

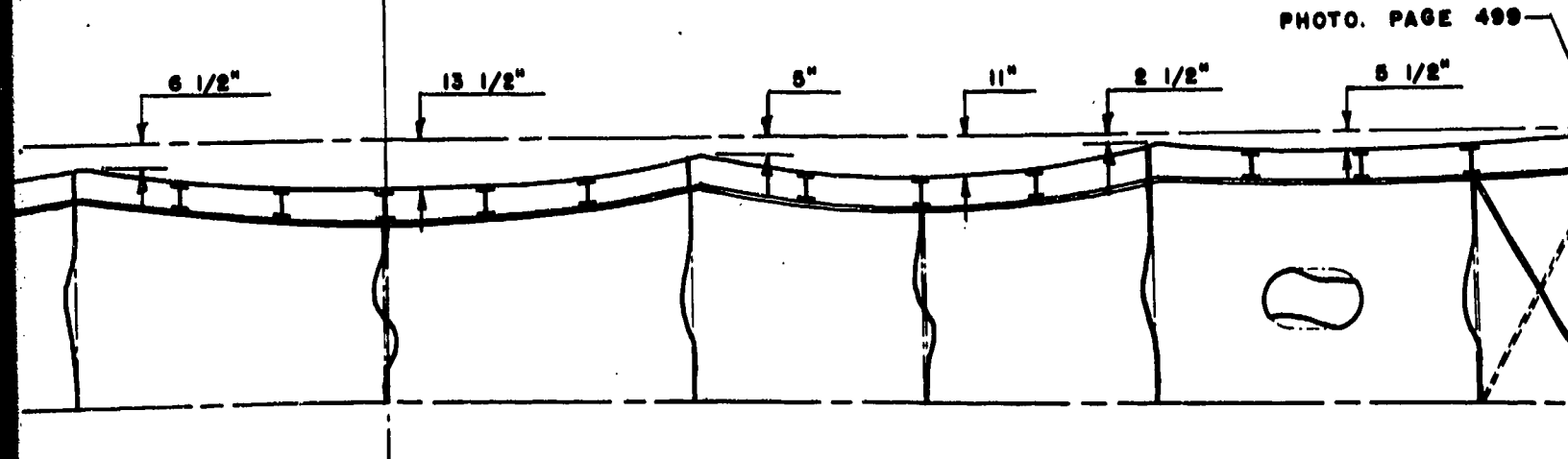
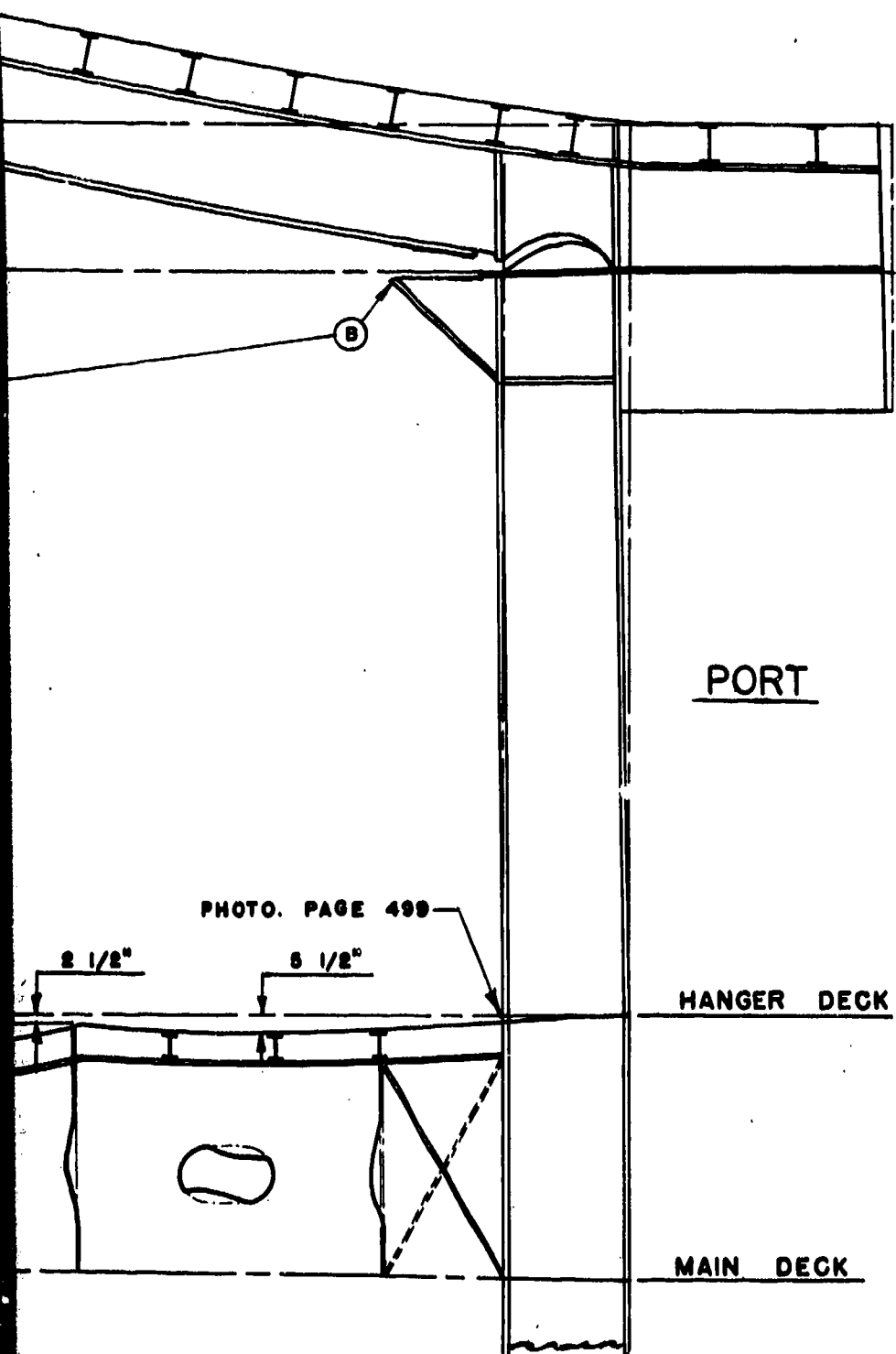

PHOTO. PAGE 499

TRANSVERSE SECTION AT FR.101
 LOOKING AFT

2



FLIGHT DECK

----- BEFORE
 ----- AFTER

PORT

PHOTO. PAGE 499

2 1/2"

5 1/2"

HANGER DECK

MAIN DECK

SECRET

PAGE 222 OF 2

NAVY DEPT.

BUREAU OF

FLIGHT & HANGER DK. DEFL

TRANSVERSE SECTION, FRA

TEST A.

U.S.S. INDEPENDENCE

PLATE NO. 20

3

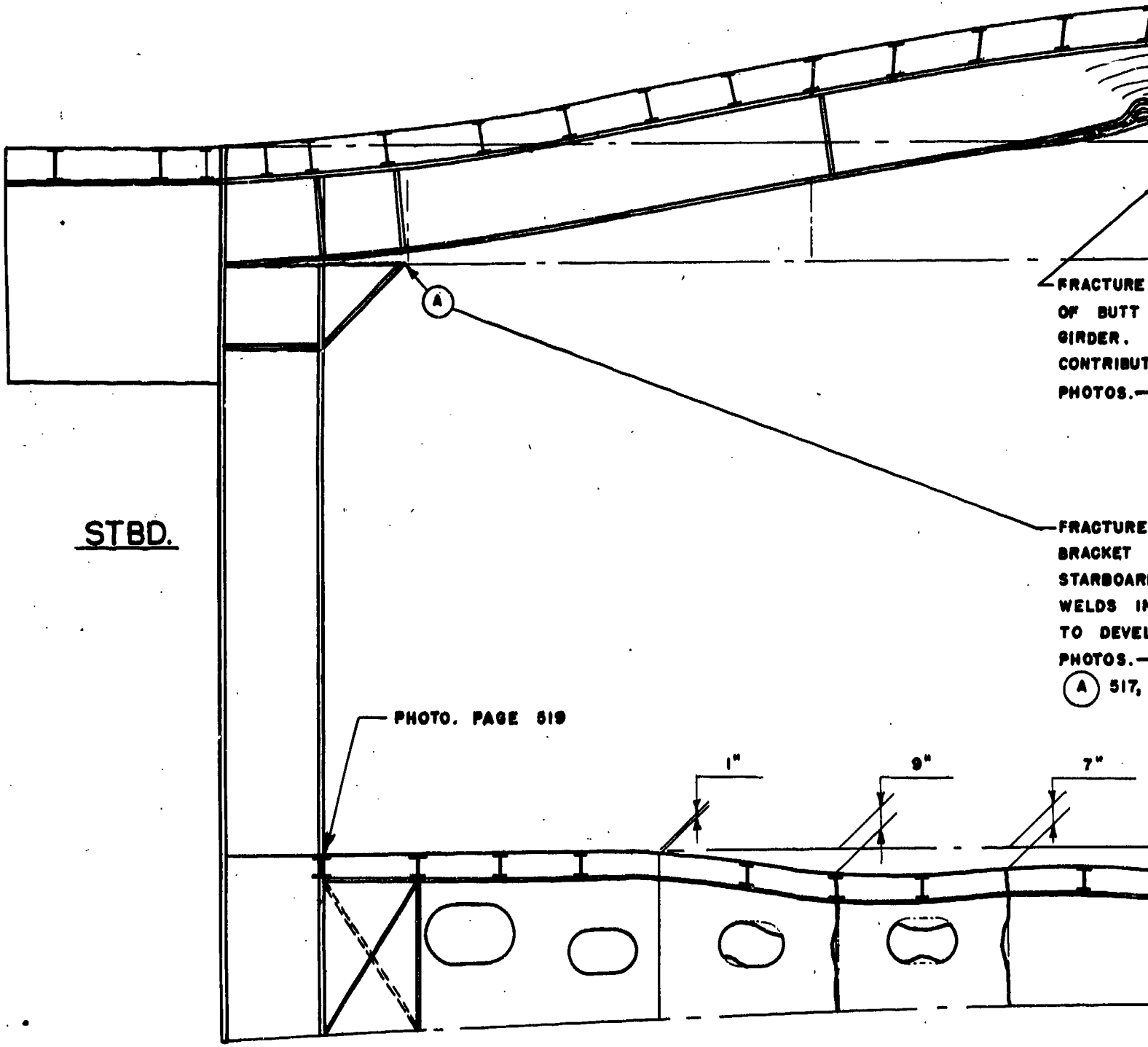

FRACTURE
OF BUTT
GIRDER.
CONTRIBUT
PHOTOS.—

FRACTURE
BRACKET
STARBOARD
WELDS IN
TO DEVEL
PHOTOS.—

(A) 517,

STBD.

PHOTO. PAGE 519

1"

9"

7"

TRANSVERSE
LOC

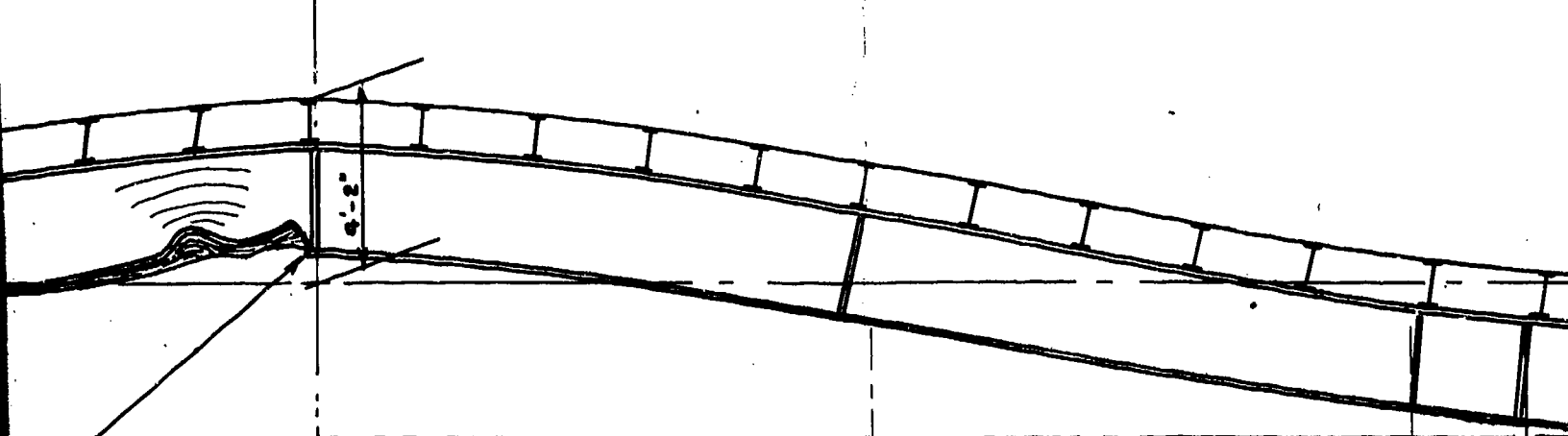

FRACTURE ORIGINATED IN FORWARD END OF BUTT WELD IN LOWER FLANGE OF GIRDER. INCOMPLETE WELD PENETRATION CONTRIBUTED TO FAILURE.

PHOTOS.— VOL. 4, PAGES 513-516

FRACTURE ORIGINATED IN WELDS JOINING BRACKET FLANGE TO GIRDER IN BOTH STARBOARD (A) AND PORT (B) CONNECTIONS. WELDS IN BOTH CASES ARE TOO SMALL TO DEVELOP 100% JOINT EFFICIENCY.

PHOTOS.— VOL. 4, PAGES

(A) 517, 518

(B) 511, 512

PHOTO. PAGE 510

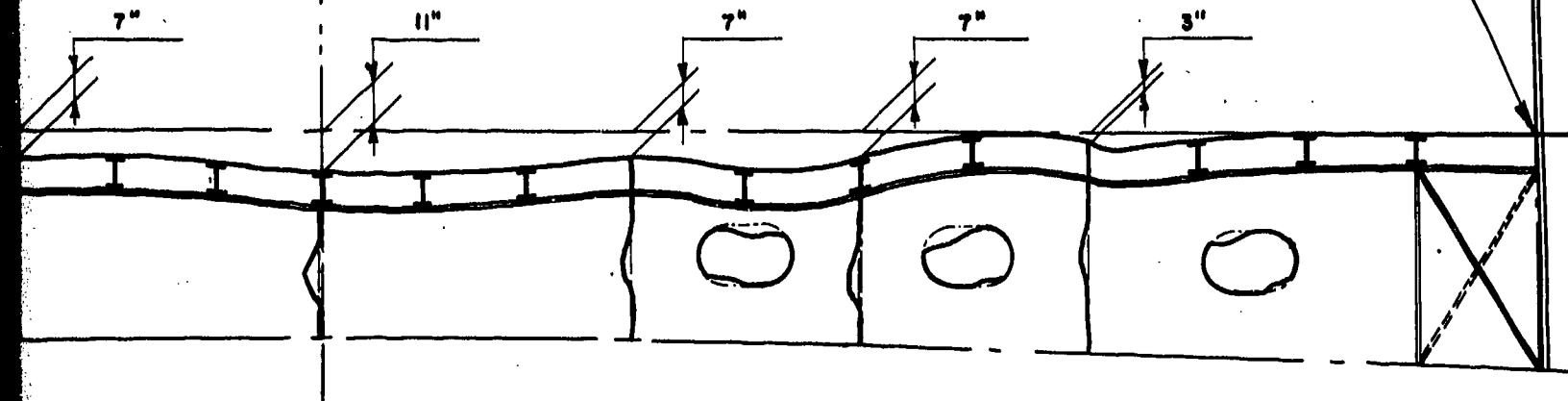

TRANSVERSE SECTION AT FR. 104
LOOKING AFT

2

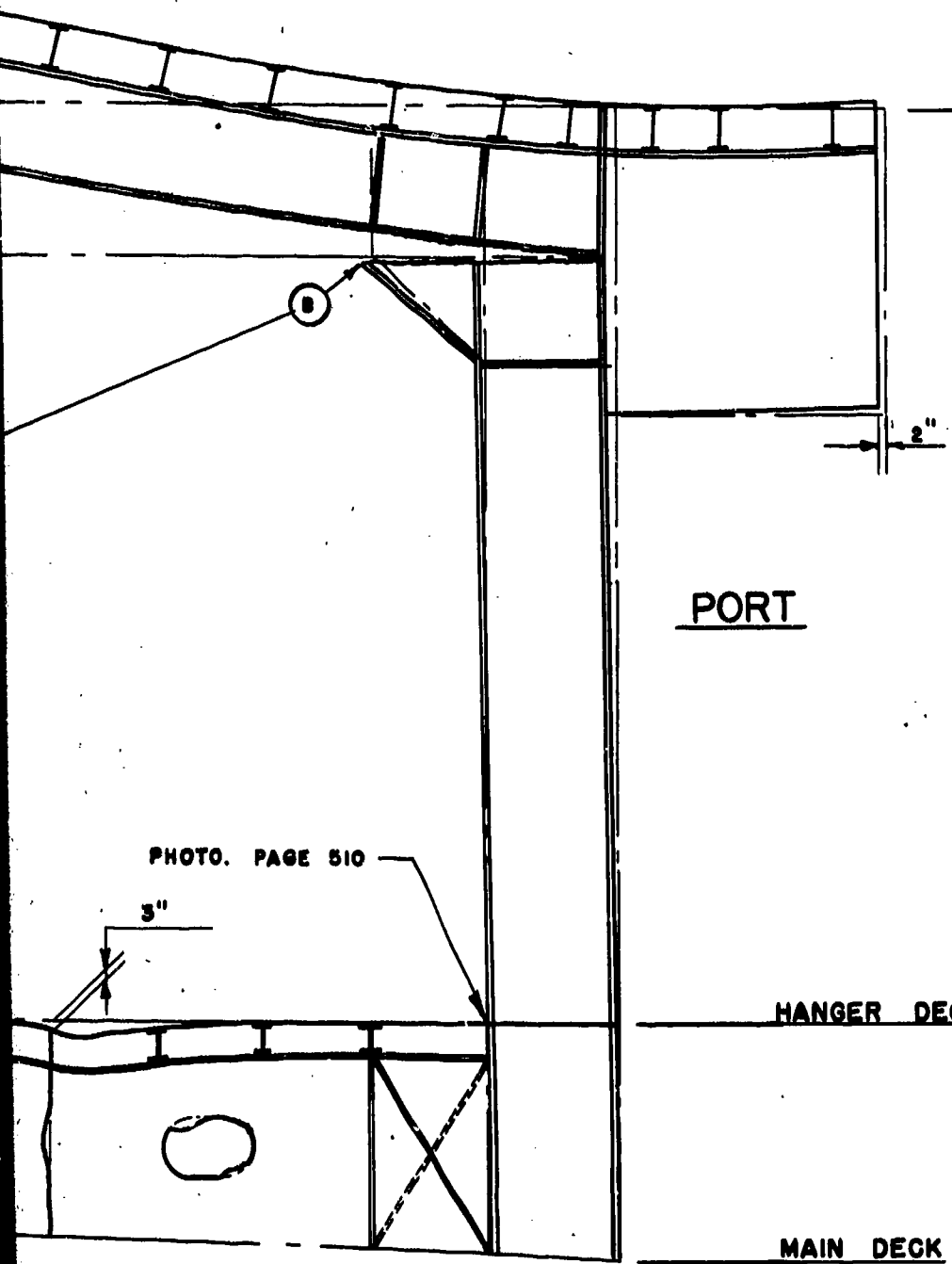

FLIGHT DECK

_____ BEFORE TEST
 _____ AFTER TEST

PORT

PHOTO. PAGE 510

3"

HANGER DECK

SECRET

PAGE 223 OF 280

NAVY DEPT.

BUREAU OF

FLIGHT & HANGER DK. DEFLE

TRANSVERSE SECTION, FRA

MAIN DECK

TEST A

U.S.S. INDEPENDENCE

PLATE NO. 21

3

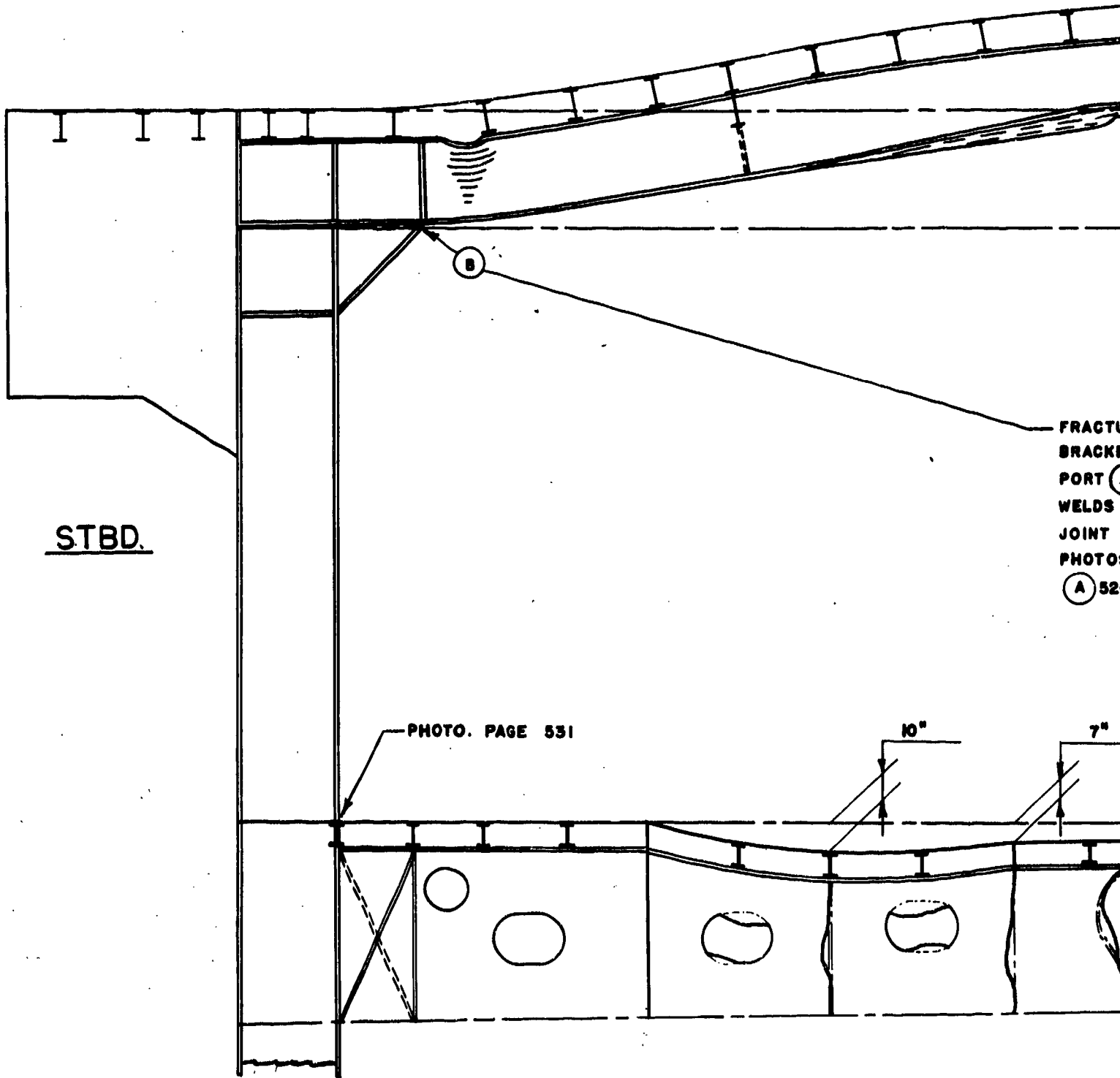

STBD.

PHOTO. PAGE 531

FRACTURE
BRACKET
PORT
WELDS
JOINT
PHOTO
(A) 52

10"

7"

TRANSVERSE

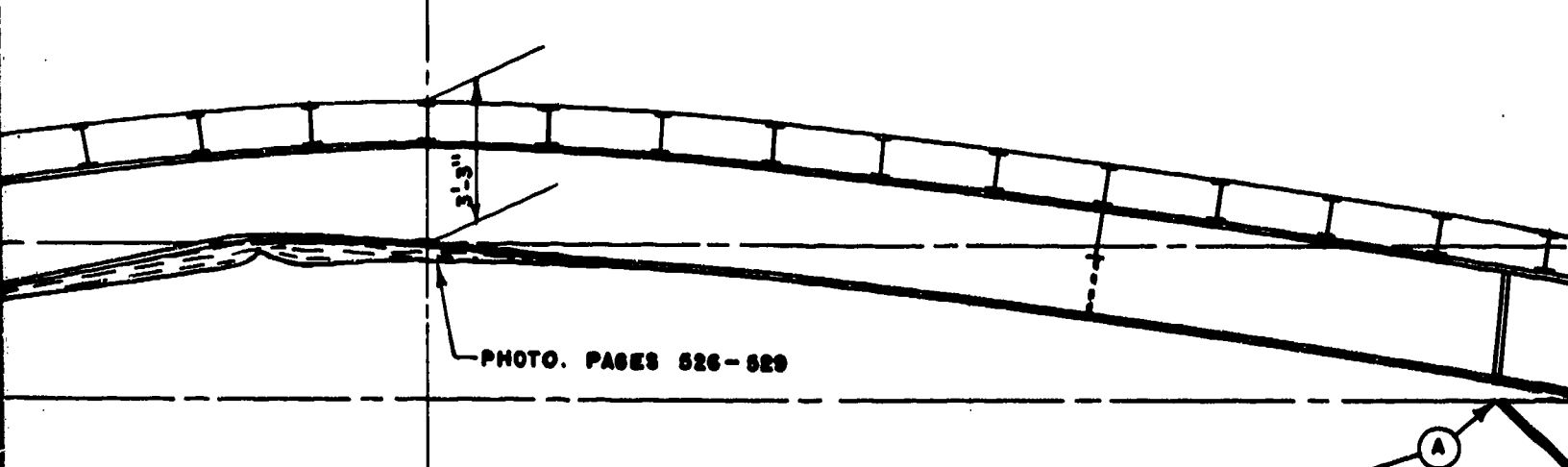

PHOTO. PAGES 526-529

FRACTURE ORIGINATED IN WELDS JOINING
 BRACKET FLANGE AND GIRDER IN BOTH
 PORT (A) AND STARBOARD (B) CONNECTIONS.
 WELDS TOO SMALL TO DEVELOP 100 %
 JOINT EFFICIENCY.
 PHOTOS.- VOL. 4, PAGES
 (A) 520, 524, 525 (B) 523, 530

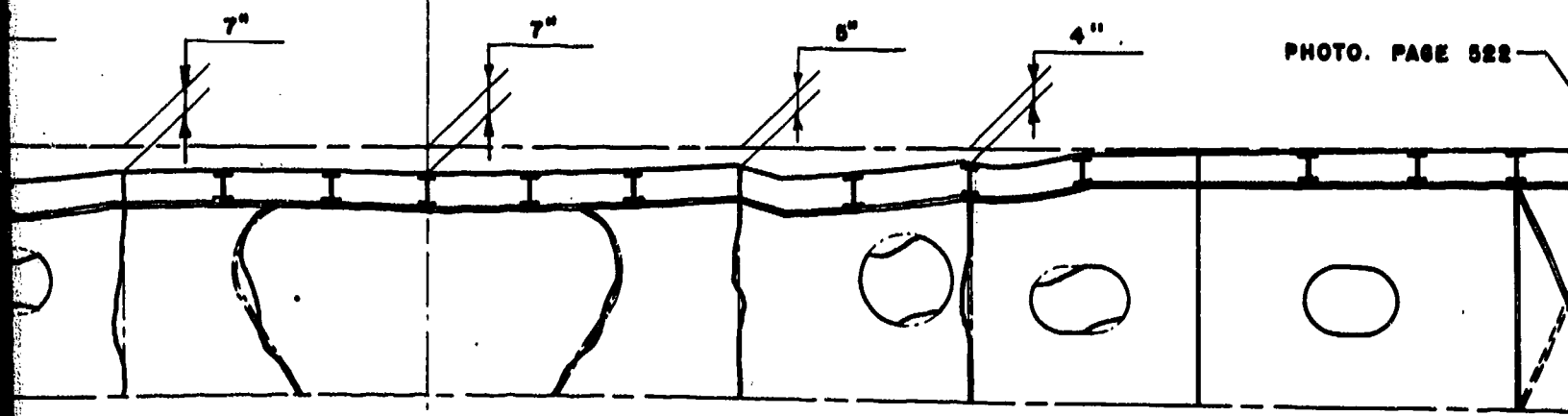
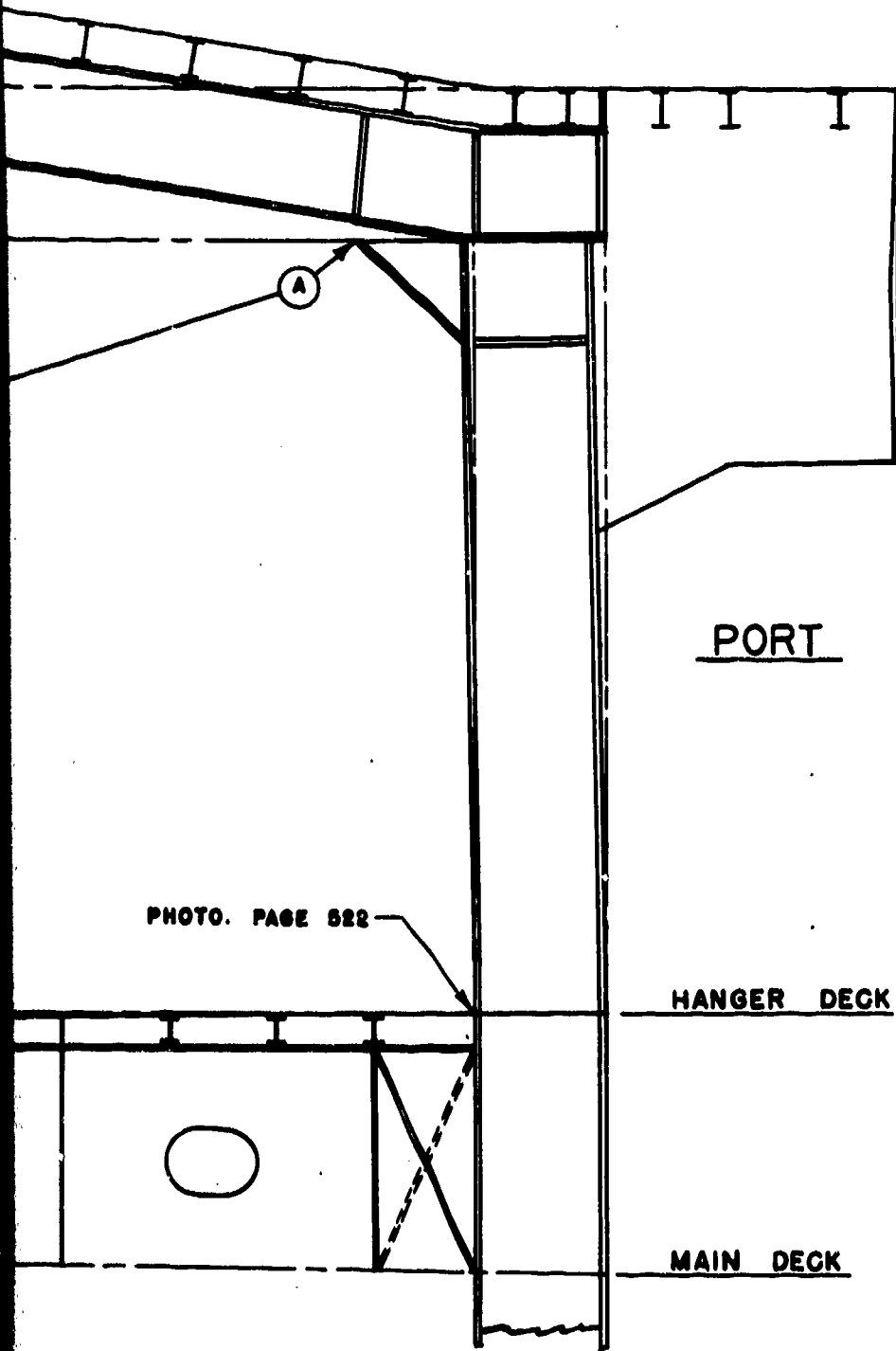

PHOTO. PAGE 522

TRANSVERSE SECTION AT FR. 107
 LOOKING AFT

2



FLIGHT DECK

BEFORE TEST

AFTER TEST

PORT

PHOTO. PAGE 522

HANGER DECK

MAIN DECK

SECRET

PAGE 224 OF 280

NAVY DEPT.

BUREAU OF

FLIGHT & HANGER DK. DEFLECT

TRANSVERSE SECTION, FRAME

TEST A

U.S.S. INDEPENDENCE

CV

PLATE NO. 22

3

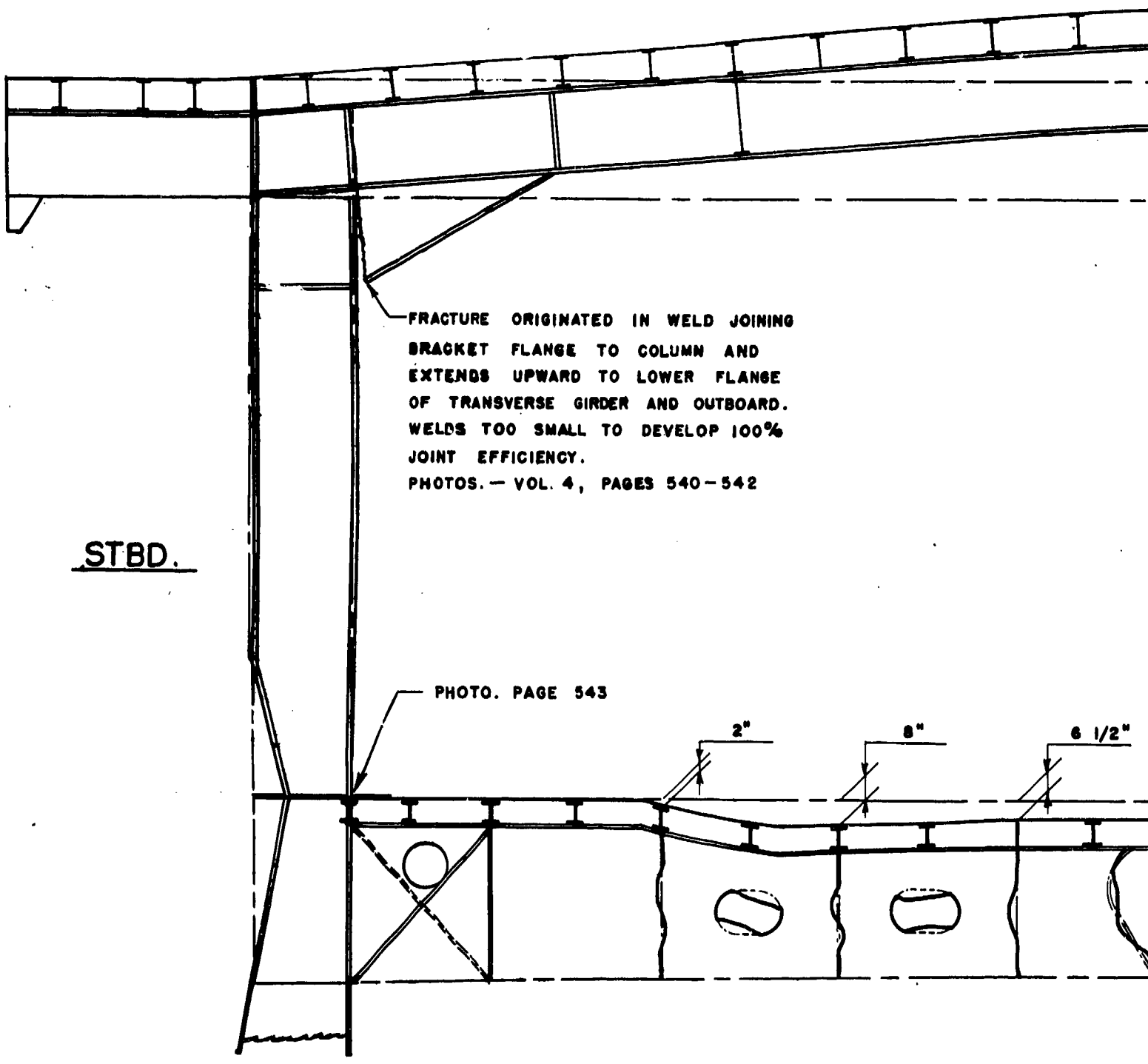

FRACTURE ORIGINATED IN WELD JOINING
BRACKET FLANGE TO COLUMN AND
EXTENDS UPWARD TO LOWER FLANGE
OF TRANSVERSE GIRDER AND OUTBOARD.
WELDS TOO SMALL TO DEVELOP 100%
JOINT EFFICIENCY.
PHOTOS. — VOL. 4, PAGES 540-542

STBD.

PHOTO. PAGE 543

2"

8"

6 1/2"

TRANSVERS
LO

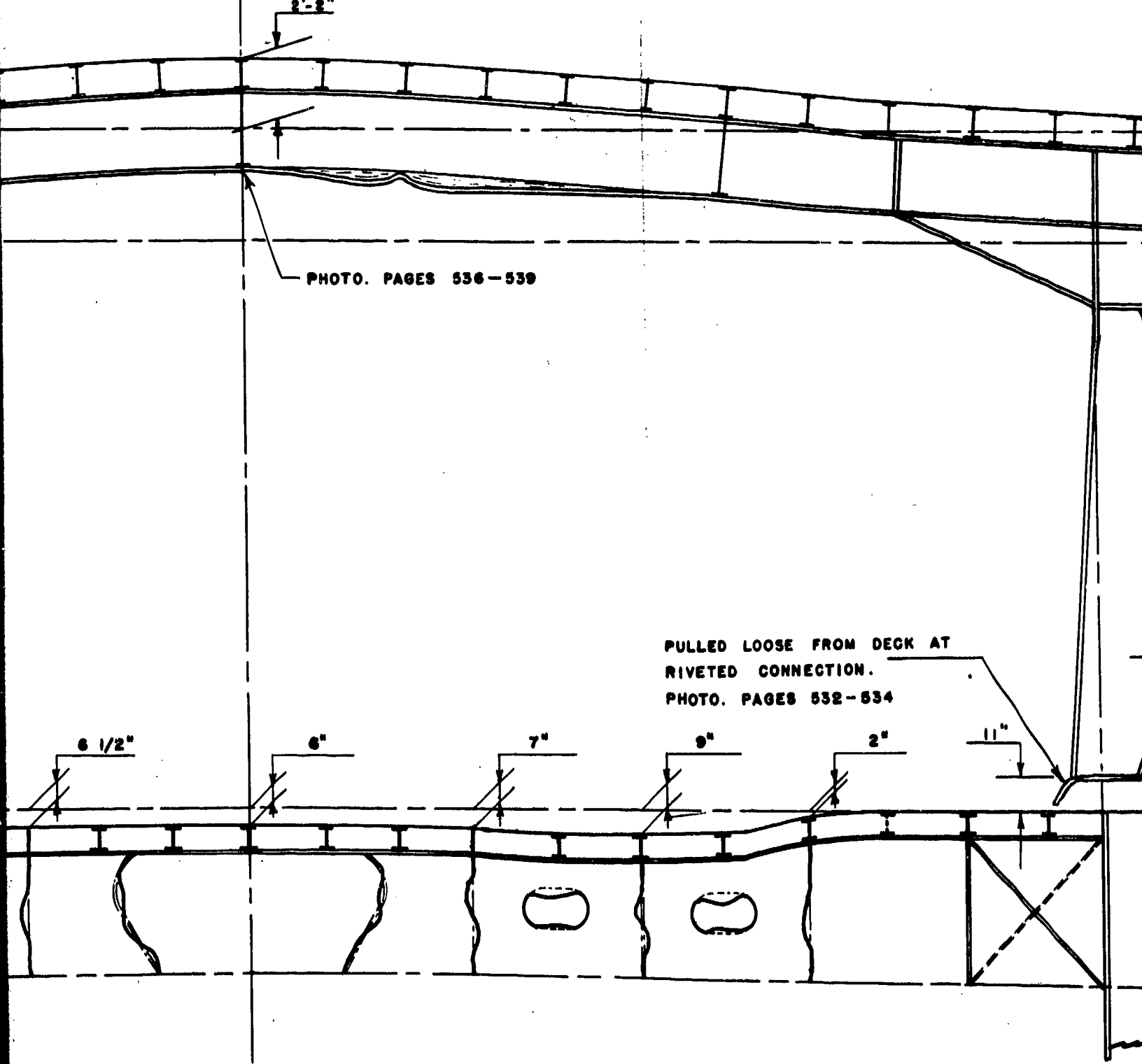

PHOTO. PAGES 536-539

PULLED LOOSE FROM DECK AT
RIVETED CONNECTION.
PHOTO. PAGES 532-534

6 1/2"

6"

7"

9"

2"

11"

TRANSVERSE SECTION AT FR. 110
LOOKING AFT

2

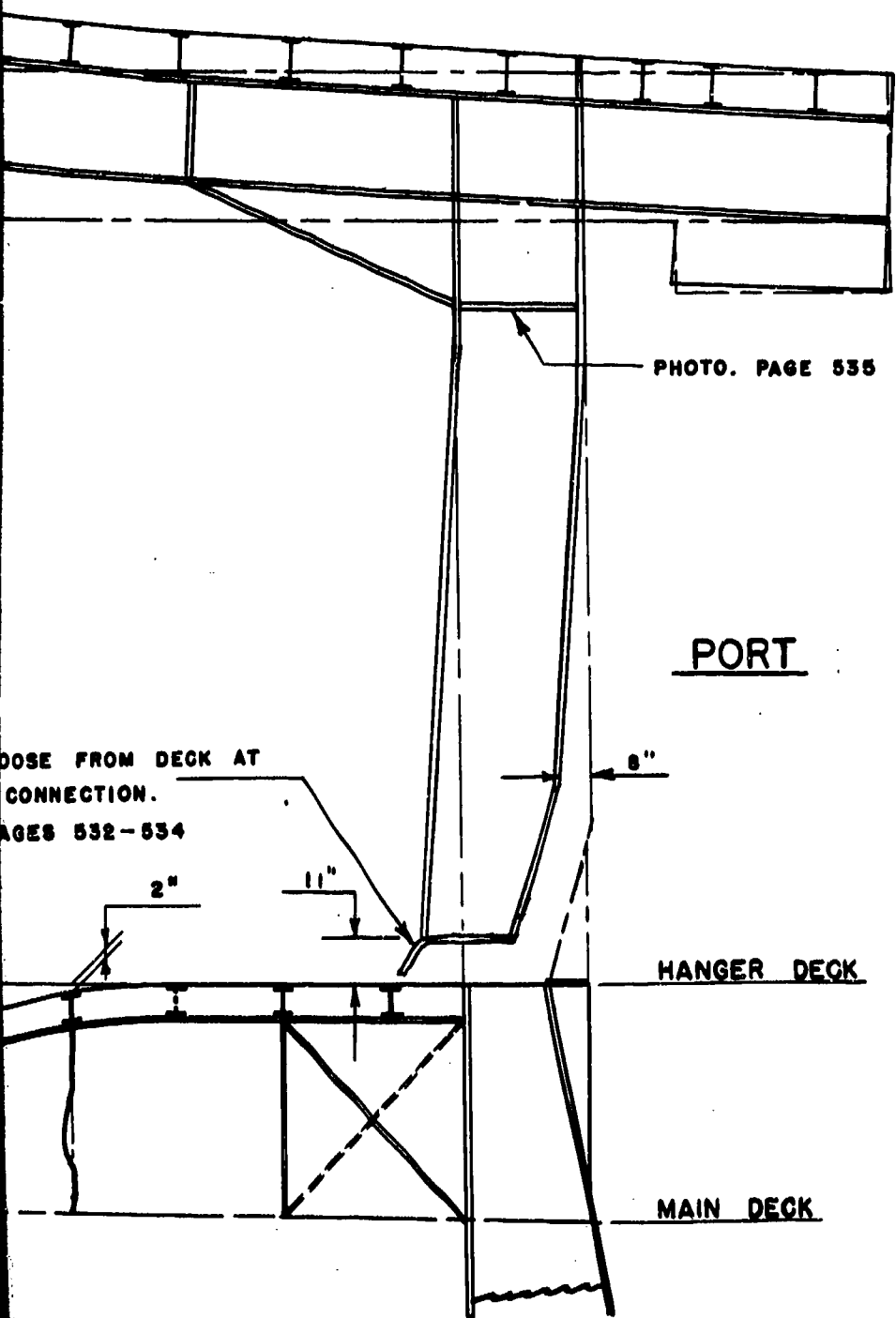

FLIGHT DECK

PHOTO. PAGE 535

BEFORE TEST

AFTER TEST

PORT

DOSE FROM DECK AT CONNECTION.
PAGES 532-534

HANGER DECK

MAIN DECK

SECRET PAGE 225 OF 280

NAVY DEPT. BUREAU OF

FLIGHT & HANGER DK. DEFLECTION
TRANSVERSE SECTION FRAME

TEST A

U.S.S. INDEPENDENCE CV

PLATE NO. 23

3

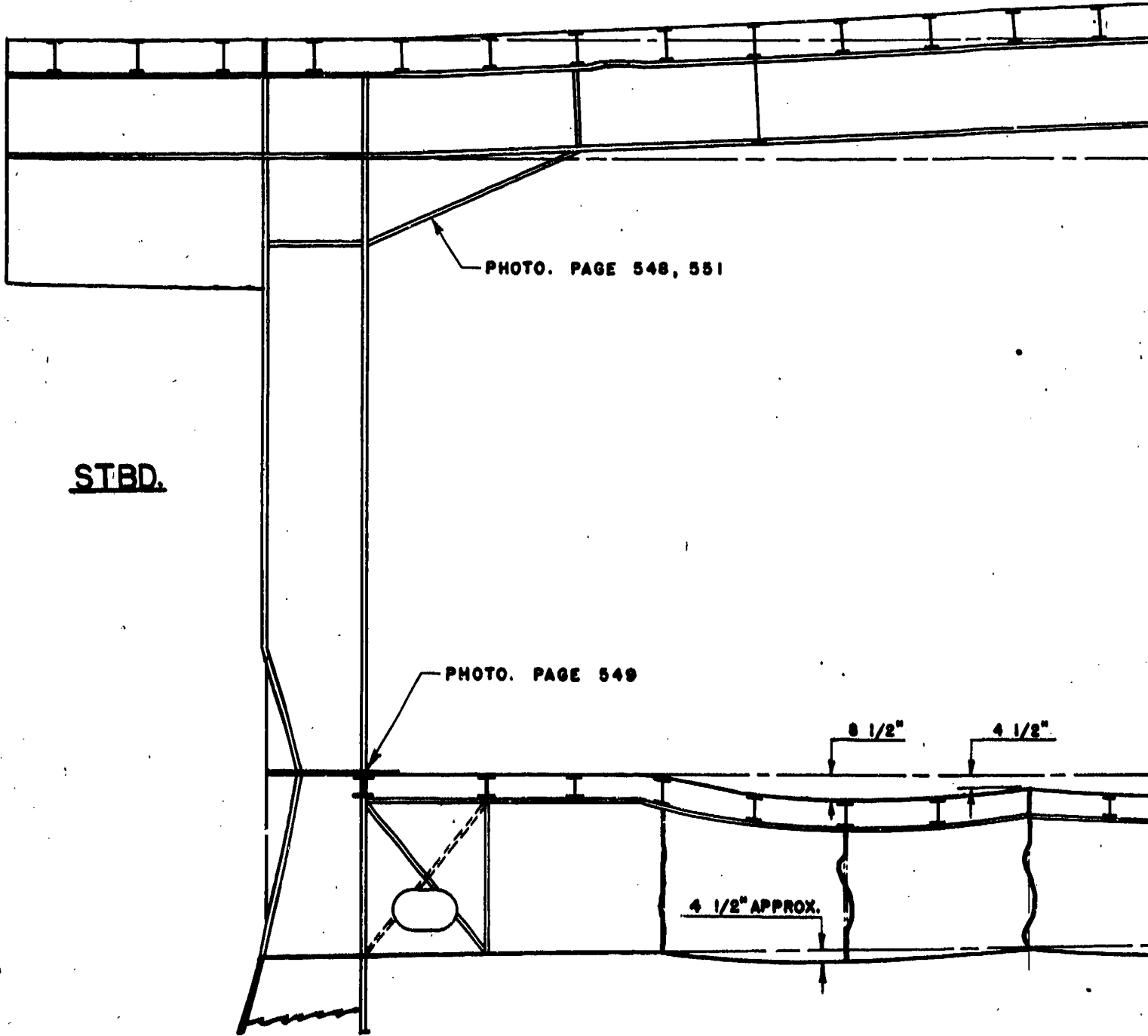

STBD.

PHOTO. PAGE 548, 551

PHOTO. PAGE 549

$8\ 1/2"$

$4\ 1/2"$

$4\ 1/2"$ APPROX.

TRANSVER

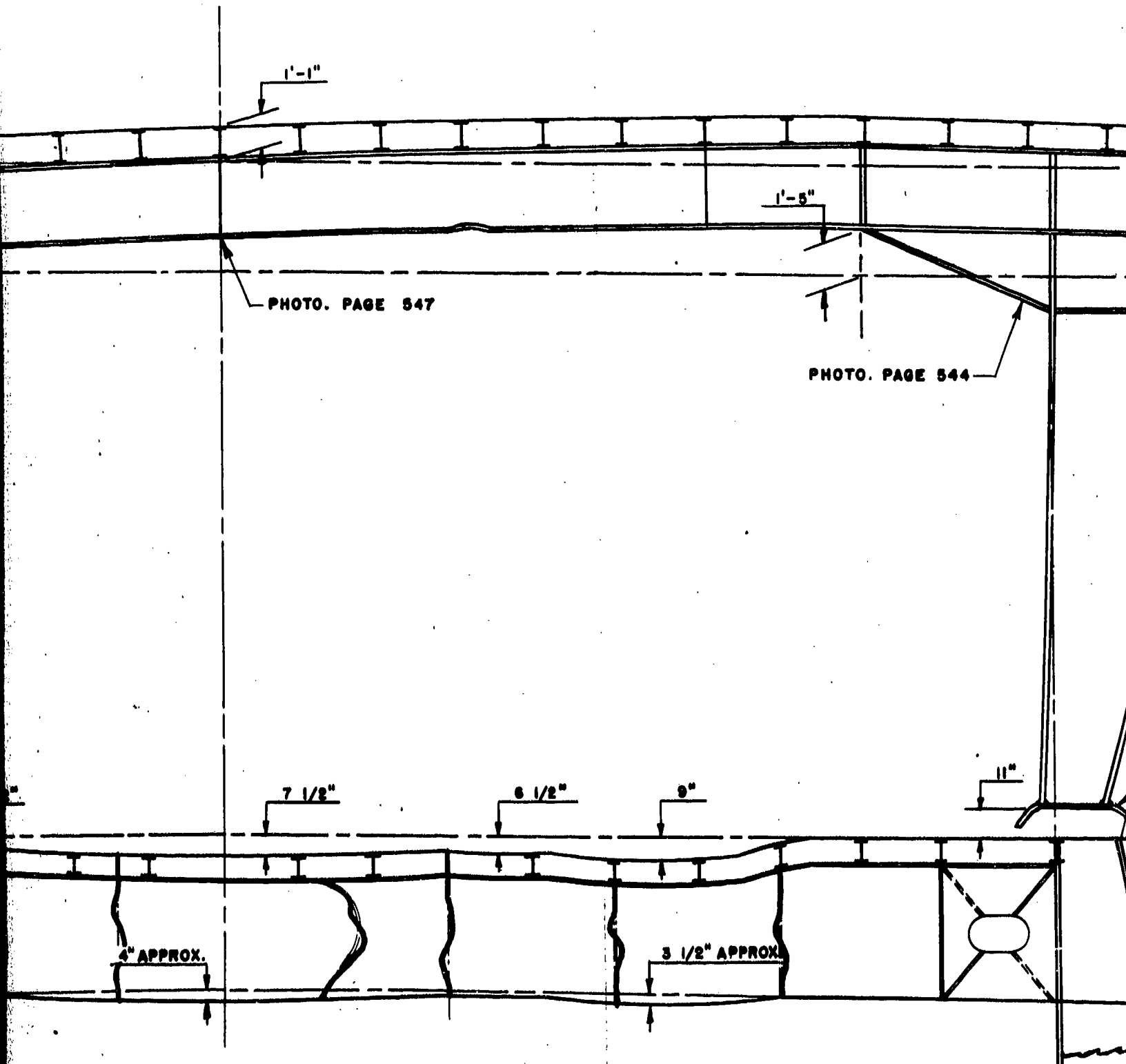

TRANSVERSE SECTION AT FR. 113
LOOKING AFT

2

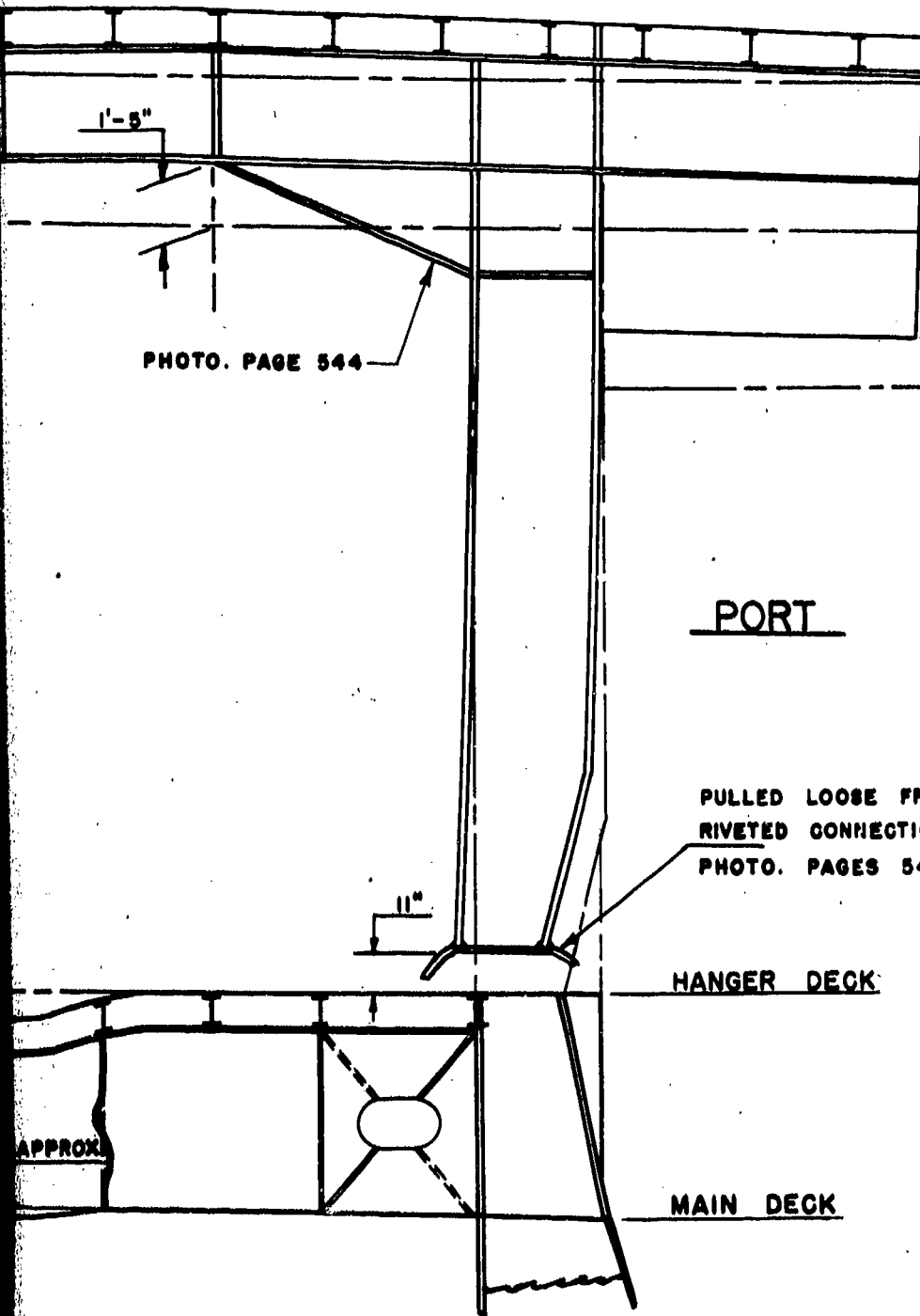

FLIGHT DECK

1'-5"

PHOTO. PAGE 544

1'-2"

BEFORE TEST
AFTER TEST

PORT

PULLED LOOSE FROM DECK AT
RIVETED CONNECTION.
PHOTO. PAGES 545, 546

11"

HANGER DECK

SECRET PAGE 226 OF 280

NAVY DEPT. BUREAU OF

FLIGHT & HANGER DK. DEFLE

TRANSVERSE SECTION, FRAM

TEST A

U.S.S. INDEPENDENCE CV

MAIN DECK

APPROX

PLATE NO. 24

3

STBD.

PHOTO. PAGE 555

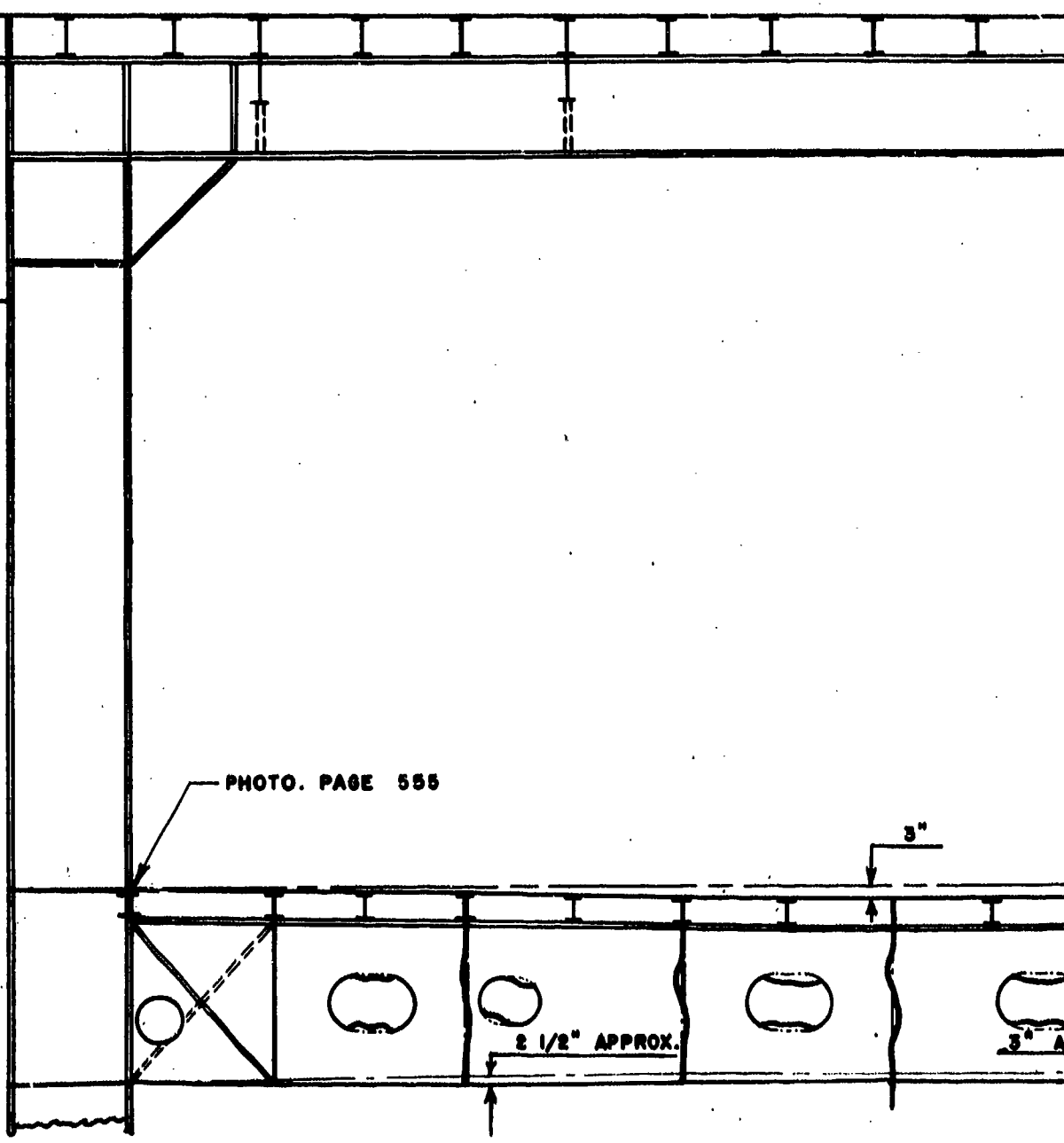

TRANSVERS

PHOTO. PAGES 552, 553

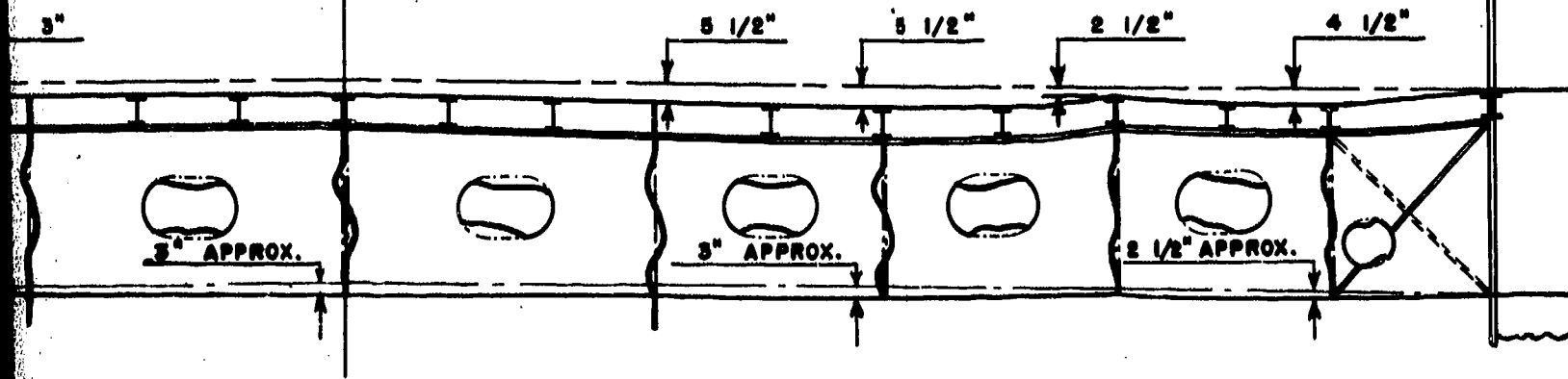

TRANSVERSE SECTION AT FR.115
LOOKING AFT

2

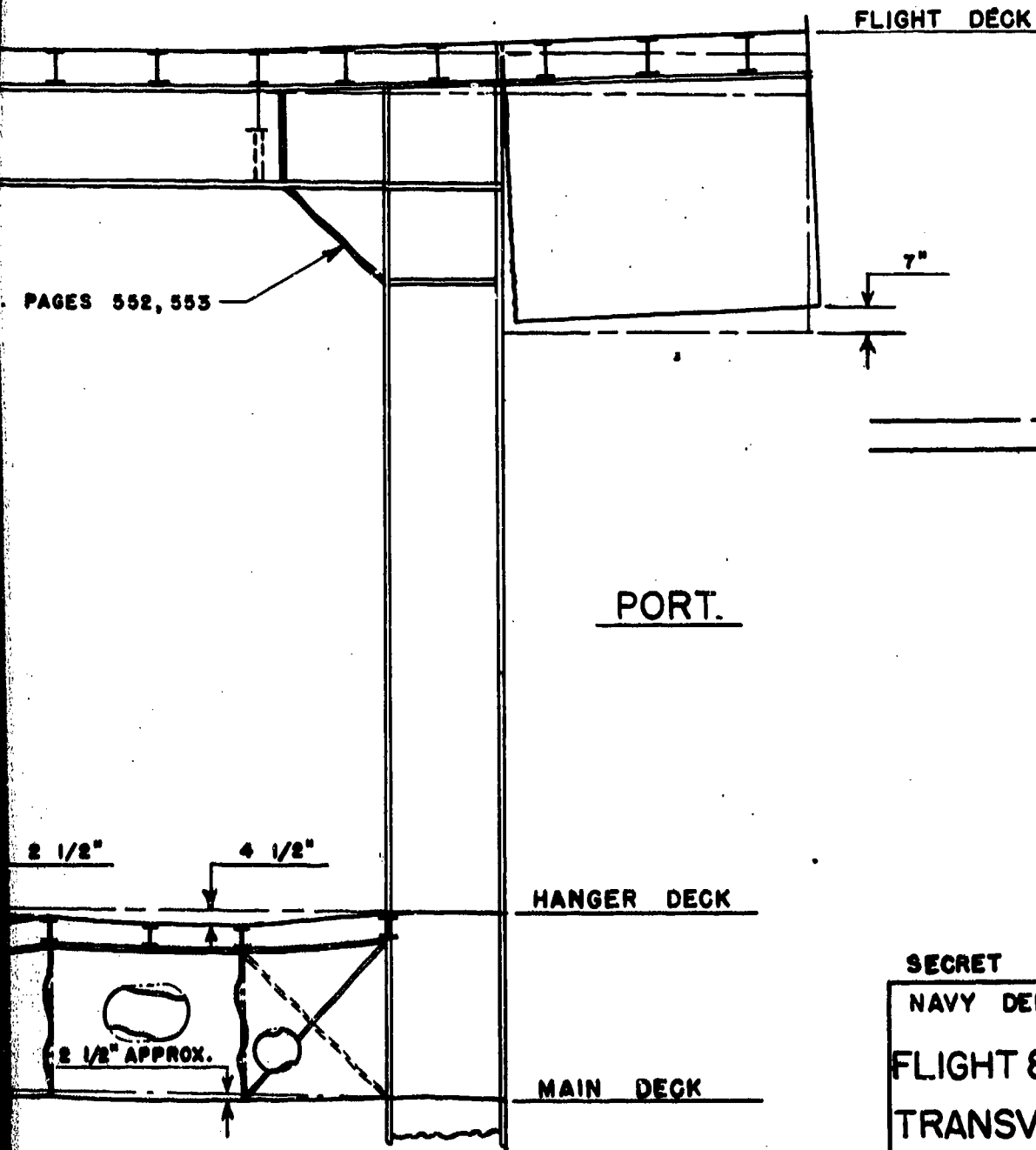

FLIGHT DECK

PAGES 552, 553

7"

BEFORE TEST
AFTER TEST

PORT.

2 1/2"

4 1/2"

HANGER DECK

2 1/2" APPROX.

MAIN DECK

SECRET

PAGE 227 OF 280

NAVY DEPT.

BUREAU OF

FLIGHT & HANGER DK. DEFLE
TRANSVERSE SECTION, FRAM

TEST A

U.S.S. INDEPENDENCE

CV

PLATE NO. 25

3

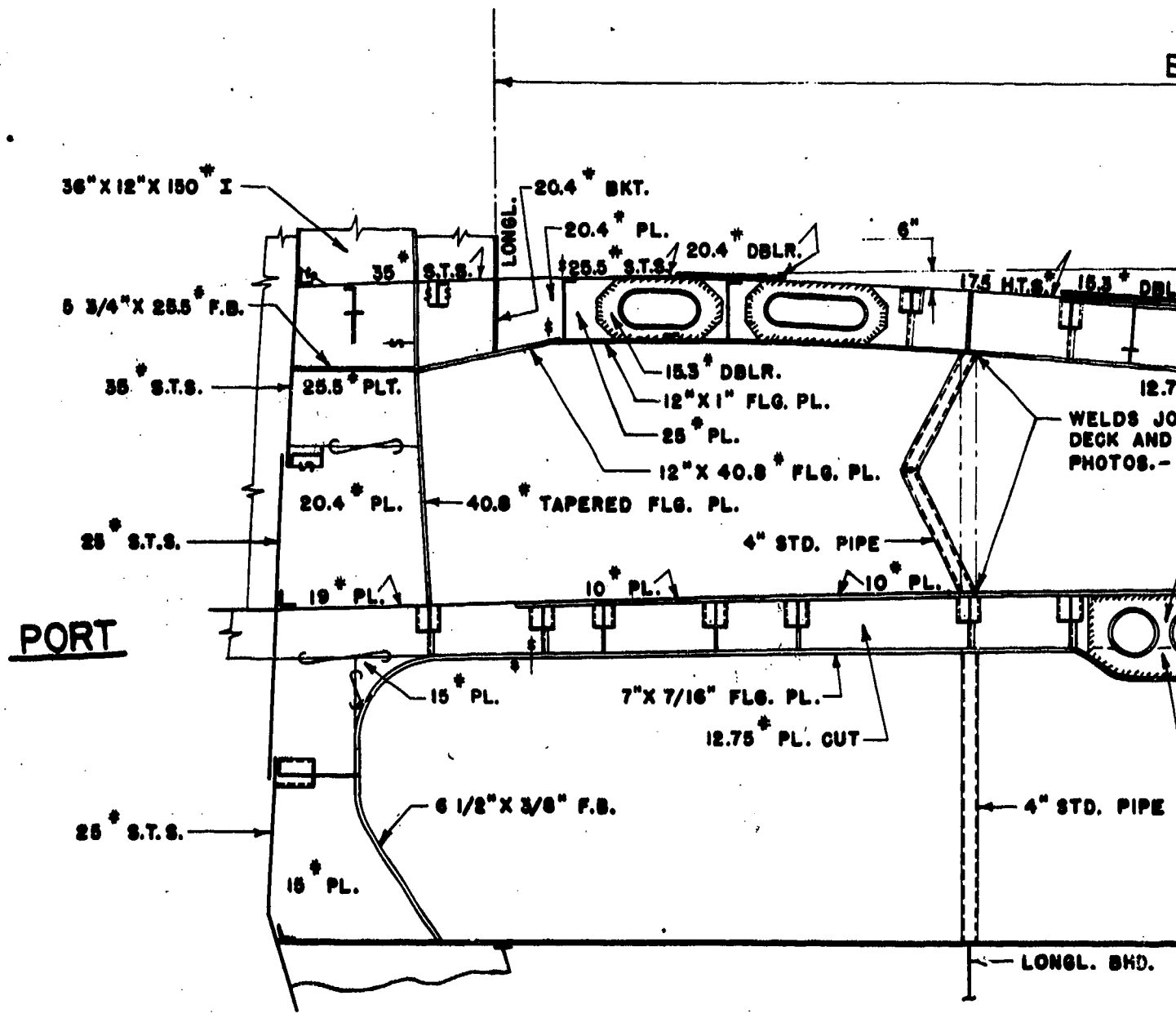

PORT

TRAN

ELEVATOR

PIT

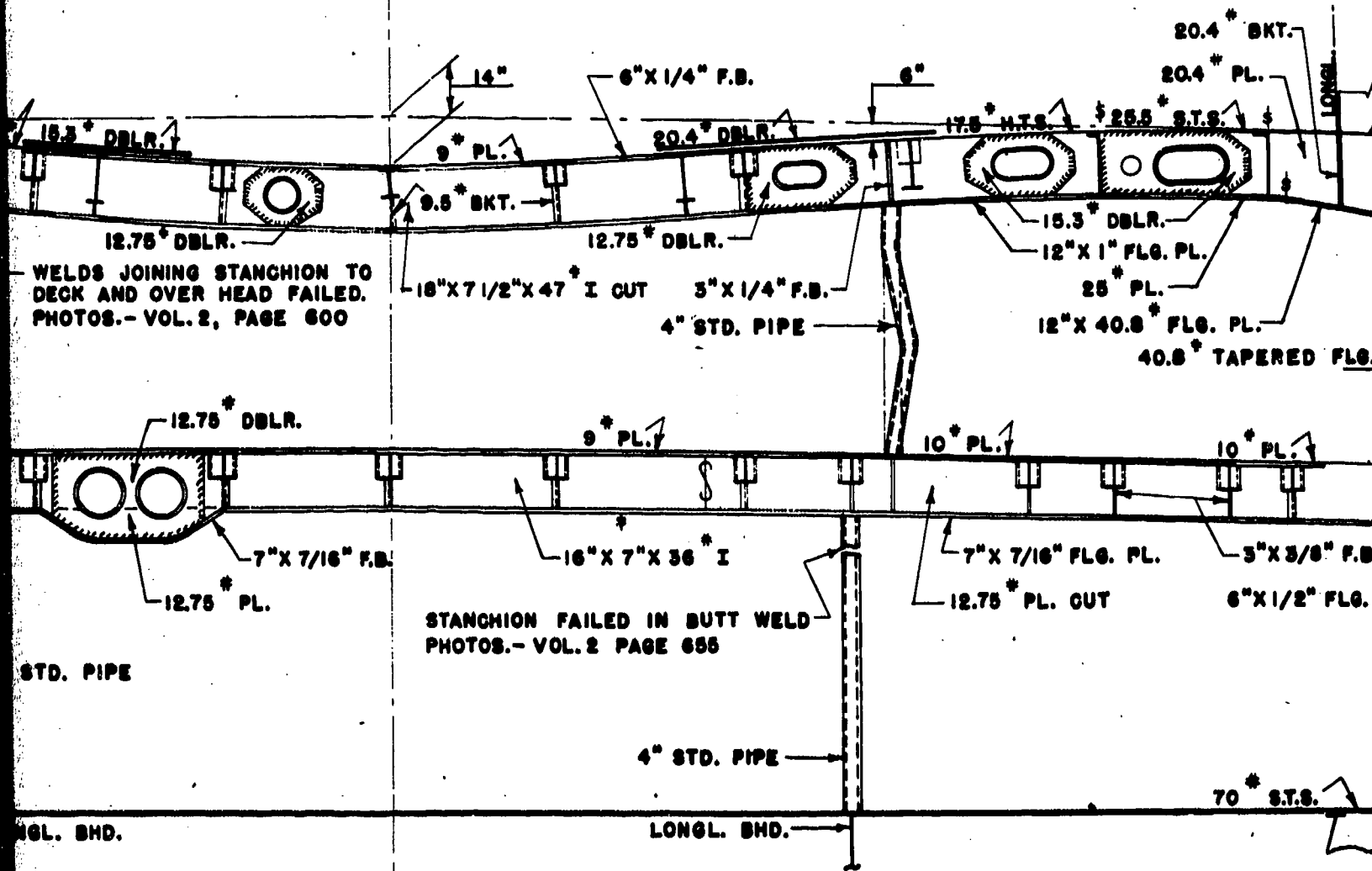

TRANSVERSE SECTION AT FR. 53
LOOKING FORD.

2

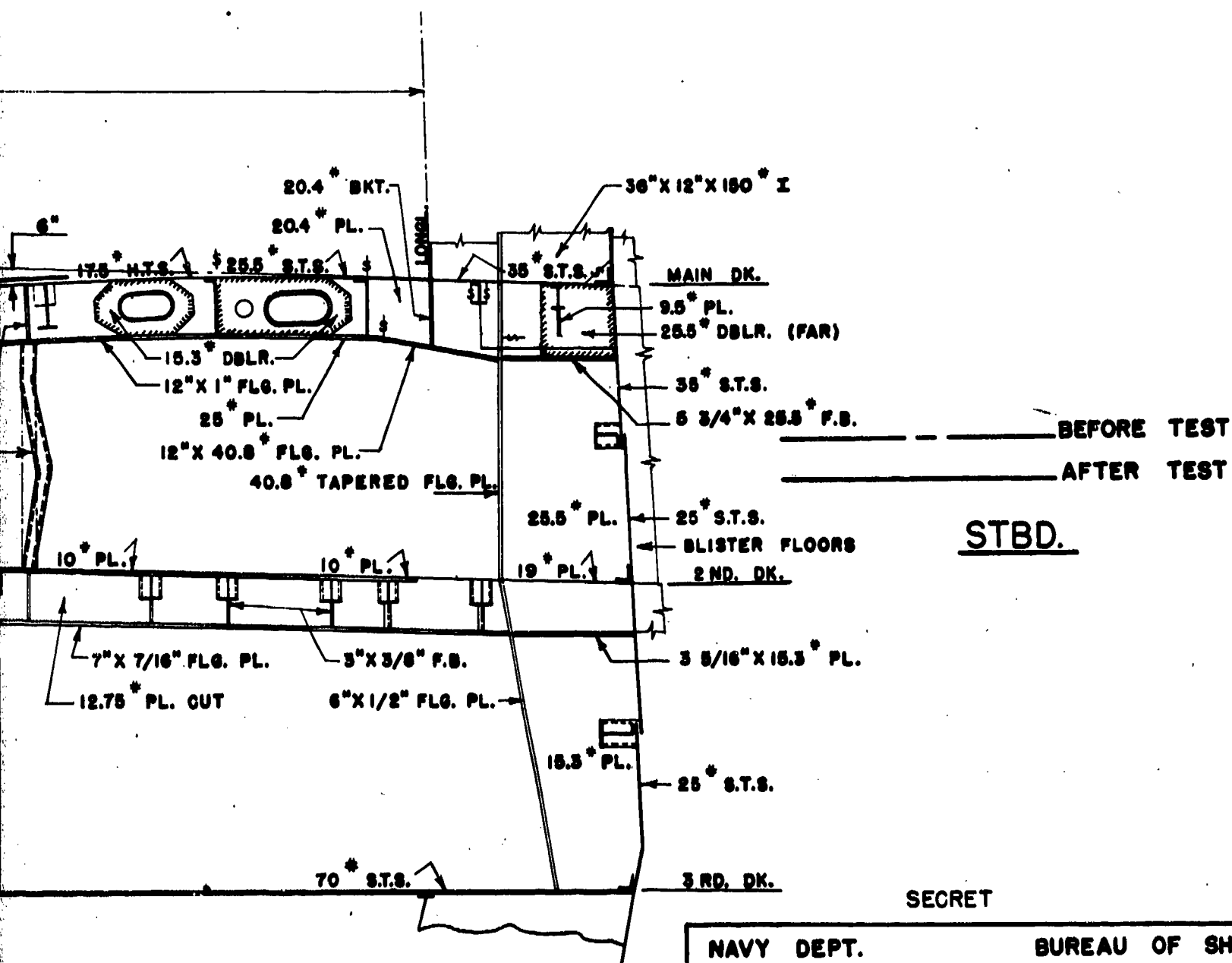

STBD.

SECRET

NAVY DEPT. BUREAU OF SHIPBUILDING
 MAIN & 2ND. DECK DEFLECTION
 TRANSVERSE SECTION, FRAME
 TEST A
 U.S.S. INDEPENDENCE CVL 28

10

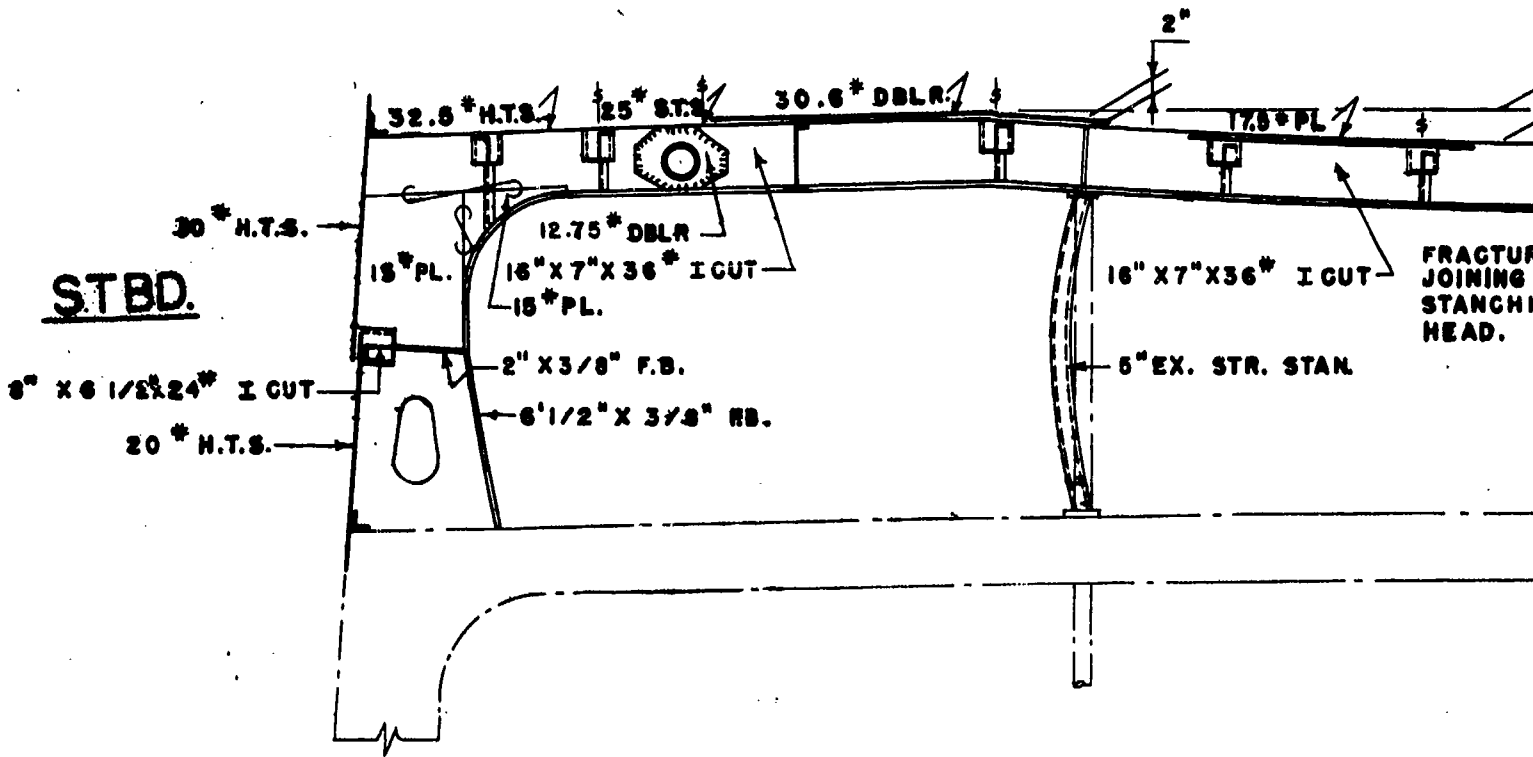

TRAN

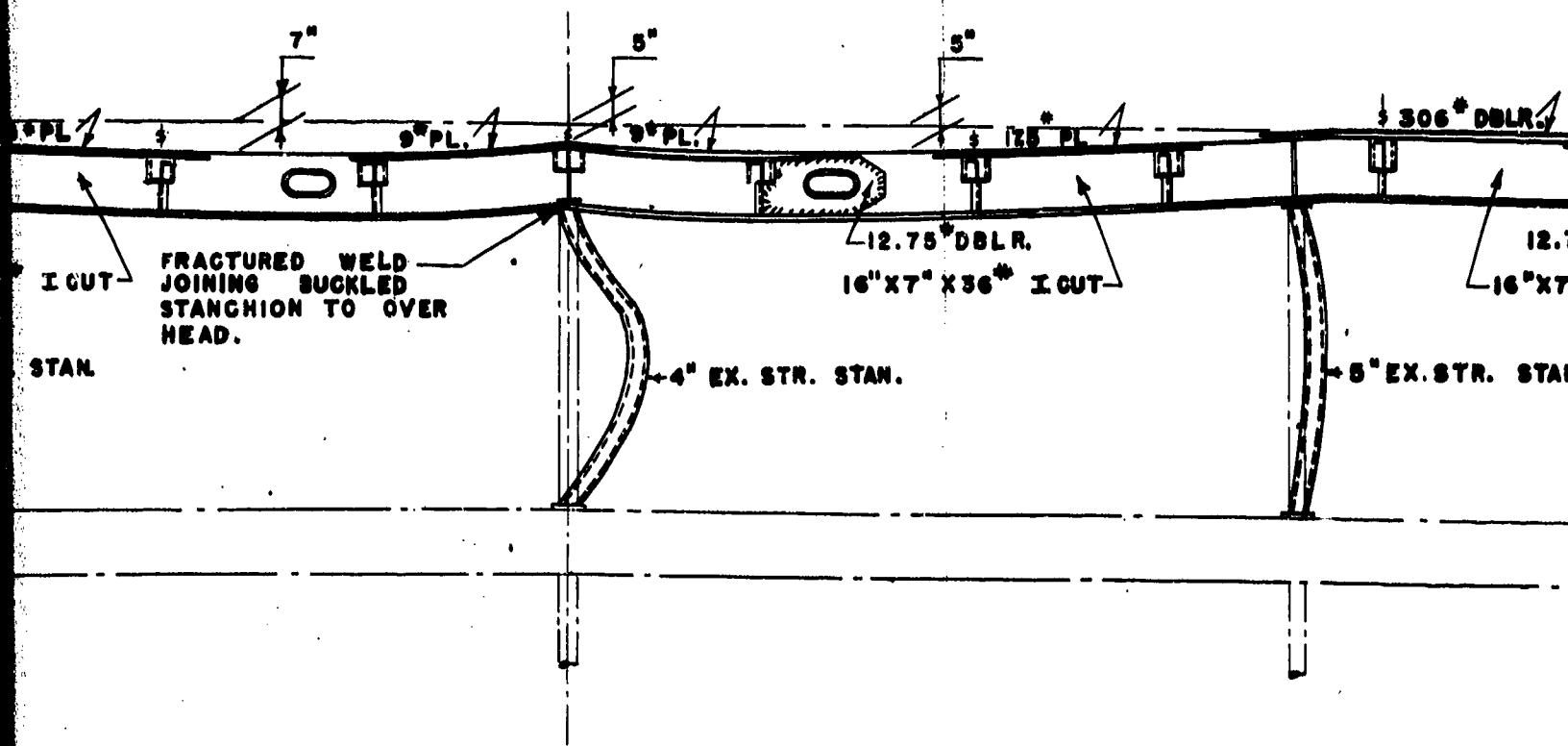

TRANSVERSE SECTION AT FR. 108
 LOOKING AFT.

2

----- BEFORE
----- AFTER T

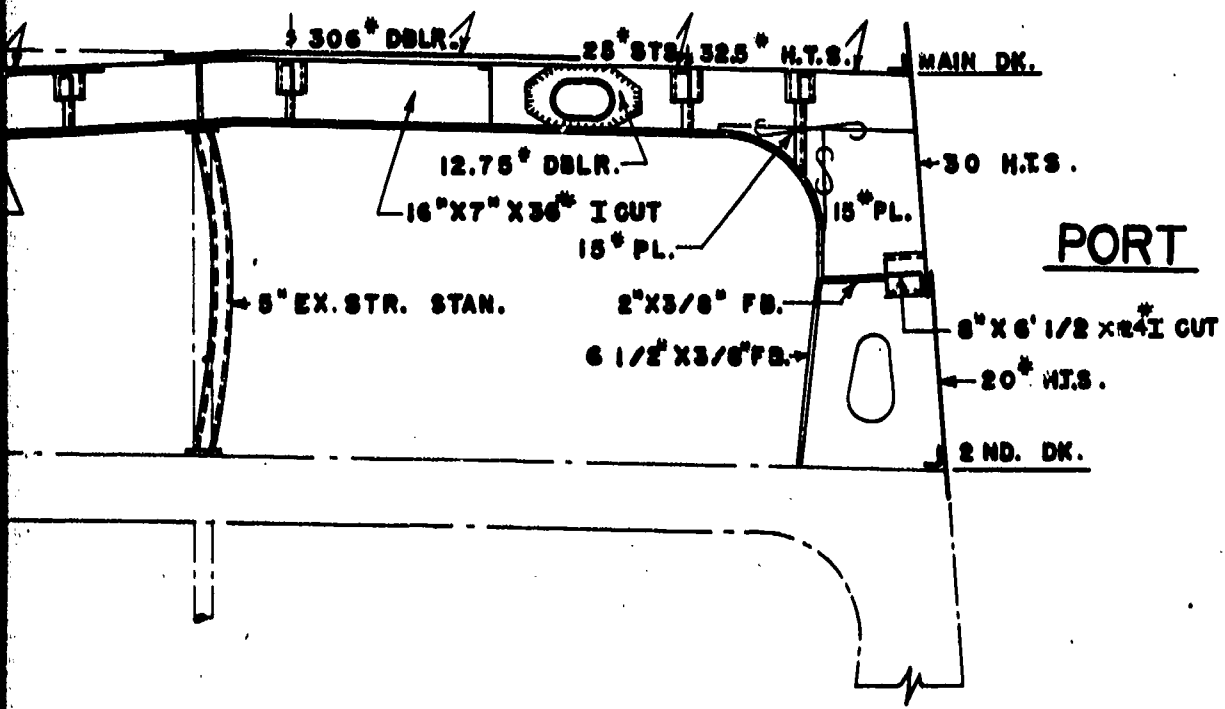

SECRET

NAVY DEPT. BUREAU OF
MAIN & 2ND DECK DEFLECTION
TRANSVERSE SECTION, FRANE

TEST A



EU

STBD.

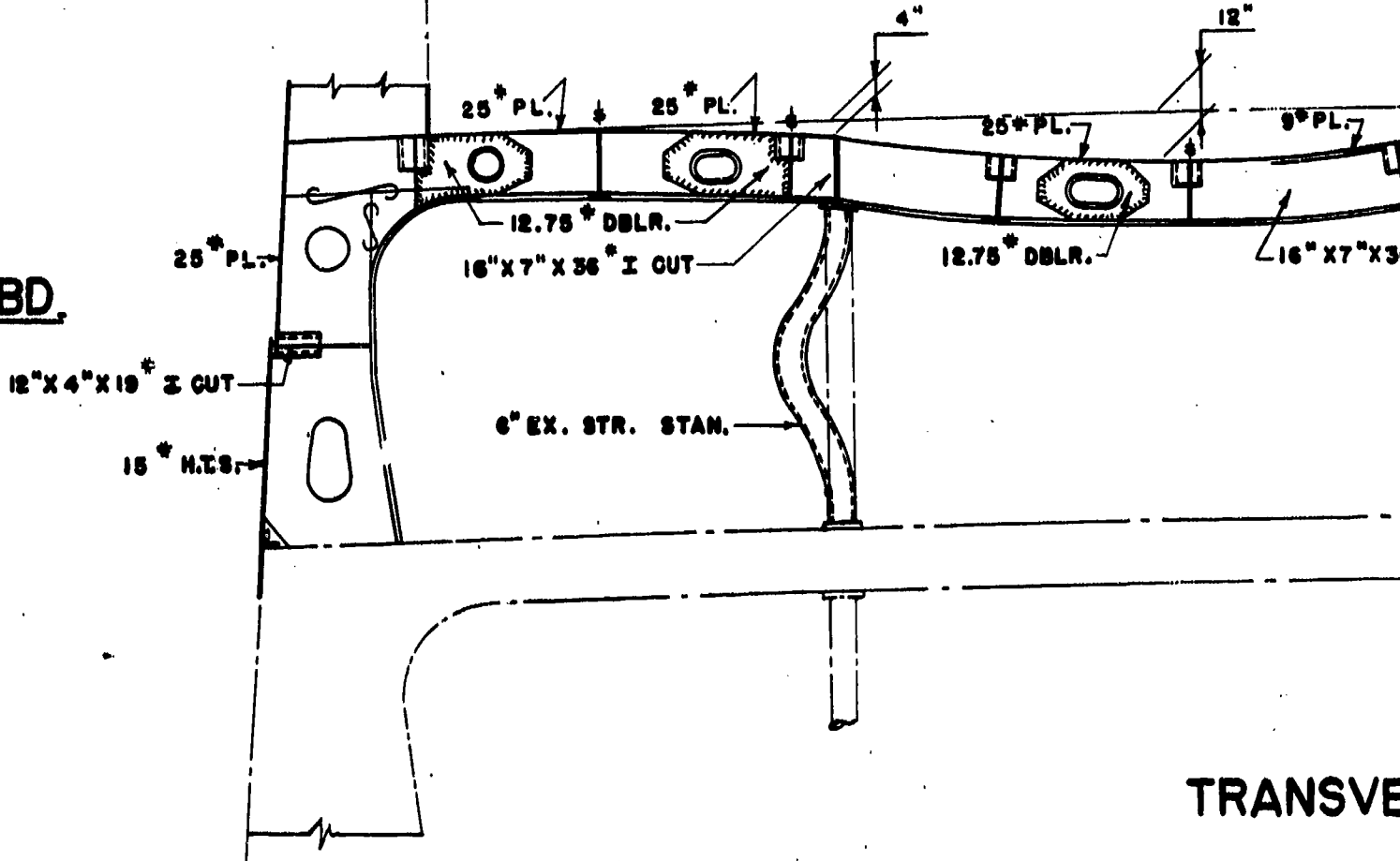

TRANSVE

ELEVATOR PIT

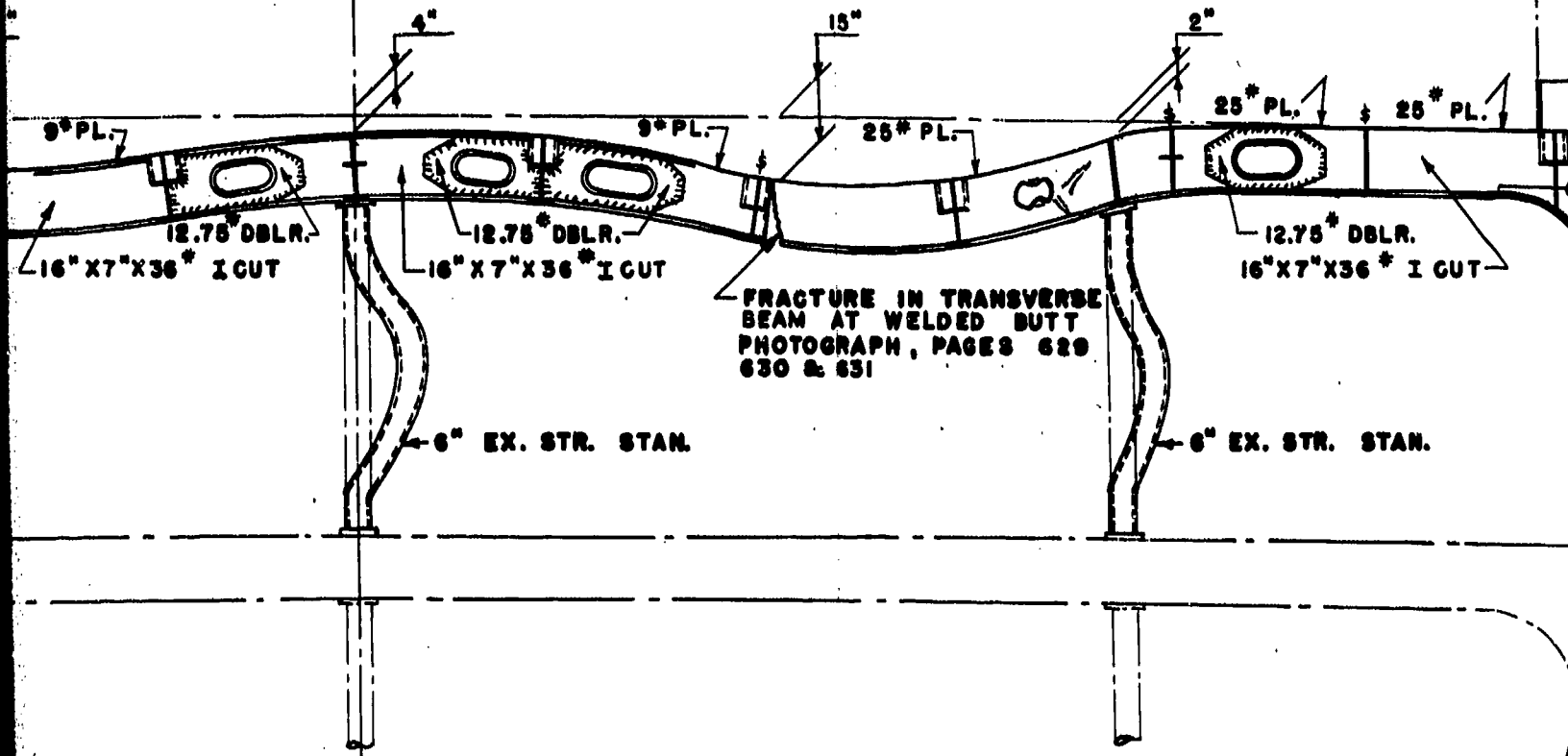

TRANSVERSE SECTION AT FR. 122
LOOKING AFT.

2

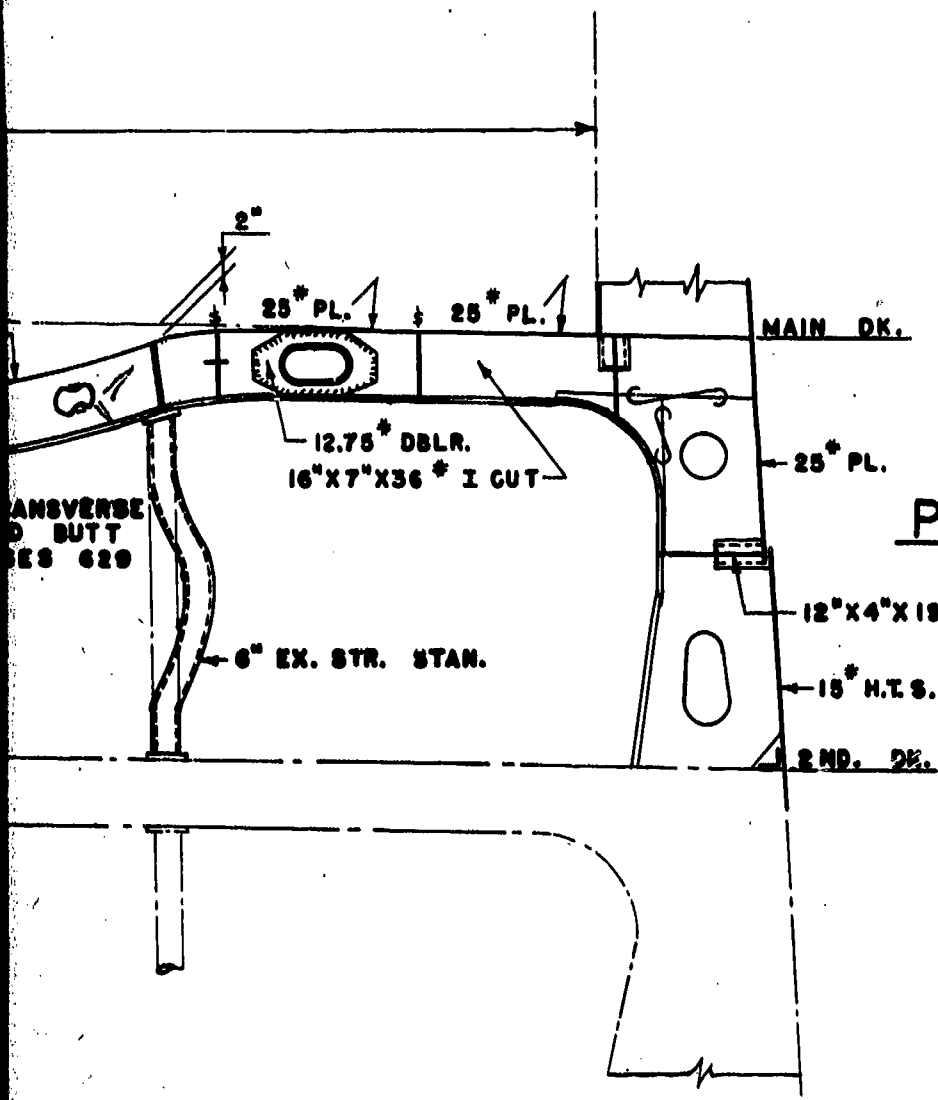

----- BEFORE
 _____ AFTER

SECRET

NAVY DEPT. BUREAU OF SHIP REPAIRS
 MAIN & 2ND. DECK DEFLECTION
 TRANSVERSE SECTION, FRAME
 TEST A
 U.S.S. INDEPENDENCE CV-31



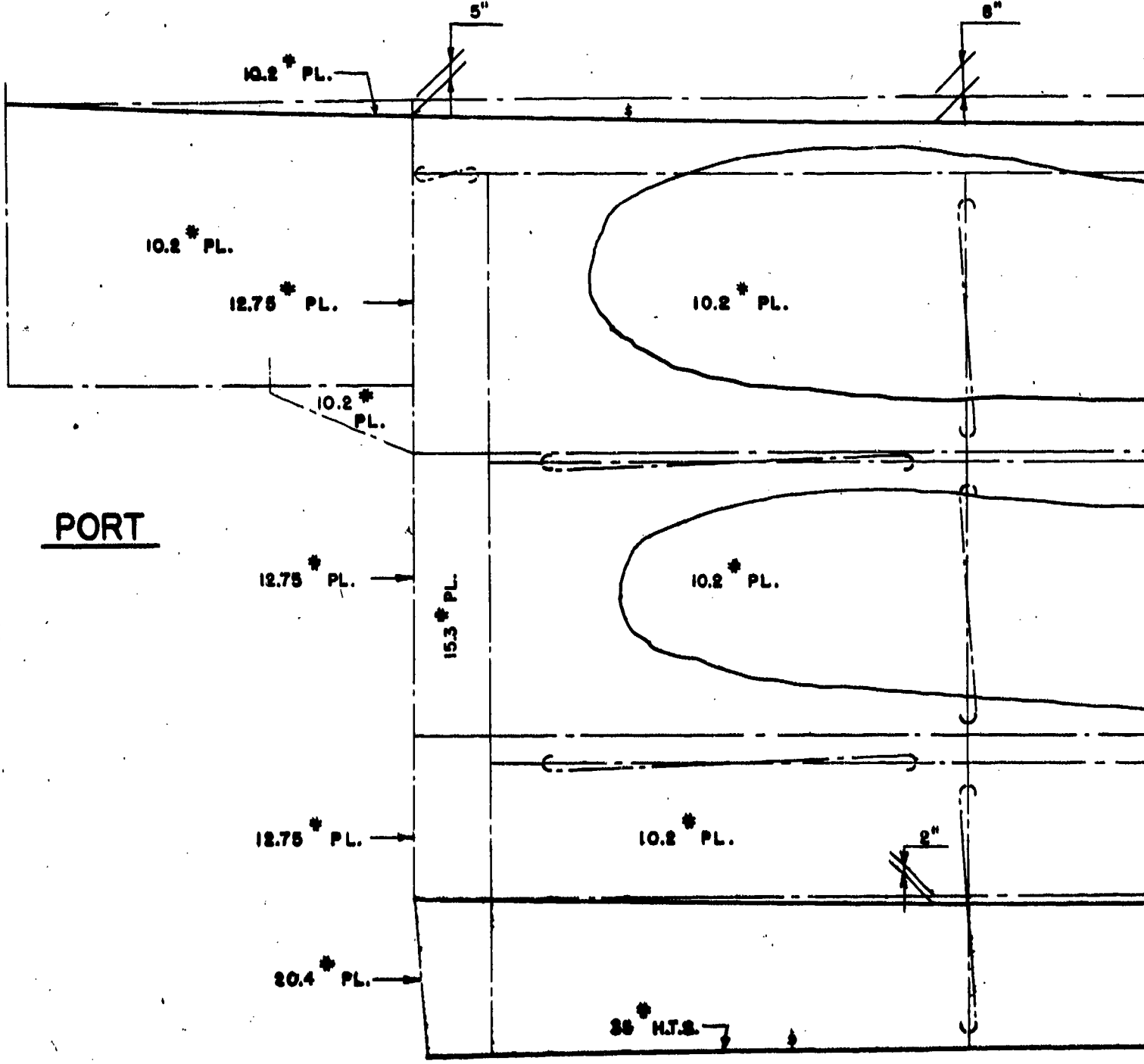

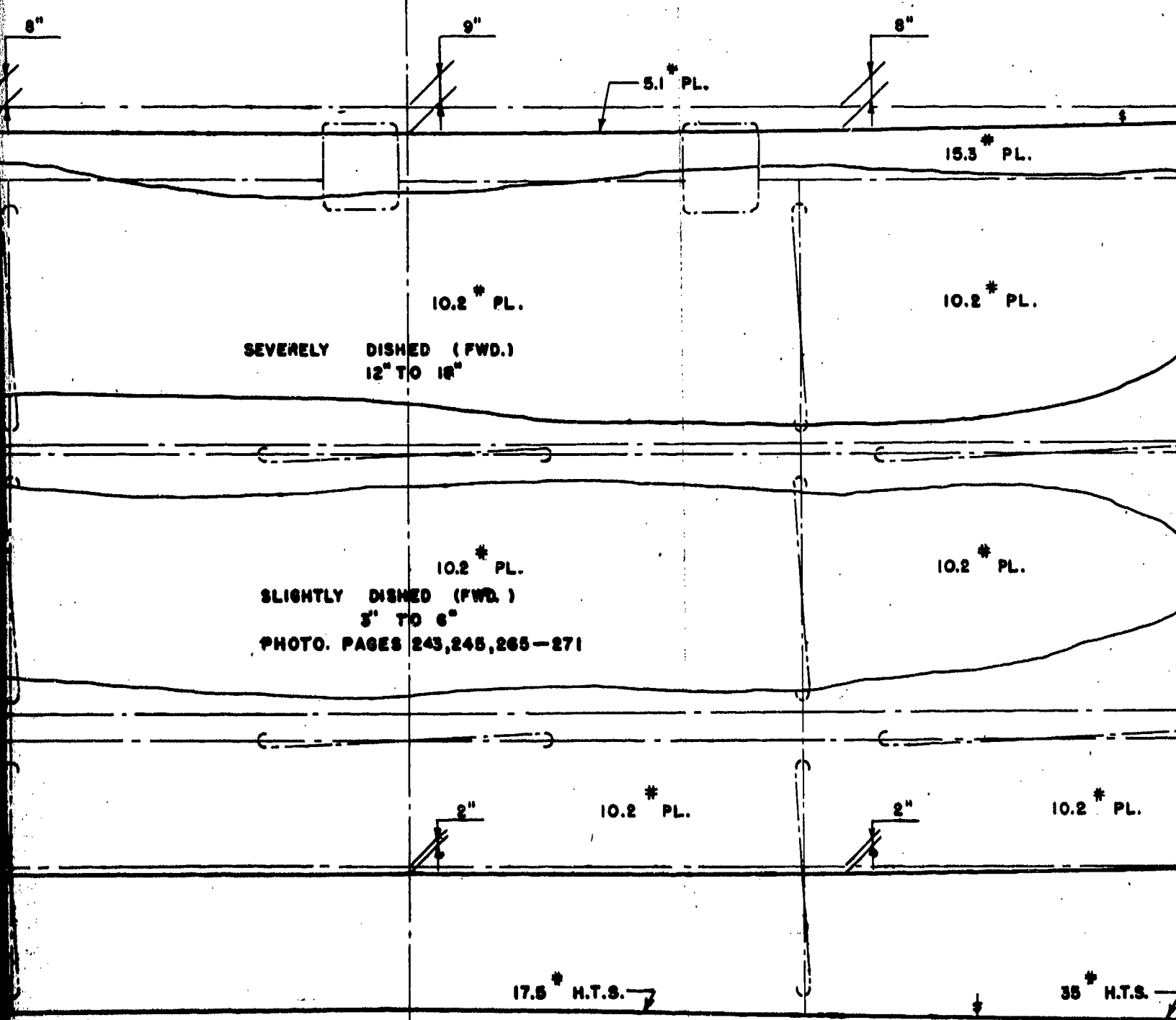

SEVERELY DISHED (FWD.)
12" TO 18"

SLIGHTLY DISHED (FWD.)
3" TO 6"
PHOTO. PAGES 243, 245, 265-271

TRANSV. W.T. BHD. 45
LOOKING FORD.

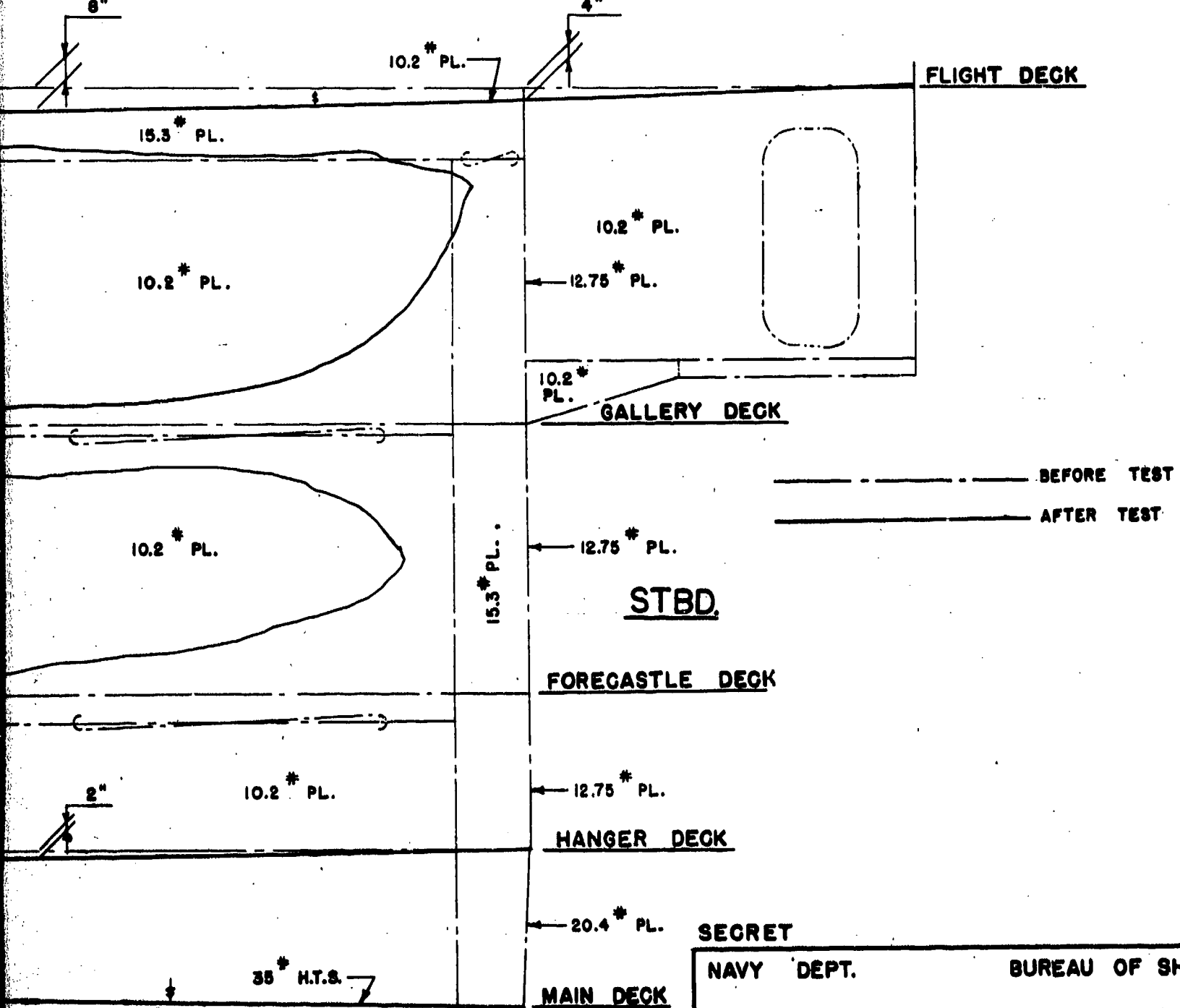

SECRET

NAVY DEPT.

BUREAU OF SHIP

FLIGHT & HANGER DK. DEFLECT

TRANSVERSE BULKHEAD FR

TEST A

U.S.S. INDEPENDENCE

CV

PHOTO. PAGES
588, 592

TEAR

6"

WRINKLE
SEE NOTE

10 # PL.

7 # PL.

7.65 # PL.

12 # PL.

PORT

10 # PL.

12 # PL.

10 # PL.

7 # PL.

7.65 # PL.

12 # PL.

TRANSV. C.T.
LOC

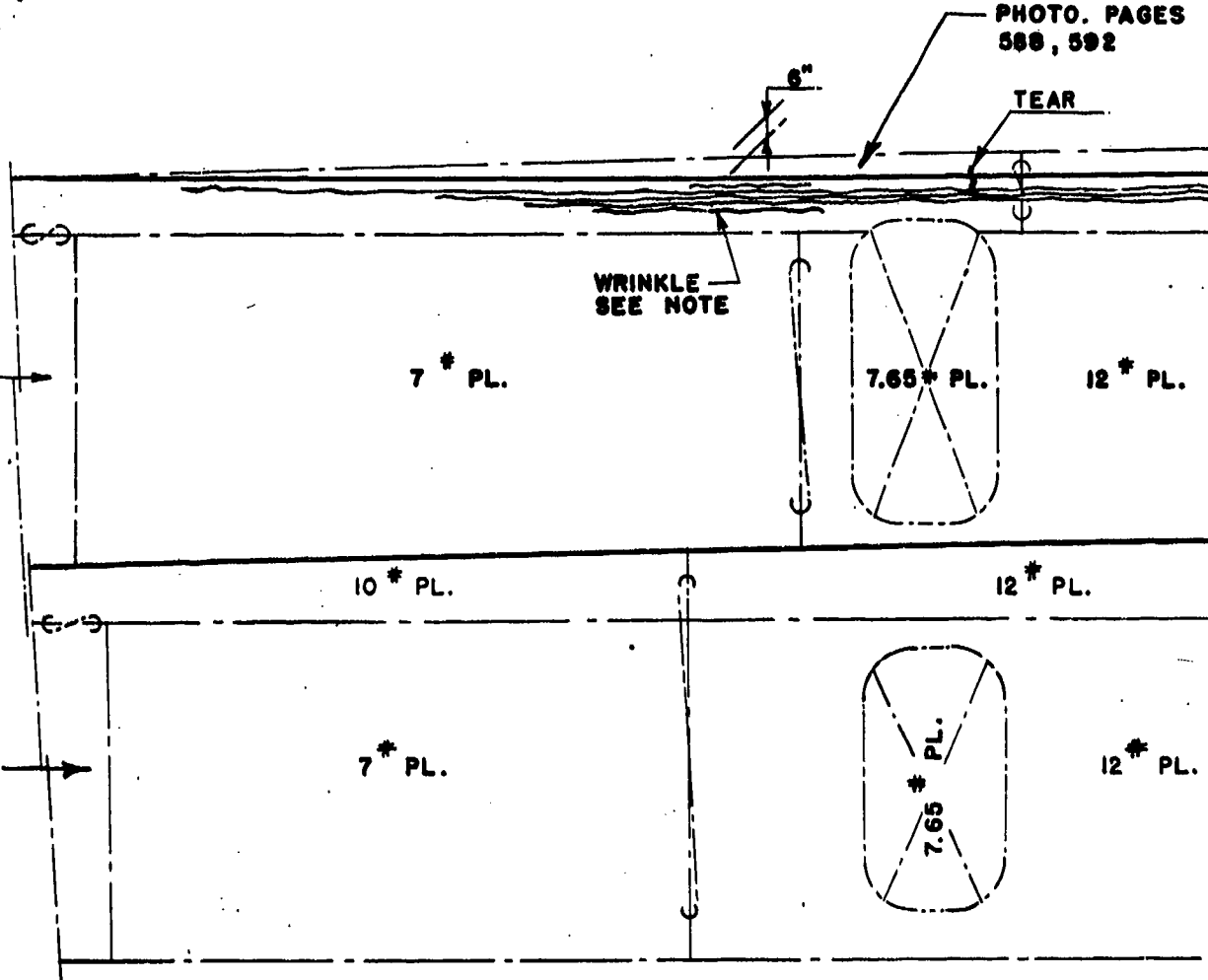
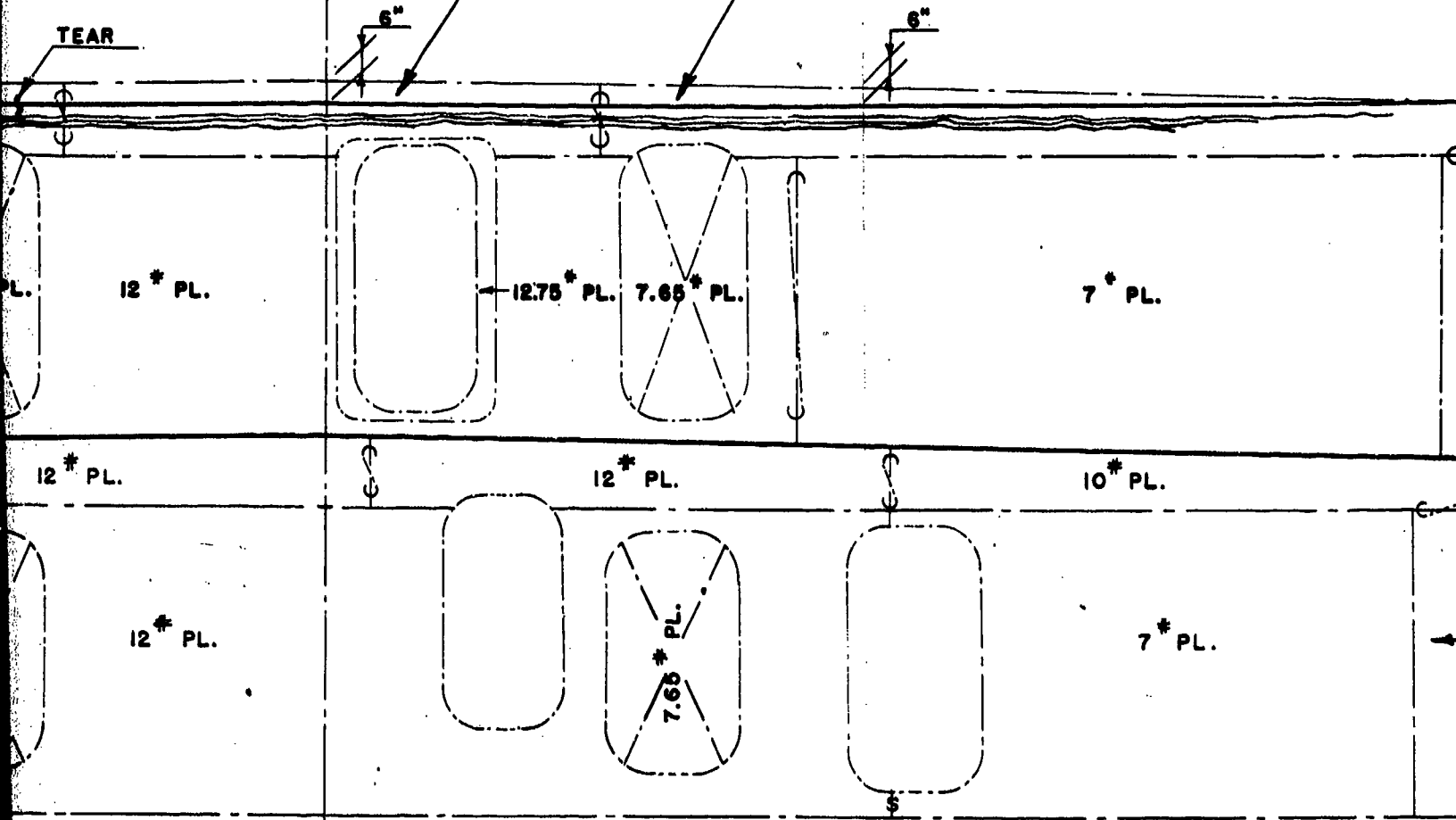

PHOTO. PAGES
588, 592

PHOTO. PAGES
590, 591

PHOTO. PAGES 587, 589

TEAR



RANSV. O.T. & W.T. BHD. 49
LOOKING FORD.

PAGE

2

NOTE:
NO. OF LINES INDICATE DEPTH
OF WRINKLE IN PLATING (INCHES).

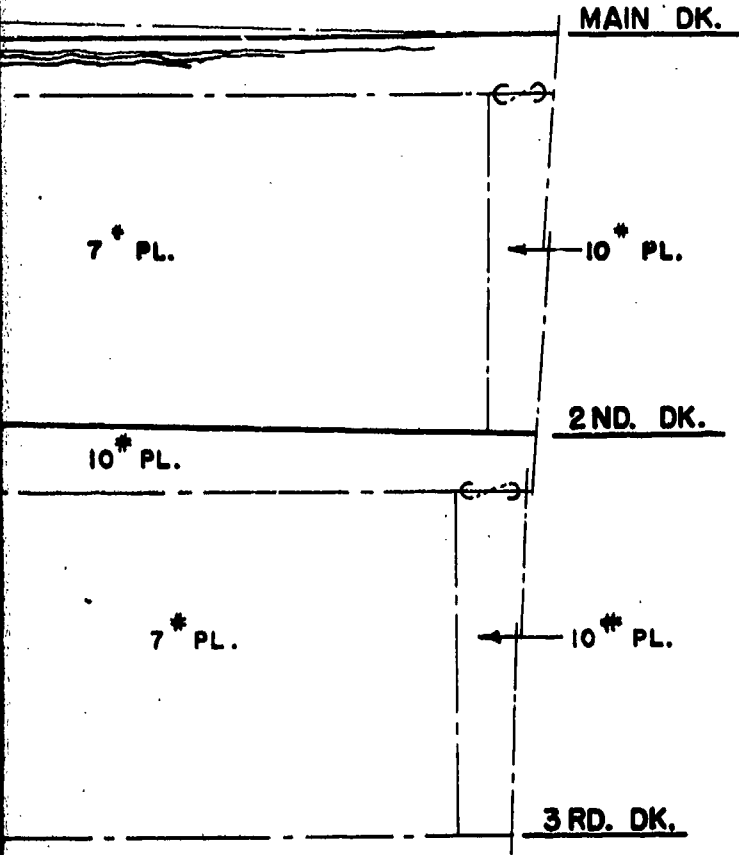

STBD.

----- BEFORE TEST
----- AFTER TEST

SECRET

NAVY DEPT. BUREAU OF S
MAIN & 2ND. DECK DEFLEC
TRANSVERSE BULKHEAD FR.

TEST A

3

PORT

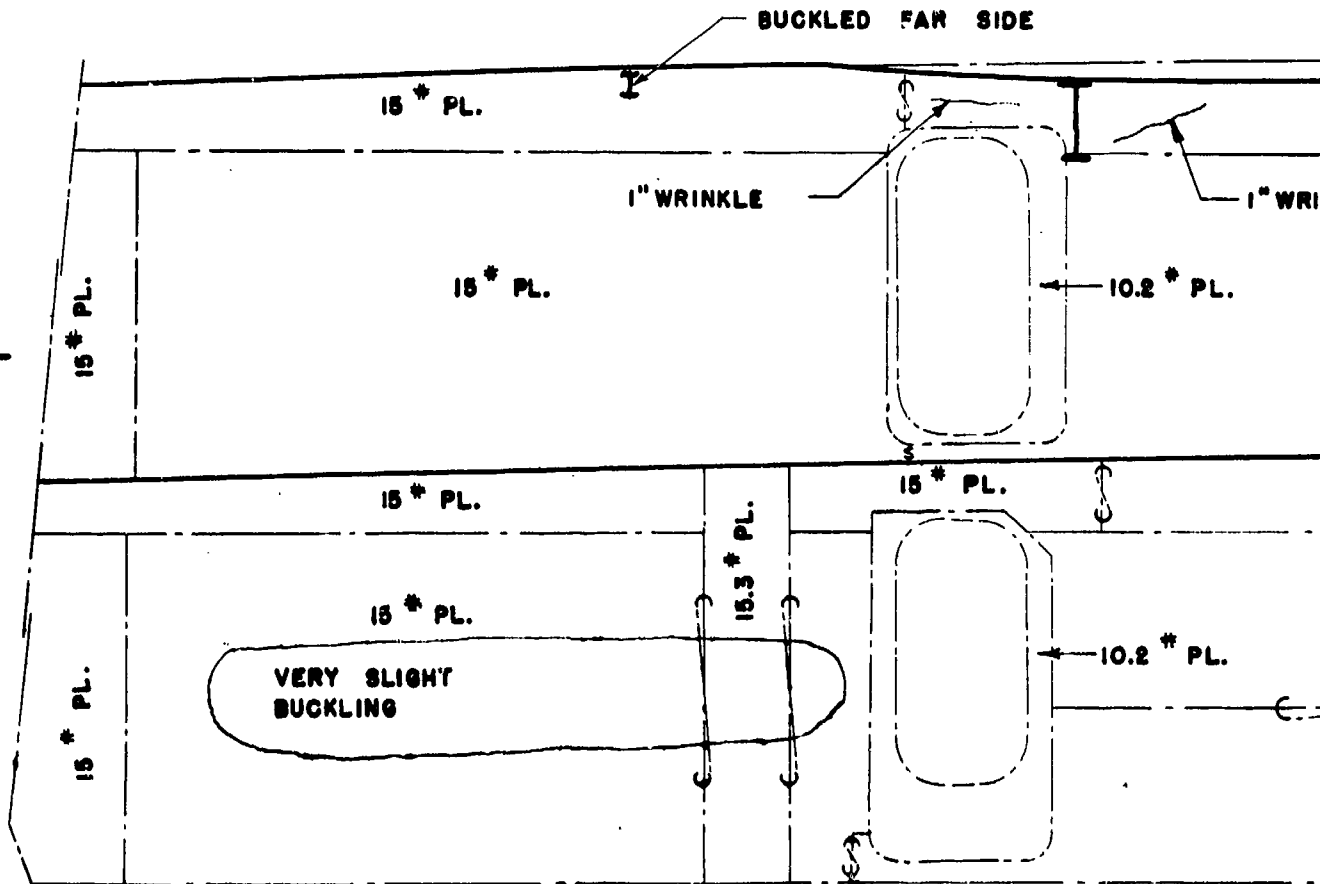

TRANSV.
LO

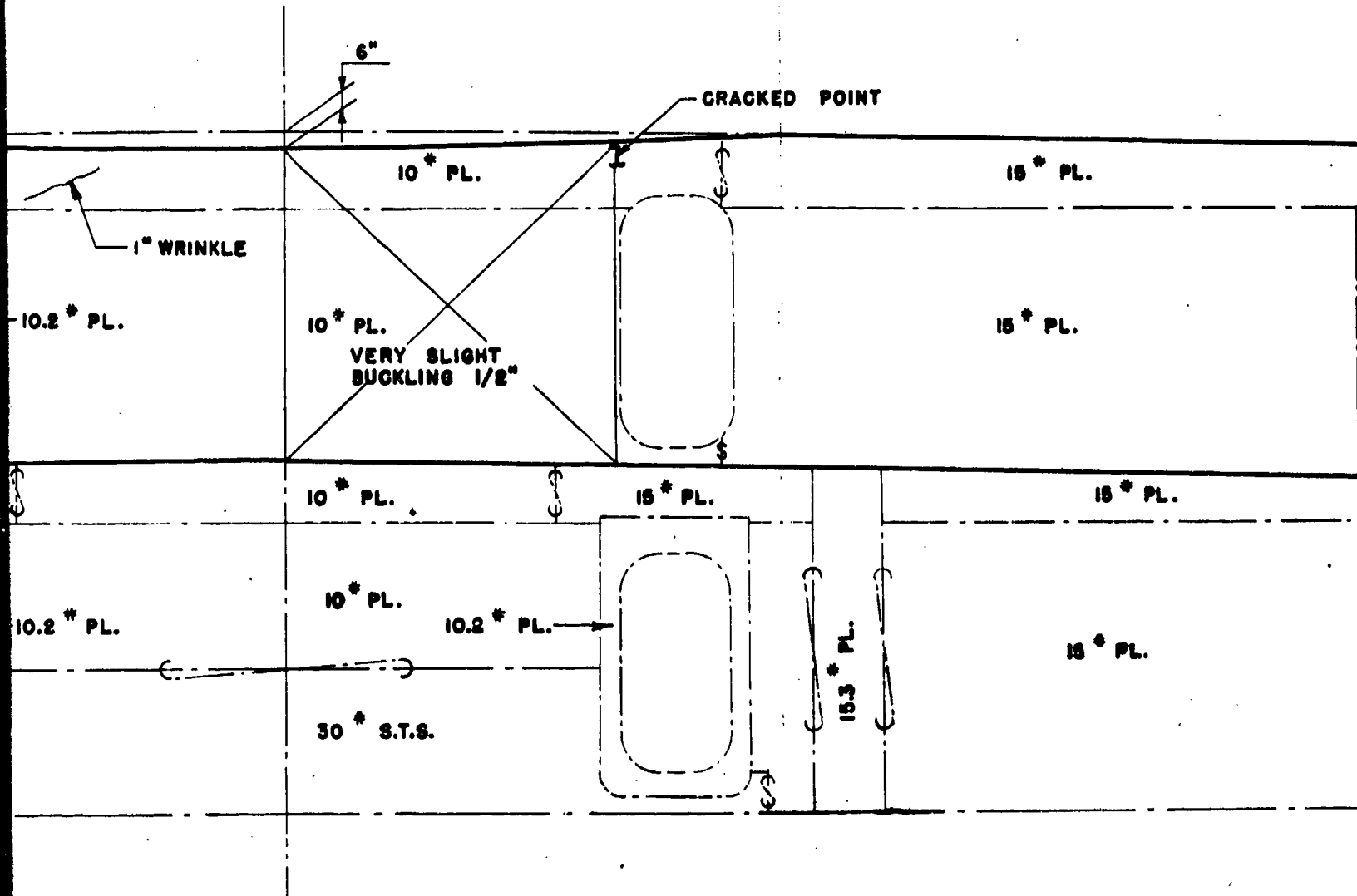

TRANSV. O.T. & W.T. BHD. 57
 LOOKING FORD.

2

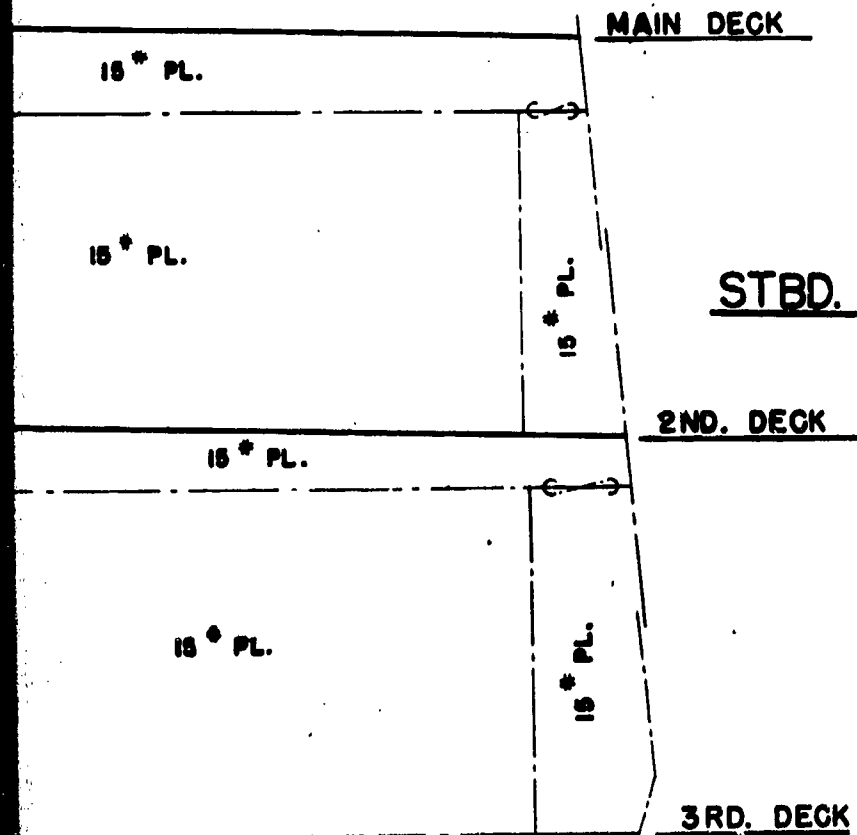

----- BEFORE TEST
 ----- AFTER TEST

SECRET

NAVY DEPT. BUREAU OF S

MAIN & 2ND. DECK DEFLECT
 TRANSVERSE BULKHEAD FR. 5

TEST A

3

STBD.

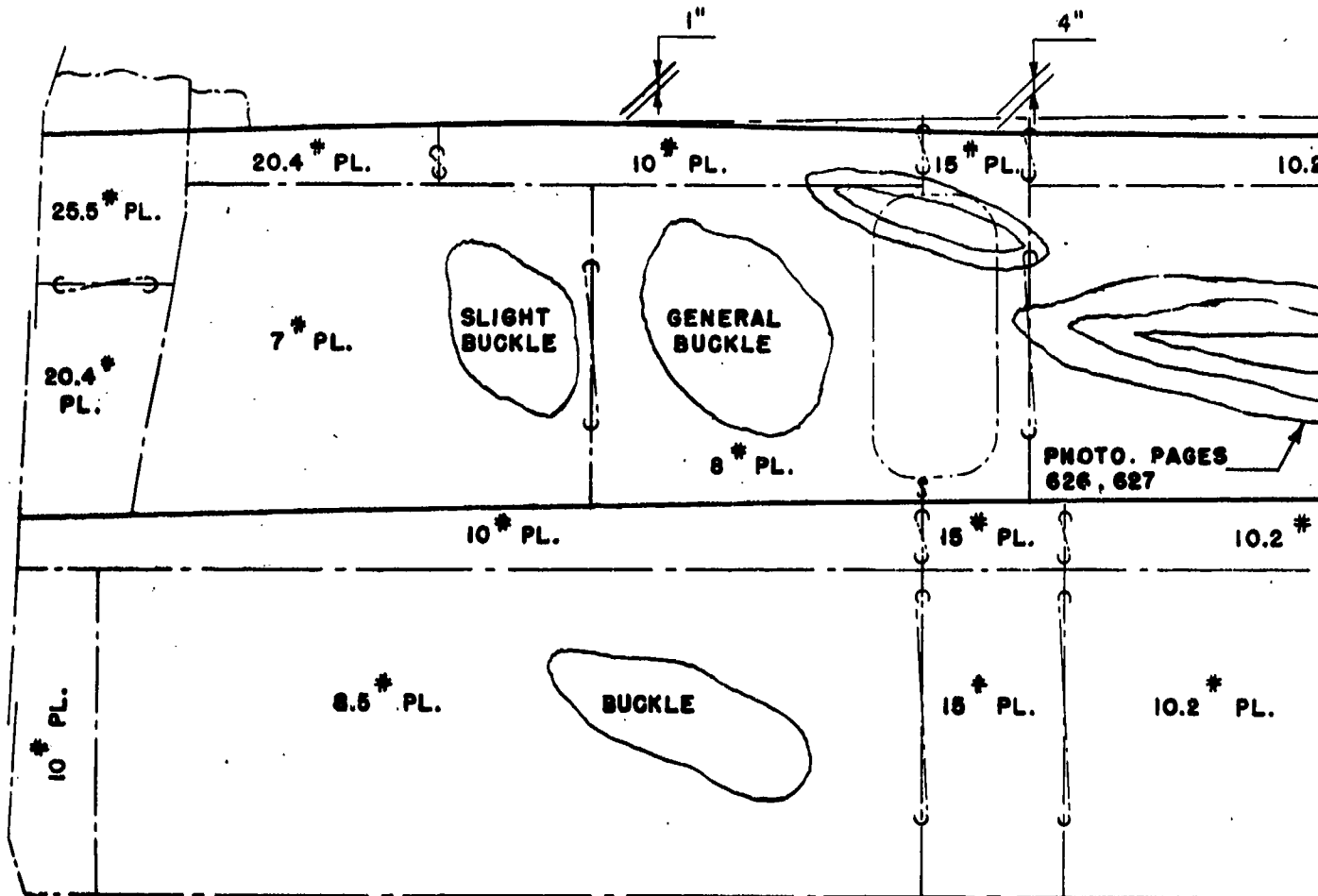

TRANSV. OT.
LOOKI

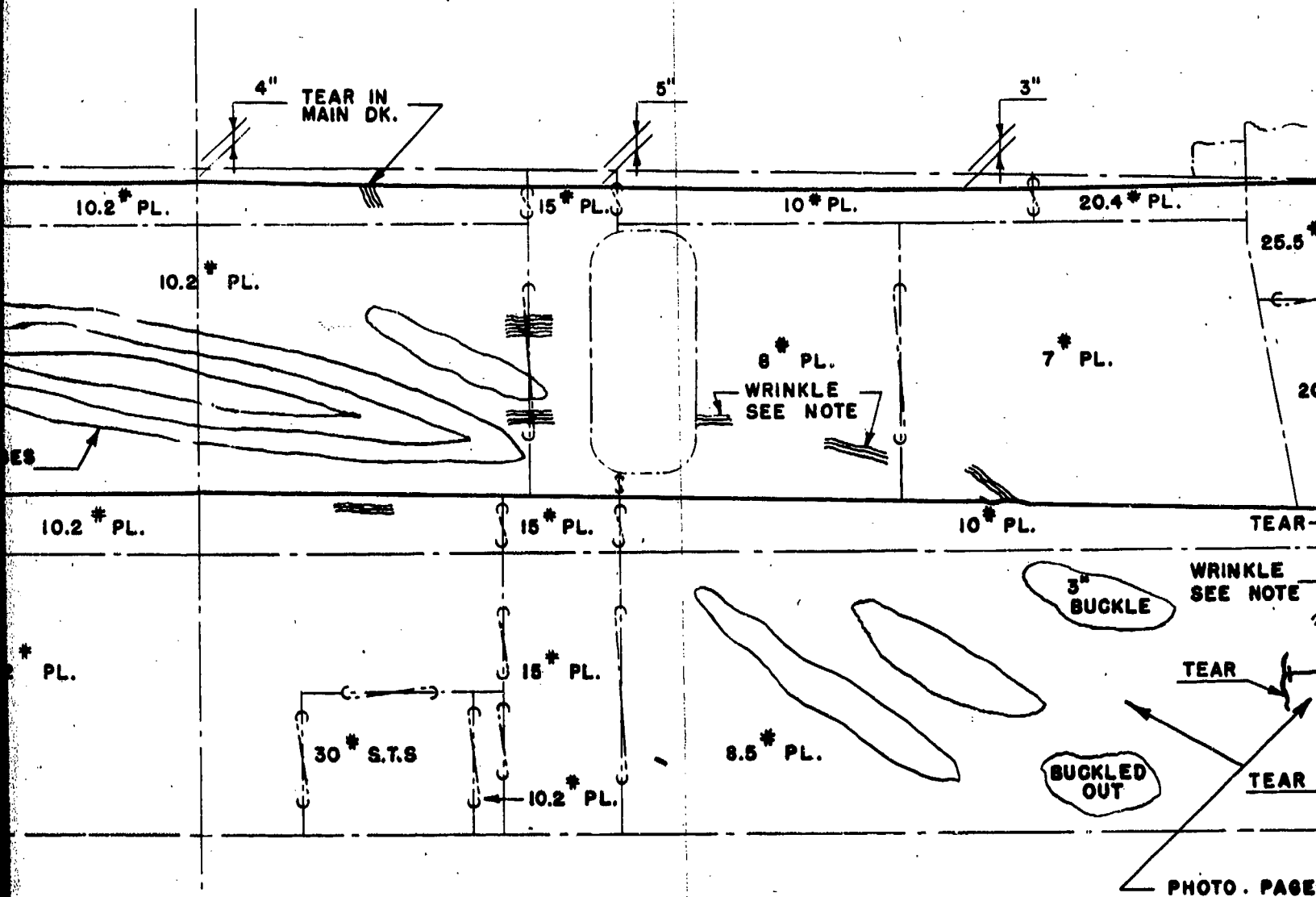

V. OT. & W.T. BHD. 113
 LOOKING AFT.

2

NOTE:
 NO. OF LINES INDICATE DEPTH
 OF WRINKLE IN PLATING (INCHES).

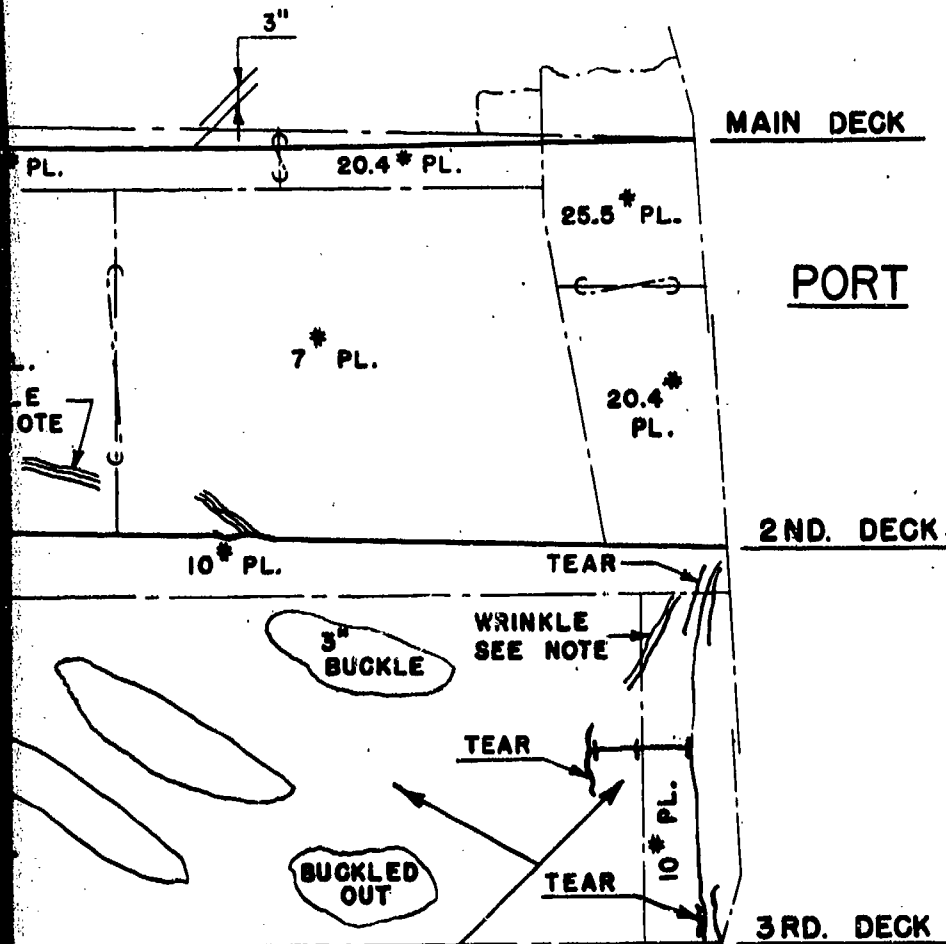

----- BEFORE TEST
 _____ AFTER TEST

PHOTO. PAGES 668-670

SECRET

NAVY DEPT. BUREAU OF
 MAIN & 2ND. DECK DEFLECTED
 TRANSVERSE BULKHEAD

TEST A

PAGE 234 OF 280

U.S.S. INDEPENDENCE

PLATE NO. 32

3

STBD.

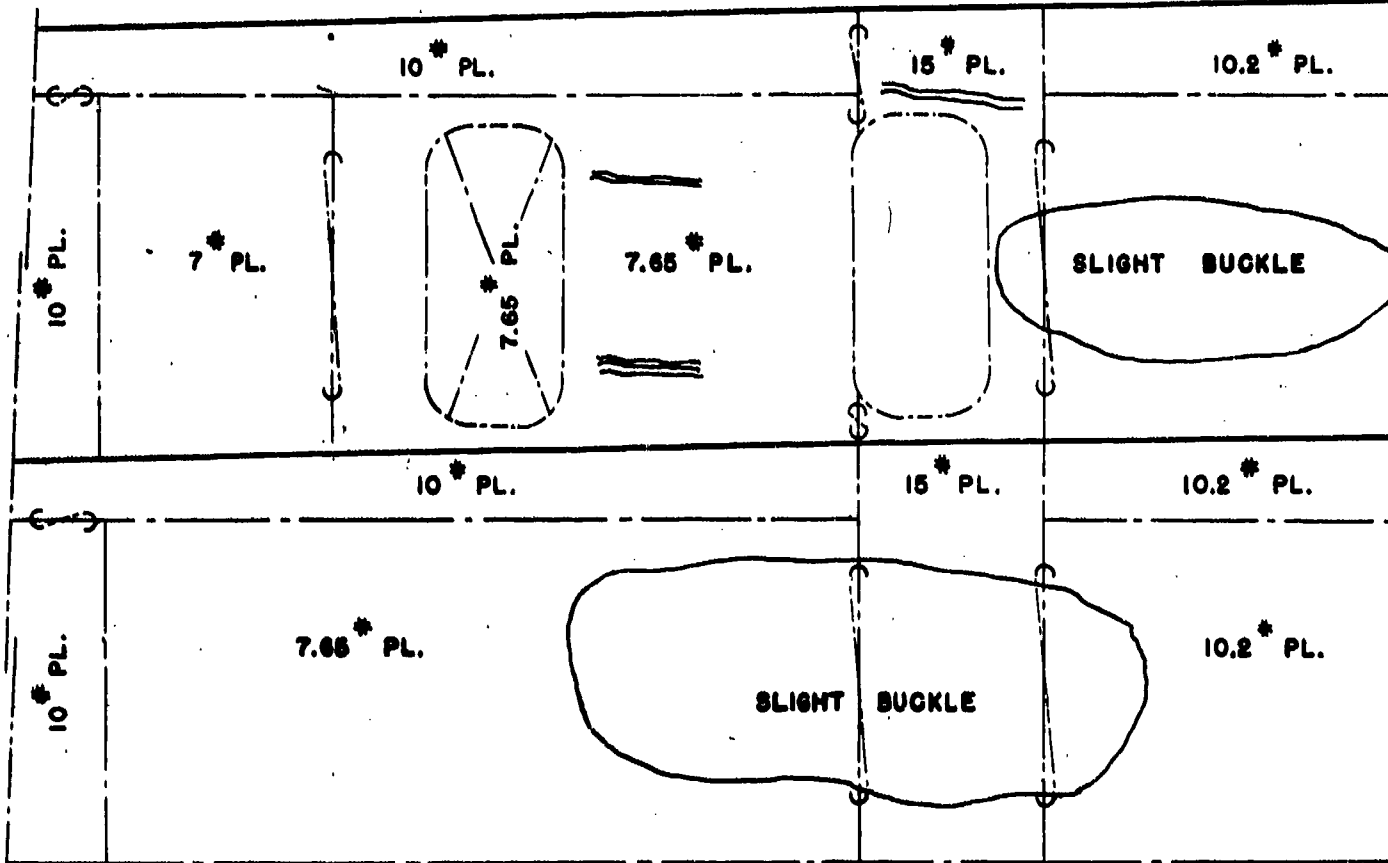

TRANSV. O.T.
LOOKI

PHOTO. PAGE 628

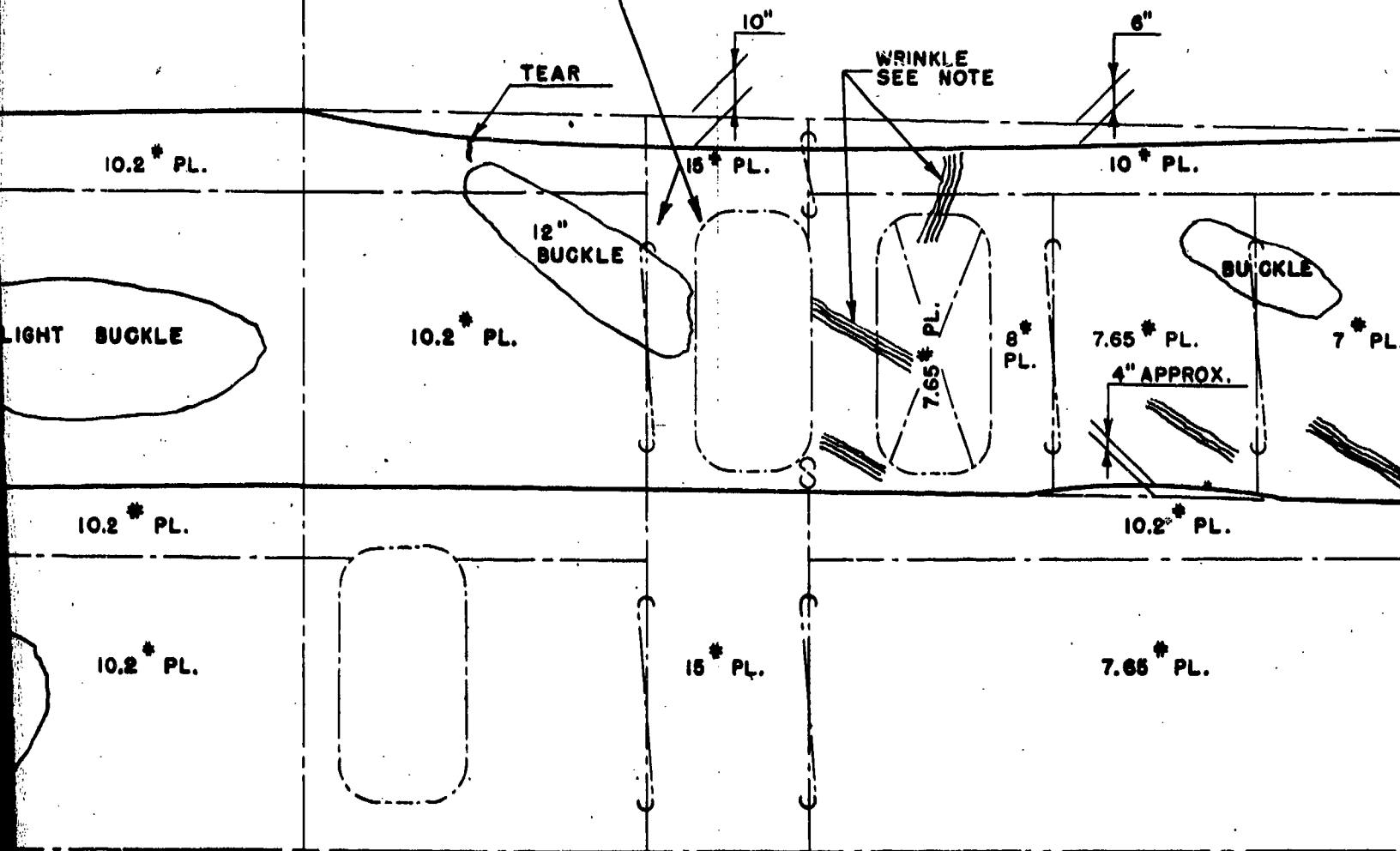

TRANSV. O.T. & W.T. BHD. 119
LOOKING AFT

2

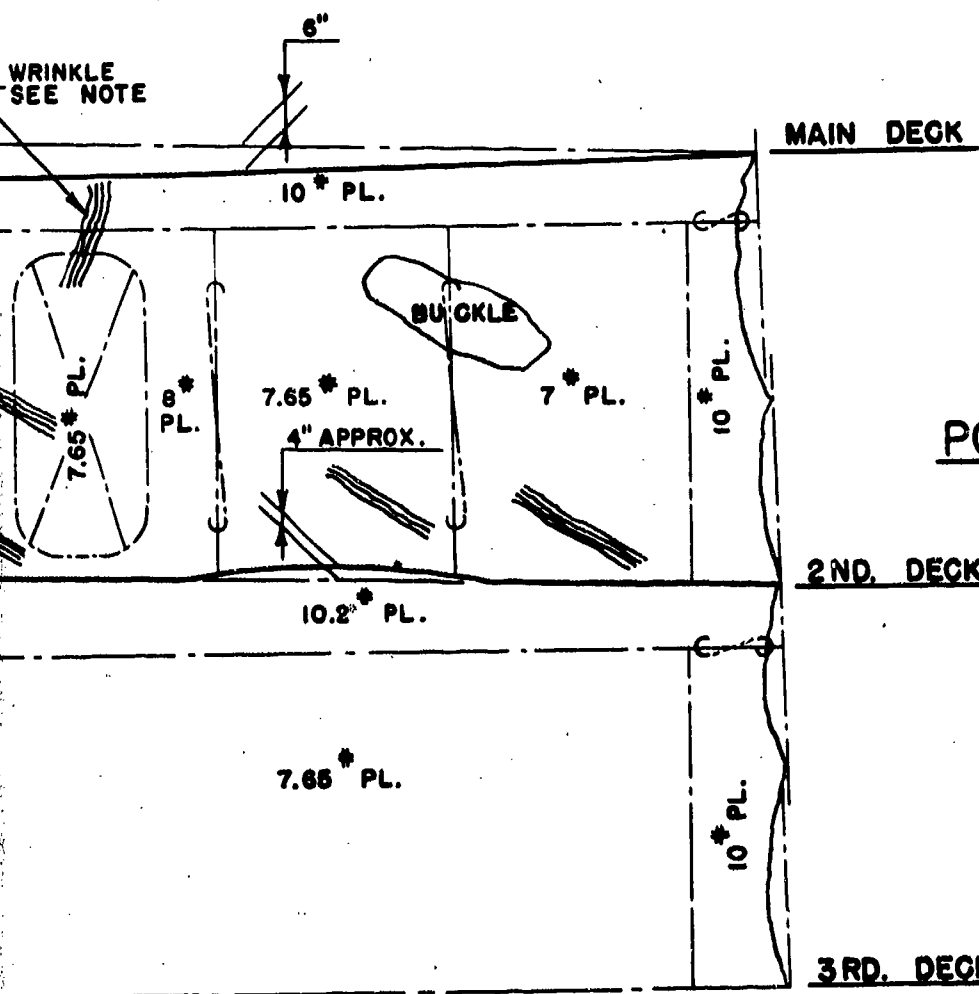

NOTE:
 NO. OF LINES INDICATE DEPTH
 OF WRINKLE IN PLATING (INCHES).

PORT

----- BEFORE TEST
 _____ AFTER TEST

SECRET

NAVY DEPT. BUREAU OF SHIPBUILDING
 MAIN & 2ND. DECK DEFLECTOR
 TRANSVERSE BULKHEAD FR
 TEST A

3

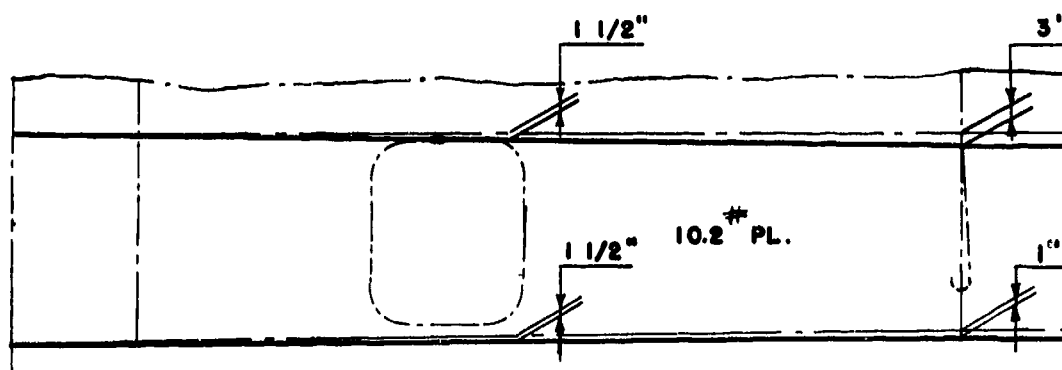
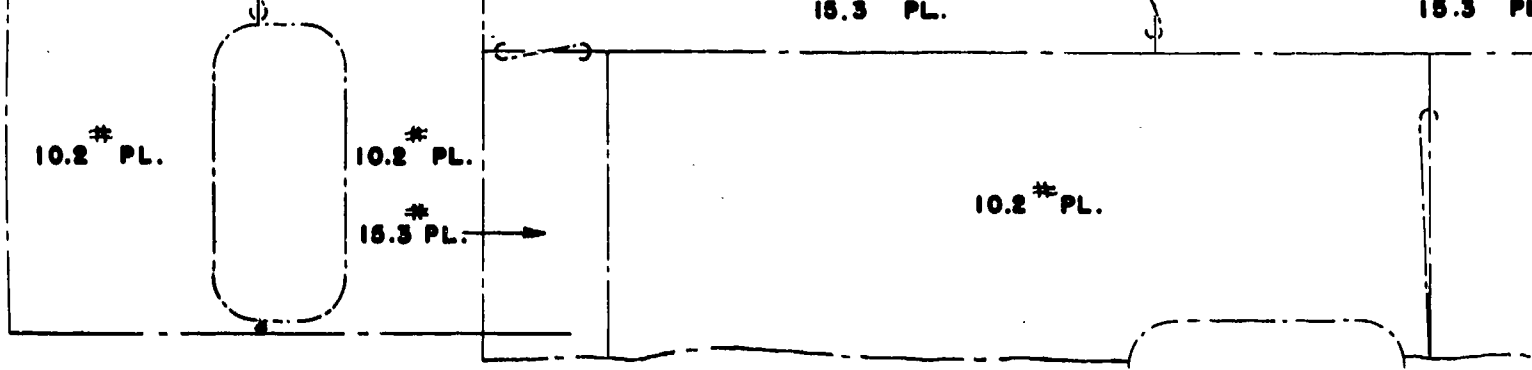

STBD.

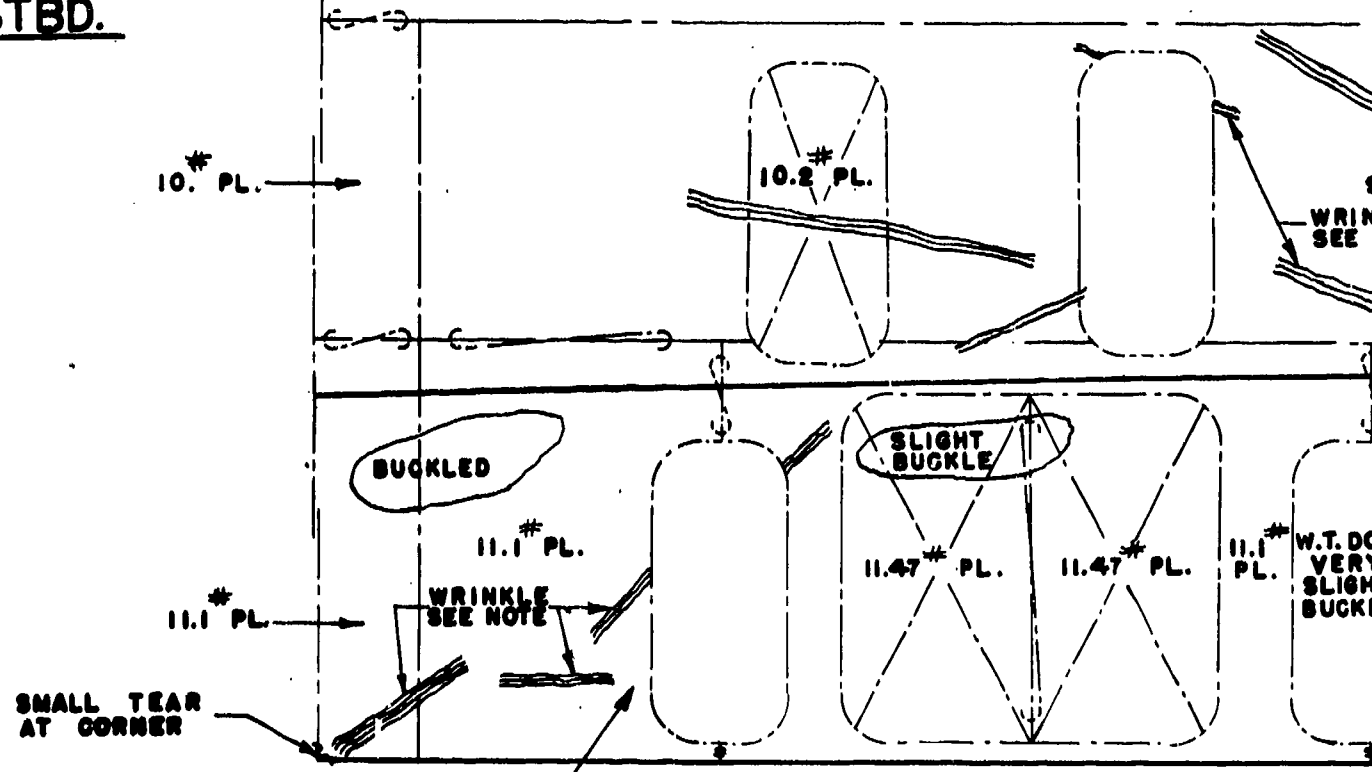

PHOTO. PAGE 679

TF

10.2* PL.

10.2** PL.

3"

3"

5"

1"

10.2* PL.

10.2* PL.

10* PL.

9* PL.
WRINKLE
SEE NOTE

15 PL.

9* PL.
PHOTO. PAGE 634

WRINKLE
SEE NOTE

PHOTO. PAGE 635

PL.

11.1* PL.
W.T. DOOR
VERY
SLIGHT
BUCKLE

SLIGHT
BUCKLE

11.47* PL.

11.1* PL.

SLIGHT BOW

WRINK
SEE

TRANS. WT. & O.T. BHD. 126
LOOKING AFT.

PAGE 23

2

15.3 # PL.

10.2 # PL.

10.2 # PL.

10.2 # PL.

15.3 # PL.

NOTE:

NO. OF LINES INDICATES DEPTH OF WRINKLE IN PLATING (INCHES).

1"

HANGER DECK

10.2 # PL.

1"

1"

MAIN DECK

PORT

PHOTO. PAGE 635

WRINKLE SEE NOTE

10 # PL.

2 1/2"

BEFORE T

AFTER T

2 ND. DECK

11.1 # PL.

TEAR

SECRET

NAVY DEPT.

BUREAU OF

FLIGHT, HANGER, MAIN & 2
DECK DEFLECTION
TRANSV. BULKHEAD, FR.

TEST A

WRINKLE SEE NOTE

11.1 # PL.

3 RD. DECK

U.S.S. INDEPENDENCE

CV

PAGE 236 OF 280

PLATE NO. 34

3

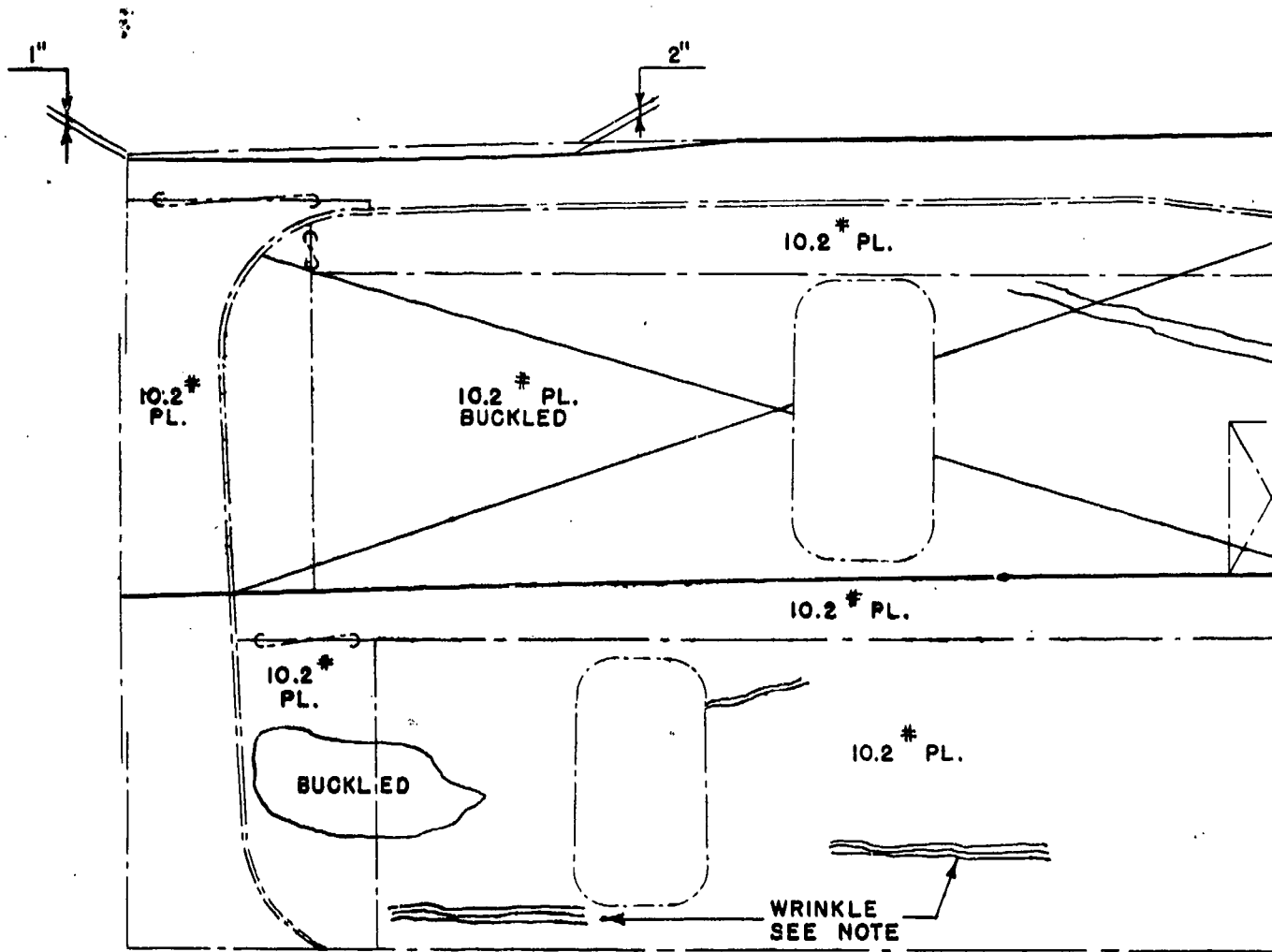

STBD.

TRANSV.
LOOK

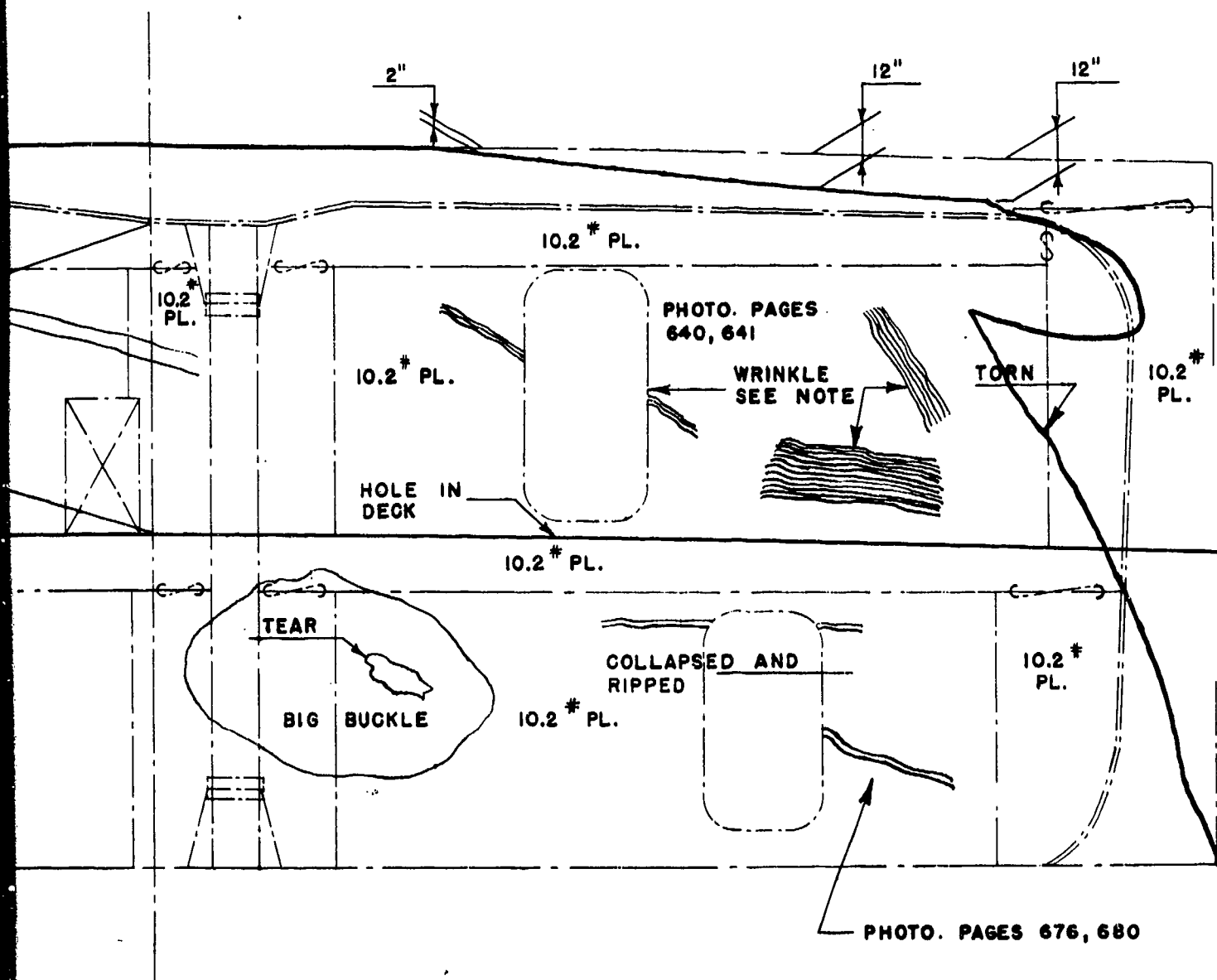

MAIN DECK

2ND. DECK

3RD. DECK

PHOTO. PAGES 640, 641

PHOTO. PAGES 676, 680

NSV. W.T. BHD. 132
LOOKING AFT.

PAGE 237 OF

2

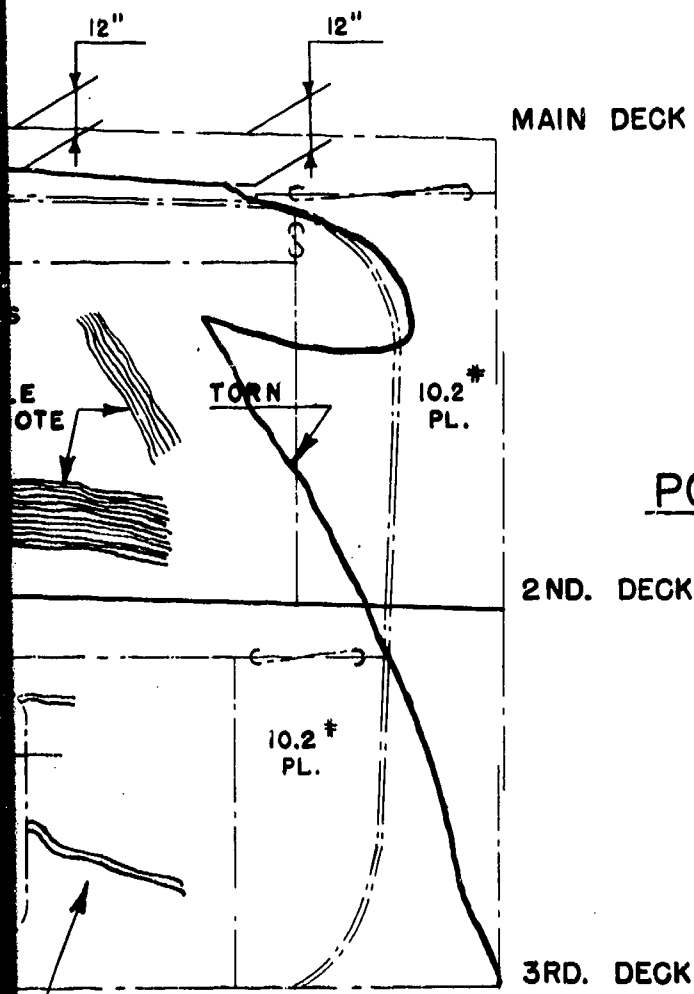

NOTE:
 NO. OF LINES INDICATE DEPTH
 OF WRINKLE IN PLATING (INCHES).

----- BEFORE TEST
 _____ AFTER TEST

PORT

PHOTO. PAGES 676, 380

SECRET

NAVY DEPT. BUREAU OF S
 MAIN & 2ND. DECK DEFLECT
 TRANSVERSE BULKHEAD FR
 TEST A
 U.S.S. INDEPENDENCE CVL

PAGE 237 OF 280

PLATE NO. 35

3

PHOTO. PAGE 138

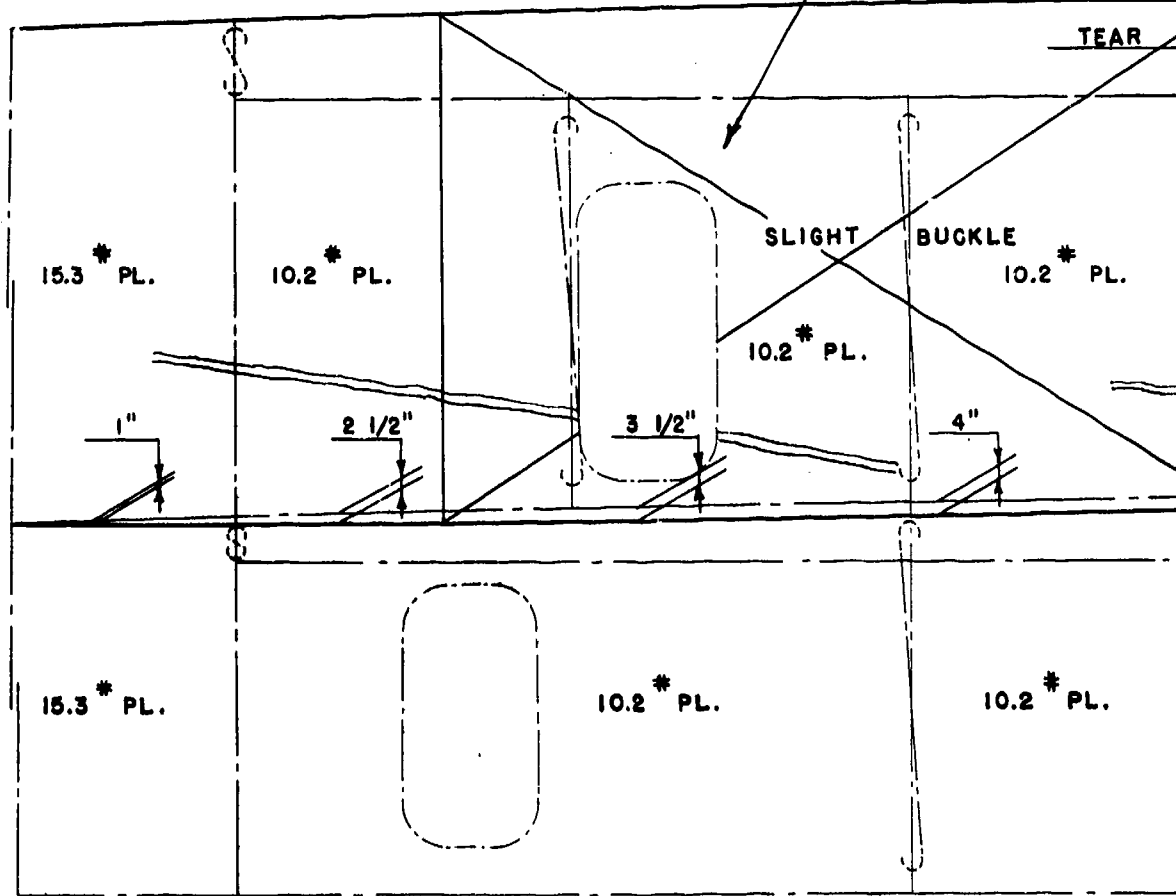

STBD.

TRANS
LOOK

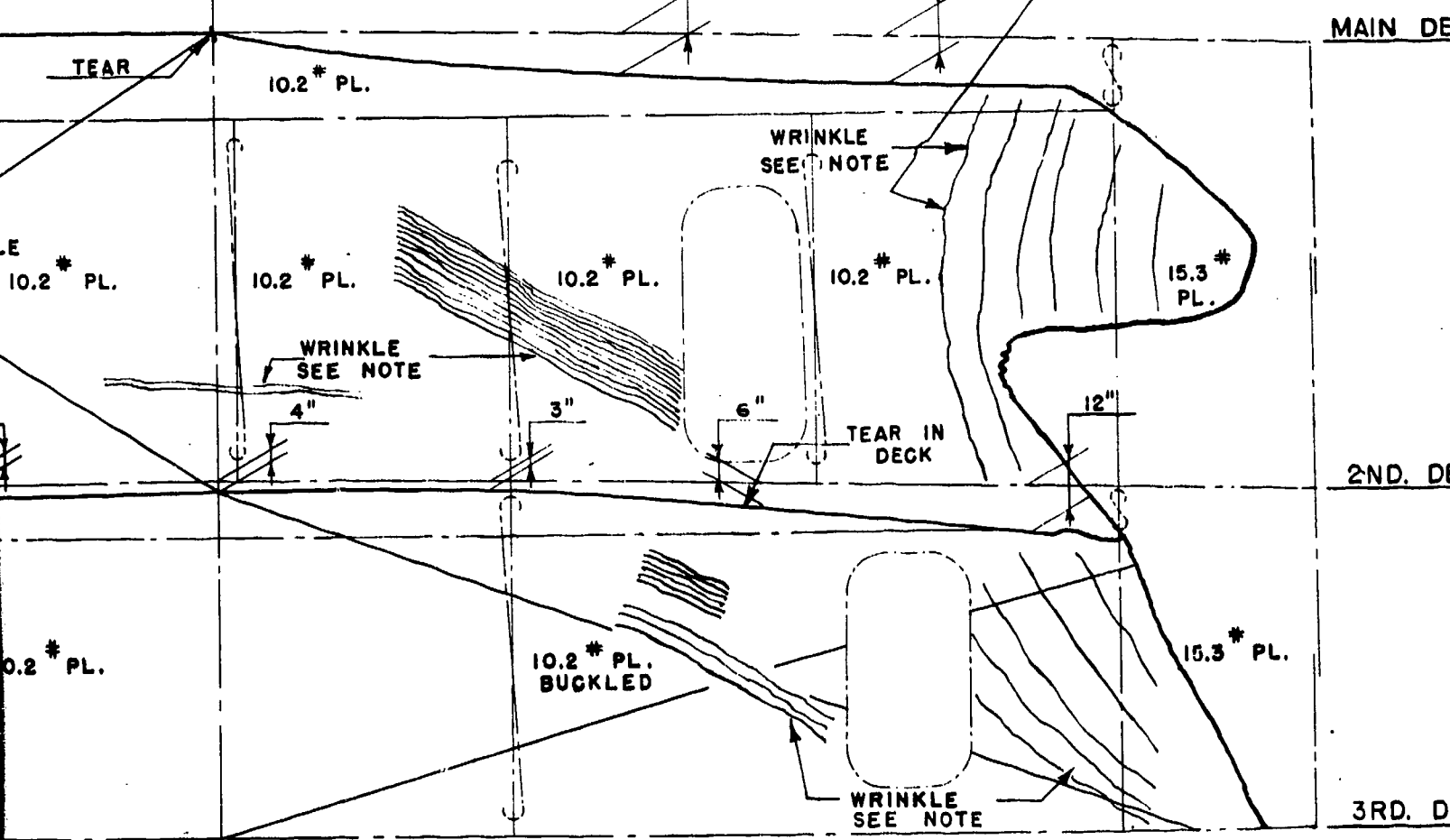

TRANSV. BHD. 138
LOOKING AFT.

2

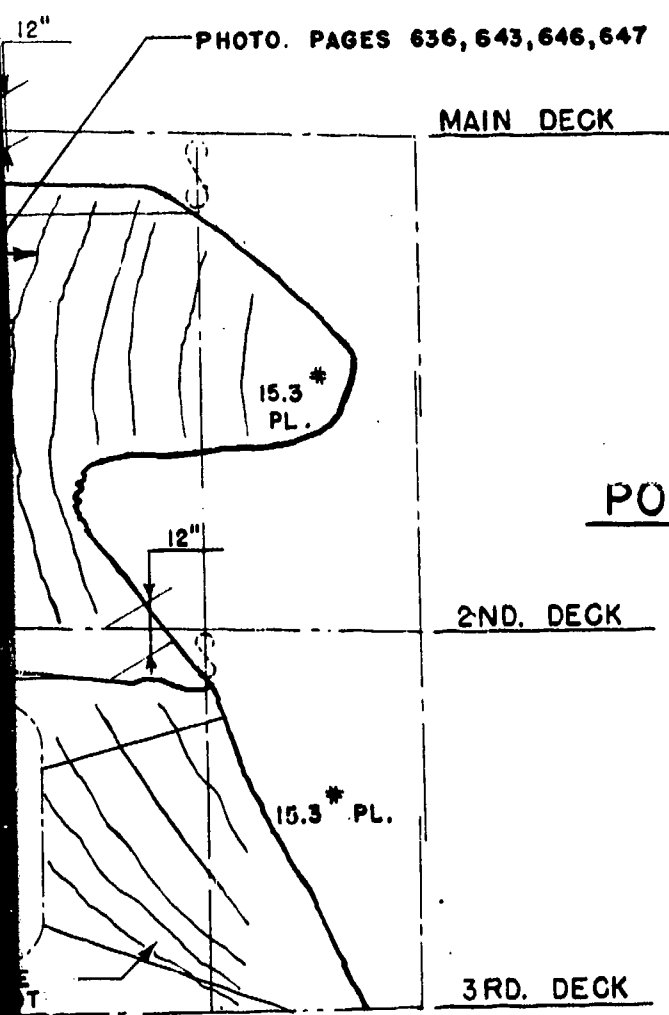

NOTE:
 NO. OF LINES INDICATES DEPTH
 OF WRINKLE IN PLATING (INCHES).

----- BEFORE TEST
 _____ AFTER TEST

PORT

SECRET

NAVY DEPT. BUREAU OF S

MAIN & 2ND. DECK DEFLECT
 TRANSVERSE BULKHEAD FR

TEST A

PAGE 238 OF 280

U.S.S. INDEPENDENCE

CV

PLATE NO.36

3

PHOTO. PAGE 652

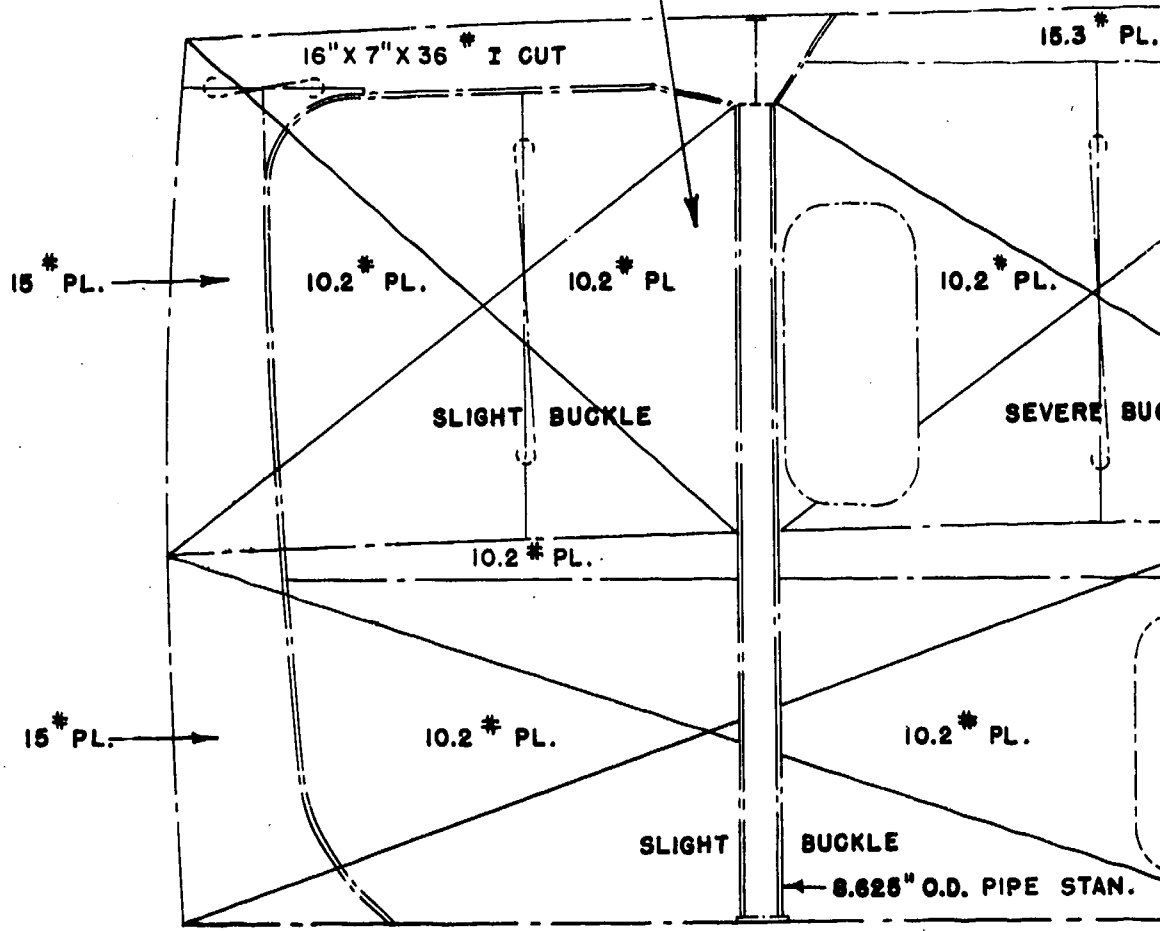

STBD.

TRANSV
LO

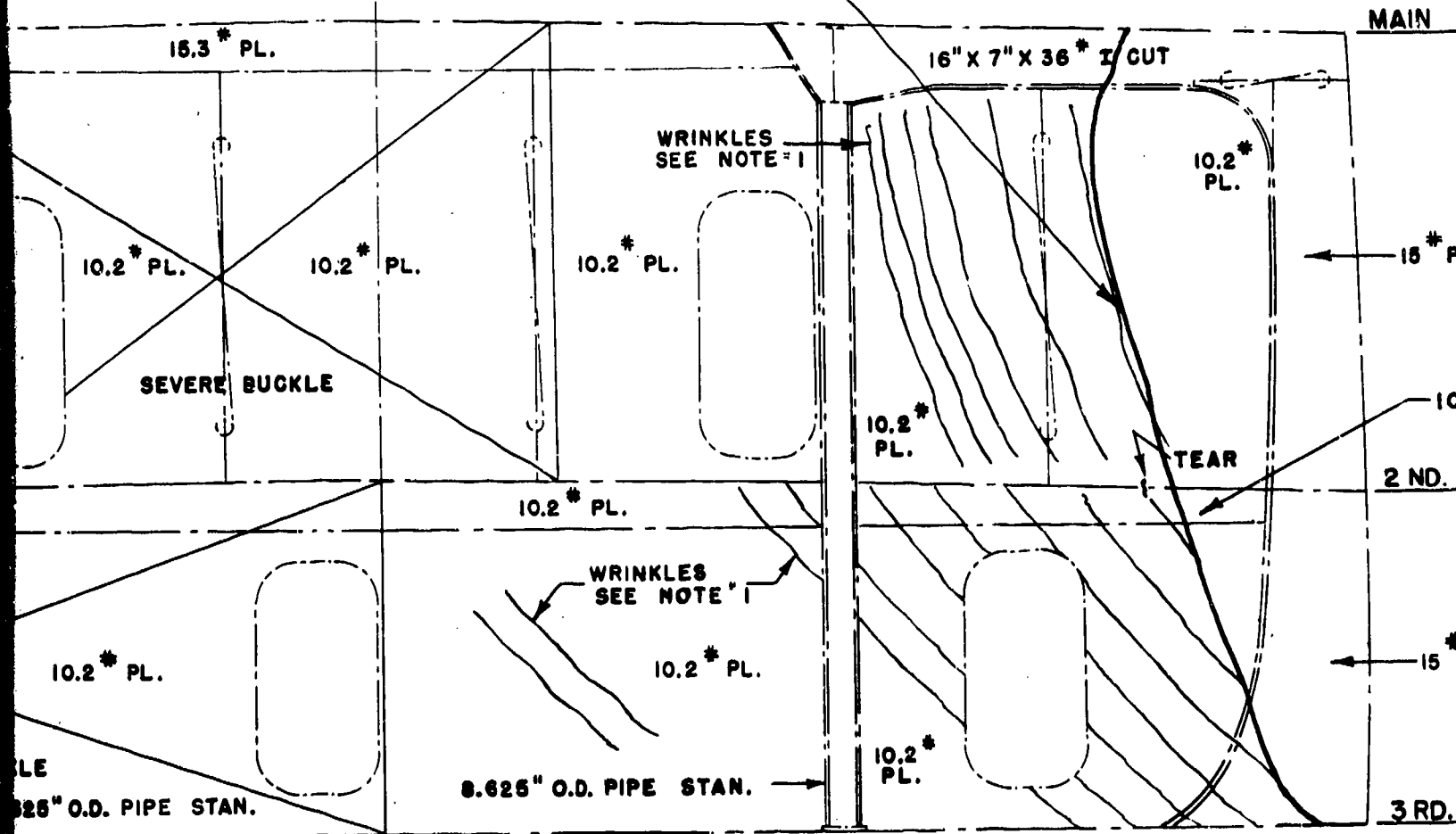

TRANSV. W.T. BHD. 144
LOOKING AFT.

J-1

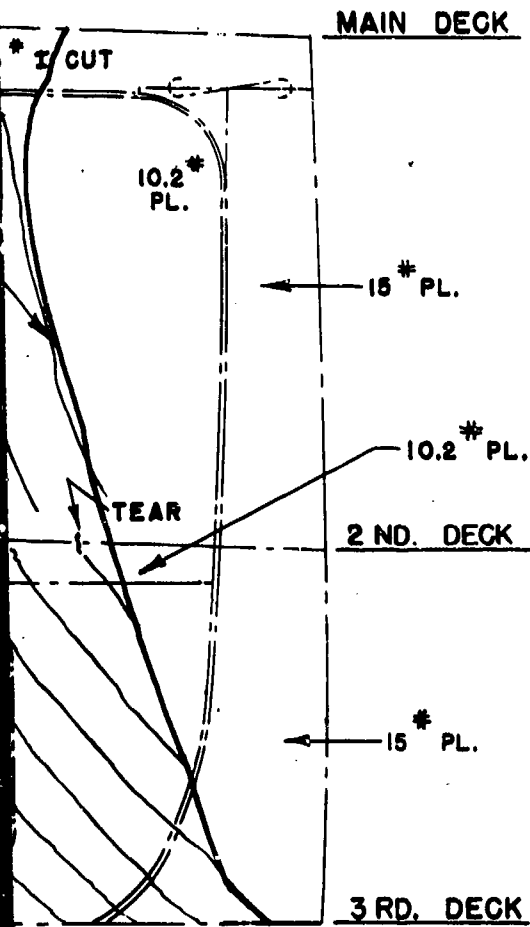

PORT

NOTE:

1. NO. OF LINES INDICATES DEPTH OF WRINKLE IN PLATING (INCHES).
2. NO DATA AVAILABLE REGARDING DECK DEFLECTION. SHELL DAMAGE INDICATED TAKEN FROM PHOTOS.

----- BEFORE TEST
 ----- AFTER TEST

SECRET

NAVY DEPT. BUREAU OF
 MAIN & 2ND. DECK DEFLEC
 TRANSVERSE BULKHEAD FR

TEST A

3

STBD.

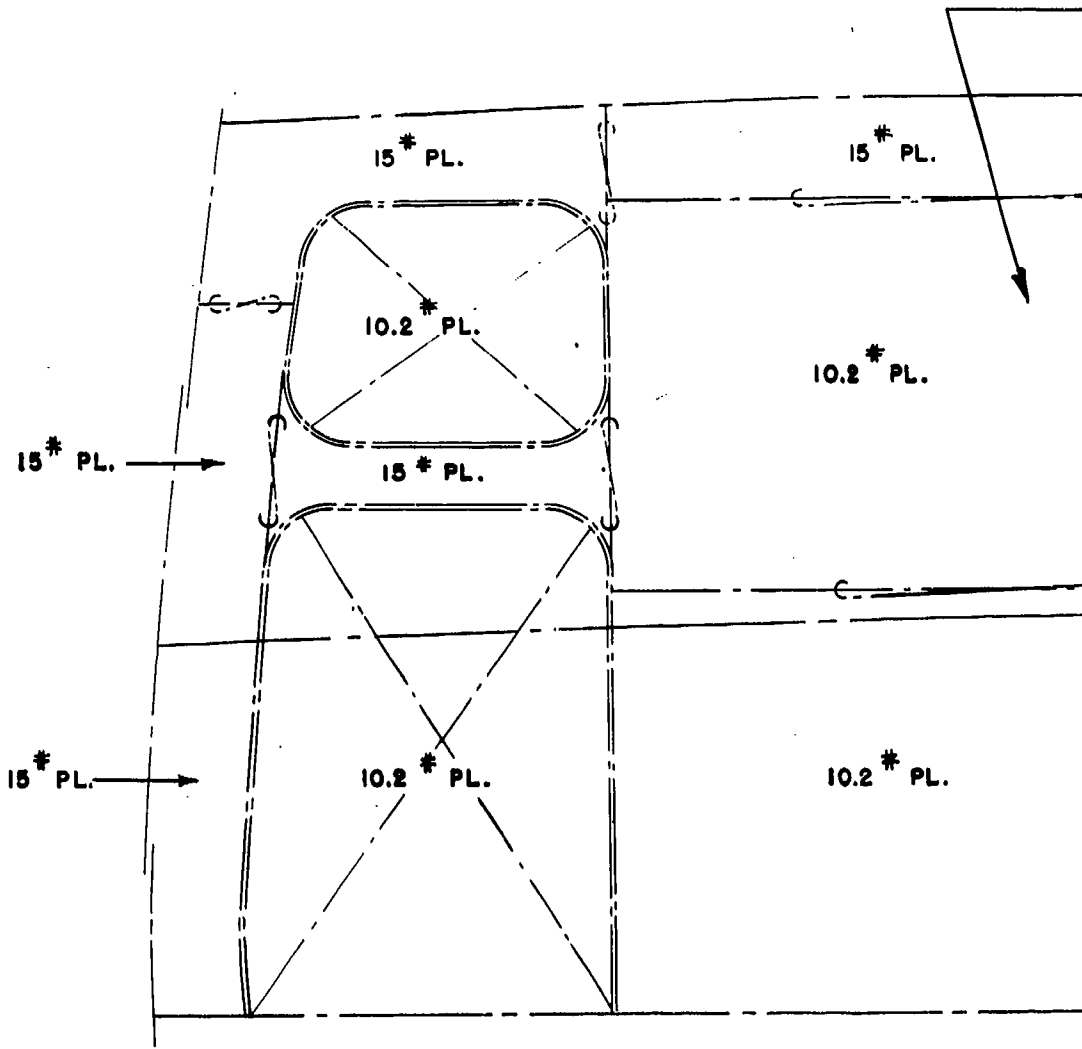

TRANSV. N.T.
LCOI

PHOTO. PAGE 653

MAIN DECK

15 * PL.

10.2 * PL.

10.2 * PL.

15 * PL.

15 * PL.

2 ND. DECK

10.2 * PL.

15 * PL.

PHOTO. PAGE 682

3RD. DECK

SV. N.T. & W.T. BHD. 147
LOOKING AFT.

2

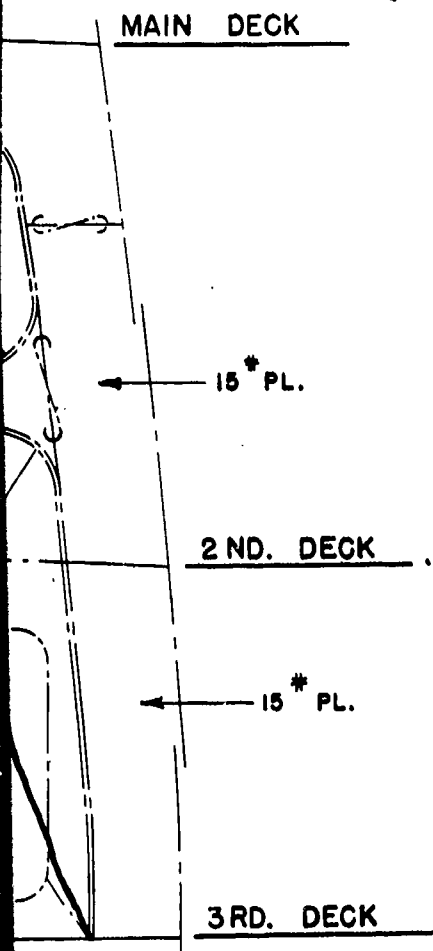

PORT

NOTE:
 NO DATA AVAILABLE REGARDING DECK
 BULKHEAD DEFLECTION. SHELL DAMAGE
 INDICATED TAKEN FROM PHOTOS.

----- BEFORE TEST
 _____ AFTER TEST

SECRET

NAVY DEPT. BUREAU OF
 MAIN & 2ND. DECK DEFLEC
 TRANSVERSE BULKHEAD FR
 TEST A
 U.S.S. INDEPENDENCE CV

3

35# PL. S.T.S.

LONG'L. # 10

30.6# PL.

12"

25.5# PL.

2ND. DECK

10.2# PL.

25# PL. S.T.S.

LONG'L. # 8

19"

15.3# PL.

3RD. DECK

10.2# PL.

25 PL. S.T.S.

LONG'L. # 6

4"

15.3# PL.

LONG'L. # 5

FR. 89

35# PL. S.T.S.

LONG'L. # 10

10.2

10.1

3" X 1/4" F.B.

2ND. DECK

10.2# PL.

10.

25# PL. S.T.S.

LONG'L. # 8

3" X 1/4" F.B.

3RD. DECK

10.

3" X 1/4" F.B.

25 PL. S.T.S.

LONG'L. # 6

10.

LONG'L. # 5

F

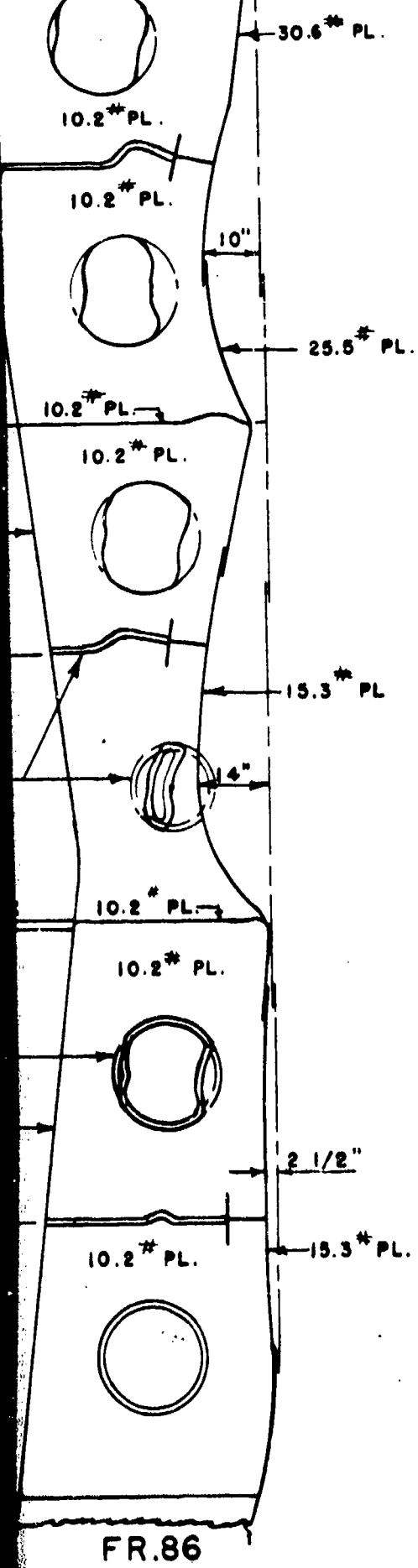

1

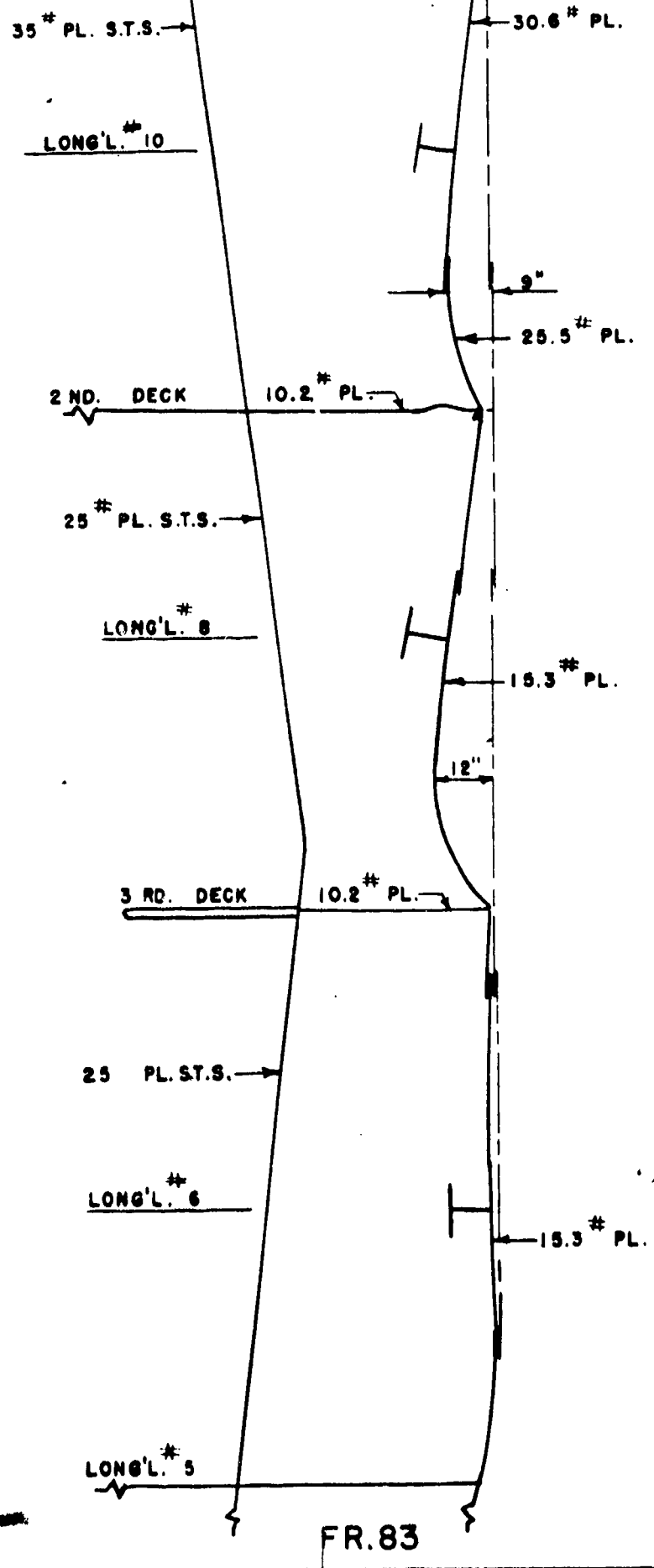

LONG'L. 10

2 ND. DECK

25 # PL. S.T.S.

LONG'L. 8

3 RD. DECK

25 # PL. S.T.S.

LONG'L. 6

LONG'L. 5

FR.80

7 1/2"

25.5 # PL.

15.3 # PL.

12"

15.3 # PL.

3

LONG'L. 10

2 ND. DECK

25 # PL. S.T.S.

LONG'L. 8

3 RD. DECK

25 # PL. S.T.S.

LONG'L. 6

LONG'L. 5

FR.77

10.2 # PL.

10.2 # PL.

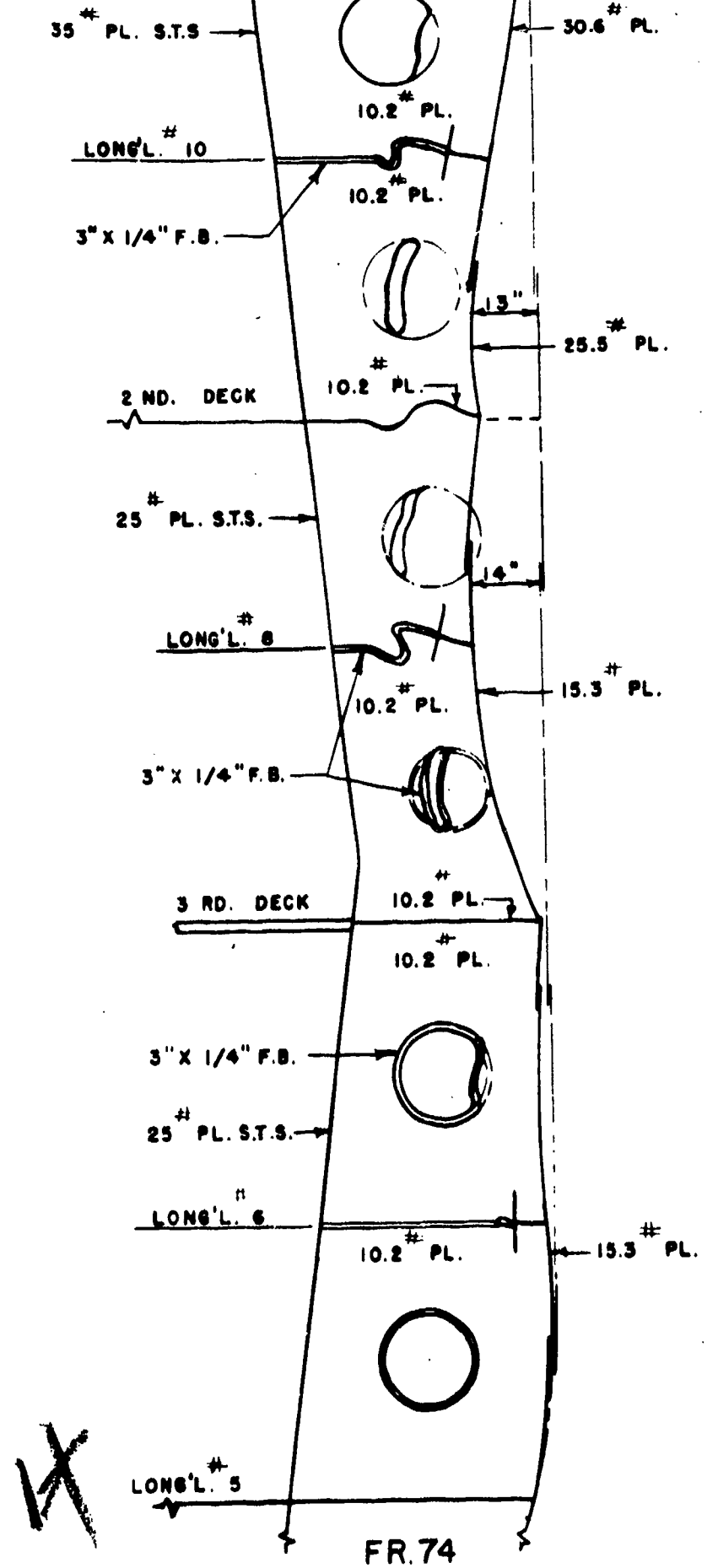
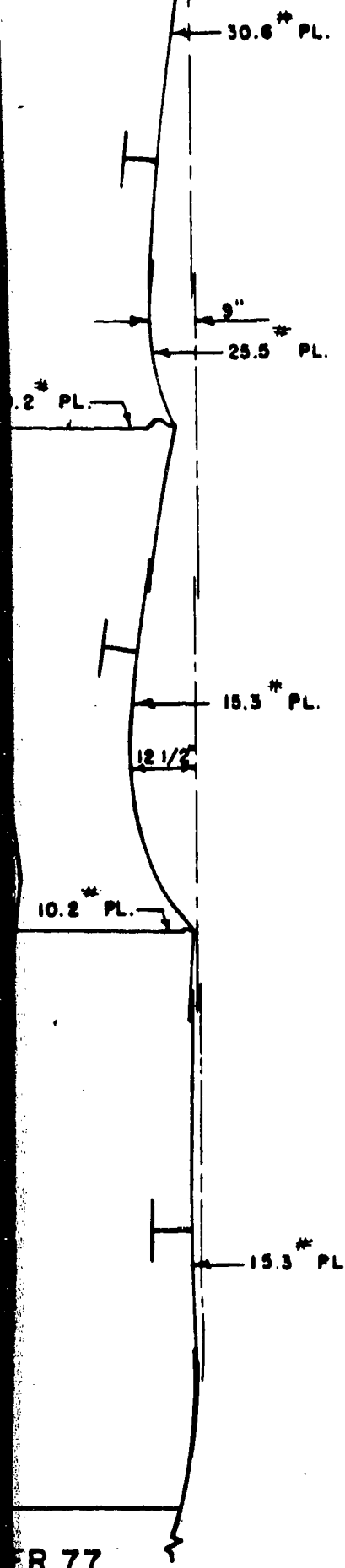

~~X~~

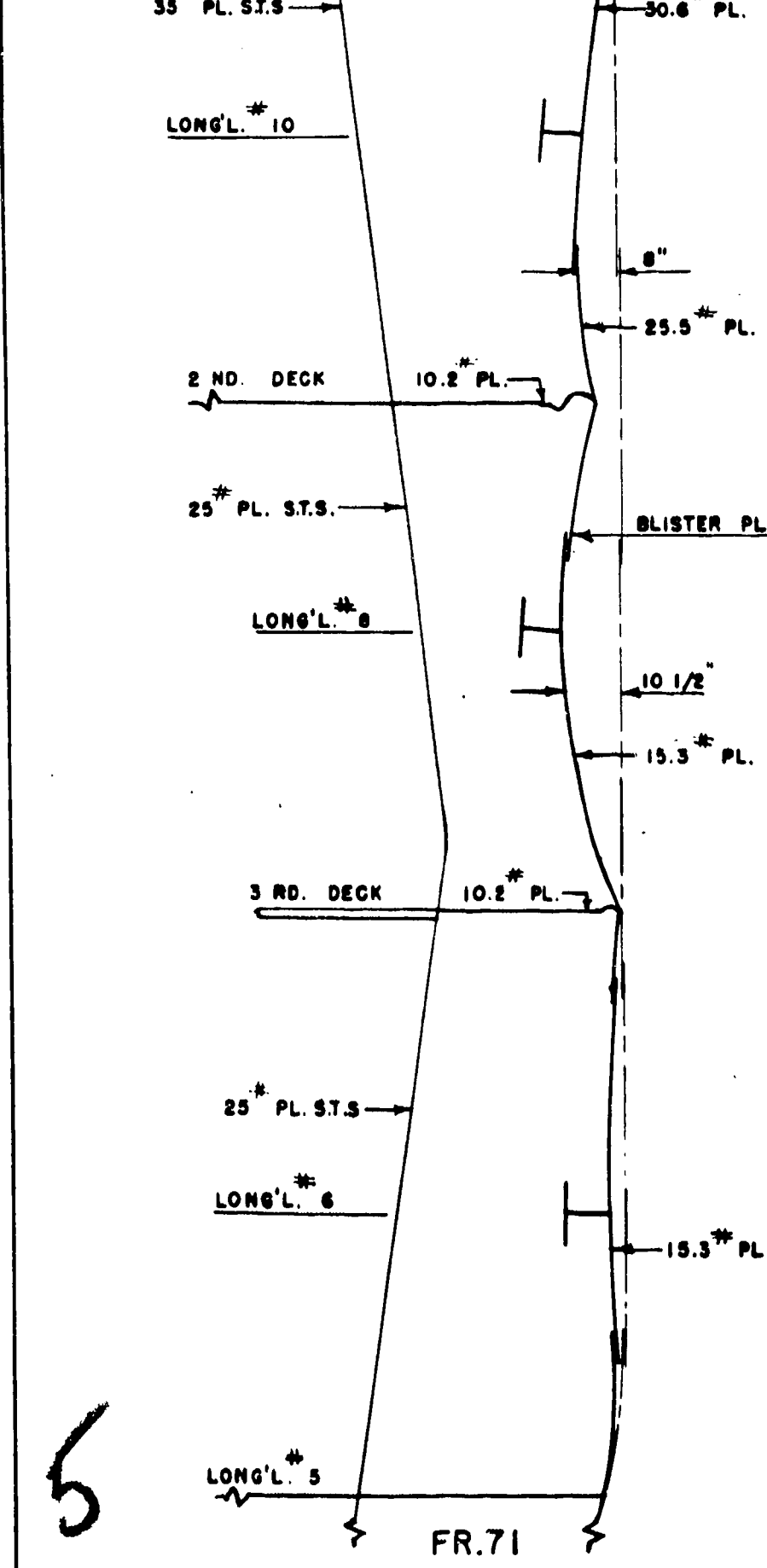
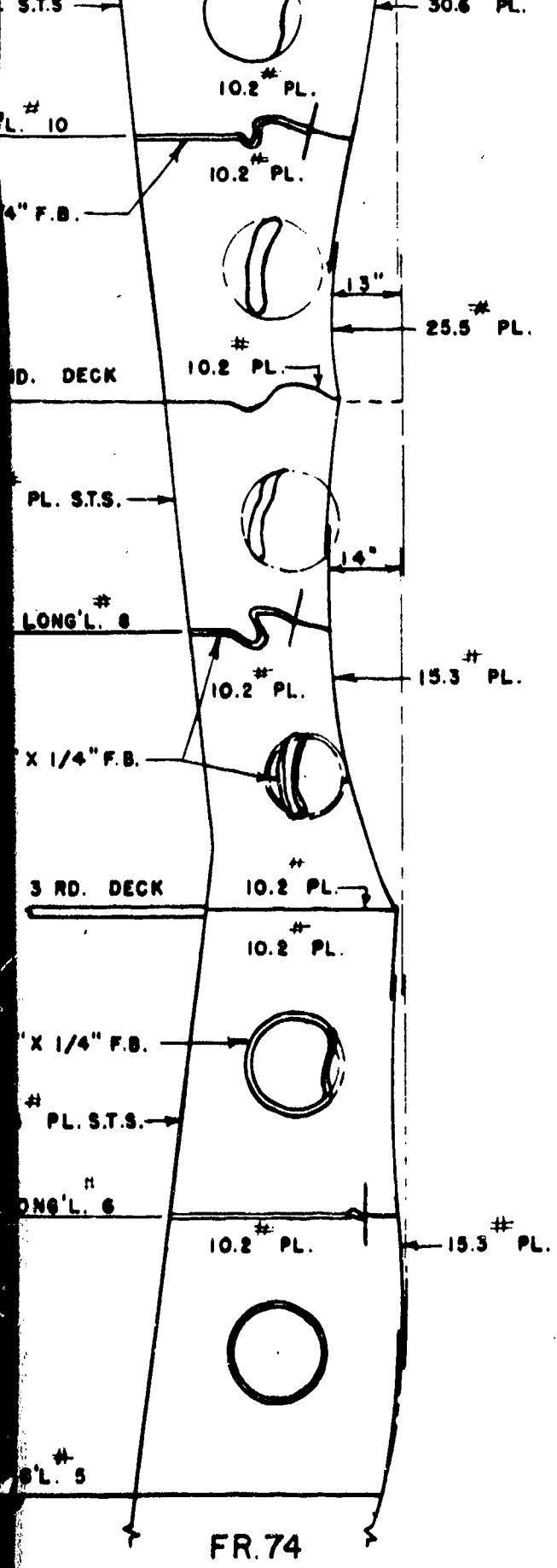

5

1. NO DATA AVAILABLE REGARDING DEFLECTION OF INNER SHELL PLATING.
2. ALL SECTIONS ARE SHOWN PORT SIDE LOOKING AFT.
3. FWD. OF FR. NO. 71 DEFLECTION DIMISHES TO "0" AT FR. 59, FWD. OF FR. 59 LIGHT WASH BOARD EFFECT.

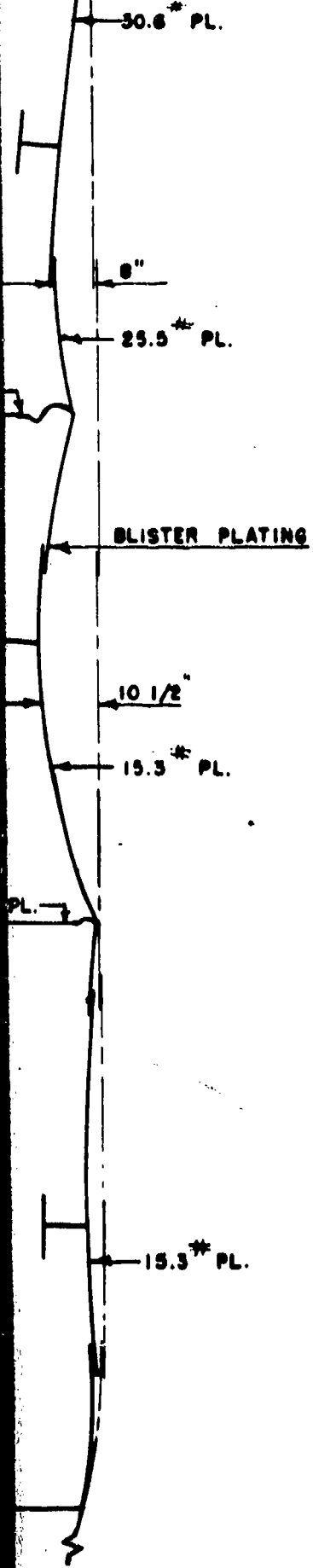

ORIGINAL POSITION OF STRUCTURE _____

SECRET

NAVY DEPT. BUREAU OF SHIPBUILDING

BLISTER DAMAGE

FRS. 71-89, PORT SIDE

TEST A 6

U.S.S. INDEPENDENCE CVL

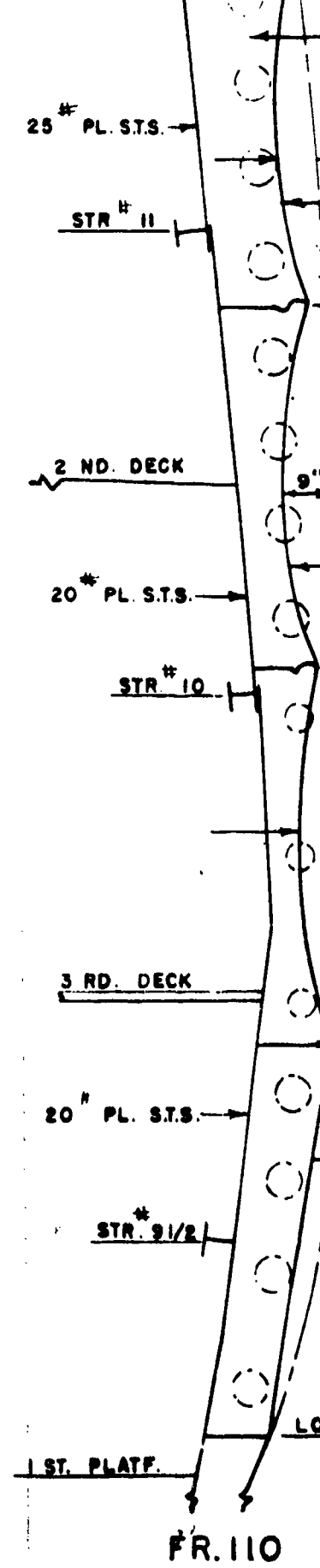
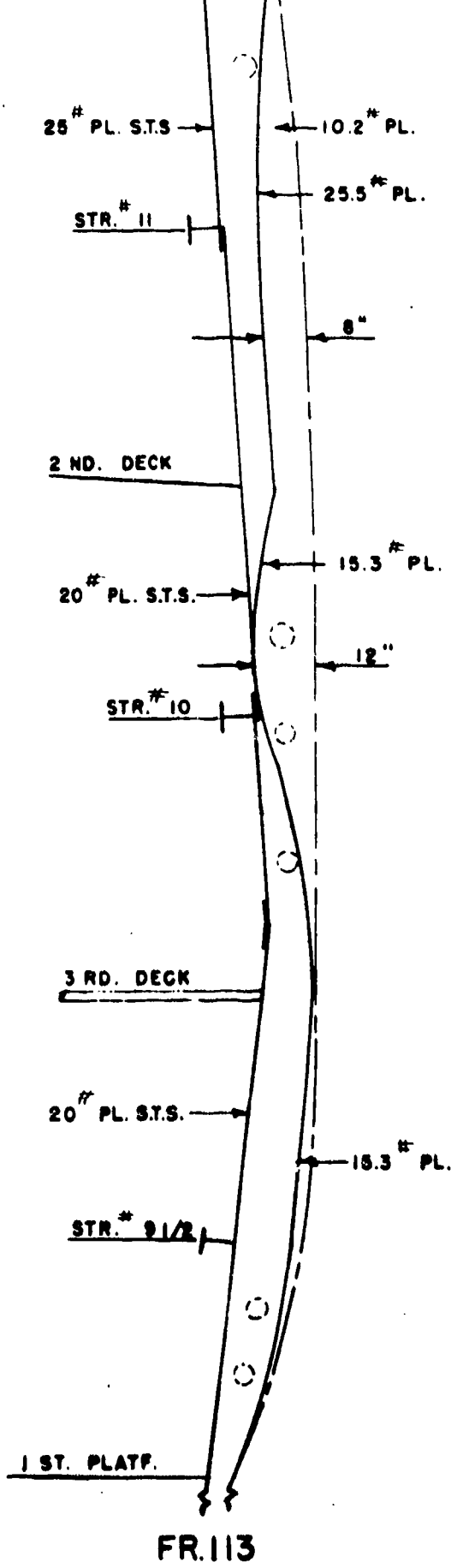

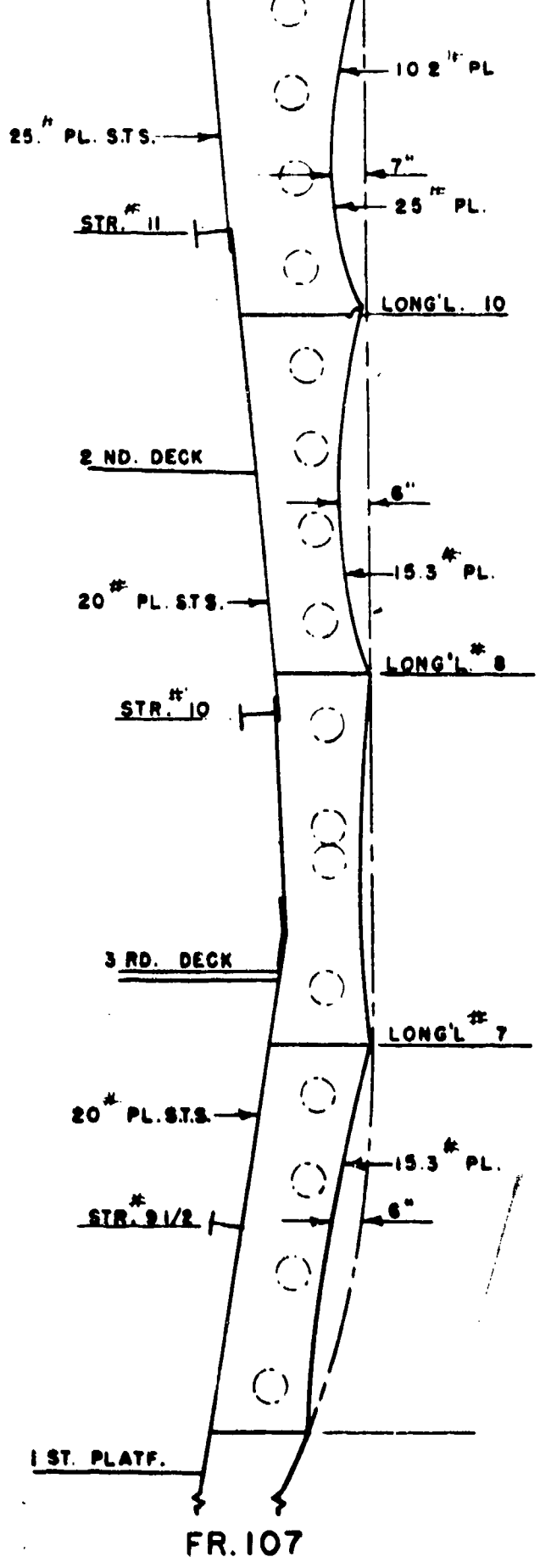
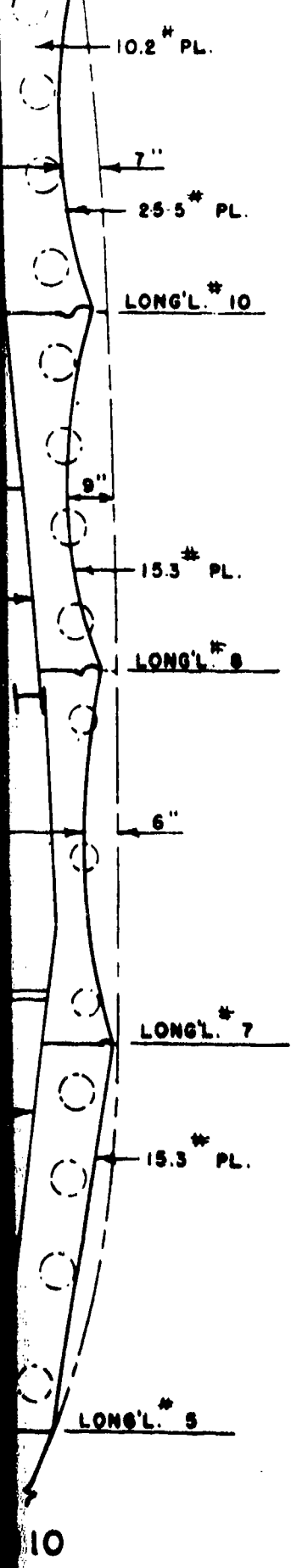

2

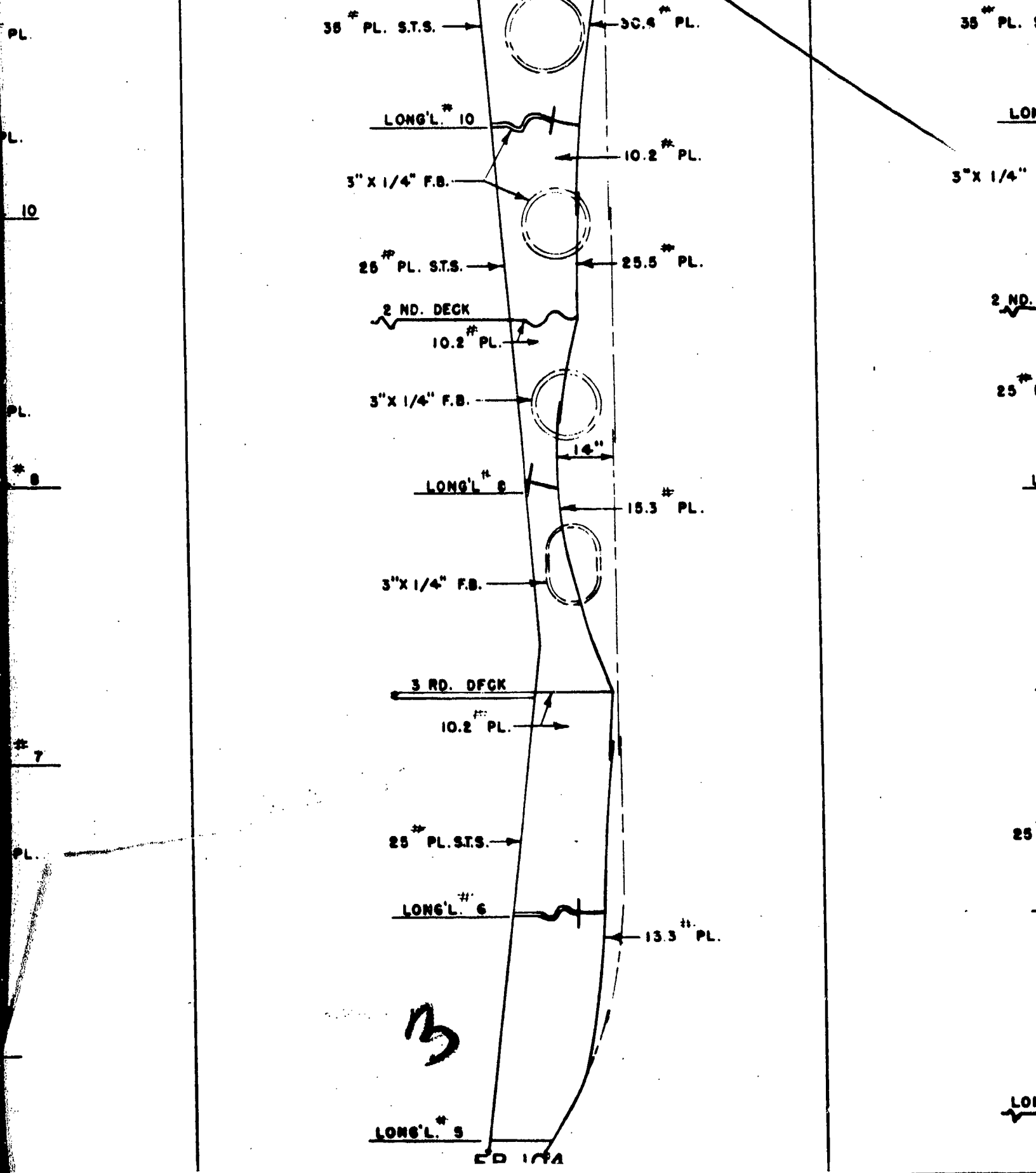

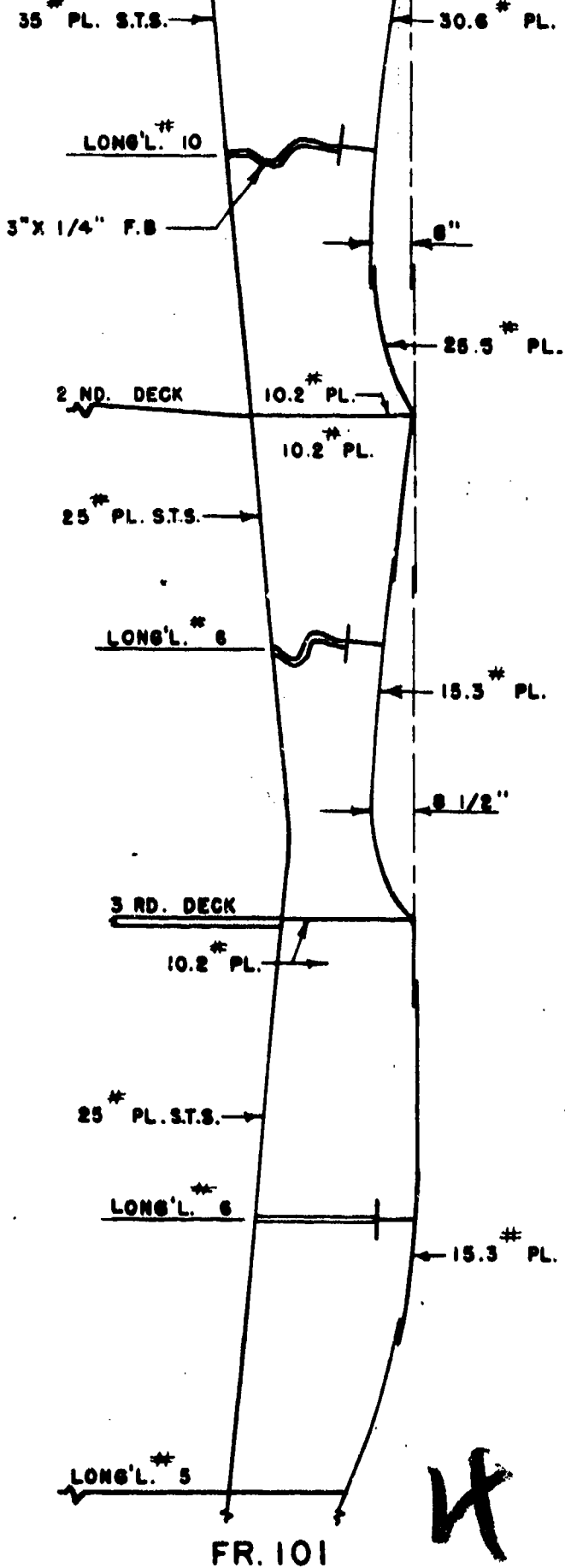

H

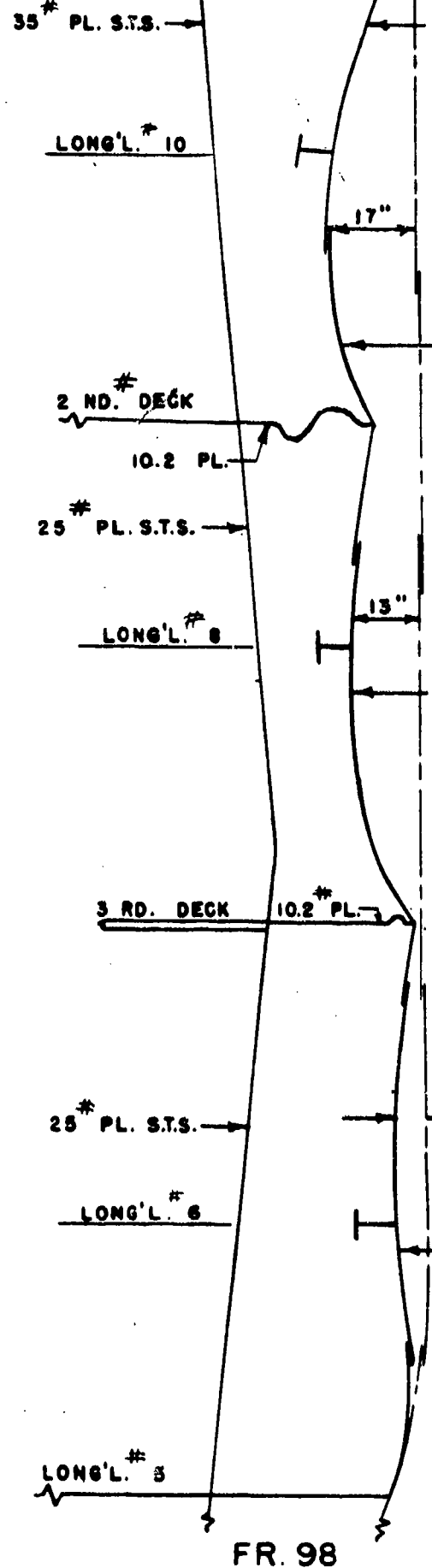

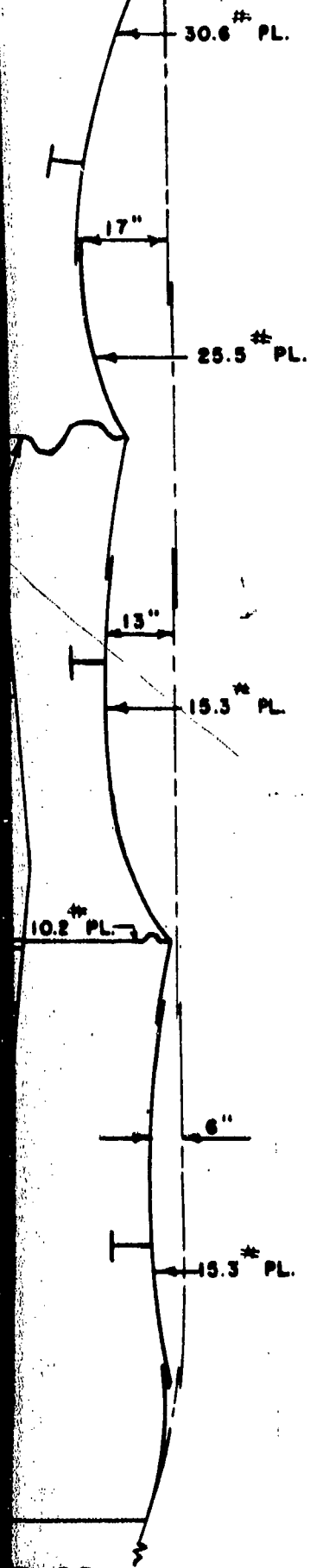

R. 98

5

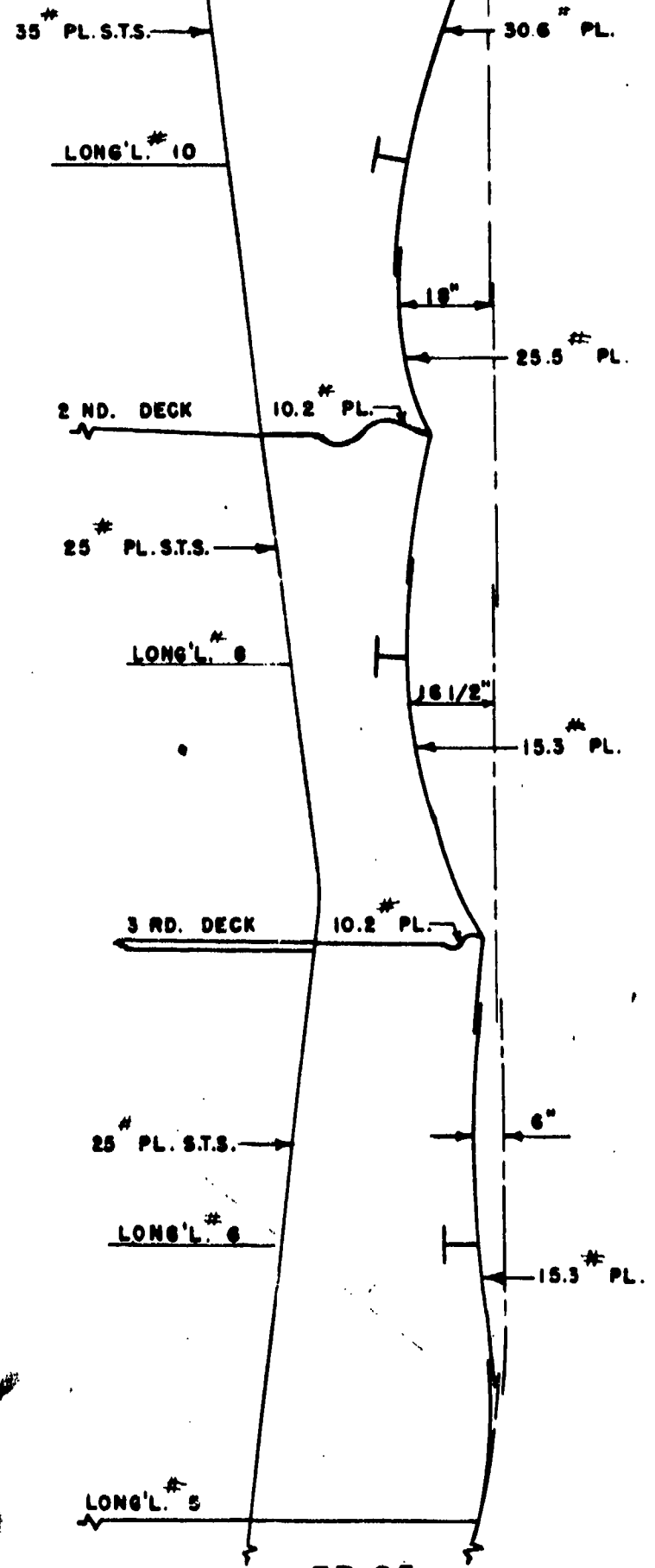

FR. 95

35"

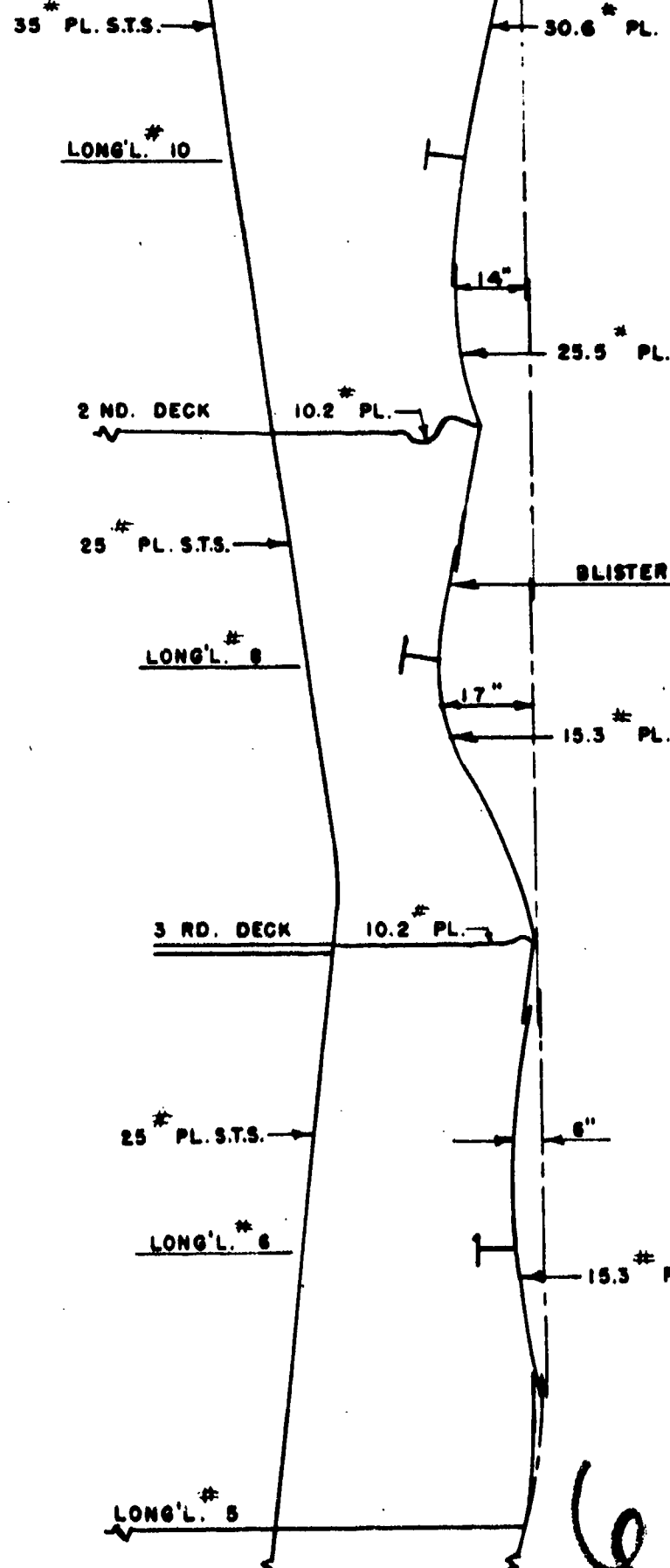
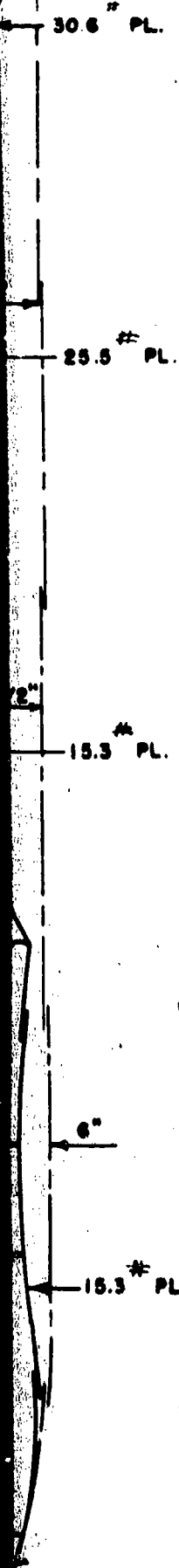

FR. 92

6

NOTES

1. NO DATA AVAILABLE REGARDING DEFLECTION OF INNER SHELL PLATING.
2. ALL SECTIONS ARE SHOWN PORT SIDE LOOKING AFT.

ORIGINAL POSITION OF STRUCTURE _____

SECRET

NAVY DEPT.

BUREAU OF SH

BLISTER DAMAGE

FRS. 92-113, PORT SIDE

TEST A

7

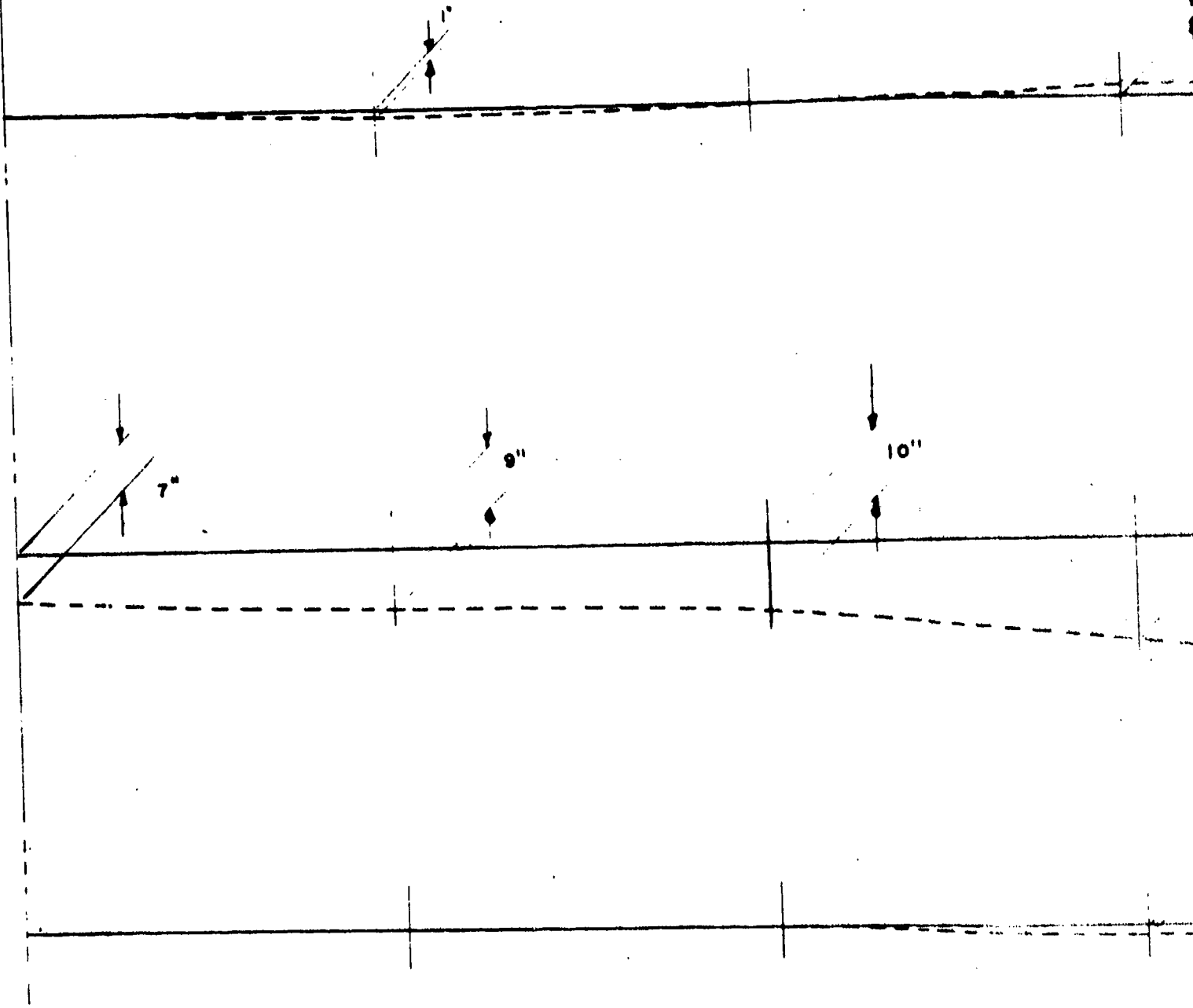

FRAME 113



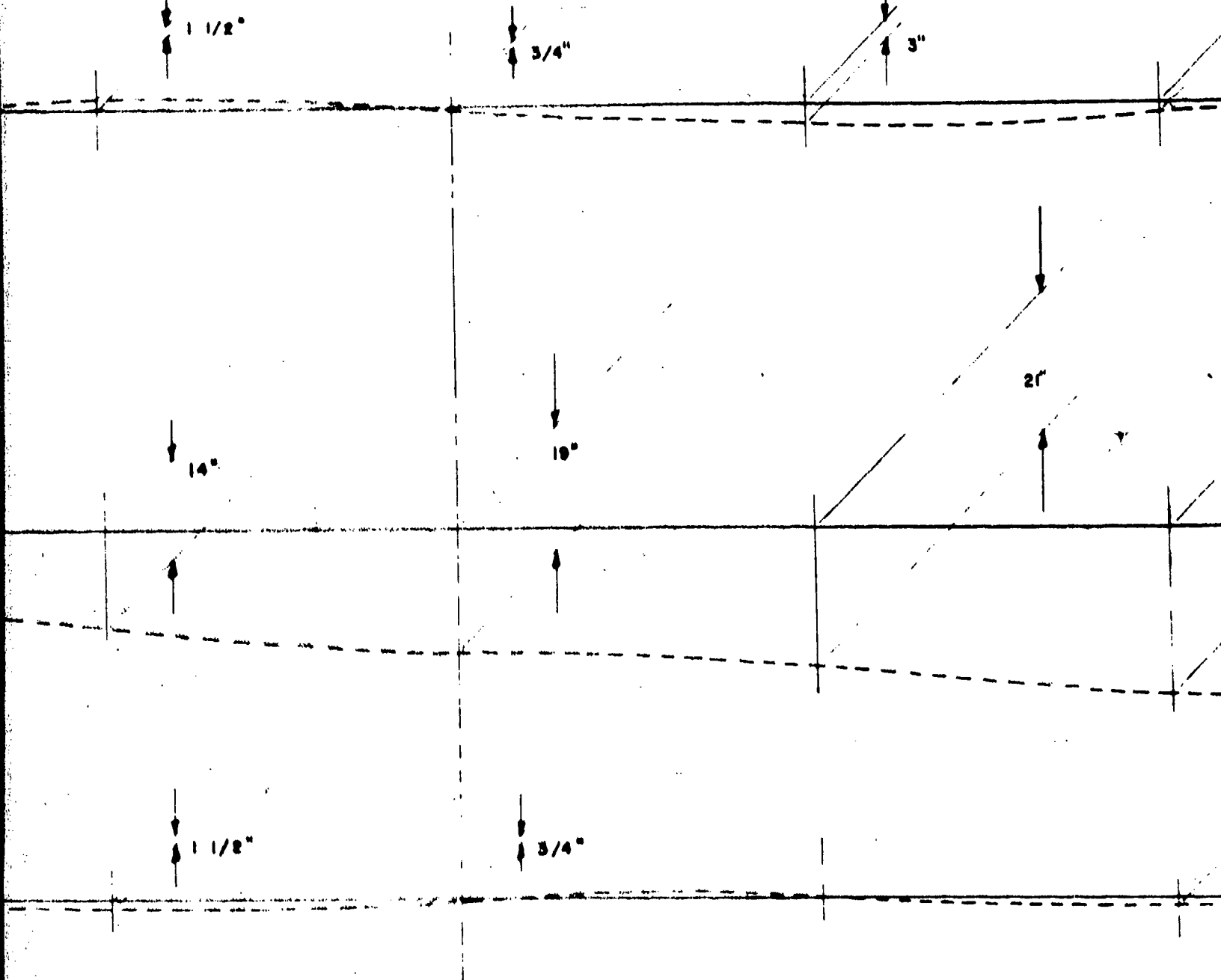

FRAME 101

2

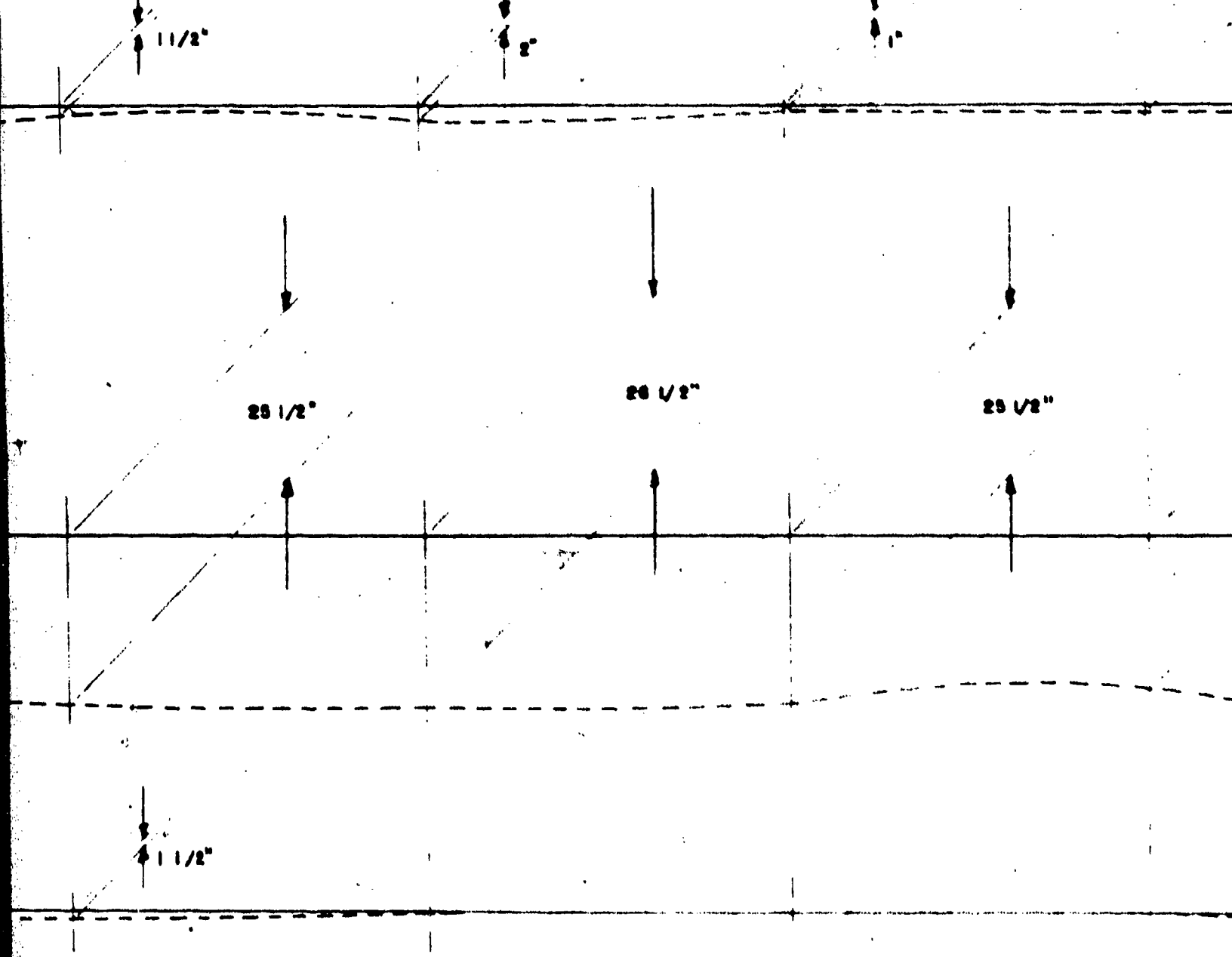

FRAME 86

SHEER LINES - PR

3

1" 1 1/2" 3"

PORT DECK EDGE SHEER (3 FEET INBOARD)

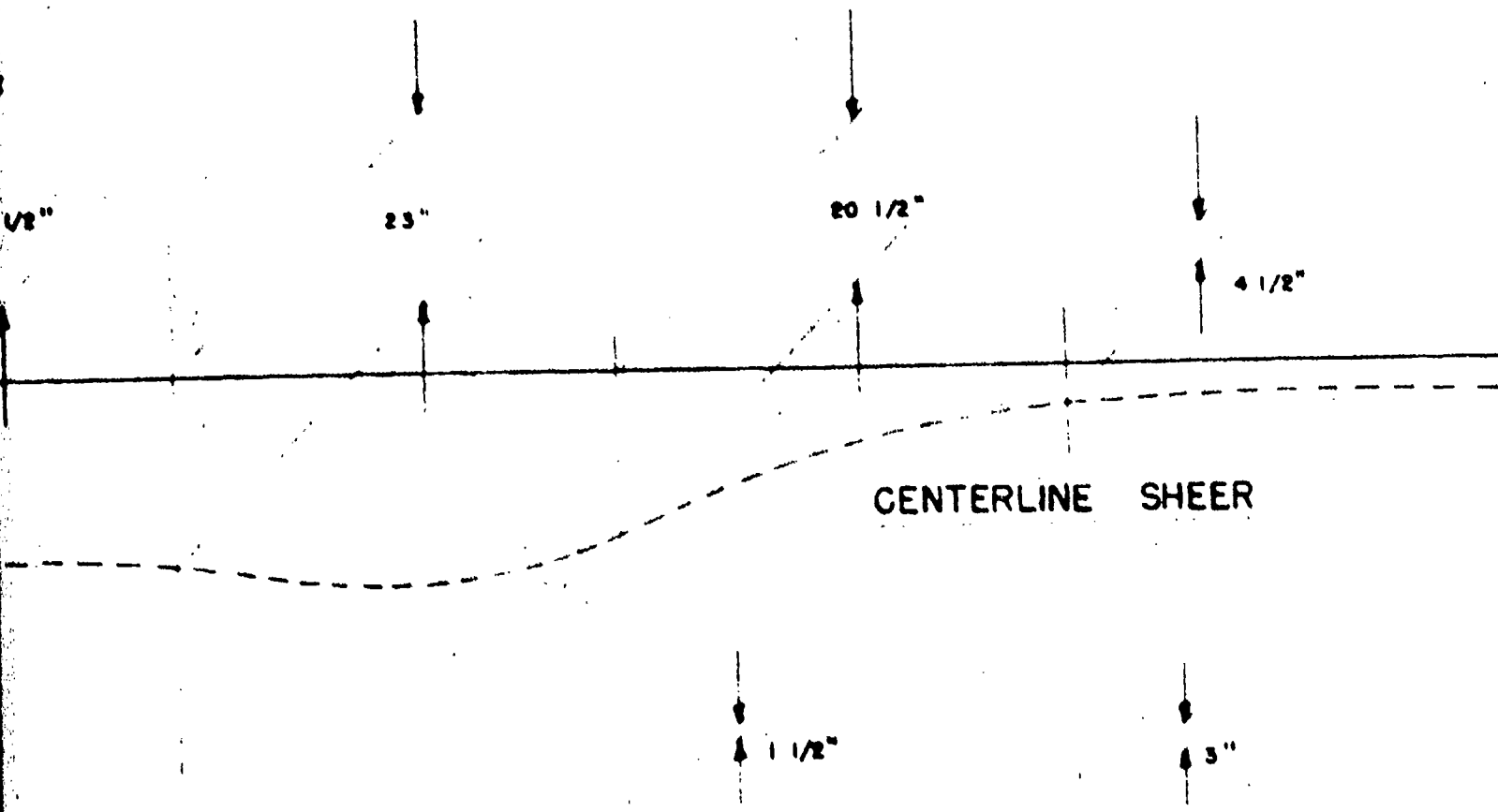

CENTERLINE SHEER

STBD. DECK EDGE SHEER (3 FEET INBOARD)

FRAME 86

LINES - PROFILE

4

ARD)

1/2"

ARD)

FRAME 71

5

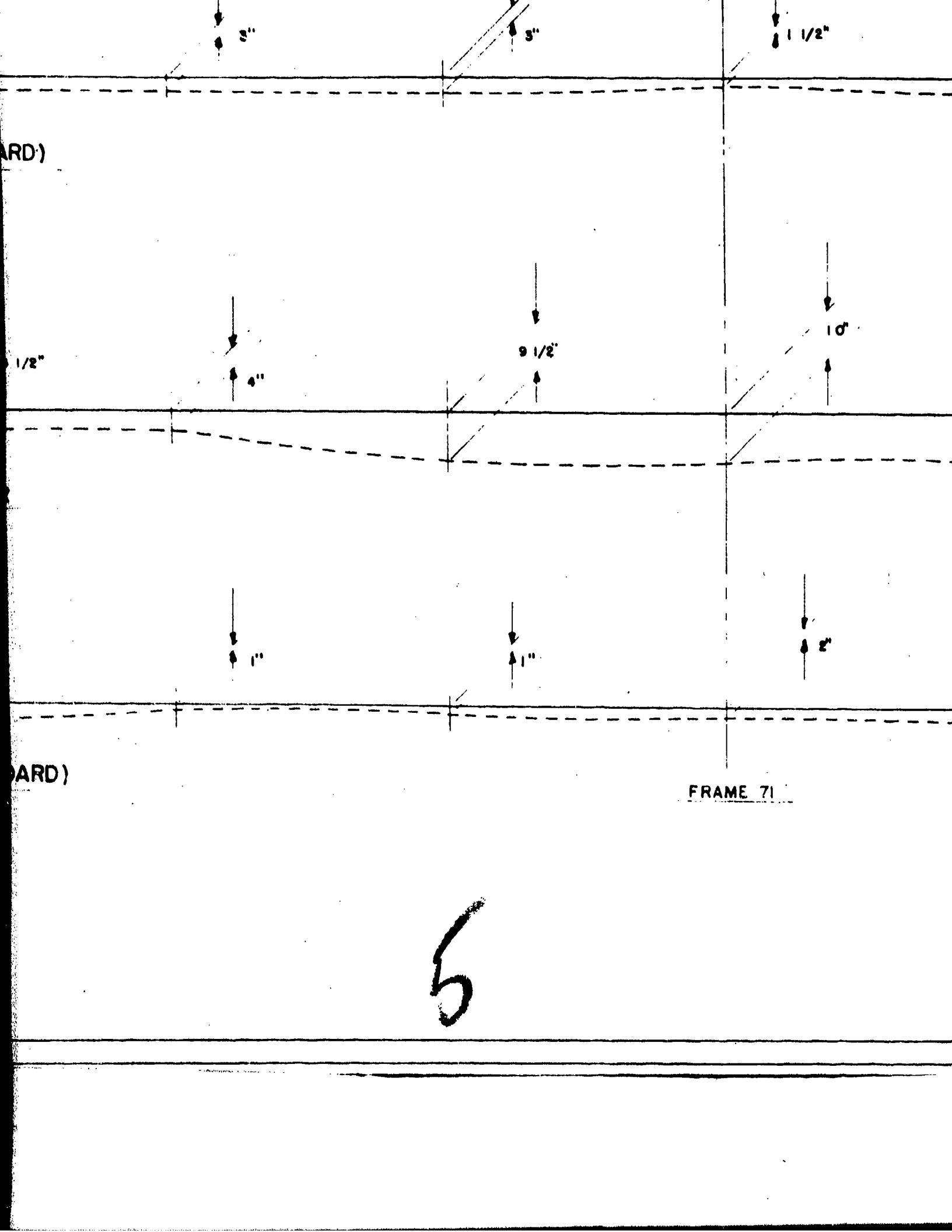

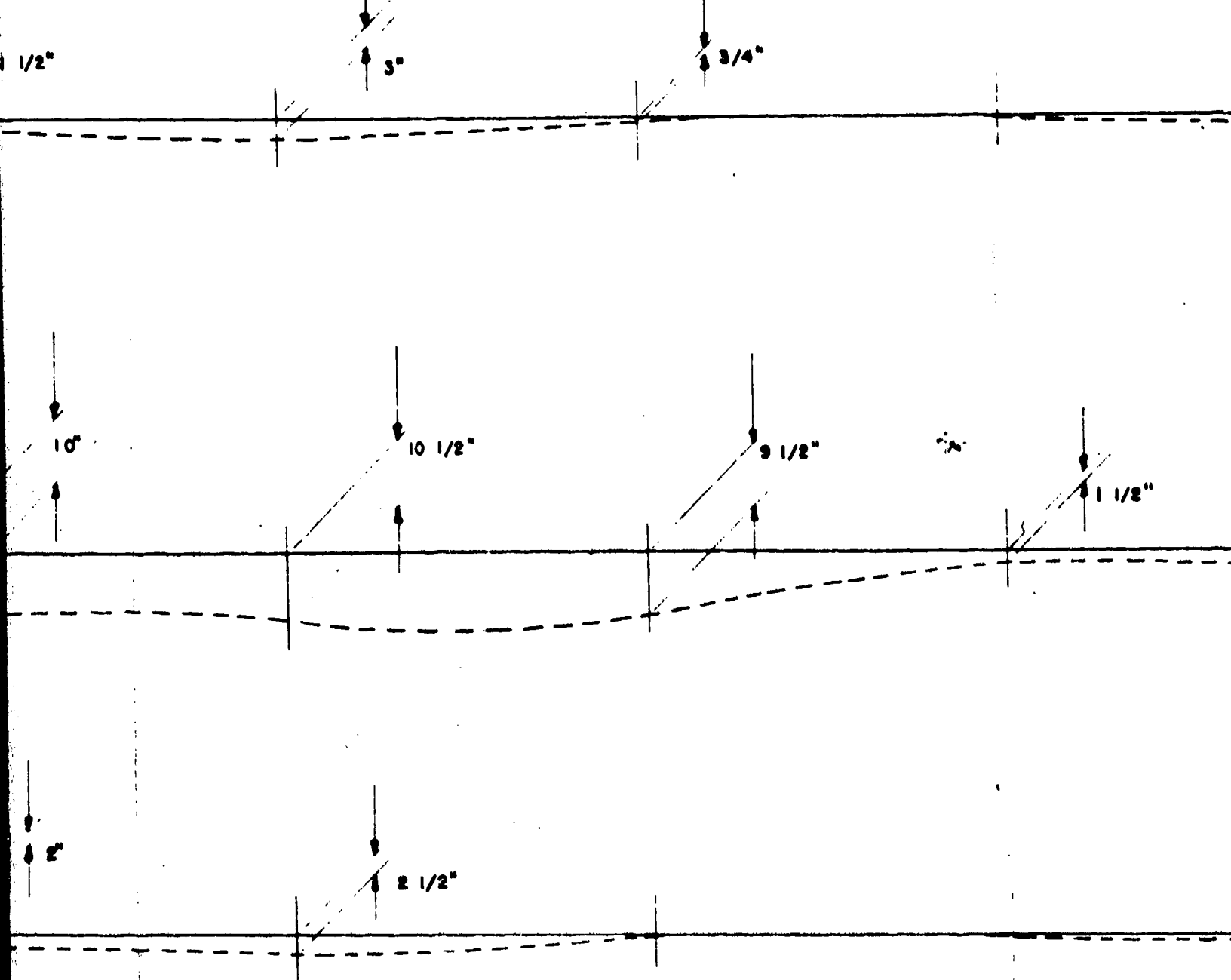

_____ BEFORE
 - - - - - AFTER

6

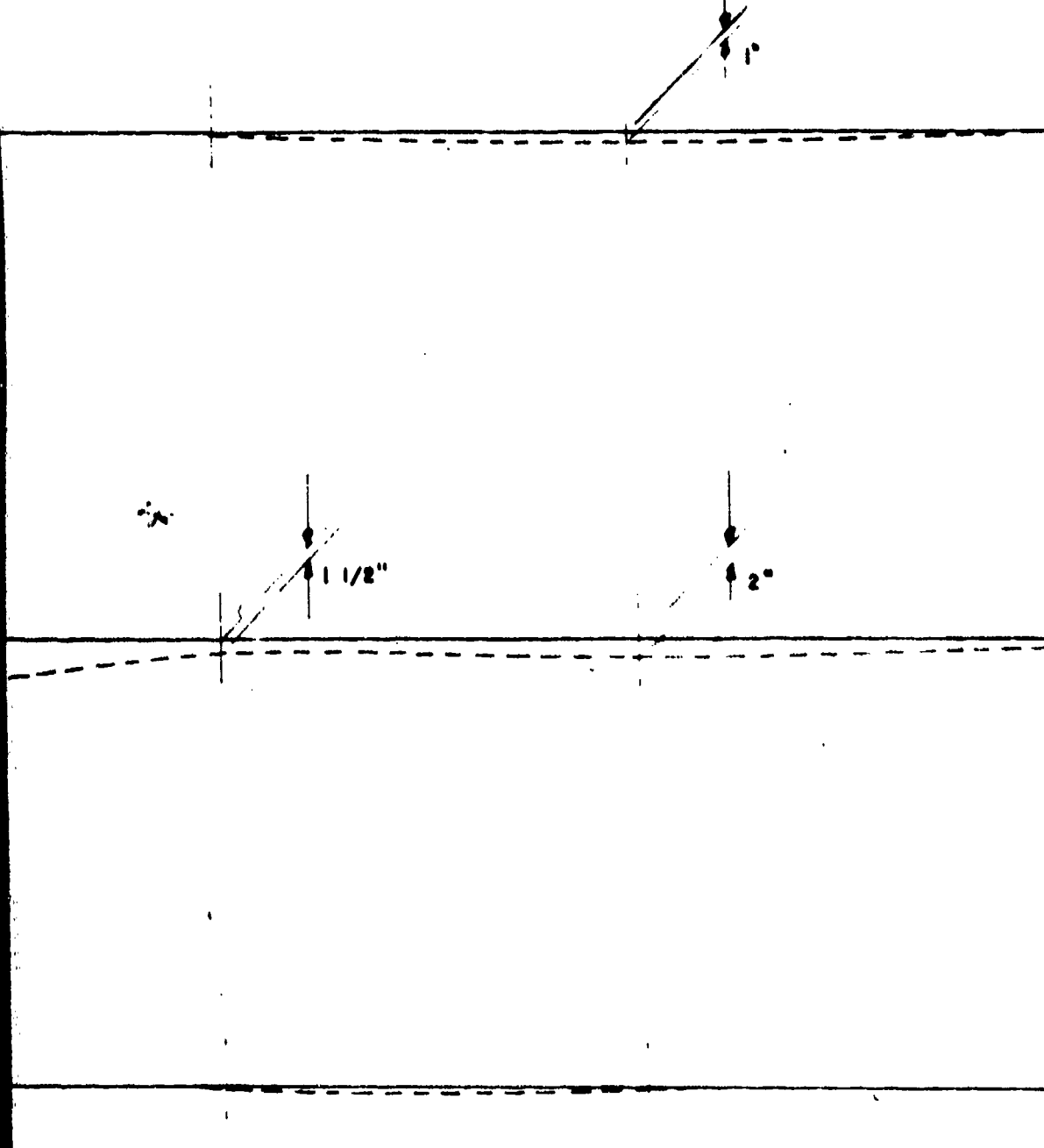

FRAME 56

_____ BEFORE TEST
 - - - - - AFTER TEST

7

SECRET
 NAVY DEPT. BUREAU O
 DECK SURVEY
 TEST A
 U.S. INDEPENDENCE CV
 PLATE NO. 41

STBD.

DECK EDGE

DECK EDGE

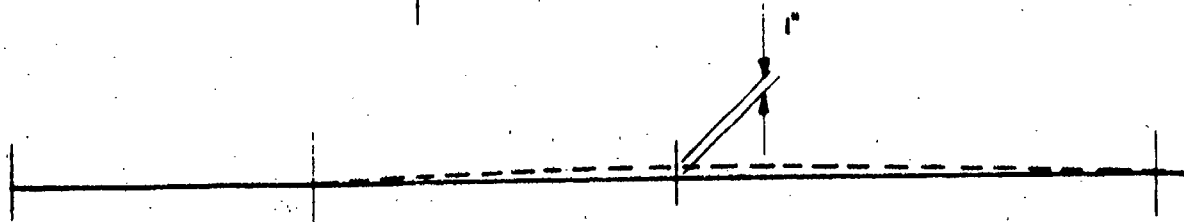
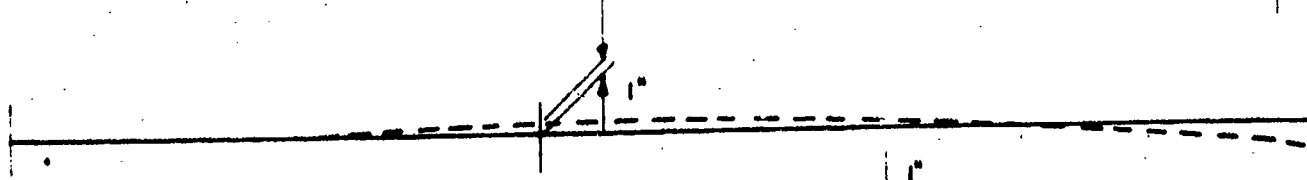
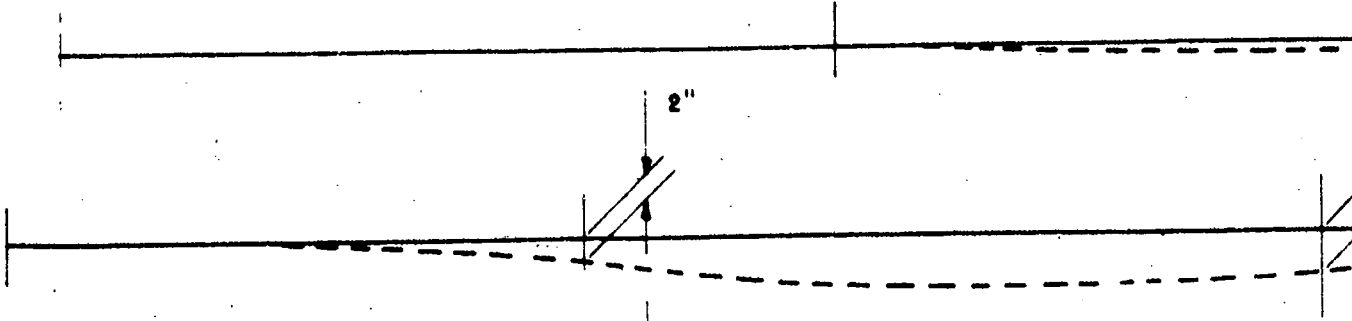
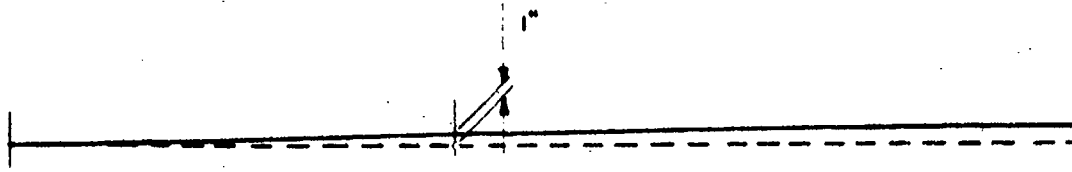

STBD.

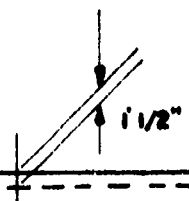

FRAME

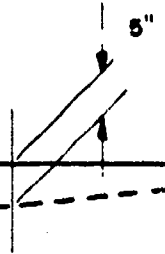

FRAME

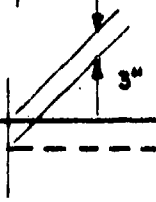
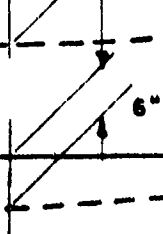
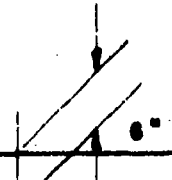
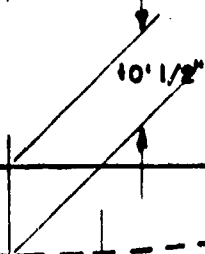

2

FRAME 56

FRAME 71

FRAME 86

FRAME 101

FRAME 113

TRANSVERSE SECTIONS

LOOKING AFT.

3

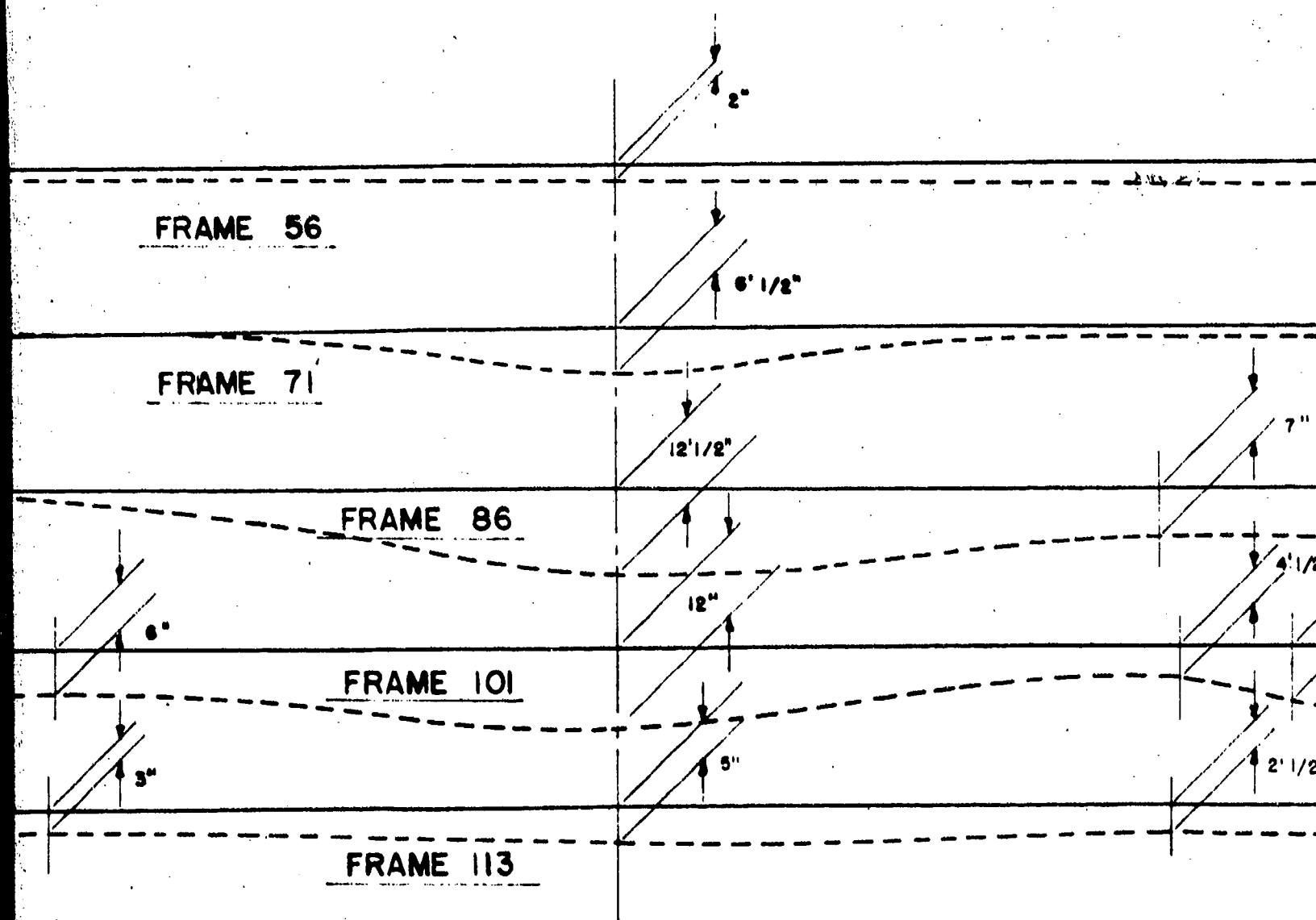

PORT

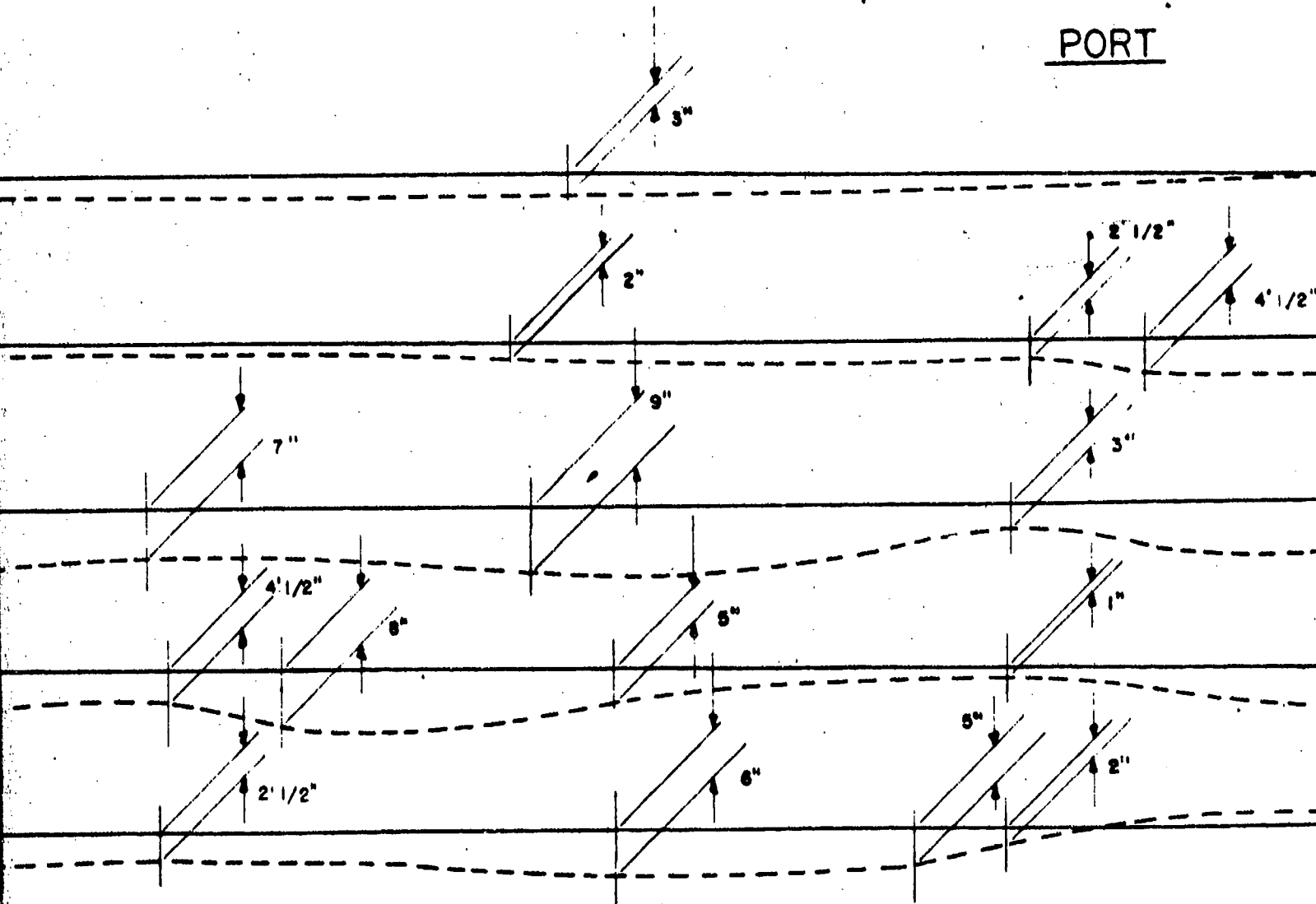

K

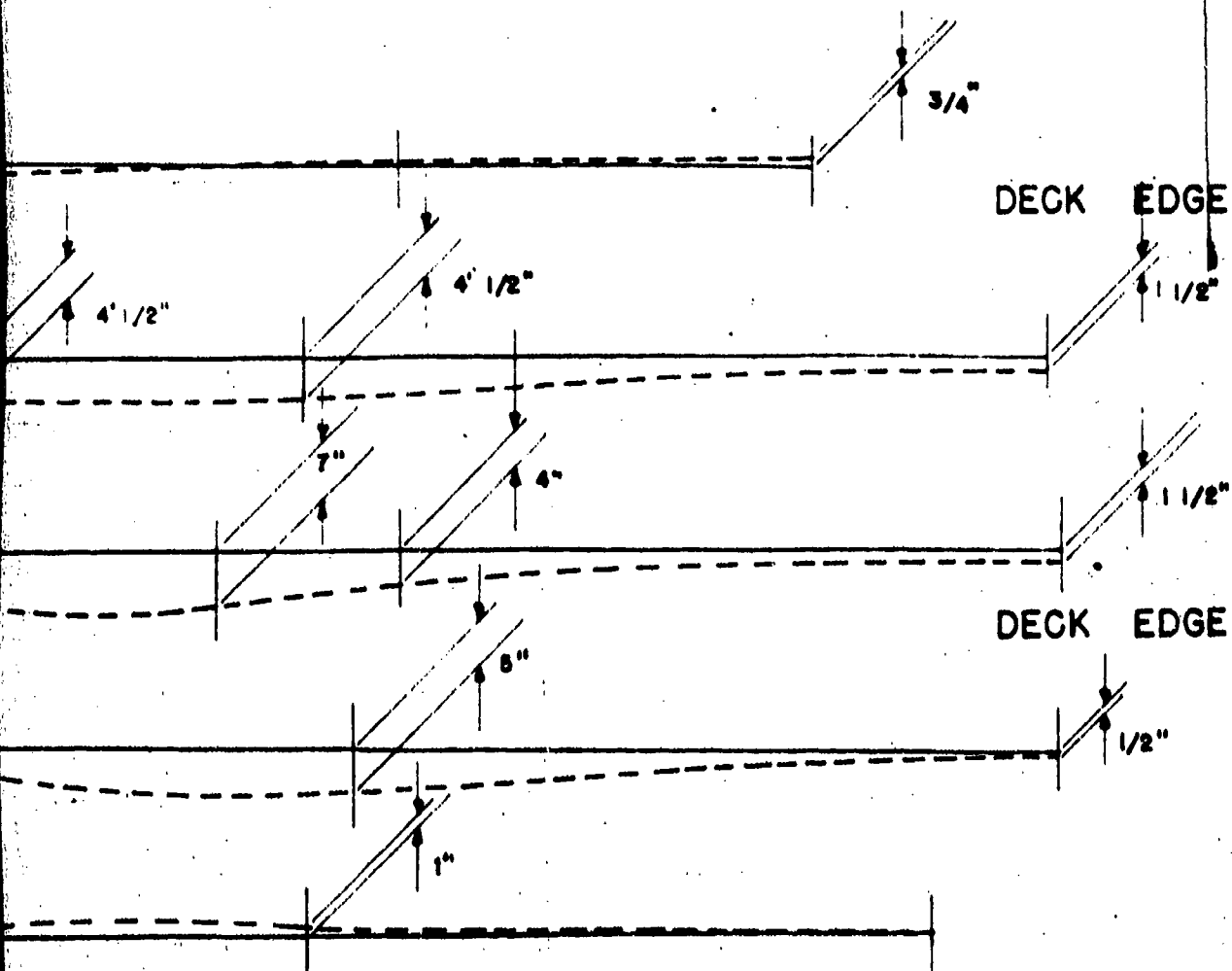

_____ BEFORE TEST
 - - - - - AFTER TEST

5

SECRET

NAVY DEPT BUREAU

DECK SURVEY

TEST A

U.S. INDEPENDENCE

PLATE NO. 42

DECK DEFLECTION GAGES

SHIP U.S.S. INDEPENDENCE (CVL-22)

TEST A

FR. NO.	LOCATION		MAXIMUM COMP.	MAXIMUM EXP.	PERMANENT		SET EXP. / COMP.	REMARKS
	DECK	DIST. OFF ϵ			DISTANCE	DISTANCE		
42	03 Deck	Centerline	0-0-7/8	0-0-0	0-0-5/8	Comp.		Data taken from same plate pipe after test completed to USS INDEPENDENCE CVL-22
60	2nd	Centerline	0-9-5/8	0-0-1/4	None	None		
63	2nd	Port 16'-0"	0-1-3/4	0-0-3/16	0-0-15/16	Comp.		
63	Uptakes	Centerline	None	0-0-1/6	0-0-1/6	Exp.		
63	2nd	STBD 16'-0"	None	0-0-3/8	0-0-3/16	Exp.		
69	Uptakes	Centerline	None	None	None	None		
116	2nd	Centerline	0-1-1/16	0-0-3/16	0-1-0	Comp.		
120	2nd	PORT 17'-0"	0-7-11/16	None	0-5-1/2	Comp		
121	2nd	Centerline	0-2-13/16	0-0-1/8	0-2-3/16	Comp		
120	2nd	STBD 16'-7"	0-5-3/8	0-0-7/16	0-4-1/4	Comp		

SECRET

U. S. S. INDEPENDENCE (CVL-22)

PLATE No. 43
PAGE 2450 F 280

DECK DEFLECTION GAGES

TEST A

SHIP USS INDEPENDENCE (CVL22)

FR. NO.	LOCATION		MAXIMUM COMP.	MAXIMUM EXP.	PERMANENT DISTANCE		SET EXP./COMP.	REMARKS
	DECK	DIST. OFF &			DISTANCE	DISTANCE		
124	2nd	Centerline	0-1-7/8	0-0-3/16	0-0-13/16	Comp	None	None
131	Photo Lab	"	None	None	None	None	None	None
	2nd deck							

SECRET

U.S.S. INDEPENDENCE (CVL 22)

PLATE No. 44
PAGE 2460 F 280

10386

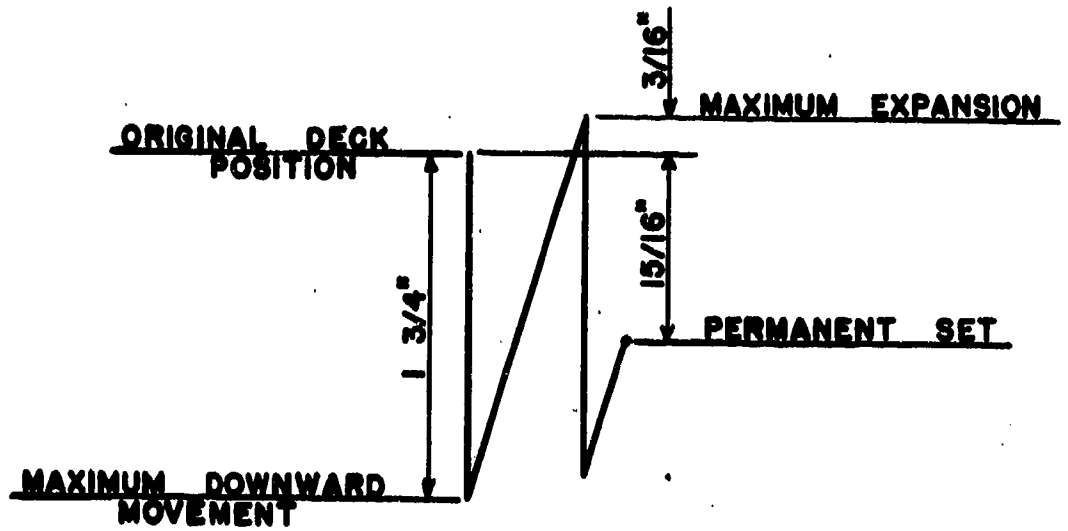

ALL MOVEMENTS VERTICAL,
LINES SLANTED FOR CLARITY.

U.S.S. INDEPENDENCE, TEST ABLE, PLOT OF MAIN DECK
MOVEMENT. SCRATCH GAGE LOCATION, 2ND. DECK
FRAME 63 PORT 16'-0" OFF CENTER LINE.

SECRET

U.S.S. INDEPENDENCE OVL 22

PLATE NO. 45

PAGE 247 OF 280

10386

POSITION

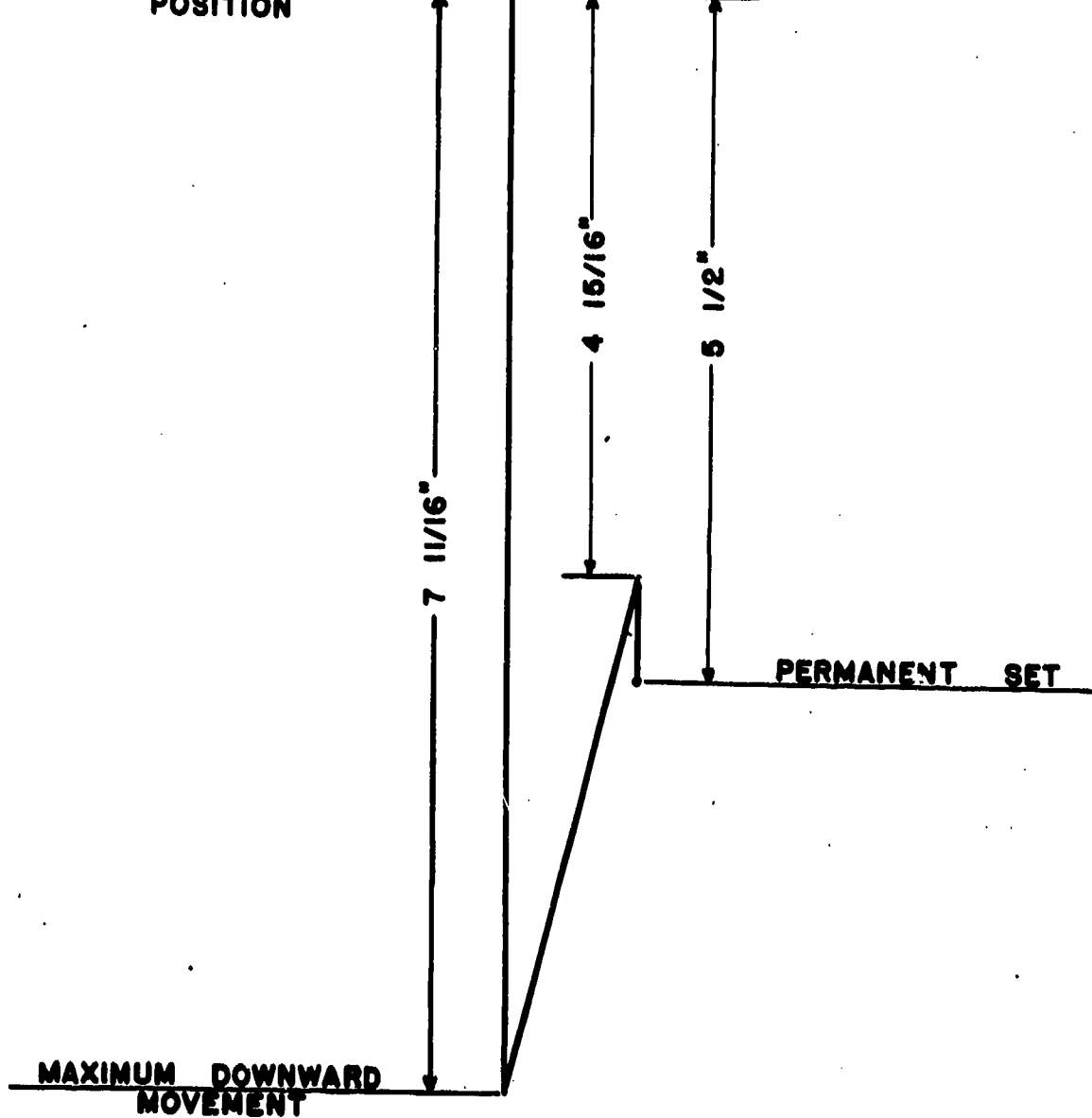

ALL MOVEMENTS VERTICAL,
LINES SLANTED FOR CLARITY.

U.S.S. INDEPENDENCE, TEST ABLE, PLOT OF MAIN DECK
MOVEMENT. SCRATCH GAGE LOCATION, 2 ND. DECK'
FRAME 120 PORT 17'-0" OFF CENTER LINE.

SECRET

U.S.S. INDEPENDENCE CVL 22

PLATE NO. 46

PAGE 248 OF 280

10386

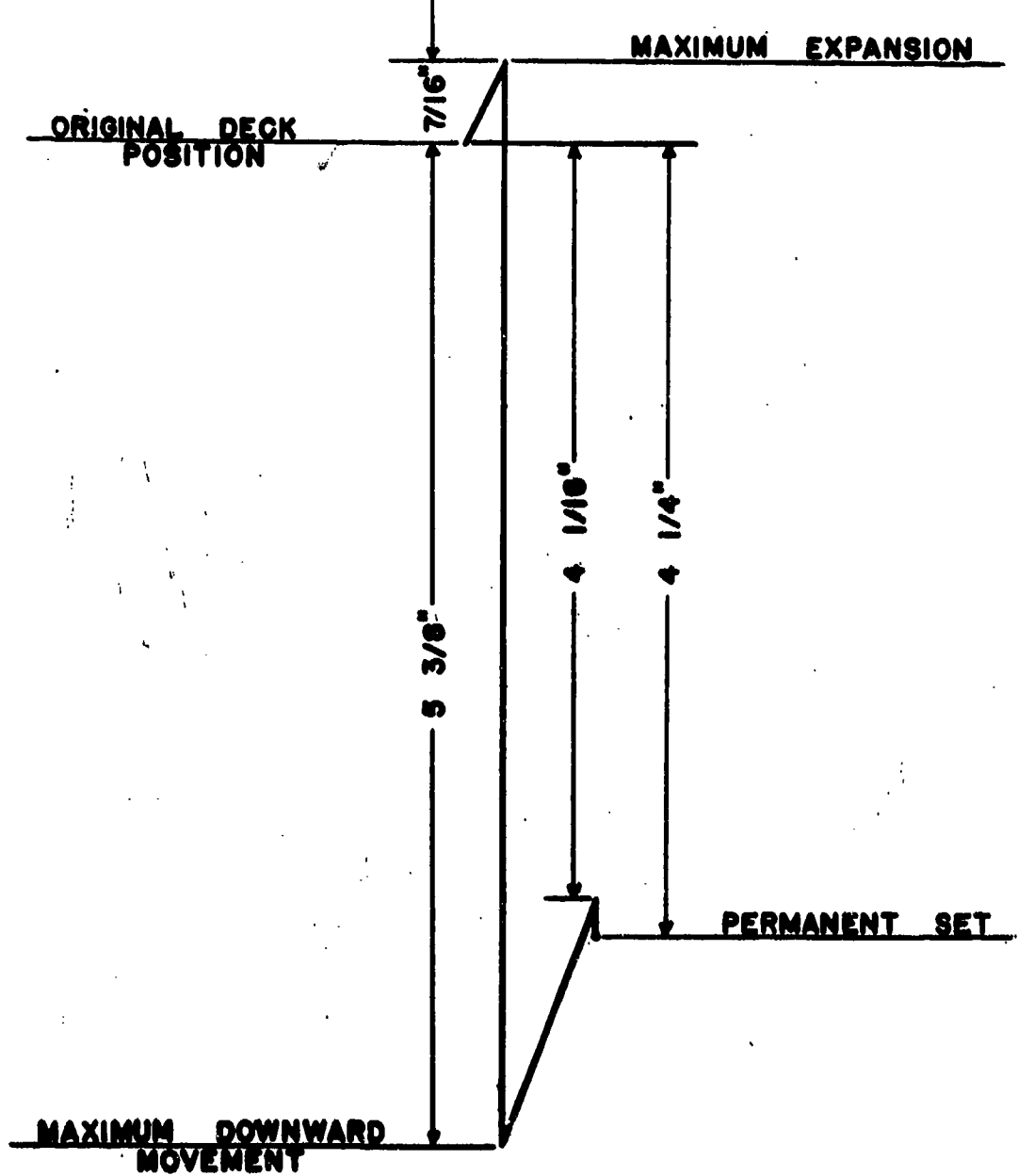

ALL MOVEMENTS VERTICAL,
 LINES SLANTED FOR CLARITY.

U.S.S. INDEPENDENCE, TEST ABLE, PLOT OF MAIN DECK
 MOVEMENT. SCRATCH GAGE LOCATION, 2 ND. DECK
 FRAME 120 STBD. 16'-7" OFF CENTER LINE.

SECRET

U.S.S. INDEPENDENCE OVL 22

PLATE NO. 47

PAGE 2490 F 280

10386

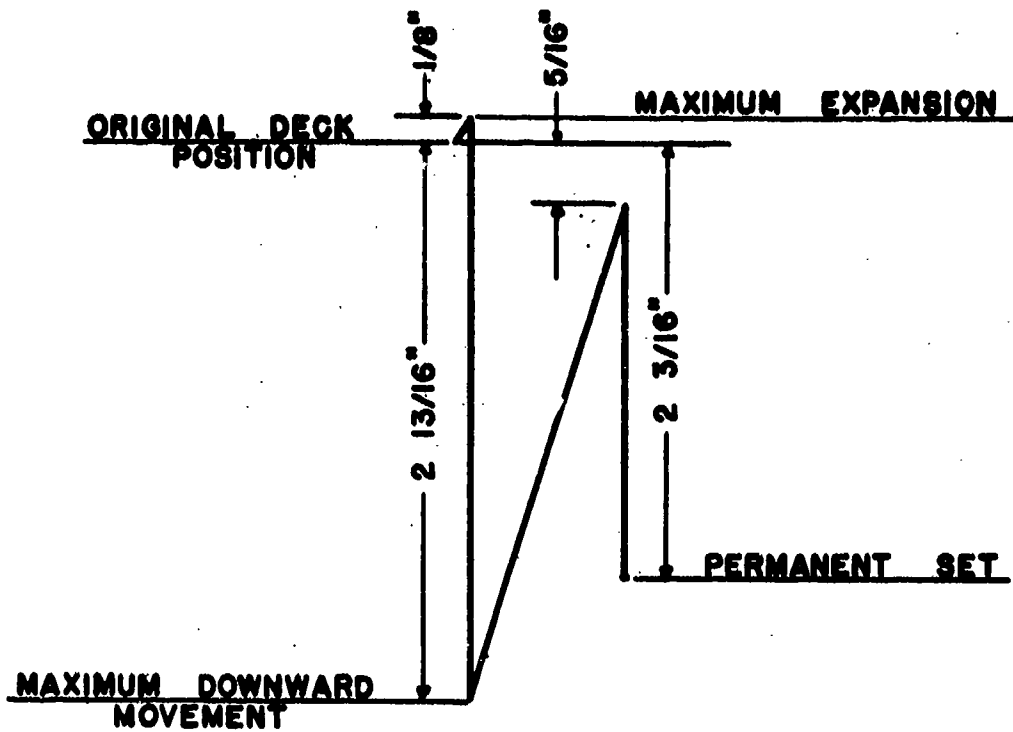

ALL MOVEMENTS VERTICAL,
 LINES SLANTED FOR CLARITY.

U.S.S. INDEPENDENCE, TEST ABLE, PLOT OF MAIN DECK
 MOVEMENT. SCRATCH GAGE LOCATION, 2 ND. DECK
 FRAME 121 CENTER LINE.

SECRET

U.S.S. INDEPENDENCE CVL 22

PLATE NO. 48
 PAGE 250 OF 280

10 386

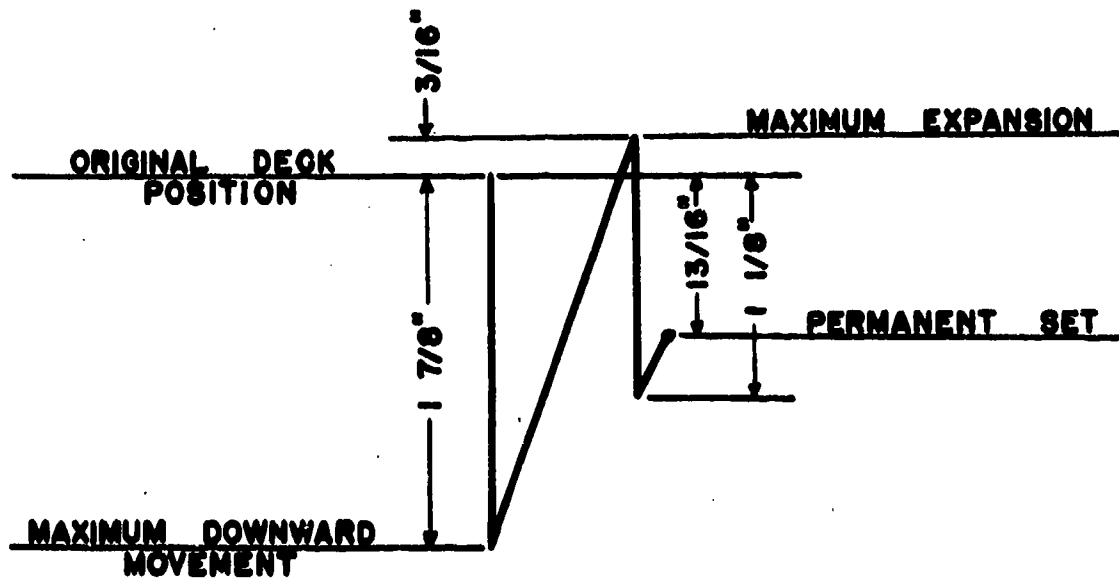

ALL MOVEMENTS VERTICAL,
LINES SLANTED FOR CLARITY.

U.S.S. INDEPENDENCE, TEST ABLE, PLOT OF MAIN DECK
MOVEMENT. SCRATCH GAGE LOCATION, 2ND. DECK
FRAME 124 CENTER LINE.

SECRET

U.S.S. INDEPENDENCE OVL 22

PLATE NO. 49
PAGE 251 OF 280

10 386

APPENDIX

COMMANDING OFFICERS REPORT

TEST ABLE

SECRET

USS INDEPENDENCE (CVL22)

Page 252 of 280 Pages

COMMANDING OFFICERS REPORT

SECTION I

The U.S.S. INDEPENDENCE is a "light" carrier, built in 1942, and commissioned on 14 January 1943. The ship is built from the hull started for the CL U.S.S. AMSTERDAM, and is CVL Number 22. The position in the target array was directly astern of the NAGATO. The distribution of that section of the Operation Order containing the Target Array did not include this vessel and therefore the location given on that sheet is not known.

The material condition of the ship was good, particularly the watertight integrity. Complete tests on watertight closures were made just before leaving San Pedro in May 1946. All machinery was in working order although some parts, particularly the boilers, showed the effects of long and hard use, with no Navy Yard overhaul since July 1944. Catapults, elevators, arresting gear, and other special equipment were in very good condition.

The special equipment on board for the test included the Signal Corps radar and radio sets, Air Corps tank trucks and trailers, deck exhibits of airplane structural materials, etc. This material had no effect one way or the other on the ability of the ship to resist damage. The ship was loaded with gasoline, bombs, ammunition, fuel and aircraft, but this was not special equipment as it is normal for a carrier to carry all these.

SECRET

USS INDEPENDENCE CVL (22)

Page 253 of 280 Pages

PART A - GENERAL SUMMARY

I. Condition of Ship After Test Able.

(a) The fourth day after Able Day, which was the first day the crew of the INDEPENDENCE was allowed to board, the draft was substantially the same as before the test. The draft was twenty three feet for and aft. There was a starboard list of four degrees. There was no flooding except in the starboard shaft alley which is full. The cause of this flooding was a slow leak through the packing.

The principal cause of the list is the very considerable loss of weight on the port side (flight deck, catwalks, gunbuckets, side plating) plus a considerable shift of weight to the starboard side (port plating of hangar deck, airplanes, test material, interior furniture and hangar deck machinery).

(b) The pipe frame mast above the bridge level is gone. The after port overhanging corner of the flight deck to the hull line is gone. The port quarter above the 3d deck is blown in about fifteen feet. Most of the light side plating on the port side in the way of the hangar deck moved to the starboard side of the hangar deck. The hangar deck expanded upward, cracking all of the overhead crossship "I" beams in their centers and all of the "I" beam supports in the hangar deck, either at the elbows at the top or at the bottom. Between the elevators the flight deck resembles a house roof. The side supports which broke beams free at the bottom maintain the shape of the hangar deck (they are welded to the "I" beams at the top) and those that broke at the top (through the elbows) maintain it in position. Otherwise the hangar would have collapsed between expansion joints. Both elevators disappeared.

There is no damage to the hull below the water and none above the water except at the port quarter.

SECRET

USS INDEPENDENCE CVL (22)

... blocking air intakes. Otherwise nothing is wrong with the steam plant. The diesel plant, originally two generators of 150 KW each, could have operated immediately. The ship control station in the bridge was operable. The ship control station at the port forward corner of the flight deck was operable. When an uptake was cleared the ship could have been controlled from the bridge, as engine telegraph, repeater compasses and rudder control were all operable.

About half the 40mm mounts could have fired. All radars were blown off.

(d) The bomb flash did not have much heating effect on the ship. Paint was not scorched anywhere. The flight deck was not charred. It had an effect on both paint and deck in that there was a noticeable darkening which came on gradually over several days. No exterior fires were set. The two airplanes on the stern apparently were blown off without starting any gasoline fires.

Estimated Casualties:

(1) In daylight, if operating, fifty percent casualties including seventy-five percent of the Air Department.

(2) At night, not operating, twenty-five percent.

II. Forces and Effects.

(a) Heat effect - Nil.

(b) A small fire started in the blown in port quarter. It slowly spread to the torpedo storage and twelve warheads burned causing relatively little damage. The cause of the fire is not determined. With all that metal flying around there would have been enough friction to start lots of fires.

The normal stowage of the warheads was in the magazines and not in the thin walled compartment which was blown in by the initial blast. However, some of them would have been in the hangar

SECRET

USS INDEPENDENCE CVL (22)

Ammunition in ready lockers around the flight deck was not damaged. Bombs and rockets in the magazines were undisturbed. The gasoline in its regular stowage (40,000 gallons divided between two tanks) gave no trouble and the stowage was not damaged.

(c) Shock.

The shock was from port, and from aft. The motor-tank-pump unit of the port catapult jumped to starboard about eight inches, then to port about two, putting the catapult out of line and making it inoperable. The airplane crane jumped up enough to cause the kingpost to leave its bottom bearing. Tall castings on light bases, such as the carburetor of a motor generator set (Signal Corps) and the bridge engine telegraph casting, broke at the bottom. The shock was not exceptional however, since pictures, clocks, battle lanterns, bulletin boards and so on in the forward part of the ship remained in place. The starboard anchor in its hawsepipe jumped enough to break the link connecting the pelican hook to the deck lug. Loss of the anchor was prevented by a wire strap at the end of the 5 fathom shot. The starboard chain was on the bow mooring buoy.

(d) Pressure.

The pressure direction was from port and from aft, the angle with the centerline was about sixty degrees. It generally affected flat areas facing the port and all overhangs on the port side. The port side of the hangar deck was blown in and the deck above went up. Dogged doors and doors generally blew in before the surrounding walls. The two elevators apparently went straight up as there are no marks on the ship from them.

(e) Effects peculiar to the atom bomb.

None noted except light flash and induced radiation which prevented return to the ship for four days. Also there was a strong wind toward the point of explosion after the pressure was gone.

SECRET

USS INDEPENDENCE CVL (22)

(a) Propulsion stopped for two hours (with crew aboard). Ship control out for two hours, because of lack of power.

(b) Accuracy and volume of 40mm fire reduced 50%. Airplanes all demolished.

(c) Watertight integrity and stability only slightly affected.

(d) About fifty percent of the personnel would be explosion casualties. The rest would be hospitalized from the effects from radiation after some days.

(e) The fighting efficiency of the carrier would have been zero. Repairs would have required five or six months.

IV. The sequence of events as reconstructed from damage evidence is as follows:

(a) The Flash - causing practically no heating but much radioactivity. (Four days to cool down).

(b) The shock wave which bounced the crane out of bearing, snapped off the mast structure, broke loose some of the equipment on deck, and damaged the catapults.

(c) Almost with the shock wave the pressure wave which tossed out the elevators, took catwalks and gunbuckets, blew in exposed doors, expanded the hangar deck, and bent the radio masts in over the flight deck.

(d) The deep roll, about 40 degrees, to starboard, which slid the large tank off the flight deck, put the P-47 in the forward elevator pit and the trailer tank in the after elevator pit, put an aircraft engine half way up the starboard side of the hangar, and slid all interior furniture to starboard.

SECRET

USS INDEPENDENCE CVL (22)

Page 257 of 280 Pages

coiled on the starboard catwalk straight across the deck from starboard to port so that they stretched across the remaining debris and the broken deck.

(f) The slow fire which started with the blast and slowly worked through the compartments above the third deck aft of frame 126. Starting at 0900 on 1 July, it reached the torpedoes during the afternoon, burned the tires on the trailer in the after elevator pit about 1700 and burned the flight deck plating all the next day and night. The fire went out sometime during the night of 2 July.

SECRET

USS INDEPENDENCE CVL (22)

Page 258 of 280 Pages

SECTION A - HULL

A. General Description of Hull Damage.

(a) Overall condition of vessel.

- (1) Bridge - useable including ship controls.
- (2) Flight deck and hangar deck with elevators - unuseable, except both decks are safe to walk on.
- (3) Crews quarters about half unusable. Chief's quarters are demolished, officers rooms and messes are usable.
- (4) Galley and mess are usable.
- (5) Shops and storerooms in the stern are demolished.
- (6) The main propulsion plant is intact except for stacks and uptakes. Lights were available except in the hangar and all decks aft of the after elevator above the 3d deck.
- (7) The underwater hull is still watertight.

(b) General areas of hull damage.

- (1) The port side of the hangar is blown in. Every other supporting "I" beam is broken off at the hangar deck level.
- (2) The port quarter is blown in through the skin and various interior bulkheads past the center line.
- (3) The starboard side of the hangar is partly blown out and holed.

SECRET

USS INDEPENDENCE (CVL22)

expanded.

(c) Apparent causes of hull damage in each area.

(1) Port side hangar deck damage was caused by pressure on the outside followed by leverage from the overhead beams when the pressure got inside. The large "I" beam supports were broken free from their bases by pressure on the outside. Those that were broken at the top were broken by leverage from the overhead beams.

(2) The port quarter was blown in by outside pressure.

(3) The starboard side of the hangar deck was damaged mostly by flying plating from the other side and by the airplanes being blown on to and through it. The pressure that got into the hangar was not enough to blow the starboard plating off or to break the supporting beams loose at the bottom. Those beams that are loose at the hangar deck were pulled loose by a tilt from port to starboard. Most of the starboard supporting beams are broken at the top by leverage of the overhead.

(4) The area around the torpedo stowage just aft of the after elevator was damaged by the burning of the twelve warheads on the torpedoes in the stowage.

(d and e) There was no flooding of the hull and little apparent effect on its strength or buoyancy.

B. Superstructure.

(a) Description of damage.

(1) Bridge area. The floor and side plates of the bridge are warped. The doors in the island are all blown in. Electric circuits to the bridge are intact. Damage appears to be all due to blast from the port side. The pipe frame structure supporting the lookout platform, searchlight platforms, yardarm and radar, is gone.

SECRET

USS INDEPENDENCE (CVL22)

bad from outside pressure on all sides. Except where hit by external objects the uptake and stack metal remained approximately in place.

(b) Causes of damage - covered in (a) above.

(c) There was no fire in or outside of the superstructure.

(d) The "island" or bridge structure is a box about six by twenty-four feet by twenty feet high. The bridge is a rectangular platform around this at the fourteen foot level. The box is of 1/2 inch plate with 5 inch "I" beams inside at two feet spacing. The vertical bridge plating, or rail, is 3/8 inch plate; about four feet high all around. The box and bridge took the blast without deformation except at the extra 18 inch over hang on the port side which forms the Air Officers station. The rail at this point bent inward at the top about one foot.

(e) The pipe-frame structure above the bridge with its searchlights, radars, yardarm and masthead must have offered much resistance to the blast. It is gone completely. If it had been strong enough to take the blast it would have been too heavy for the ship. It is recommended that this part of CVL construction be kept about the same so that it will break off cleanly and so not take the bridge with it. The missing structure was based on four inch pipes with 1/4 inch wall thickness.

C. Turrets, Guns and Directors.

(a) Protected mounts.

No comment.

(b) Unprotected mounts.

(1) Of four twin forty millemeter mounts only the starboard forward one is in good condition and operable by hand. The after starboard mount and bucket are in good condition except

SECRET

USS INDEPENDENCE (CVL22)

inoperable.

(2) There are no crew shelters.

(c) Directors. Of the four directors mounted, none are operable. None are missing. In general they have bent and broken sights and broken glasses.

(d) The forty millimeter mounts, directors and buckets will take an atom bomb if it is not too close. No outstanding weakness are apparent. As to shelters, the only effective shelter would have been access to the other side of the ship, and this would not have been effective over the hangar area where the blast went clear through.

D. Torpedo Mounts.

(a) None installed.

E. Weather Deck - Flight Deck.

(a) Forward of the forward elevator the deck is good. This includes the catapult tracks. Between the elevators the deck is humped up like a house roof. This was caused by pressure in the hangar. Aft of the after elevator, the blast took away all of the flight deck which overhung the port quarter. The wood deck of the rest of this area is burned because of burning in the compartments below it.

The forecastle deck is undamaged except for the hand rail which is missing. The fantail deck is intact on the starboard side only.

(b) The flight deck is usable only for walking. The catapult tracks are not damaged.

(c) Condition of equipment and fittings.

(1) The anchoring and mooring, fittings are intact on the forecastle. They are usable only on the starboard side of the fantail.

SECRET

USS INDEPENDENCE (CVL22)

Page 262 of 280 Pages

intact and usable. On the port side they are gone.

(3) The airplane crane appears undamaged but it is not usable because the king post is not in its bearing. This derangement was evidently caused by a whip effect from the shock of the bomb.

(4) The barrier and arresting gear is intact on the flight deck, but the oil shock absorbing gear supported just under the flight deck all fell down to the hangar deck. The catapults are both out of commission.

F. Exterior Hull Above Waterline.

(a) The hull below the main deck is undamaged except:

(1) There is one hole in the port blister at frame 68 between the 2d and 3d decks. This was caused by a heavy object falling.

(2) There are 3 small holes in the port plating near frame 105 between the 2d and 3d decks. There are punctures caused by external objects.

(3) There are large holes with dimensions in feet in the area below the main deck and above the third deck between frames 138 and 149. The bomb explosion blew this area inward.

(4) There are small holes at the 3d deck above the waterline frames 138 to 149, opening into the 1st platform. The cause is the same as in (3) above.

(5) There is a hole about 2 feet by 12 feet on the starboard side just above the main deck at frame 127 to 128. This was caused by the explosion of the torpedoes just inside this place.

(6) There is a wide multiple wrinkle on the starboard side from frame 121 (at the main deck) to frame 126 at the waterline. This was caused by rotation of the stern clockwise under the torque applied by the bomb pressure on the high port side aft of frame 128. A similar wrinkle runs from port to starboard and from for-

SECRET

USS INDEPENDENCE (CVL22)

ward and across the after elevator well. A corresponding wrinkle on the port side is indicated by a couple of waves in the plating but is masked by other damage.

(b) Boat booms and gangways were all carried away by the bomb blast. They were secured for sea.

(c) Sheer strake is intact except at the port quarter where it is collapsed downward from frame 149 to 144 and inward from frame 133 to frame 144.

G. Interior Compartments.

Discussion - Details of the damage to interior structure will be found in Report No. 6 Forms No. 9. This will be general and illustrative. Interior damage was caused by five different effects of exterior forces as follows:

(1) High pressure in the hangar. This crushed down the main deck under the elevators, some places as much as a foot. This is particularly noticeable at frames 49 and 119.

The hangar deck protected the main deck under it and in this large area the crushing mentioned above occurs only in isolated spots. The watertight bulkhead at frame 45 just forward of the forward elevator bulged forward to the limit but did not give way. Its door was not damaged between A-209-IL and A-210-L by the effect noted in (2) below.

(2) High pressure on the port side. This tended to push everything to starboard. The port frames which are continuous from flight deck to the 3d deck leaned to starboard enough to crumple bulkheads near them. This occurs only from frame 57 to 127. The starboard frames were not subjected to this pressure and the humping up of the flight deck prevented this pressure from being transmitted from port to starboard through the flight deck beams. Consequently where a bulkhead has a door near each side, the port door frame is crumpled and the starboard frame is good. Examples of these pairs are watertight doors numbers 2-79-1 and 2-79-2 and 2-91-1 and 2-91-2. This effect is not noticeable below the 2d deck.

SECRET

USS INDEPENDENCE (CVL22)

aft as compared with port side forward. Since the pressure was also applied high up this caused the rolling (clockwise or to starboard) couple to apply more strongly at the stern than amidships where it was relieved somewhat by the blast blowing in through the hangar. This couple twisted the stern clockwise relative to the rest of the ship. The effects of this are diagonal wrinkles in the starboard side as mentioned in F (a) 7 above and diagonal wrinkles in horizontal decks aft of frame 115. Examples are the decks of compartments 202-L and 203-L. Wrinkles in these decks deform the bulkhead at frame 119 but the effect is masked by much greater damage to this bulkhead by pressure down through the elevator well. However damage to door 3-126-3 on the 3d deck is due to this wrinkle in the overhead as is the damage to door 3-126-1.

(4) High interior pressure from the A bomb both for ward and aft of the hangar. Aft of the hangar the blast blew in through the port quarter plating and the high interior pressure, plus fire, scrambled everything about the second deck and aft of compartment C-309-L on the third deck. It is not noted below the 3d deck.

Forward of the hangar the high pressure got in through the forecastle deck door at frame 45 port and the gallery deck door into the ready room at frame 40. This combination blew down all the light interior partitions around the passage ways on both decks at frame 43. The gallery deck bulged down two inches between frames 41 and 45 on the center line.

(5) Expansion due to burning of twelve torpedoes in compartment C-101-B. This was an expansion in all directions which added to and merged with the chaos in this area due to the A bomb. On the second deck it appears as a bulge downward in the overhead aft of frame 126 starboard. On the third deck its effect is lost in the damage caused by the A bomb which pushed the overhead beams down over a greater area.

(e) As noted above there were no exterior or interior fires except in the stern above the main deck and in the after elevator well.

(f) In general piping was injured only at structural damage points. Cables survived intact for the most part except in areas of

SECRET

USS INDEPENDENCE (CVL22)

On the contrary, every ventilation duct examined so far has splits or blow outs in it somewhere.

(g) As an estimate in percentages, watertight subdivision was reduced 100% on the 2d deck, 33% on the 3d deck, 05% on the first platform. Habitability and utility of compartments was reduced 30%.

I. Interior Compartments below Waterline.

(a) The shell plating just above the waterline is holed in the port side into C-407-A, C-415-A, C-416-2A, C-413-A, and C-412-A. The third deck is pushed down about one foot over C-416-2A and C-415-A. These are all store rooms.

(b) A small amount of water got into the above listed compartments and spoiled some provisions. The list of the ship kept the holes above water, otherwise the compartments named would have filled.

Shaft alley C-603-E flooded. It was pumped out and found to be leaking at the packing. Tightening the packing stopped this leak.

Other than mentioned in (a) and (b) above there was no underwater compartment damaged observable. Reduction of habitability and useability is estimated at 05%.

J. Underwater Hull.

Interior inspection reveals no underwater damage. There should be some effect of the rotation of the stern mentioned under Item F above but it has not yet been discovered if present.

K. Tanks.

No comment.

L. Flooding.

No comment.

SECRET

USS INDEPENDENCE (CVL22)

(a) All ventilation was put out of order, generally by opening of ducts or their being carried away by moving objects.

(b and c) The ventilation system did not carry heat, blast, fire, water or smoke below decks to any damaging extent.

N. Ship Control.

(a) Damage to ship control stations and causes.

(1) Control stations on the bridge remained operative.

(2) C.I. C. was put out of action by the carrying away of all radar antennas.

(3) The gyro compasses and all but one of the repeaters remained operative.

(4) The steering gear was undamaged.

(5) The loudspeaker system and the telephone system remained operative.

O. Fire Control.

(a) The only fire control installed is the model 51 director sight for each 40 mm mount. The blast damaged the light metal sights of these. Flying objects and damaged mounting sites put them all out of use, except the one on the starboard side forward.

(b) These 40 mm controls have to be as exposed as the guns and are not essentially less rugged. There is no way to protect them at present.

P. Ammunition Behavior.

(a) Forty mm and twenty mm ammunition was not affected. Four ready ammunition stowages around the edges of the flight deck had 40mm in them. All remained undamaged.

SECRET

USS INDEPENDENCE (CVL22)

burned up. The original blast opened up this compartment and, evidently, the fire in that area later heated up the torpedoes enough to burn.

(c) It is obvious that C-101-B is not protected enough for war-head stowage.

(d) The gasoline stowage suffered no damage.

Q. Ammunition Handling.

(a) The only ammunition handling device aboard, is the bomb elevator. It was not damaged by the bombing but was out of commission because of lack of electrical power.

R. Strength.

(a) No hog or sag is evident.

(b) There is no shear strain.

(c) The stern was twisted to starboard, or clockwise looking forward. It is shown by the hull wrinkles mentioned in Item F.

S. Miscellaneous.

(a) Upon first coming aboard, four days after A day, little if any paint discoloration or shadow effect was noted. Upright stanchions on the forecastle had the paint raised in blisters on the port side but the paint was gray and showed no heat effect.

After several days it has been noted that the gray paint on the port side has been turning dark, almost black, and is all peeling. Red paint in Japanese flags painted on the island all turned white. Yellow paint in numerals on the flight deck has turned black except here it was protected by nearby equipment. There it remains yellow (July 13) and gives a good shadow indication. The unprotected wood on the flight deck did not show any heat effect at first. Now it is gradually blackening and after thirteen days looks distinctly charred.

SECRET

USS INDEPENDENCE (CVL22)

PART C - INSPECTION REPORT

SECTION B - MACHINERY

A. General Description of Machinery Damage.

(a) There was no machinery damage of major importance except to Item R - Elevators, Item W (a) Flight Deck Crane and (b) Catapult Machinery.

B. Boilers.

No comment.

C. Blowers.

No comment.

D. Fuel Oil Equipment.

No comment.

E. Boiler Feedwater Equipment.

No comment.

F. Main Turbines.

No comment.

G. Reduction Gears.

No comment.

H. Shafting and Bearing.

No comment.

SECRET

USS INDEPENDENCE (CVL22)

No comment.

J. Condensers and Air Ejectors.

No comment.

K. Pumps.

No comment.

L. Aux. Generators (Turbine and Gears).

No comment.

M. Propellers.

No comment.

N. Distilling Plant.

No comment.

O. Refrigerating Plant.

No comment.

P. Winches, Windlasses, and Capstans.

No comment.

Q. Steering Engine.

No comment.

R. Elevators, Ammunition Hoists, etc.

The elevator platforms were up level with the Flight Deck and both platforms were blown up and off, apparently without hitting

SECRET

USS INDEPENDENCE (CVL22)

the rams appear to be intact. The two sets of elevator machinery, pumps motors, etc., on the third deck appear to be undamaged.

S. Ventilation (Machinery).

No comment.

T. Air Compressors.

No comment.

U. Diesels (Generators and Boats).

No comment.

V. Piping.

No comment.

W. Flight Deck Crane.

(a) The ship developed a spin-like whip under the blast and shock. Objects of considerable inertia tended to remain in place while the ship vibrated past them. Examples are the large water filled tank placed by the Air Corps near the after elevator, the heavy parts of the Catapults and the Crane. The blast was from port, but the tank in the Flight Deck moved to port relative to the deck. The bolts in its supporting beams sheared in that direction and the mark of the edge of the tank shows plainly in the deck. When the ship rolled the tank slid off to starboard. Forward the whip was up and down, as well as athwartships. The Crane was bounced upward out of its bearings, shearing a ring of bolts or studs around the bearing at the bottom and, consequently, the king post now leans forward and outward at quite an angle. Other than being out of position the crane shows little damage.

SECRET

USS INDEPENDENCE (CVL22)

Under the port catapult, which is installed fore and aft, the deck whipped right and left. The very heavy motor-pump-tank unit tended to remain in place while the track moved with the deck. This relative motion sheared the holding down bolts holding the pump unit to the track and bent the track to starboard. On the reverse motion the pump unit bent its supports to port. Other than as stated the port catapult shows no damage.

The starboard catapult is installed athwartship. Its Air Flask and Oil Tank are both not well braced against a cross-ship motion. Both moved bending several pipes and shearing one with resulting oil leaks. There was no other damage.

SECRET

USS INDEPENDENCE (CVL22)

Page 272 of 280 Pages

PART C - INSPECTION REPORT

SECTION C - ELECTRICAL

A. General Description of Damage.

Nothing of much interest has turned up in Electrical Equipment. All equipment remained and continued to function except where it was removed with blown away structures or demolished by flying debris. The ships generators, both service and Diesel, all switchboards, lights, gyro compasses, automatic telephones, telegraph and the announcing system, were all working. The electrical equipment certainly shows that it has been well designed to withstand battle damage.

B. Electric Propulsion Rotating Equipment.

No comment.

C. Electric Propulsion Control Equipment.

No comment.

D. Generators - Ships Service.

No comment.

E. Generators - Emergency.

No comment.

F. Switchboards.

No comment.

G. Wiring, Wiring Equipment, and Wireways.

No comment.

SECRET

USS INDEPENDENCE (CVL22)

No comment.

I. Submarine Propelling Batteries.

No comment.

J. Portable Batteries.

No comment.

K. Motors.

No comment.

L. Lighting Equipment.

No comment.

M. Searchlights.

No comment.

N. Degaussing Equipment.

No comment.

O. Gyro Compass Equipment.

No comment.

P. Sound Powered Telephones.

No comment.

Q. Ships Service Telephones.

No comment.

SECRET

USS INDEPENDENCE (CVL22)

No comment.

S. Telegraphs.

No comment.

T. Indicating Systems.

No comment.

U. I.C. and A.C.O. Switchboards.

No comment.

V. F.C. Switchboards.

No comment.

SECRET

USS INDEPENDENCE (CVL 22)

Page 275 of 280 Pages

SECTION III

PART C - INSPECTION REPORT

SECTION D - ELECTRONICS

A. General Description of Electronic Damage.

(1) The Radar was put out of commission by the disappearance of all antennas. The sets in the C.I.C. room and in the bridge were relatively little damaged.

(2) Radio. Transmitting and receiving sets in Radio 1 and Radio 2 escaped damage. All antennas were demolished.

(3) No Sonar.

(4) Loran. The Loran set in the chart room was demolished by being thrown about and other objects being thrown into it.

B. Fire Control Radar.

No comment.

C. Surface Search Radar.

No comment.

D. Air Search Radar.

No comment.

E. Radar Repeaters.

No comment.

F. Radar Counter Measures Equipment.

No comment.

SECRET

USS INDEPENDENCE (CVL22)

No comment.

H. IFF Equipment.

No comment.

I. Communication Transmitters.

No comment.

J. Communication Receivers.

No comment.

K. Communication Antennae:

No comment.

L. Radio Transceivers.

No comment.

M. Sonar Echo Ranging and Listening Equipment.

No comment.

N. Sonar Echo Sounding Equipment and Altimeters.

No comment.

O. Loran Navigation Equipment.

No comment.

P. Power Supplies (Motor Generators and Filters.

No comment.

SECRET

USS INDEPENDENCE (CVL22)

No comment.

R. Test Equipment.

No comment.

S. Instrumentation.

No comment.

T. Telephone Equipment.

No comment.

U. Direction Finders (Radio).

No comment.

V. Spare Parts.

No comment.

SECRET

USS INDEPENDENCE (CVL22)

Page 278 of 280 Pages

OBSERVATIONS AND COMMENTS

1. Fortunately the bombs, gasoline and gassed airplanes did not enter into Secondary Damage which would have obscured the effects of the A bomb. The gassed airplanes on the stern did not have any effect on the fire in that section as they apparently were blown away in the initial blast. The special material on deck was all damaged but some parts of most pieces were recovered, so the display on the whole was successful. The stuff was there on the flight deck to show what the bomb would do to it, and it did show it.

2. There is no easy way to assess the affect of special conditions caused by the absence of personnel. The fire in the stern proceeded slowly and certainly could have been put out by a few persons. It burned for almost forty eight hours and did no major damage even then. On the other hand, twelve of the airplanes on board had no gas in them. This was arranged because no personnel would be on hand to fight a gasoline fire. If they had been full of gasoline there would have been fire all over the ship because the airplanes were torn to rags both on deck and in the hangar.

3. The results of the medical observation of below decks, animals is not known, so whether or not any of the crew would have survived after some days is also not known. Certainly everyone on weather and hangar decks would have been killed and blown overboard. There would have been many other casualties in the interior due to pressure, shock and collisions. It is believed that at least seventy-five percent of the crew would have been killed or injured immediately during daylight hours. Since the living quarter below decks were damaged relatively much less, casualties would have been much smaller at night.

4. A completely enclosed ship possibly would have suffered less damage under the same conditions. Quarter-inch plate supported about as strongly as that forming the "island" would probably

SECRET

USS INDEPENDENCE (CVL22)

flight deck, provided the openings at the elevators were also closed. External doors all were blown inwards, allowing the pressure to enter and do further damage. The doors did not match the strength of the walls they were a part of. The value of self-closing doors to shut off smoke pipes at a strong point was demonstrated by the collapse of the uptakes at the hangar deck level. The openings were thus sealed at this level and all boilers escaped undamaged. Internal doors which would bang shut under outside pressure are worth considering because other ships are said to have had extensive damage from pressure which entered via a stack.

CONFIDENTIAL

Classification (~~General~~) (Changed to
By Authority of Joint Chiefs of Staff (Action 15 Apr 49)

By *James H. Doolittle* Date *24 Apr 51*
W. H. A. S. P.



CONFIDENTIAL

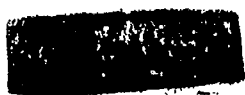

USS INDEPENDENCE (CVL22)



Defense Special Weapons Agency
6801 Telegraph Road
Alexandria, Virginia 22310-3398

TRC

9 April 1997

MEMORANDUM FOR DEFENSE TECHNICAL INFORMATION CENTER
ATTENTION: OMI/Mr. William Bush

SUBJECT: Declassification of Reports

The Defense Special Weapons Agency (formerly Defense Nuclear Agency) Security Office has reviewed and declassified the following reports:

+ ST-A

AD-366748 -	XRD-65
AD-366747 ~	XRD-64
AD-366746 ^	XRD-63
AD-376826 ~	XRD-60
AD-376824 ~	XRD-58
AD-376825 -	XRD-59
AD-376823 -	XRD-57
AD-376822 -	XRD-56
AD-376821 -	XRD-55
AD-366743 ~	XRD-54
AD-376820 ~	XRD-53
AD-366742 ~	XRD-52
AD-366741 ~	XRD-51
AD-366740 -	XRD-50-Volume-2
AD-366739 -	XRD-49-Volume-1
AD-366738 -	XRD-48
AD-366737 ^	XRD-47

TRC

9 April 1997

SUBJECT: Declassification of Reports

AD-366736 -	XRD-46
AD-366735 -	XRD-45
AD-366723 -	XRD-37
AD-366721 -	XRD-35
AD-366717 -	XRD-31-Volume-2
AD-366716 -	XRD-30-Volume-1
AD-366751 -	XRD-68-Volume-2
AD-366750 -	XRD-67-Volume-1
AD-366752 -	XRD-69
AD-366744 -	XRD-61.

All of the cited reports are now **approved for public release**. **Distribution statement "A"** now applies.

Ardith Jarrett
ARDITH JARRETT
Chief, Technical Resource Center

*Completed
1 mar 2000
B.W.*